

US00D620087S

(12) **United States Design Patent**
Clark

(10) **Patent No.:** **US D620,087 S**

(45) **Date of Patent:** **** Jul. 20, 2010**

(54) **GUTTER SYSTEM**

(76) Inventor: **Kevin Clark**, 1535 Highway 50, Delta,
CO (US) 81416

(**) Term: **14 Years**

(21) Appl. No.: **29/327,253**

(22) Filed: **Nov. 3, 2008**

(51) **LOC (9) Cl.** **23-01**

(52) **U.S. Cl.** **D23/267**

(58) **Field of Classification Search** D23/259-269;
52/11-13, 16; 248/48.1; 404/4-5, 2; 405/118;
D25/119

See application file for complete search history.

(56) **References Cited**

U.S. PATENT DOCUMENTS

D244,257	S	*	5/1977	Godo et al.	D9/660
4,156,892	A	*	5/1979	Fisher	362/123
D261,539	S	*	10/1981	Smith	D21/725
4,634,613	A	*	1/1987	Potter	428/20
D340,003	S	*	10/1993	Wright et al.	D11/118
D343,117	S	*	1/1994	Mansau	D9/658
5,361,793	A	*	11/1994	Stahnke	135/65
5,413,248	A	*	5/1995	Scott	222/51
D381,777	S	*	7/1997	Tuck	D30/121
D385,128	S	*	10/1997	Jing	D6/412
D398,612	S	*	9/1998	Juengert et al.	D14/238
D406,248	S	*	3/1999	Prineppi	D11/121
D410,975	S	*	6/1999	von Oppen	D21/496
5,915,582	A	*	6/1999	Wawzonek	220/23.4

D461,523	S	*	8/2002	Chen	D23/214
6,596,353	B1	*	7/2003	Turner	428/18
D499,558	S	*	12/2004	McGahee	D5/62
D508,762	S	*	8/2005	Jia et al.	D1/199
D513,453	S	*	1/2006	Ellis et al.	D5/62
D531,539	S	*	11/2006	Barthelmess	D11/118
D552,720	S	*	10/2007	Salatino et al.	D23/266
D577,424	S	*	9/2008	Clark	D23/266

* cited by examiner

Primary Examiner—T. Chase Nelson

Assistant Examiner—Eric L Goodman

(74) *Attorney, Agent, or Firm*—Crossley Patent Law; Mark A. Crossley

(57) **CLAIM**

The ornamental design for a gutter system, as shown and described.

DESCRIPTION

FIG. 1 is a front elevation view of a gutter system showing my new design;

FIG. 2 is a rear elevation view thereof;

FIG. 3 is a right elevation view thereof;

FIG. 4 is a left elevation view thereof;

FIG. 5 is a top plan view thereof; and,

FIG. 6 is a bottom plan view thereof.

The broken lines define the boundaries of the claimed design, and form no part thereof.

1 Claim, 4 Drawing Sheets

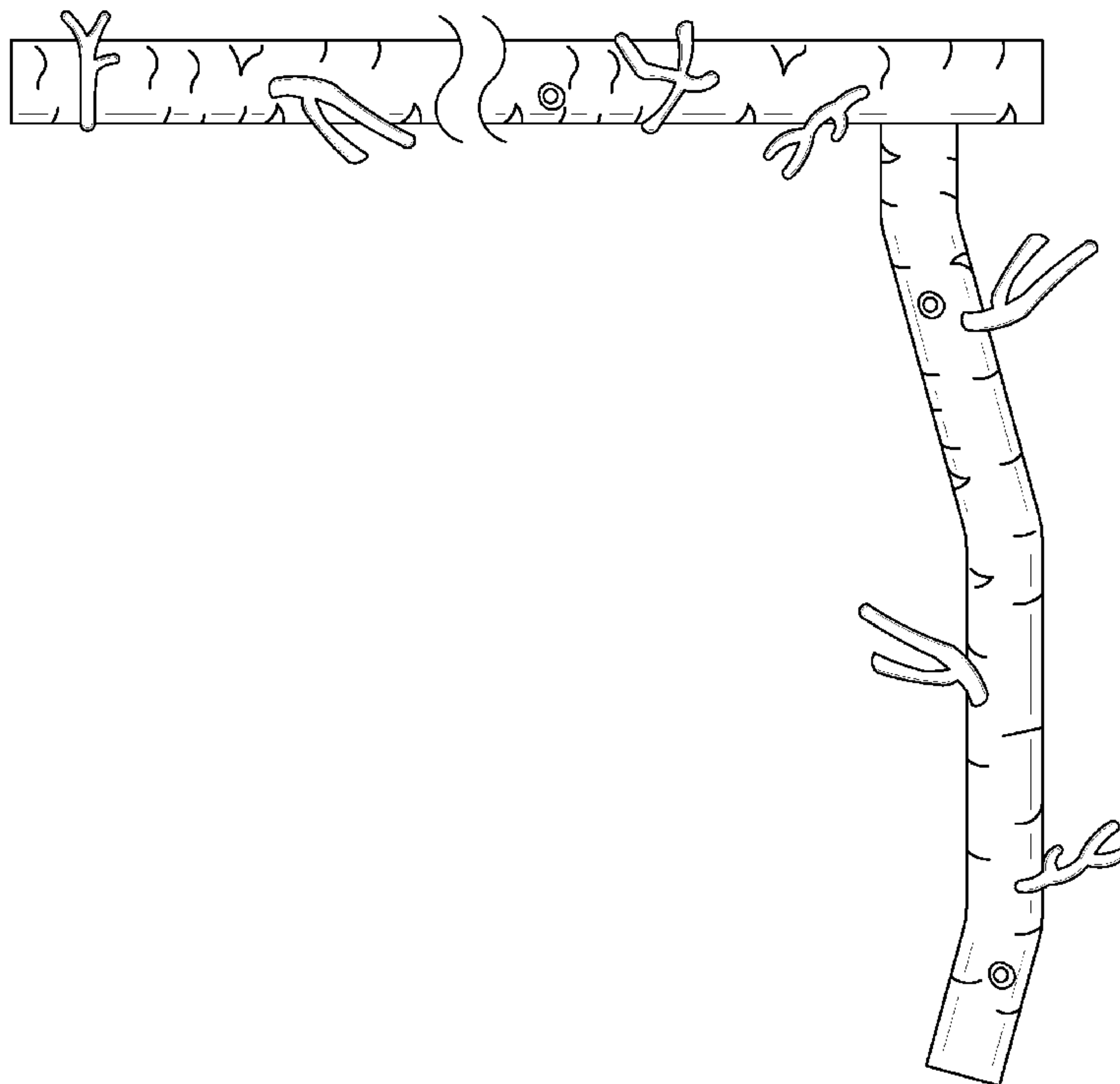

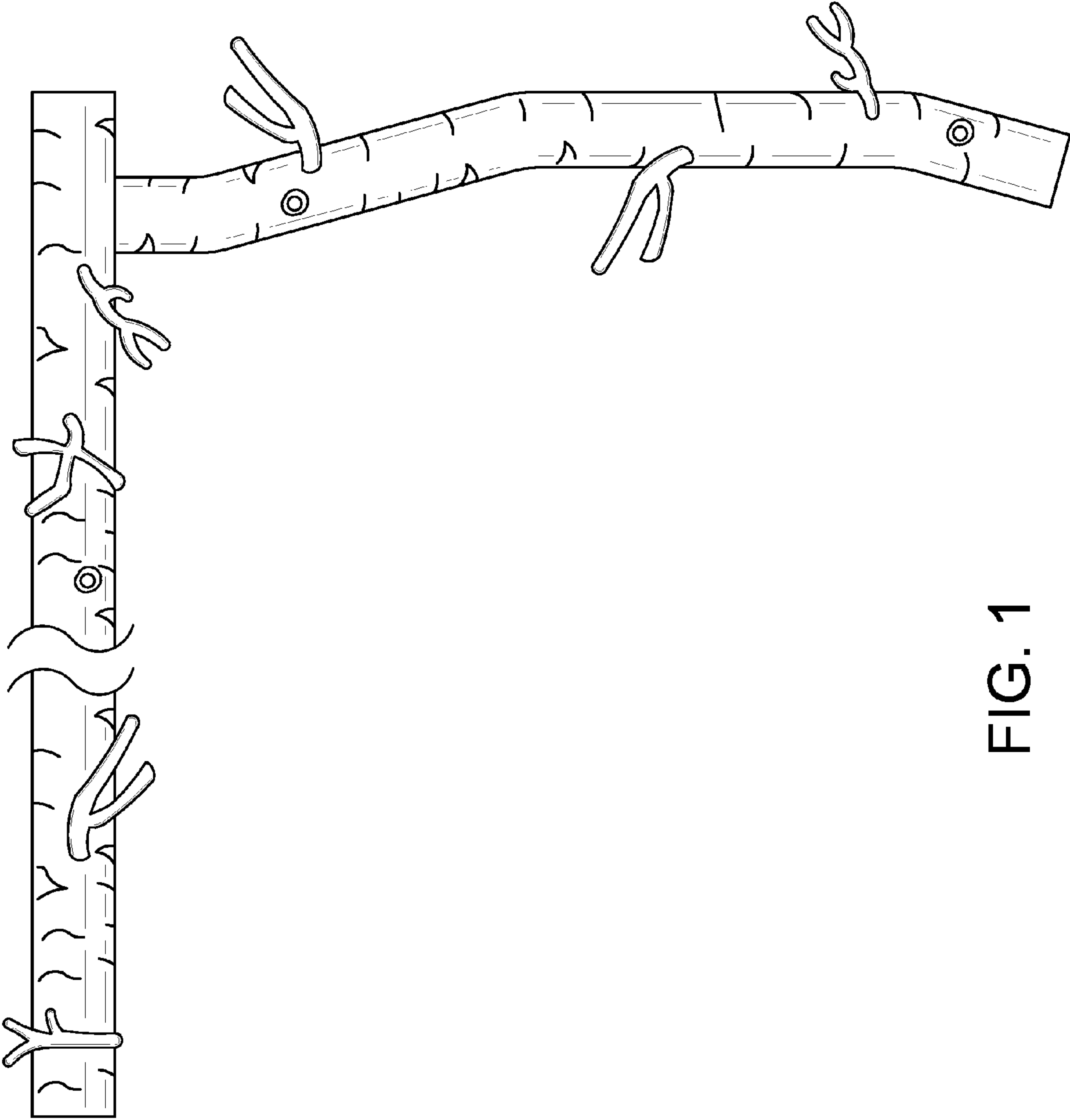

FIG. 1

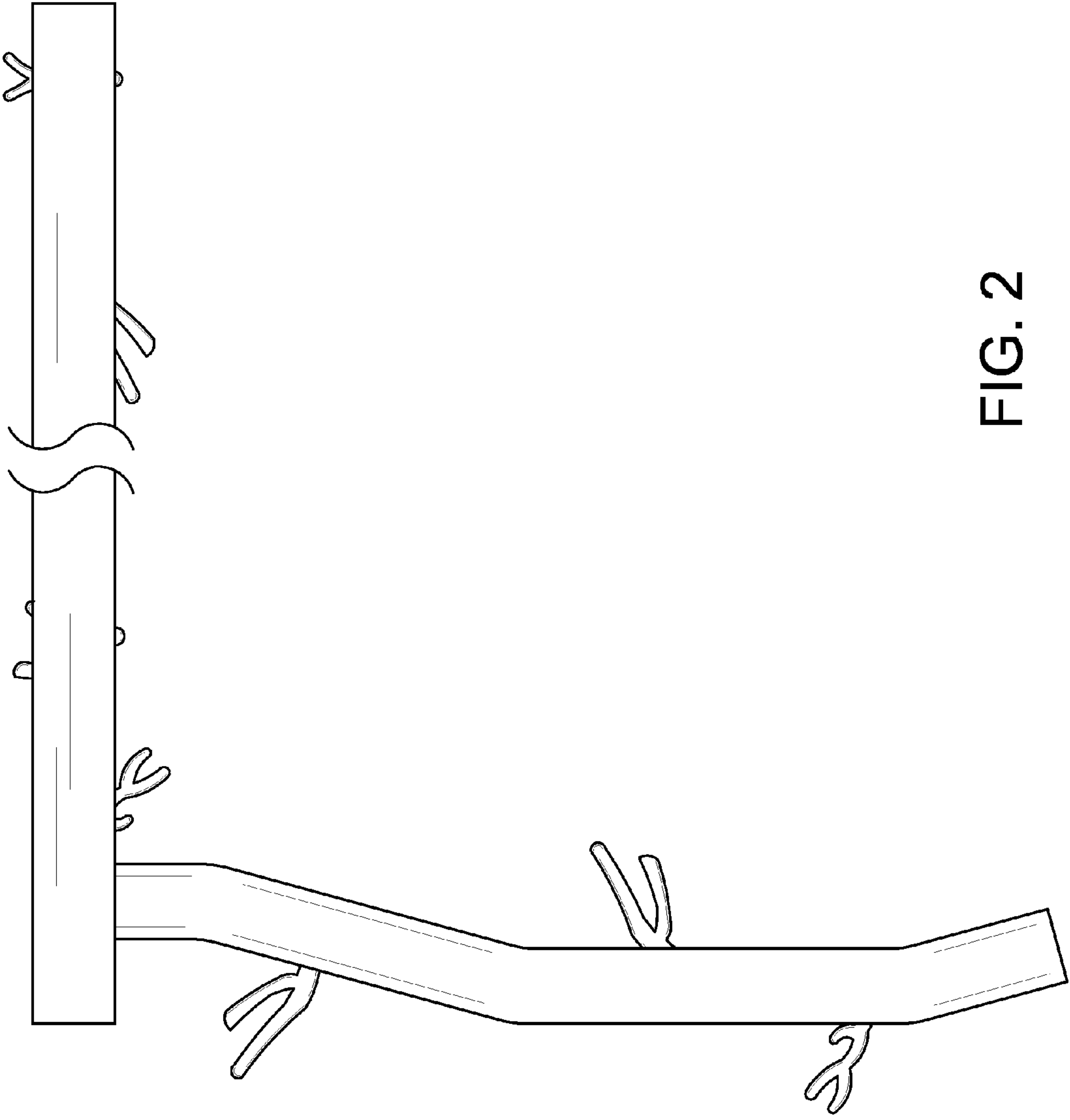

FIG. 2

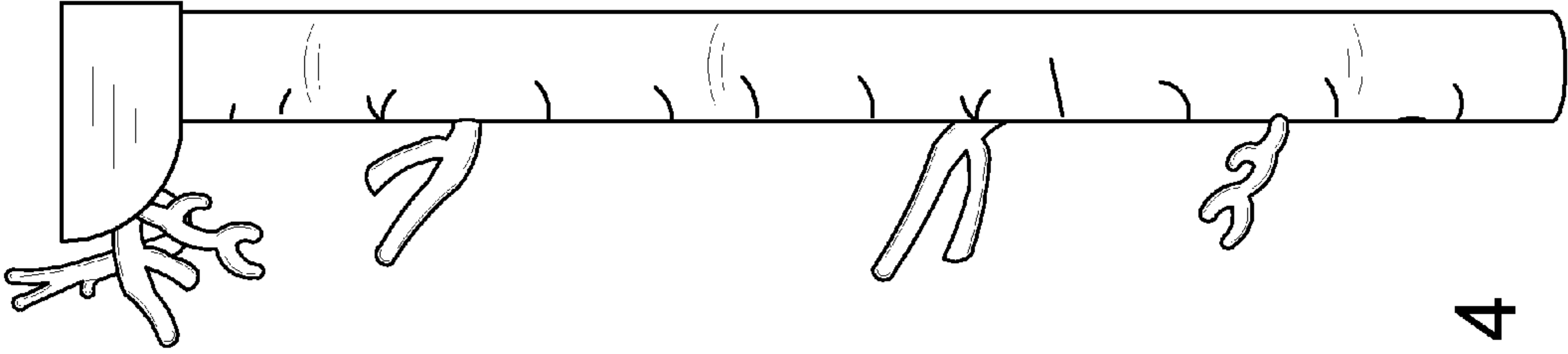

FIG. 4

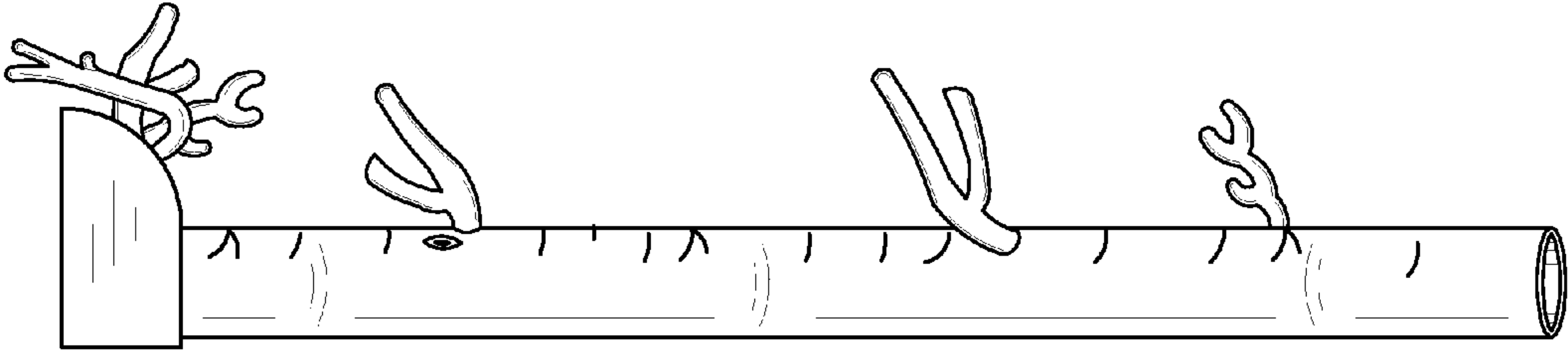

FIG. 3

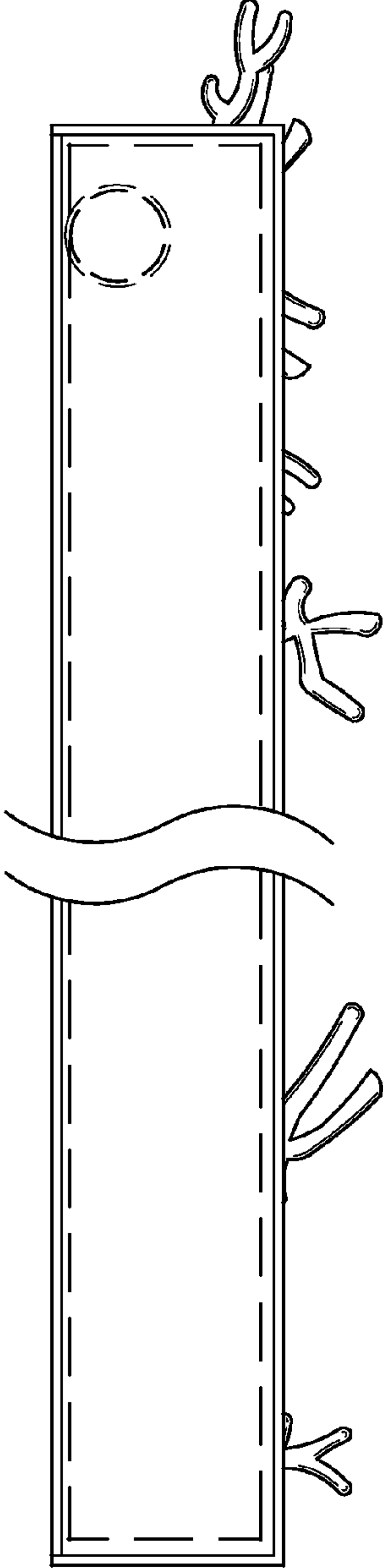

FIG. 5

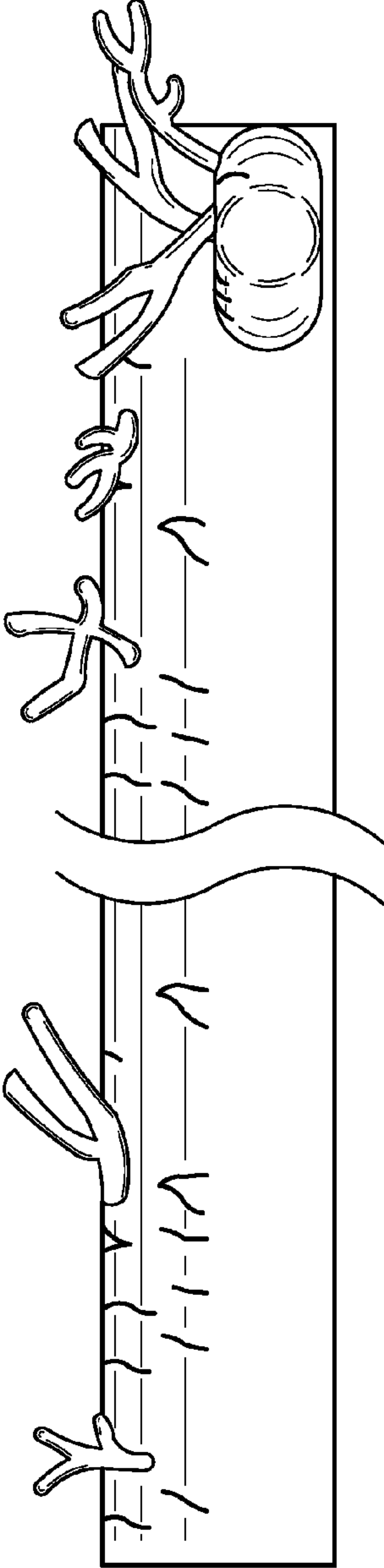

FIG. 6