



US00D620048S

(12) **United States Design Patent**
Lien

(10) **Patent No.:** **US D620,048 S**

(45) **Date of Patent:** **** Jul. 20, 2010**

(54) **PIN HEAD**

(76) **Inventor:** **Chin-Hsiung Lien**, 11561 Hallward Dr.,
El Monte, CA (US) 91732

(**) **Term:** **14 Years**

(21) **Appl. No.:** **29/348,697**

(22) **Filed:** **Jan. 29, 2010**

(51) **LOC (9) Cl.** **19-02**

(52) **U.S. Cl.** **D19/65**

(58) **Field of Classification Search** D8/395,
D8/356; D3/249; D19/78, 75, 65, 90, 77,
D19/86; 411/473, 429, 401; 362/190; 248/216.1
See application file for complete search history.

(56) **References Cited**

U.S. PATENT DOCUMENTS

1,991,561	A *	2/1935	Krantz	411/473
2,819,668	A *	1/1958	McAneny	101/125
D249,725	S *	9/1978	Cosman	D21/386
4,897,007	A *	1/1990	Chen et al.	411/401
6,132,060	A *	10/2000	Gallo	362/190
D450,092	S *	11/2001	Guillot	D19/90
D466,937	S *	12/2002	Kochlefl et al.	D19/65
6,668,501	B2 *	12/2003	Adebar et al.	52/363

D503,432	S *	3/2005	Huang	D19/90
D507,306	S *	7/2005	Siegel	D19/90
D508,533	S *	8/2005	Siegel	D19/90
D534,061	S *	12/2006	Sakai	D8/373
D582,481	S *	12/2008	Vaughn	D19/65

* cited by examiner

Primary Examiner—Cathron C Brooks

Assistant Examiner—Austin Murphy

(74) *Attorney, Agent, or Firm*—Raymond Y. Chan; David and Raymond Patent Firm

(57) **CLAIM**

The ornamental design for a pin head, as shown and described.

DESCRIPTION

FIG. 1 is a top perspective view of pin head showing my new design.

FIG. 2 is a top view thereof.

FIG. 3 is a bottom view thereof.

FIG. 4 is a side view thereof which is the same as the rear, left, right view of the invention; and,

FIG. 5 is a bottom perspective view thereof.

1 Claim, 5 Drawing Sheets

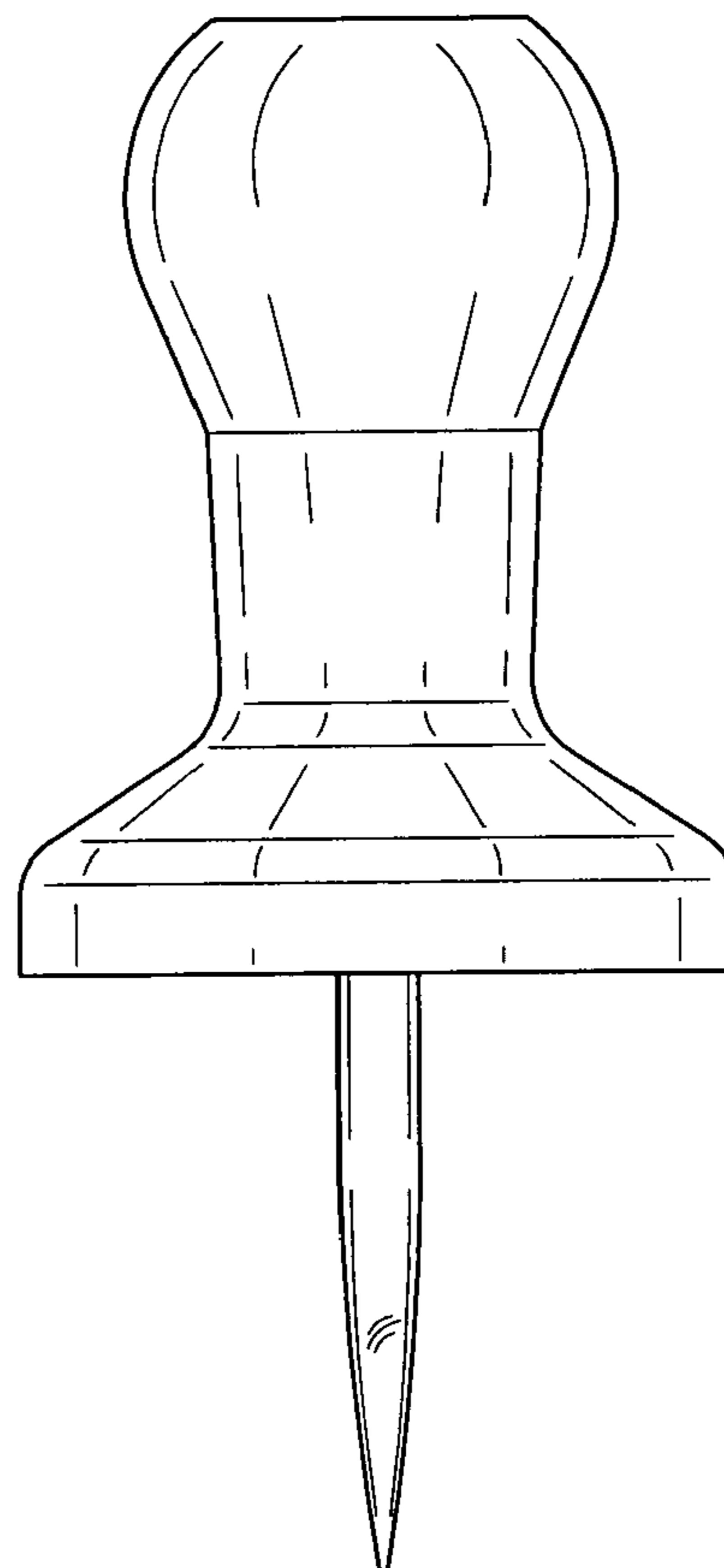
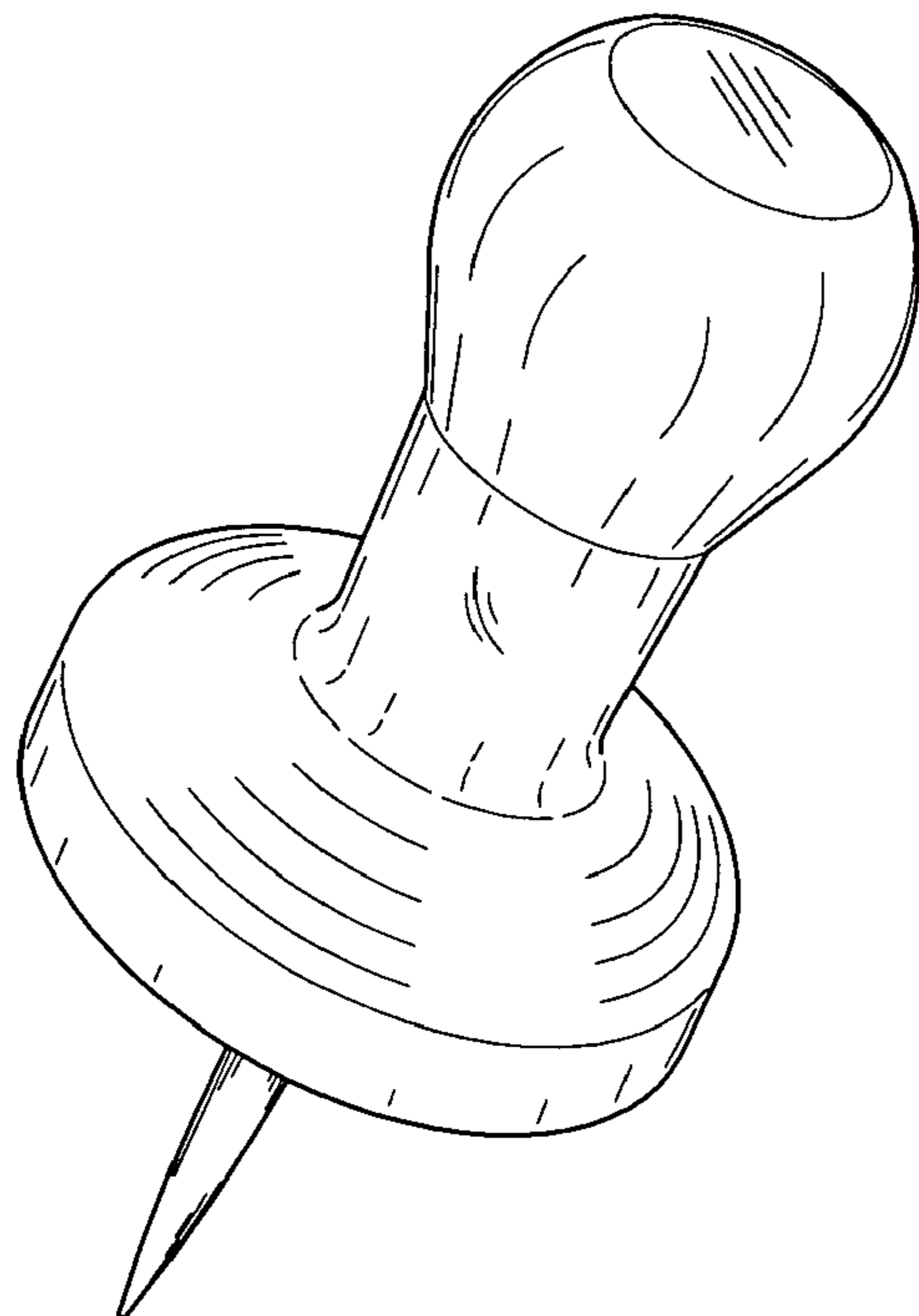

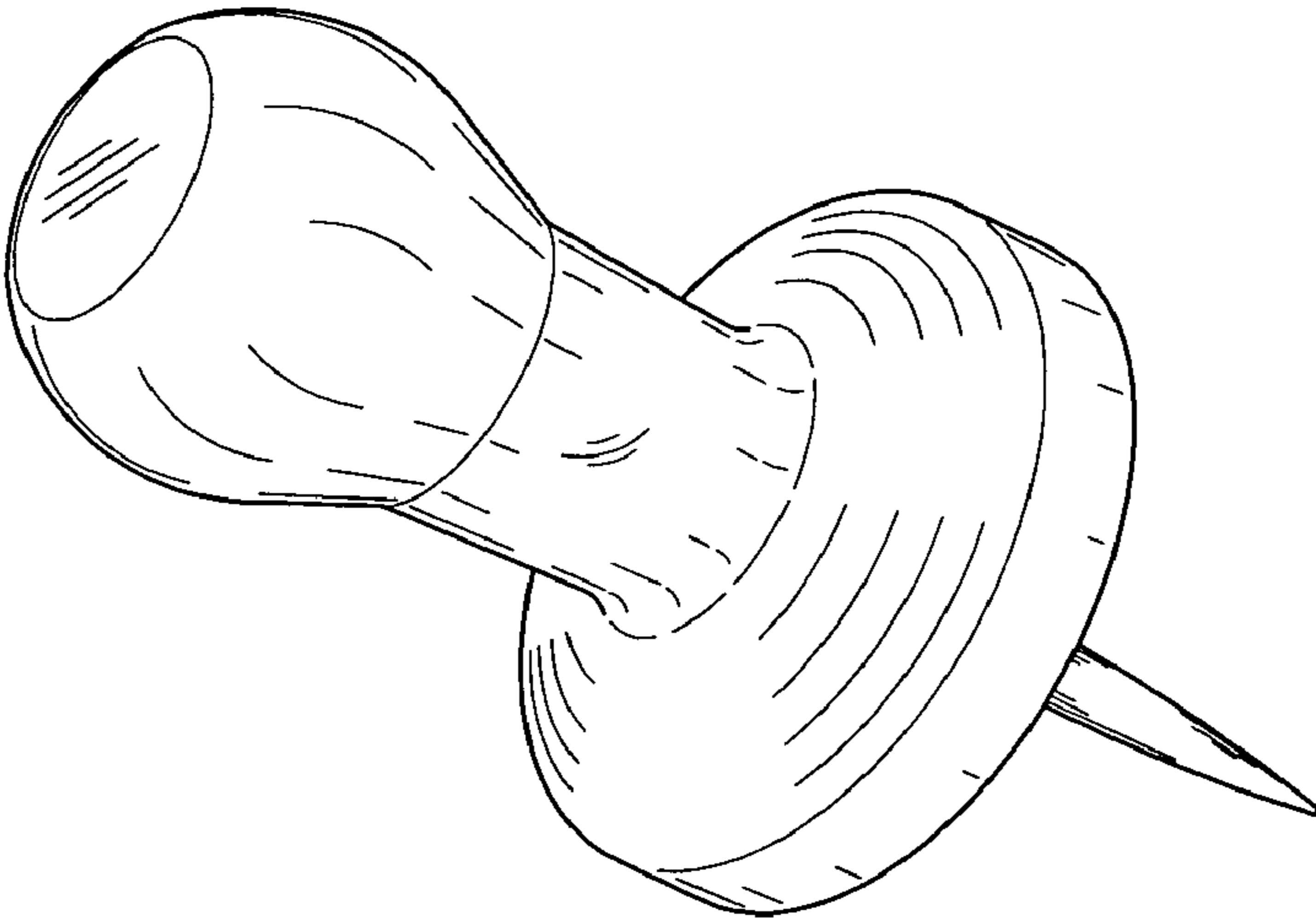

FIG.1

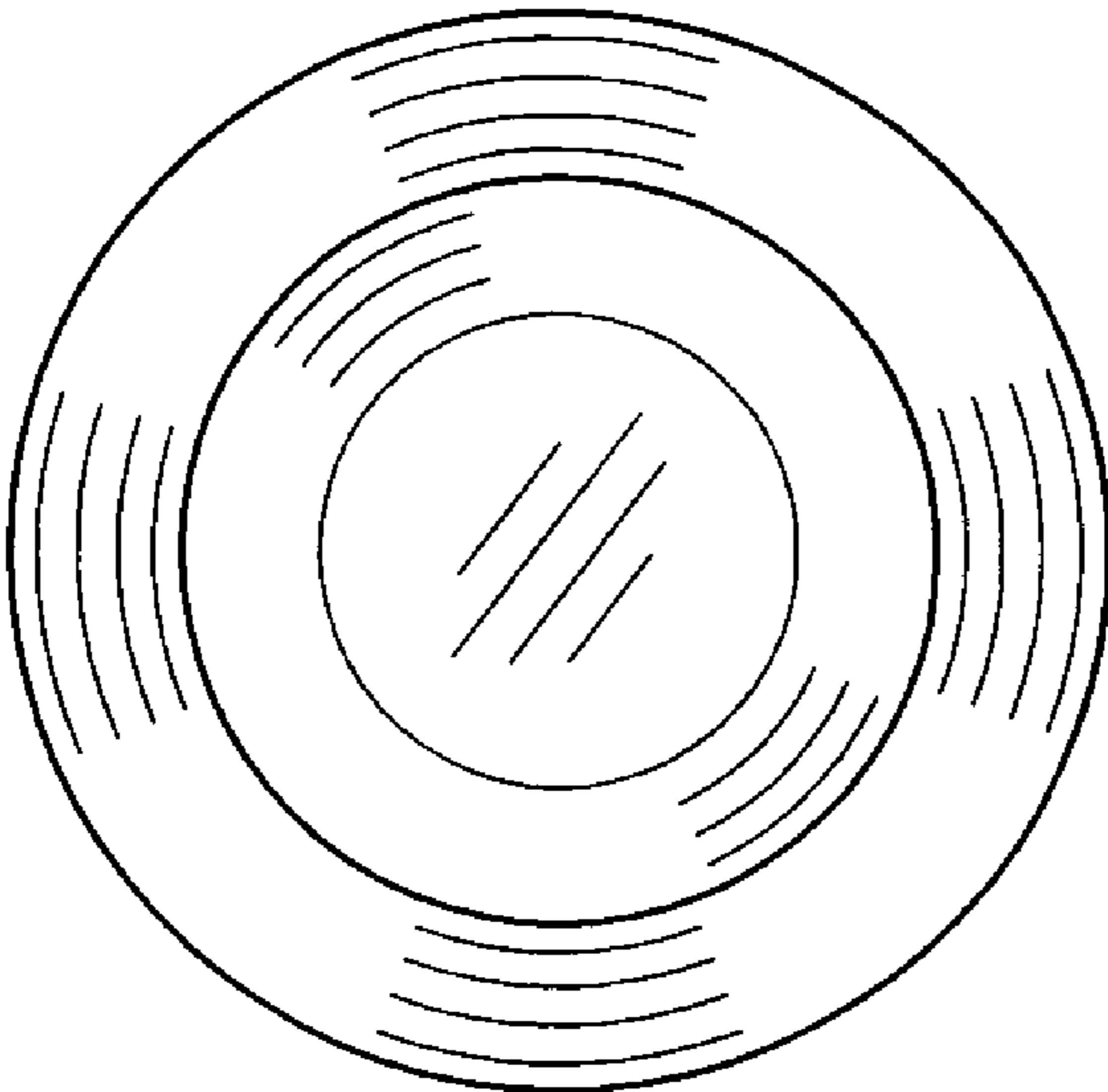

FIG.2

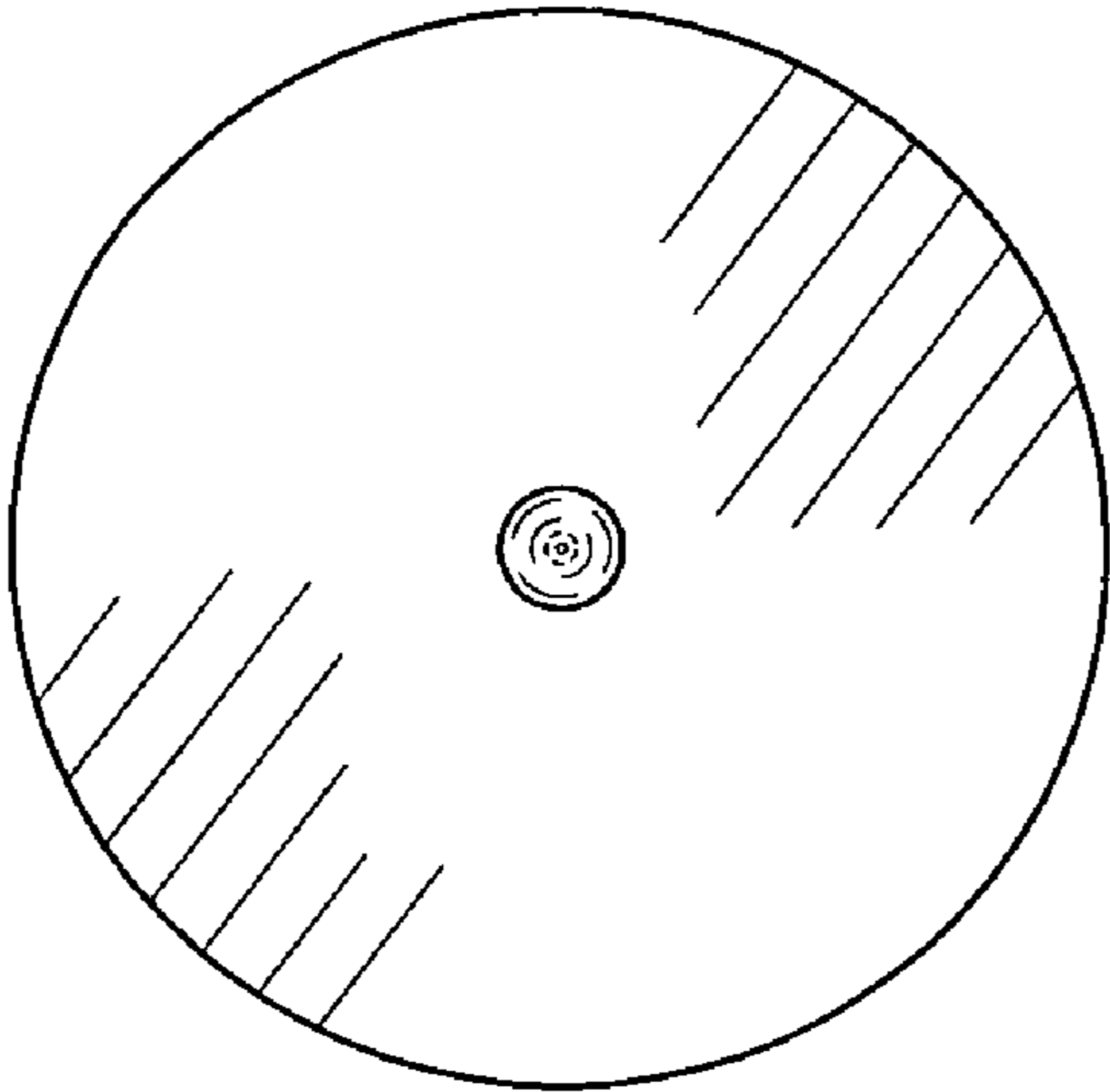

FIG.3

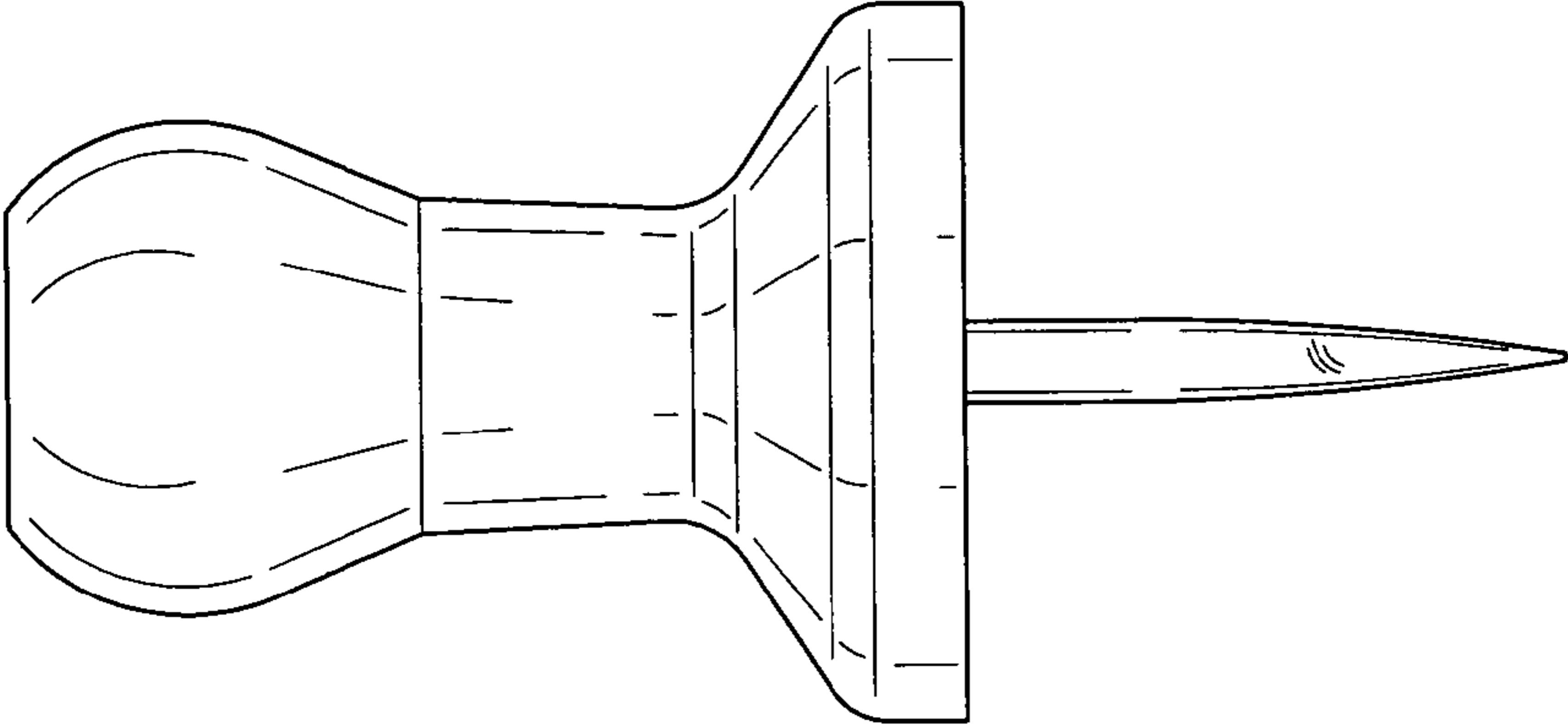

FIG.4

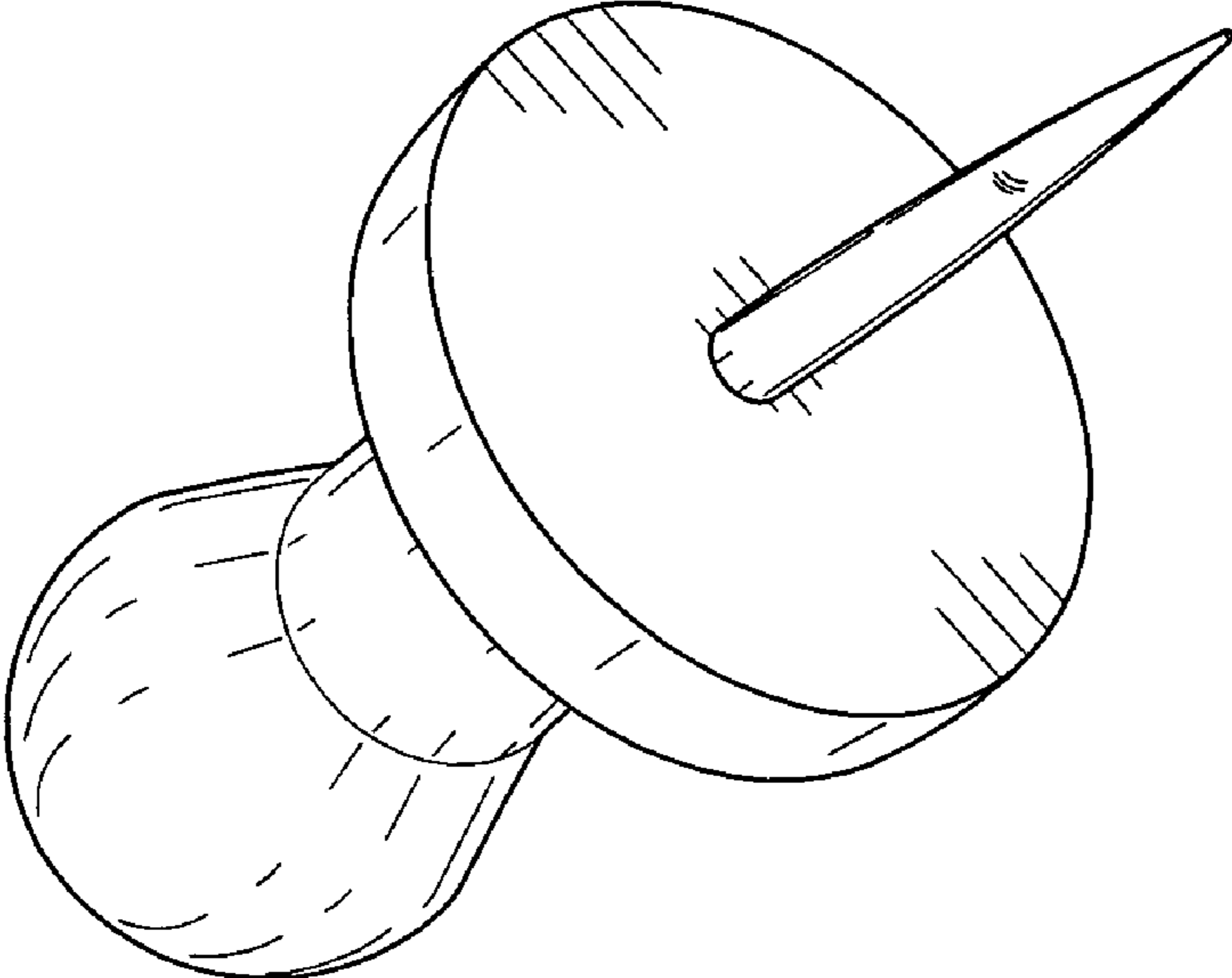

FIG.5