



US00D619919S

(12) **United States Design Patent**  
**Harding**

(10) **Patent No.:** **US D619,919 S**  
(45) **Date of Patent:** **\*\* Jul. 20, 2010**

(54) **FORTUNE KEEPSAKE PENDANT  
NECKLACE**

*Primary Examiner*—Ralf Seifert  
(74) *Attorney, Agent, or Firm*—QuickPatents, Inc.; Kevin Prince

(76) **Inventor:** **Christine Harding**, 26381 Lombardy Rd., Mission Viejo, CA (US) 92692

(57) **CLAIM**

(\*\*) **Term:** **14 Years**

I claim the ornamental design for a fortune keepsake pendant necklace, as shown and described.

(21) **Appl. No.:** **29/351,532**

(22) **Filed:** **Dec. 7, 2009**

(51) **LOC (9) Cl.** ..... **02-01**

(52) **U.S. Cl.** ..... **D11/80**

(58) **Field of Classification Search** ..... D11/1–2,  
D11/40–41, 43–50, 53, 56, 60, 63, 65, 67,  
D11/75–78.1, 86, 89, 95–105, 108–109, 115–116;  
63/1.11, 1.12, 1.13, 1.14, 1.16, 1.18, 13,  
63/14.1, 35, 38, 39

See application file for complete search history.

**DESCRIPTION**

FIG. 1 is a perspective view of a fortune keepsake pendant necklace, illustrated in a closed configuration, showing my new design;

FIG. 2 is a perspective view thereof, illustrated in an open configuration;

FIG. 3 is a rear elevational view thereof, illustrated in the open configuration;

FIG. 4 is a front elevational view thereof, illustrated in the open configuration;

FIG. 5 is a left-side elevational view thereof, illustrated in the open configuration;

FIG. 6 is a right-side elevational view thereof, illustrated in the open configuration;

FIG. 7 is a top plan view thereof, illustrated in the open configuration; and,

FIG. 8 is a bottom plan view thereof, illustrated in the open configuration.

The broken lines showing a chain and a fortune-cookie paper insert in FIG. 1 are included for the purpose of illustrating the invention in use, and form no part of the claimed design.

(56) **References Cited**

**U.S. PATENT DOCUMENTS**

144,153	A	*	10/1873	Smith	.....	63/18
2,176,253	A	*	10/1939	Fogarty	.....	40/661.06
D172,505	S	*	6/1954	Katz	.....	D11/80
D249,339	S	*	9/1978	Coulthurst	.....	D11/79
D266,555	S	*	10/1982	McNally	.....	D11/80
D282,055	S	*	1/1986	Brinkers	.....	D11/80
D306,707	S	*	3/1990	Henry De Frahan	.....	D11/79
D310,600	S	*	9/1990	Holterscheidt	.....	D3/207
D311,356	S	*	10/1990	De Frahan	.....	D11/79
D324,954	S	*	3/1992	Lewis	.....	D3/208
D332,007	S	*	12/1992	McAullay	.....	D3/212
D340,005	S	*	10/1993	Butler, Jr.	.....	D11/80
D493,493	S	*	7/2004	Howard	.....	D20/27
D575,663	S	*	8/2008	Hayden	.....	D11/79
D586,253	S	*	2/2009	Forster, Jr.	.....	D11/80

\* cited by examiner

**1 Claim, 4 Drawing Sheets**

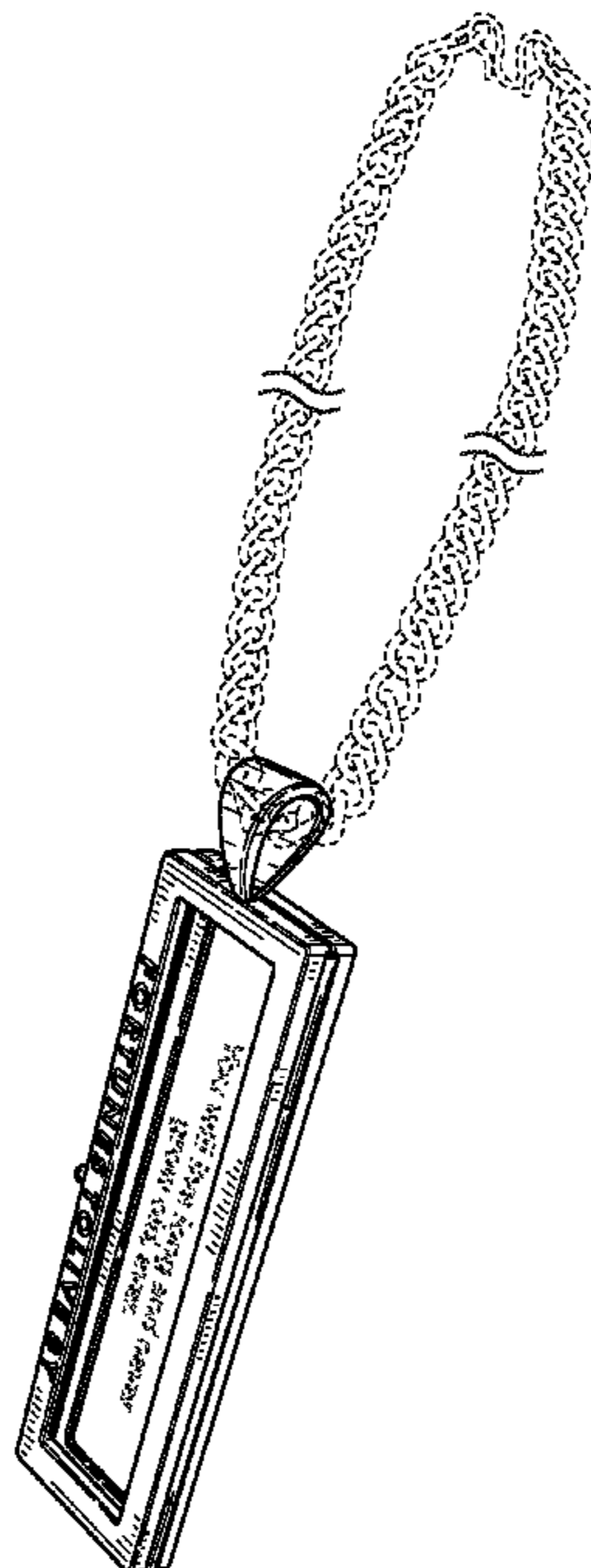

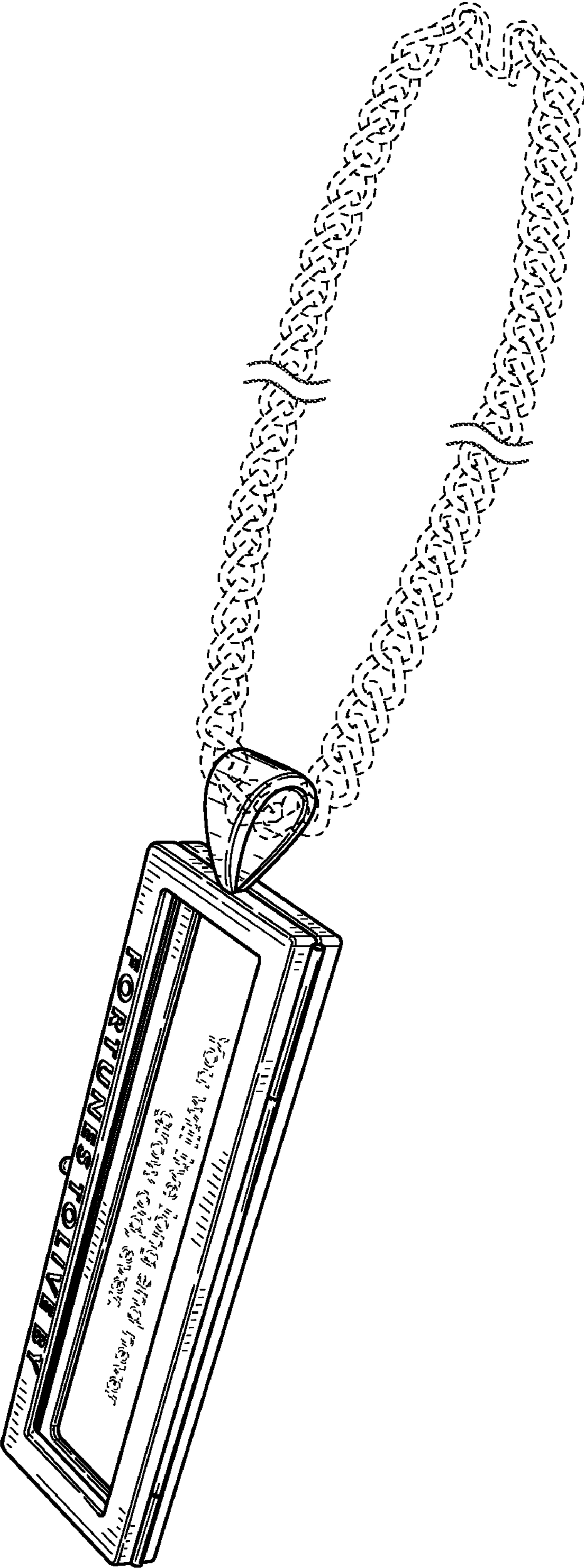

FIG. 1

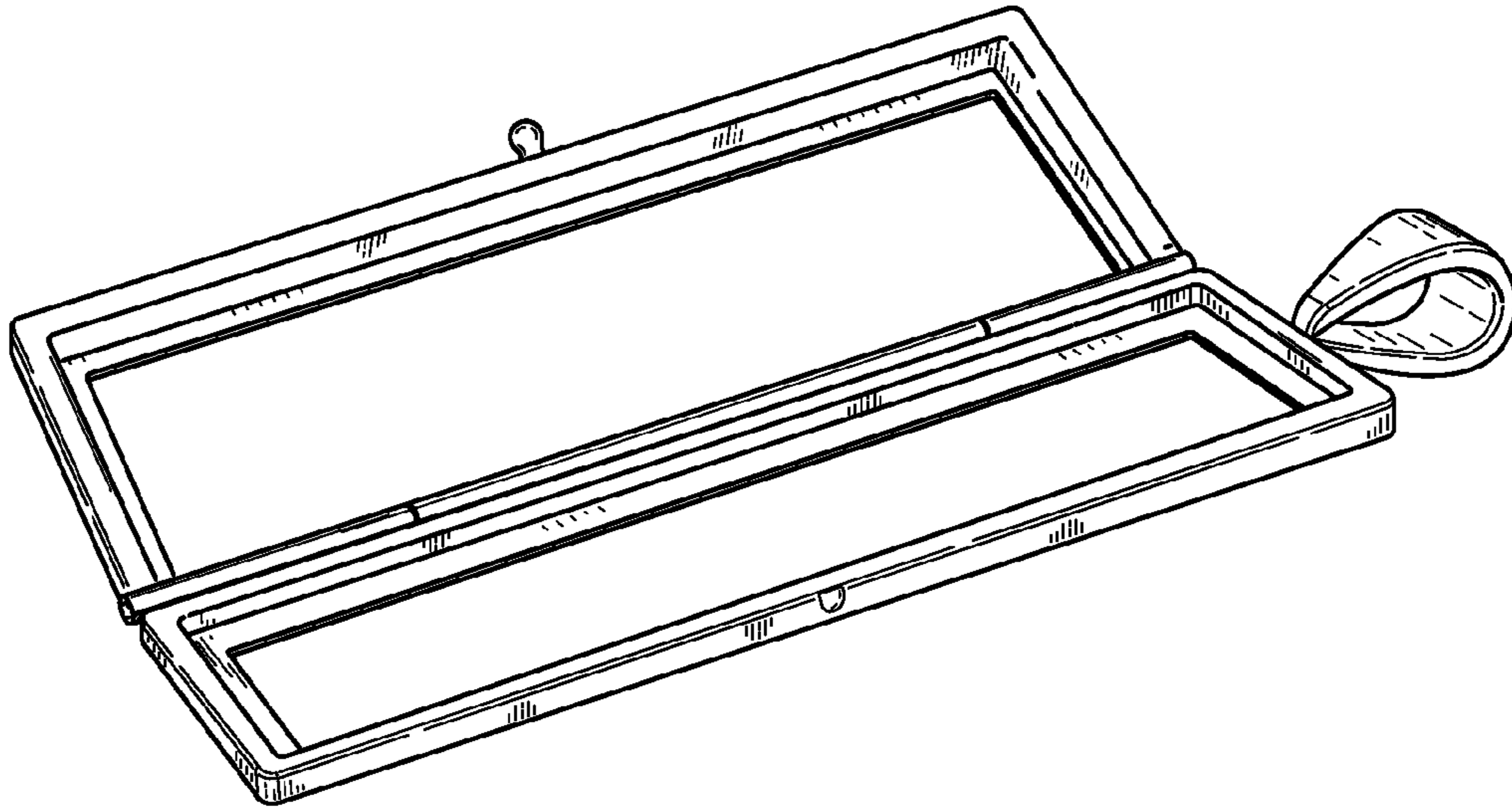

FIG. 2

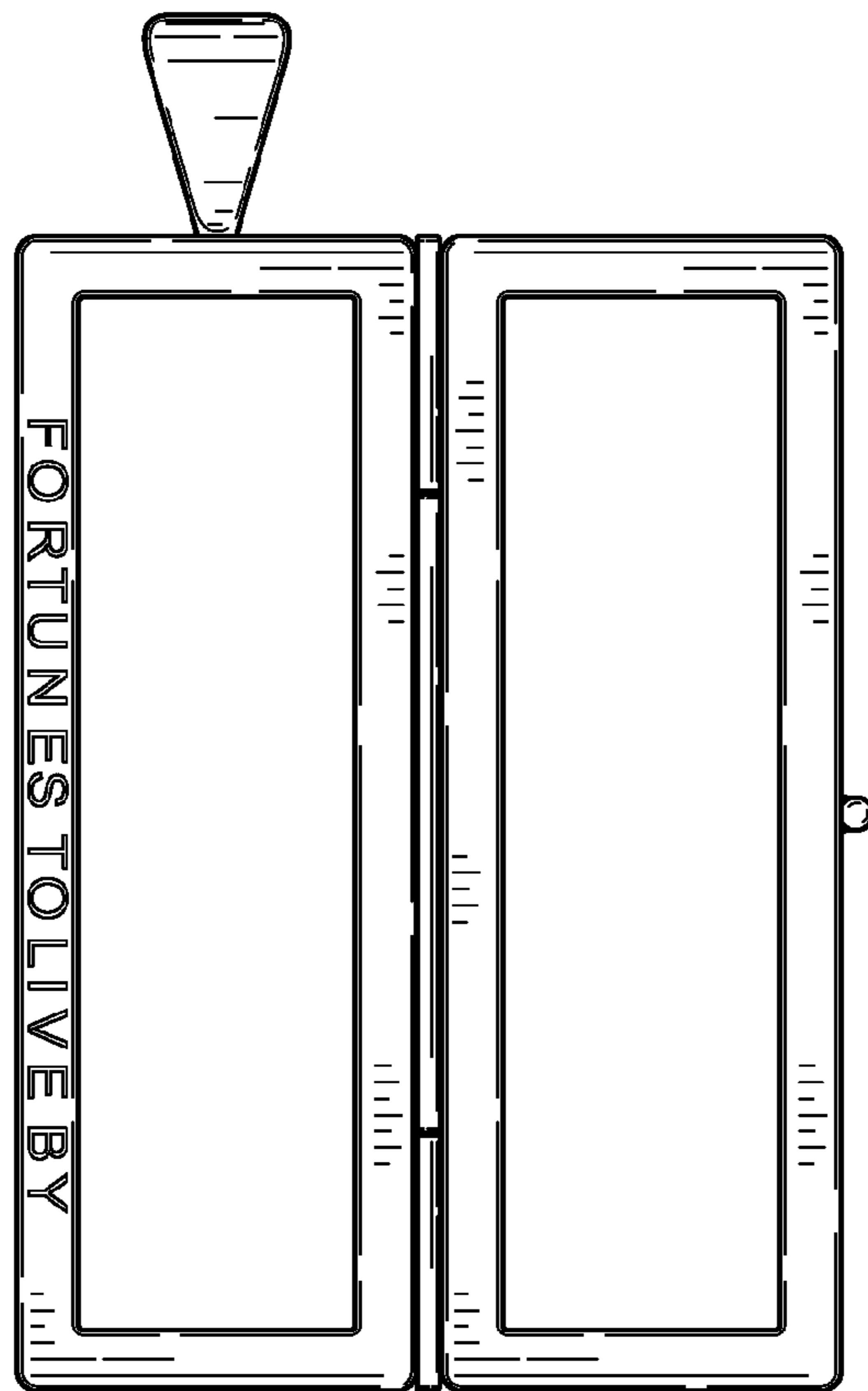

FIG. 3

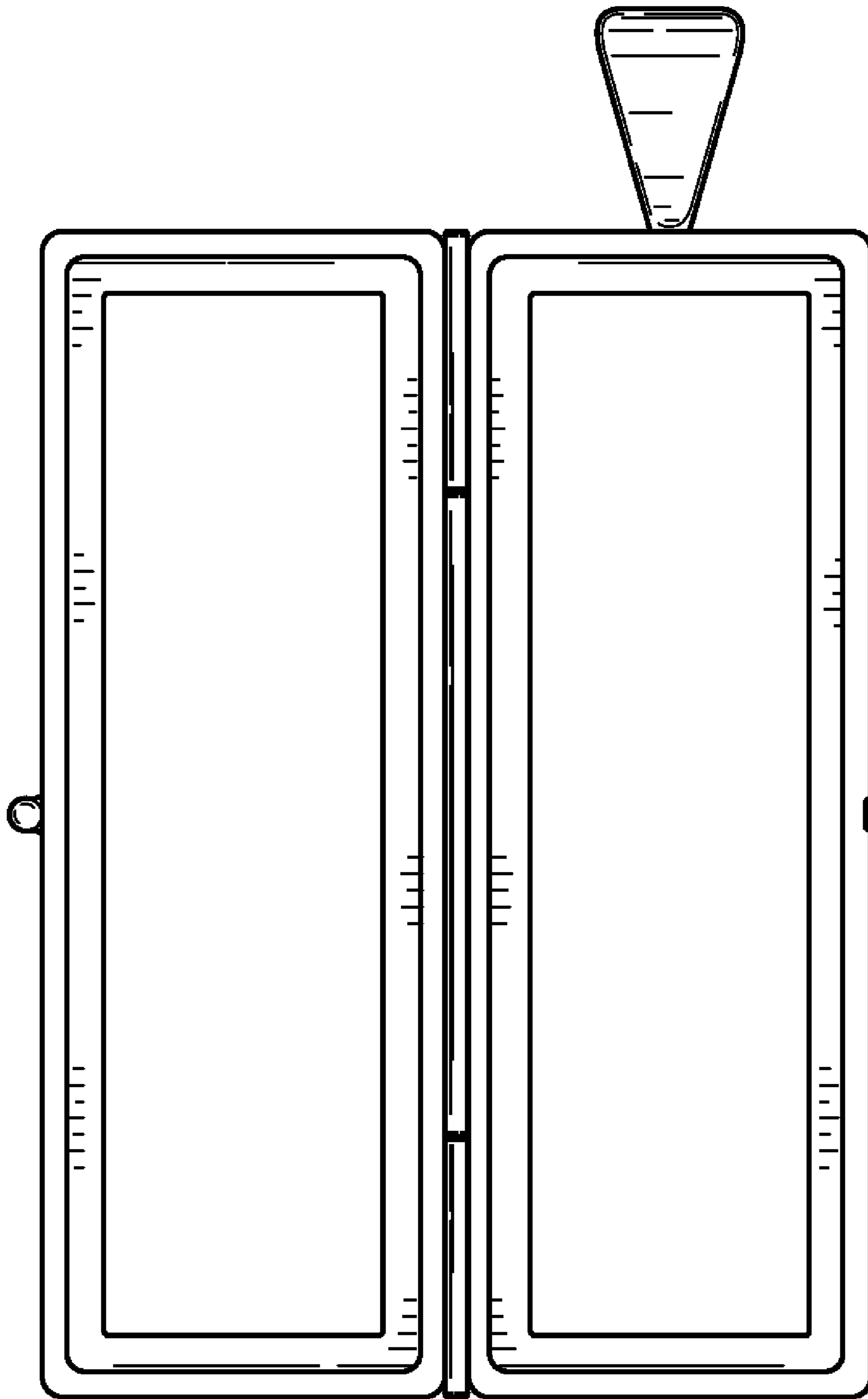

FIG. 4

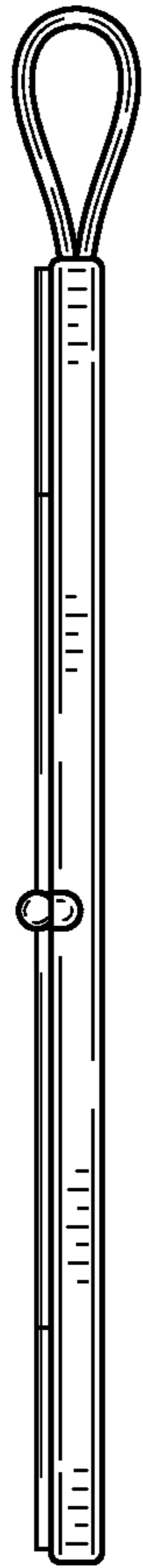

FIG. 5

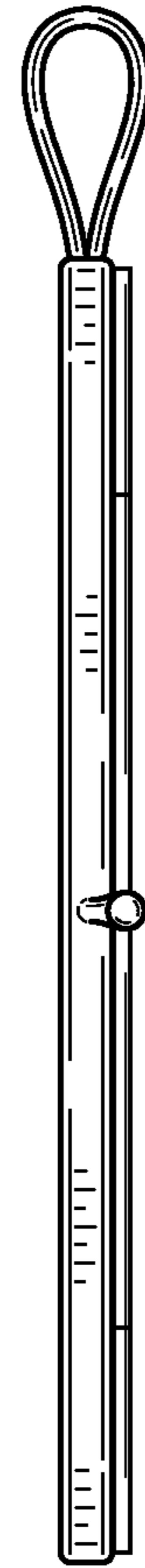

FIG. 6

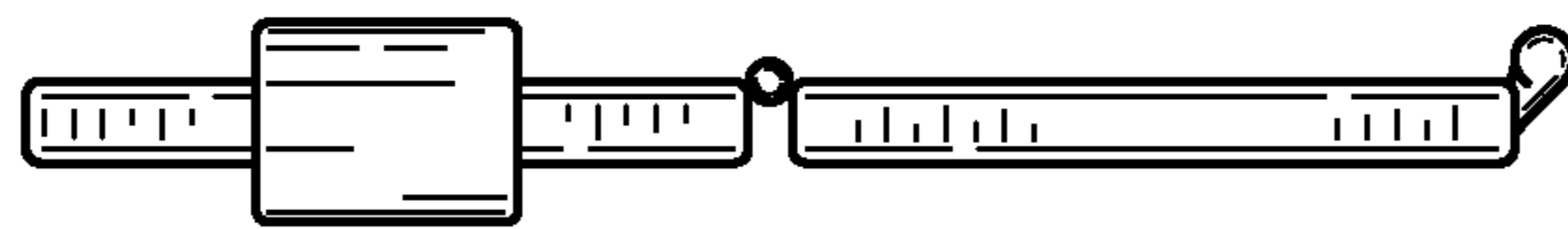

FIG. 7

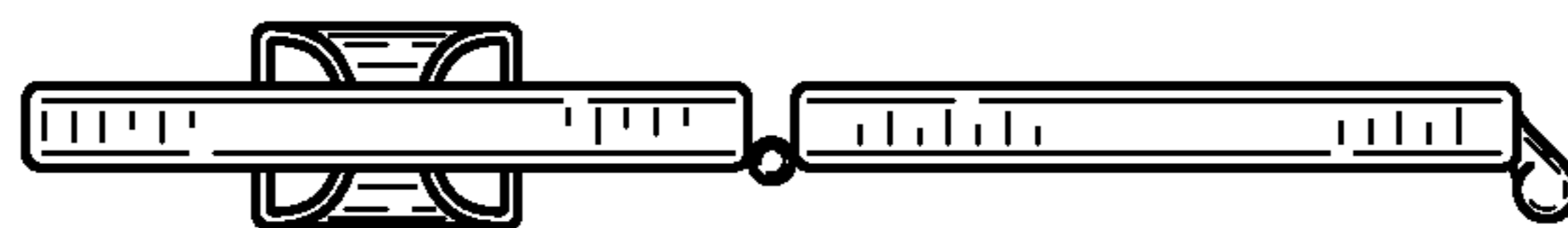

FIG. 8