



US00D619836S

(12) **United States Design Patent**
Kim

(10) **Patent No.:** **US D619,836 S**
(45) **Date of Patent:** **** Jul. 20, 2010**

(54) **TOWEL DISPENSER**

D447,372 S 9/2001 Fisscher
D447,373 S 9/2001 Fisscher
D447,657 S 9/2001 Fisscher

(75) Inventor: **Hyunchul Kim**, Chicago, IL (US)

(Continued)

(73) Assignee: **Georgia-Pacific Consumer Products LP**, Atlanta, GA (US)

Primary Examiner—Brian N Vinson
(74) *Attorney, Agent, or Firm*—Joel T. Charlton

(**) Term: **14 Years**

(57) **CLAIM**

(21) Appl. No.: **29/350,301**

The ornamental design for a towel dispenser, as shown and described.

(22) Filed: **Nov. 13, 2009**

(51) **LOC (9) Cl.** **20-02**

DESCRIPTION

(52) **U.S. Cl.** **D6/518**

This application relates to the following design applications being filed concurrently herewith:

(58) **Field of Classification Search** D6/515–523;
206/225, 233, 389, 391; 211/13.1, 45; 242/570,
242/590; 248/309.1, 309.2, 905; 221/26,
221/33, 282–283; 222/173, 180

U.S. Application Ser. No. 29/350,305 entitled Tissue Dispenser

See application file for complete search history.

U.S. Application Ser. No. 29/350309 entitled Tissue Dispenser

(56) **References Cited**

U.S. Application Ser. No. 29/350314 entitled Soap Dispenser

U.S. PATENT DOCUMENTS

U.S. Application Ser. No. 29/350312 entitled Air Freshener Dispenser

D201,298 S	6/1965	Bahnsen	
D246,338 S	11/1977	Jespersen	
D266,039 S	9/1982	DeLuca	
D286,235 S	10/1986	Collins	
D286,236 S	10/1986	Collins	
D293,402 S	12/1987	Petterson	
D312,179 S	11/1990	DeLuca et al.	
D312,180 S	11/1990	Perrin et al.	
D312,184 S	11/1990	De Luca et al.	
D312,369 S	11/1990	De Luca et al.	
D314,045 S	1/1991	De Luca et al.	
D332,023 S	12/1992	Campbell	
D363,628 S	10/1995	McCanless	
D365,713 S *	1/1996	Chen D6/522
D373,276 S	9/1996	Omdoll et al.	
D384,531 S	10/1997	Mervar et al.	
D385,139 S	10/1997	Mervar et al.	
D385,734 S	11/1997	Mervar et al.	
D386,025 S	11/1997	Mervar et al.	
D417,109 S	11/1999	Johnson et al.	
D418,703 S	1/2000	Fitzsimmons	

The disclosures of the foregoing applications are hereby incorporated into this application in their entirety by reference thereto.

FIG. 1 is a top, front, and right side perspective view of a towel dispenser showing my new design;

FIG. 2 is a right side elevation view thereof;

FIG. 3 is a left side elevation view thereof;

FIG. 4 is a front elevation view thereof;

FIG. 5 is a top plan view thereof;

FIG. 6 is a bottom plan view thereof; and,

FIG. 7 is a rear elevation view thereof.

The broken line disclosure is understood to represent portions of the article in which the claimed design is embodied, but which form no part of the claimed design.

1 Claim, 6 Drawing Sheets

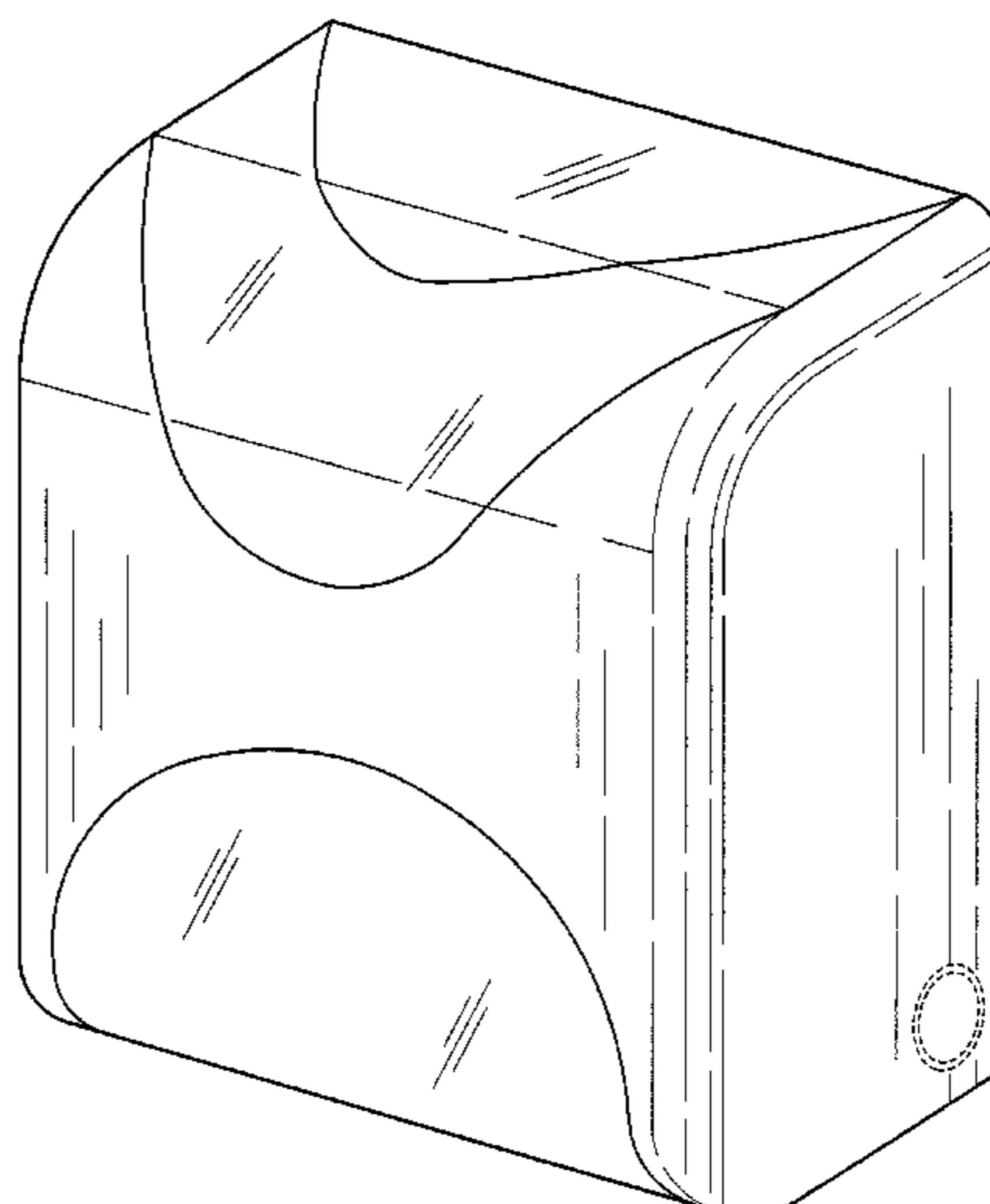

US D619,836 S

Page 2

U.S. PATENT DOCUMENTS

D447,658 S *	9/2001	Fisscher	D6/518	D551,474 S	9/2007	Cittadino et al.	
D447,897 S	9/2001	Fisscher			D551,475 S	9/2007	Cittadino et al.	
D447,898 S	9/2001	Fisscher			D551,476 S	9/2007	Cittadino et al.	
D448,222 S *	9/2001	Fisscher	D6/518	D556,482 S	12/2007	Goeking et al.	
D448,223 S	9/2001	Fisscher			D557,959 S	12/2007	Pommier et al.	
D449,475 S *	10/2001	Ehrensperger	D6/522	D560,939 S *	2/2008	Valot D6/522
D463,929 S	10/2002	Fitzsimmons et al.			D564,267 S *	3/2008	Tomic et al. D6/518
D488,654 S *	4/2004	Omdoll et al.	D6/518	D568,655 S *	5/2008	Friesen et al. D6/518
D522,781 S *	6/2006	Wieser et al.	D6/518	D569,151 S	5/2008	Cittadino et al.	
D525,465 S *	7/2006	Omdoll et al.	D6/518	D572,058 S	7/2008	Cittadino et al.	
D543,402 S	5/2007	Goeking et al.			D578,021 S	10/2008	Reinsel et al.	
D543,745 S	6/2007	Goeking et al.			D579,250 S	10/2008	Cittadino et al.	
D547,581 S	7/2007	Cittadino et al.			D581,709 S *	12/2008	Erekson D6/518
D550,999 S *	9/2007	Formon et al.	D6/518	D583,174 S	12/2008	Kuehneman et al.	
					D605,444 S	12/2009	Marietta-Tondin	

* cited by examiner

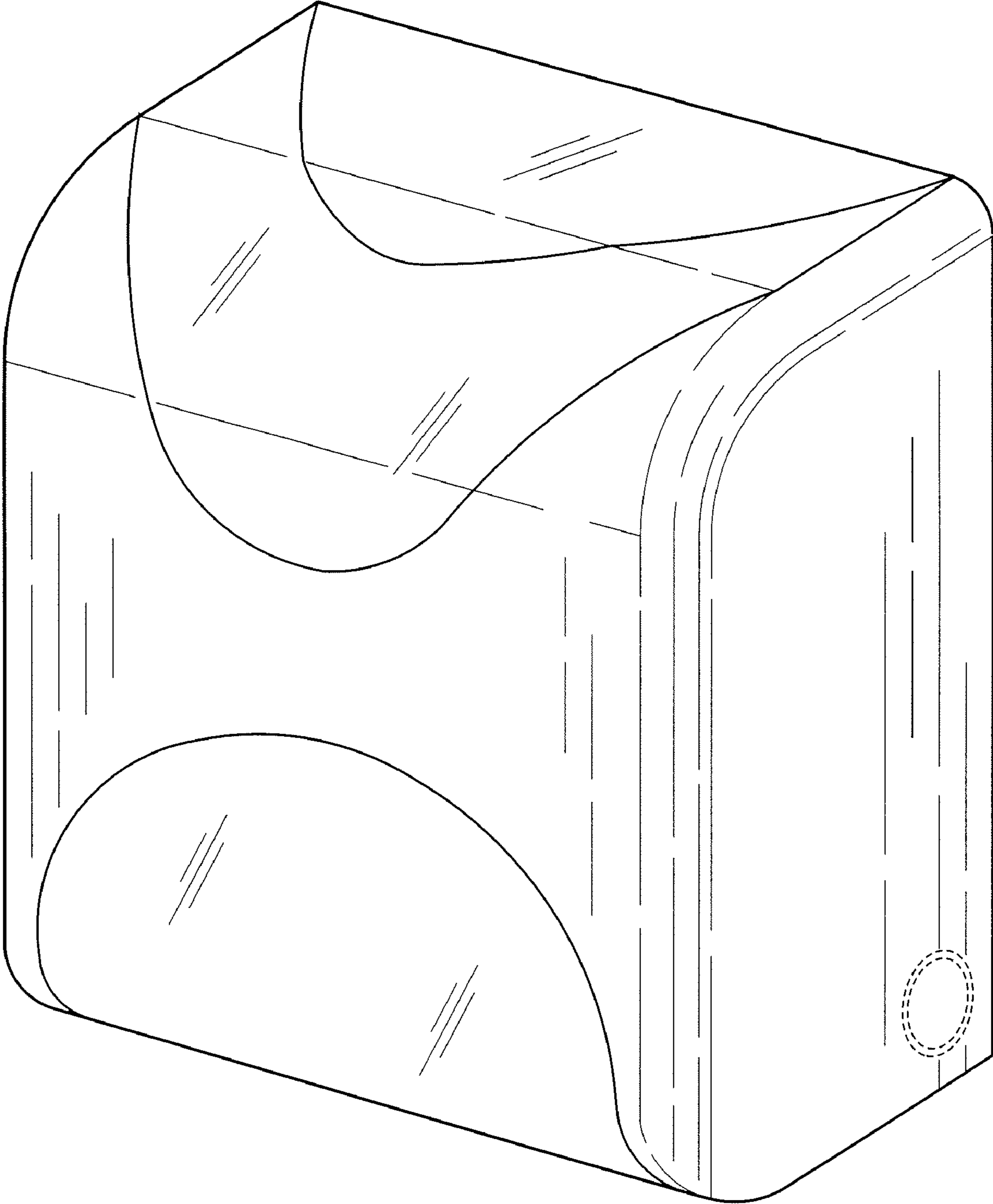

Fig. 1

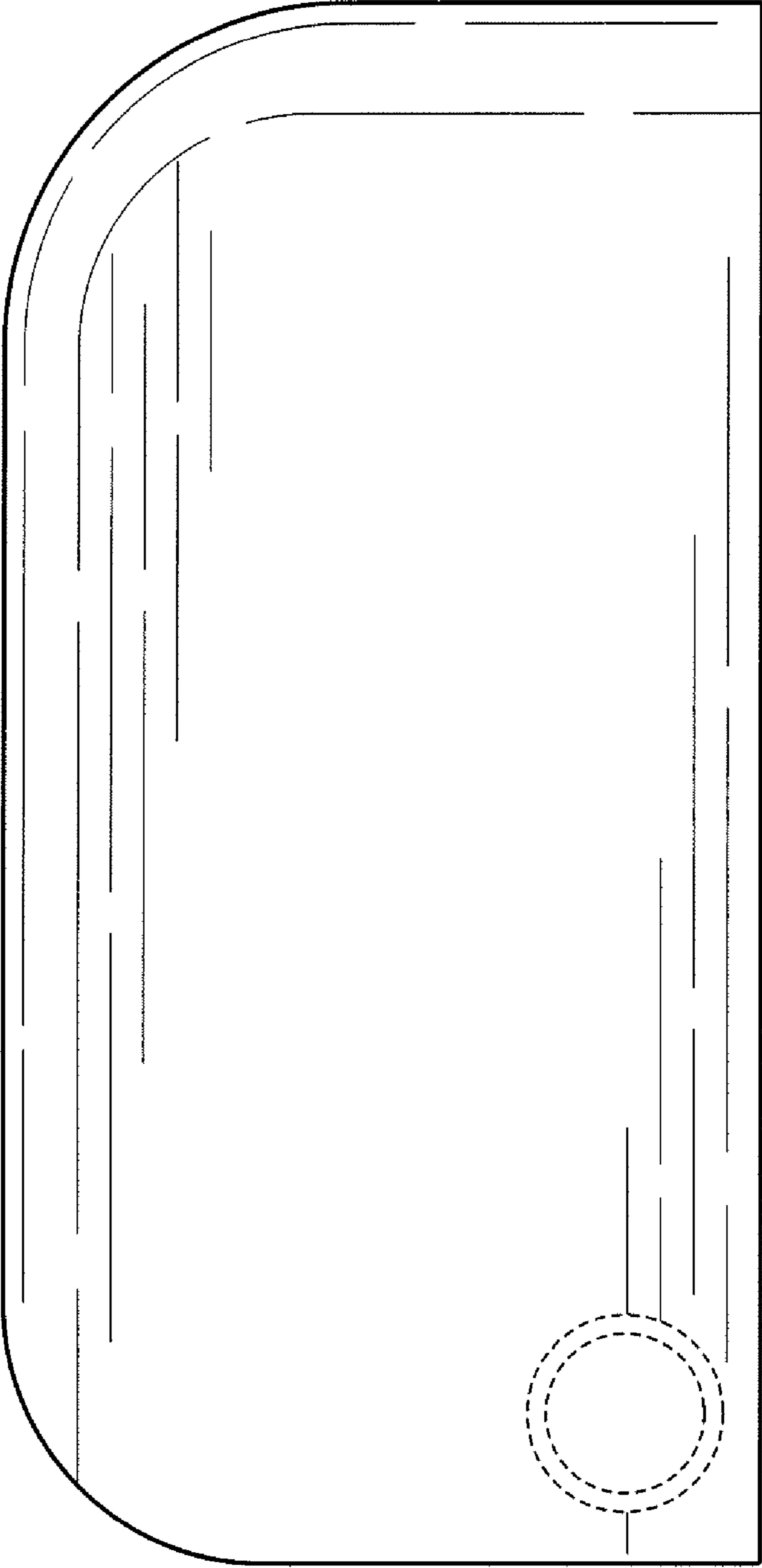

Fig. 2

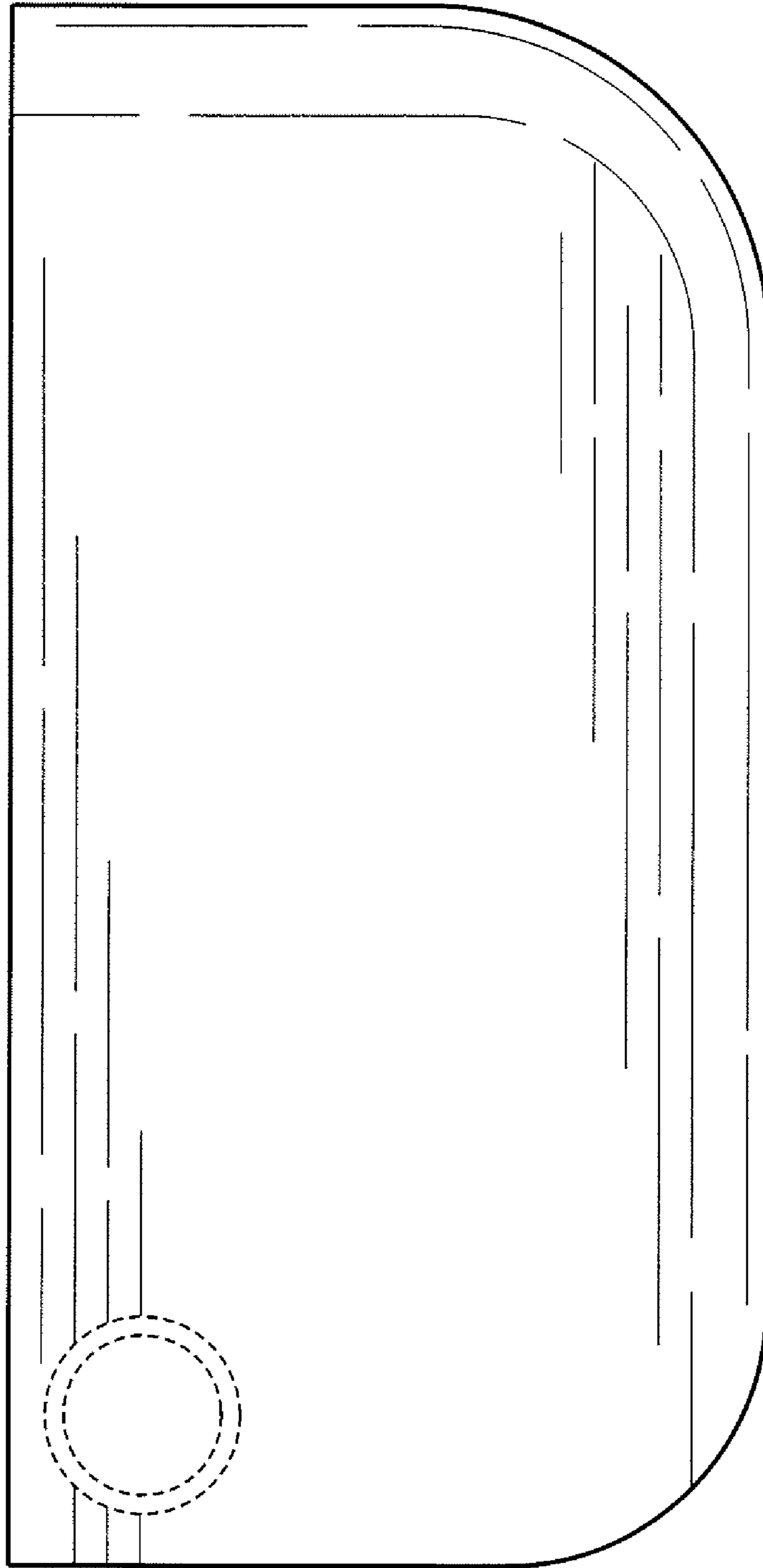

Fig. 3

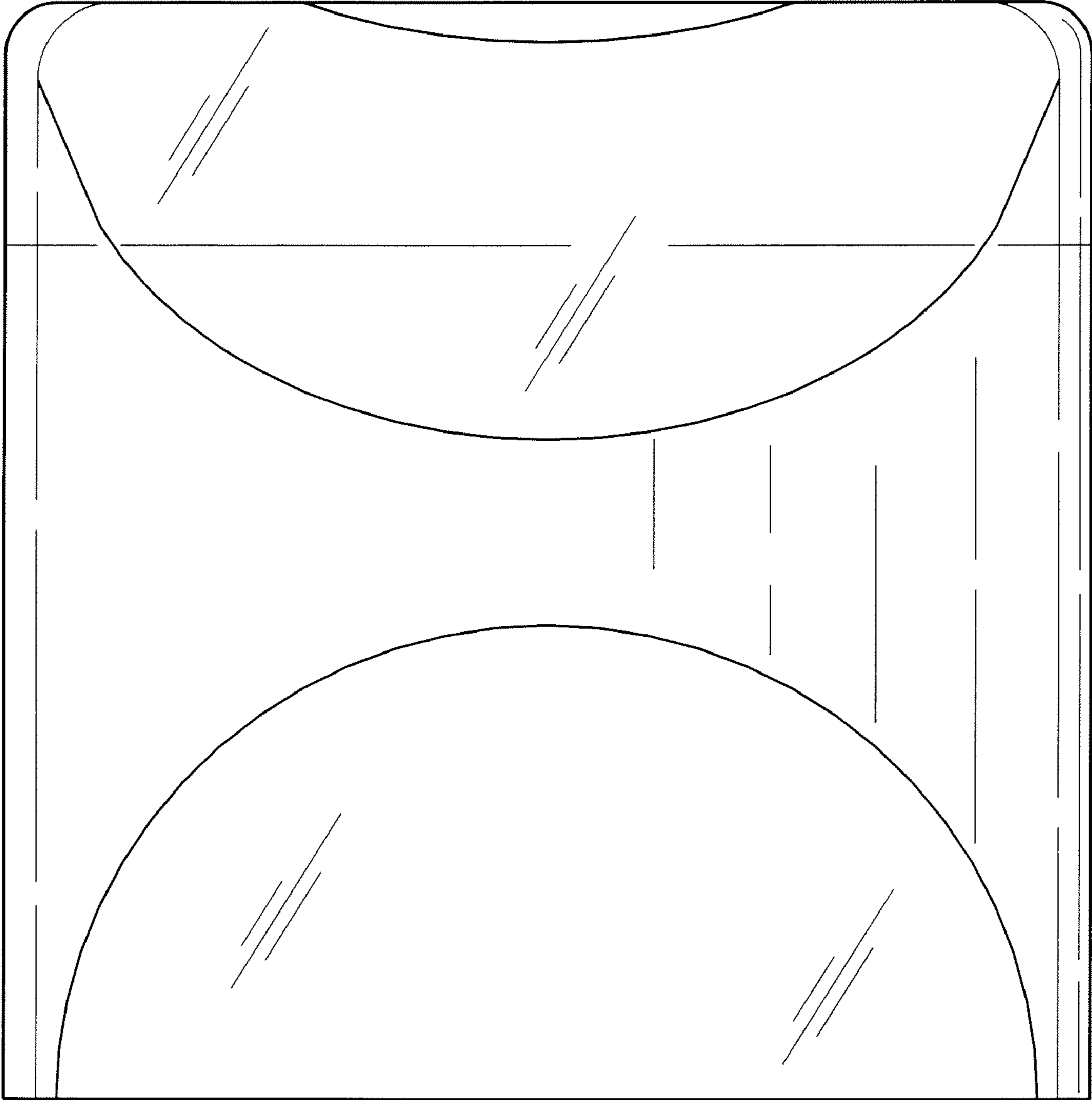

Fig. 4

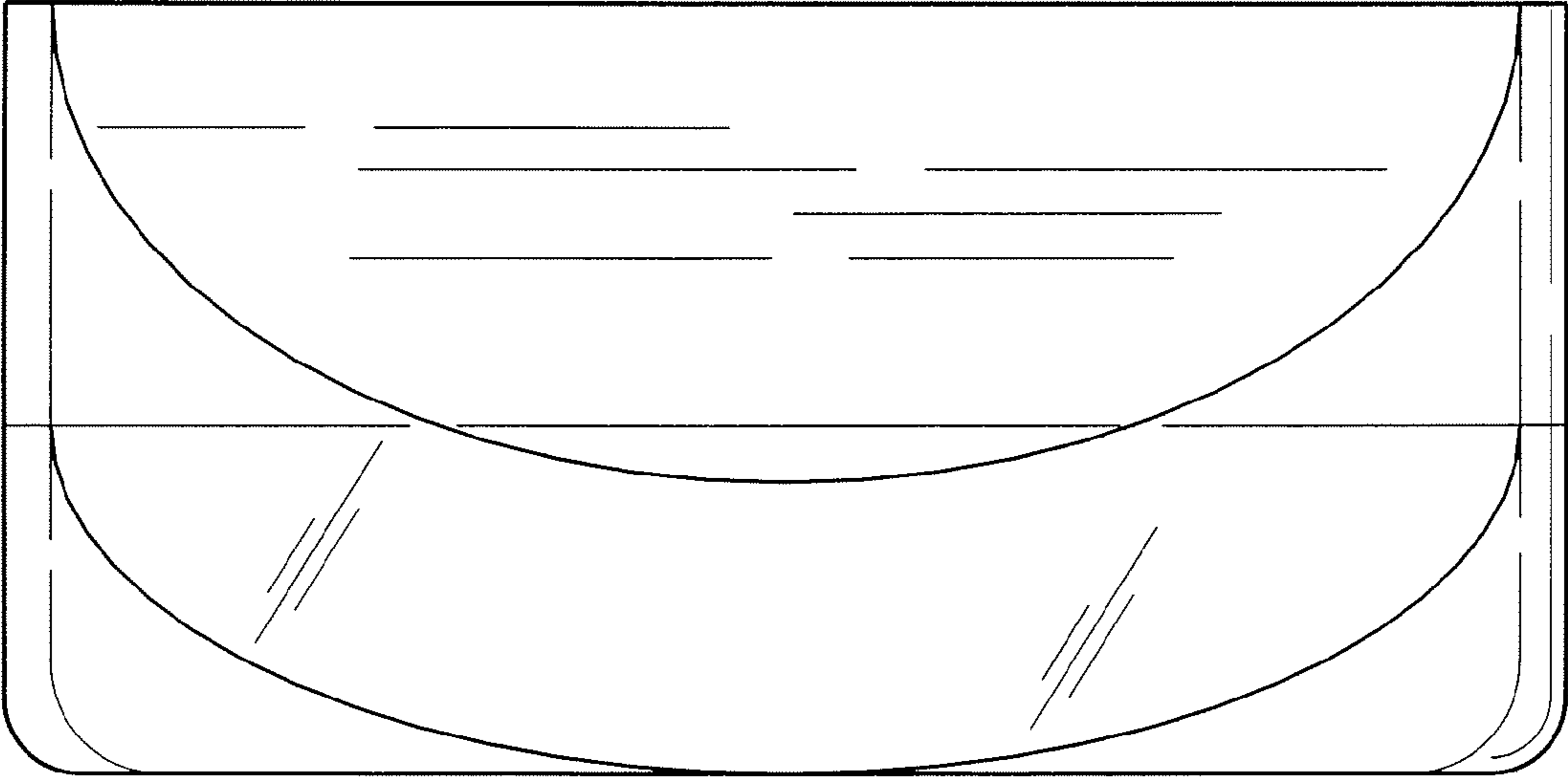

Fig. 5

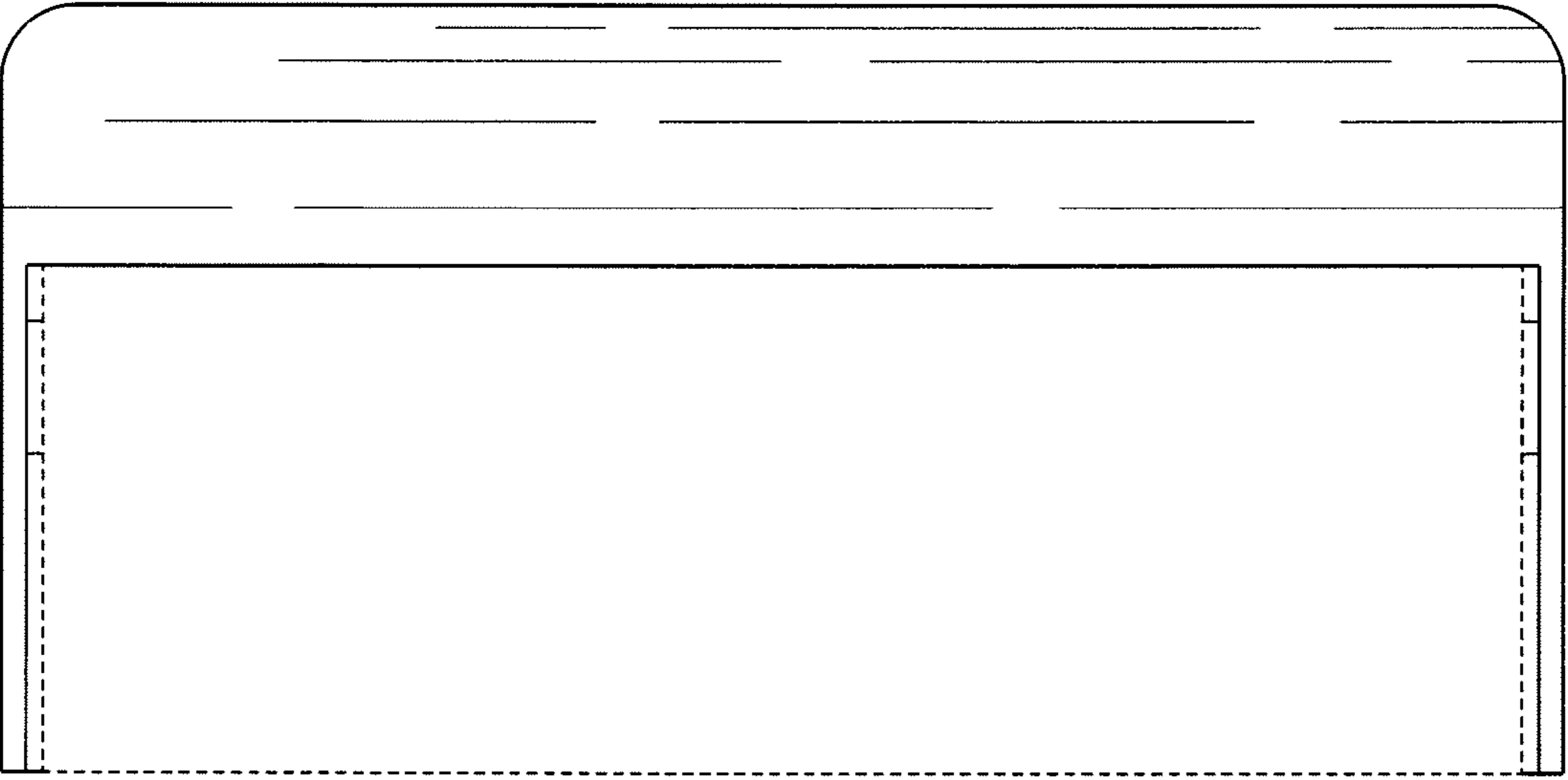

Fig. 6

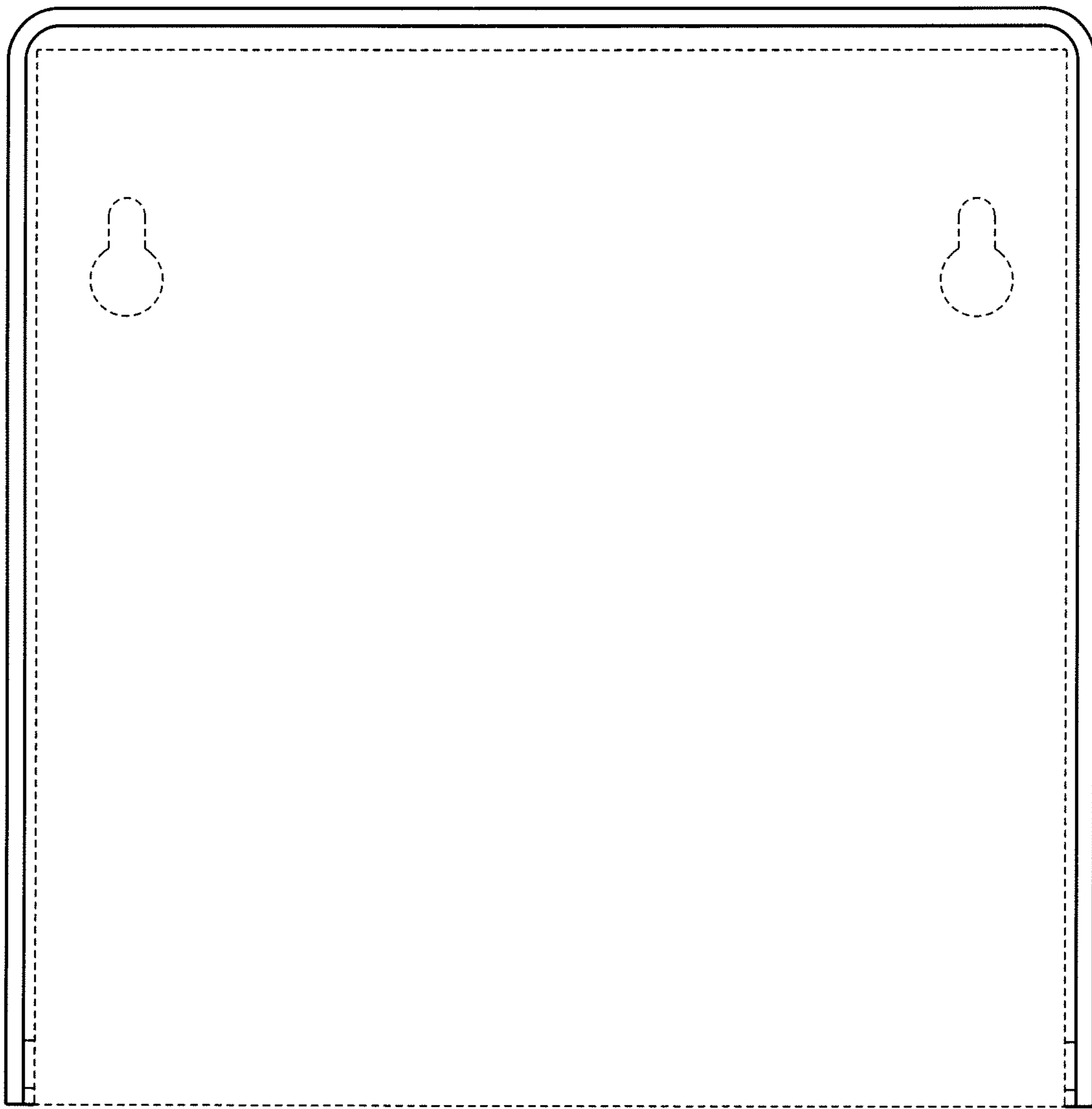

Fig. 7