



US00D619826S

(12) **United States Design Patent**
Calco et al.

(10) **Patent No.:** **US D619,826 S**
(45) **Date of Patent:** **** Jul. 20, 2010**

(54) **TELEVISION STAND**

D598,675 S * 8/2009 Everson D6/480

(75) Inventors: **Wayne Calco**, Laguna Hills, CA (US);
Henner Jahns, Los Angeles, CA (US);
Joseph Klingl, Los Angeles, CA (US)

* cited by examiner

Primary Examiner—Elizabeth A Albert
Assistant Examiner—Kelley A Donnelly

(73) Assignee: **Atlantic Representations, Inc.**, Santa Fe Springs, CA (US)

(74) *Attorney, Agent, or Firm*—Cisco & Thomas, LLP

(**) Term: **14 Years**

(57) **CLAIM**

(21) Appl. No.: **29/351,206**

The ornamental design for a television stand, as shown and described.

(22) Filed: **Dec. 2, 2009**

DESCRIPTION

(51) **LOC (9) Cl.** **06-04**

FIG. 1 is a perspective view of our television stand;

(52) **U.S. Cl.** **D6/477**

FIG. 2 is a front view thereof;

(58) **Field of Classification Search** D6/477,

FIG. 3 is a right side view thereof;

D6/474, 478–479, 480–489, 495, 450–451,

FIG. 4 is a left side view thereof;

D6/436, 460; 108/153.1, 155–156, 161;

FIG. 5 is a rear view thereof;

248/188, 188.1, 188.8; 211/40–42

FIG. 6 is a top view thereof; and

See application file for complete search history.

FIG. 7 is a bottom view thereof;

(56) **References Cited**

FIG. 8 is a perspective view of another embodiment of our television stand

U.S. PATENT DOCUMENTS

FIG. 9 is a front view thereof;

D196,440 S * 10/1963 Turner D6/477

FIG. 10 is a right side view thereof;

3,910,205 A * 10/1975 Gusdorf 108/101

FIG. 11 is a left side view thereof;

D258,177 S * 2/1981 Baker D6/478

FIG. 12 is a rear view thereof

D267,617 S * 1/1983 Hickey D6/484

FIG. 13 is a top view thereof; and,

D273,829 S * 5/1984 Desnoyers D6/484

FIG. 14 is a bottom view thereof.

D284,339 S * 6/1986 Berry, Jr. D6/477

The broken line portions of the disclosure are included for the purpose of illustrating environment and form no part of the claimed design.

D285,267 S * 8/1986 Berry, Jr. D6/430

1 Claim, 12 Drawing Sheets

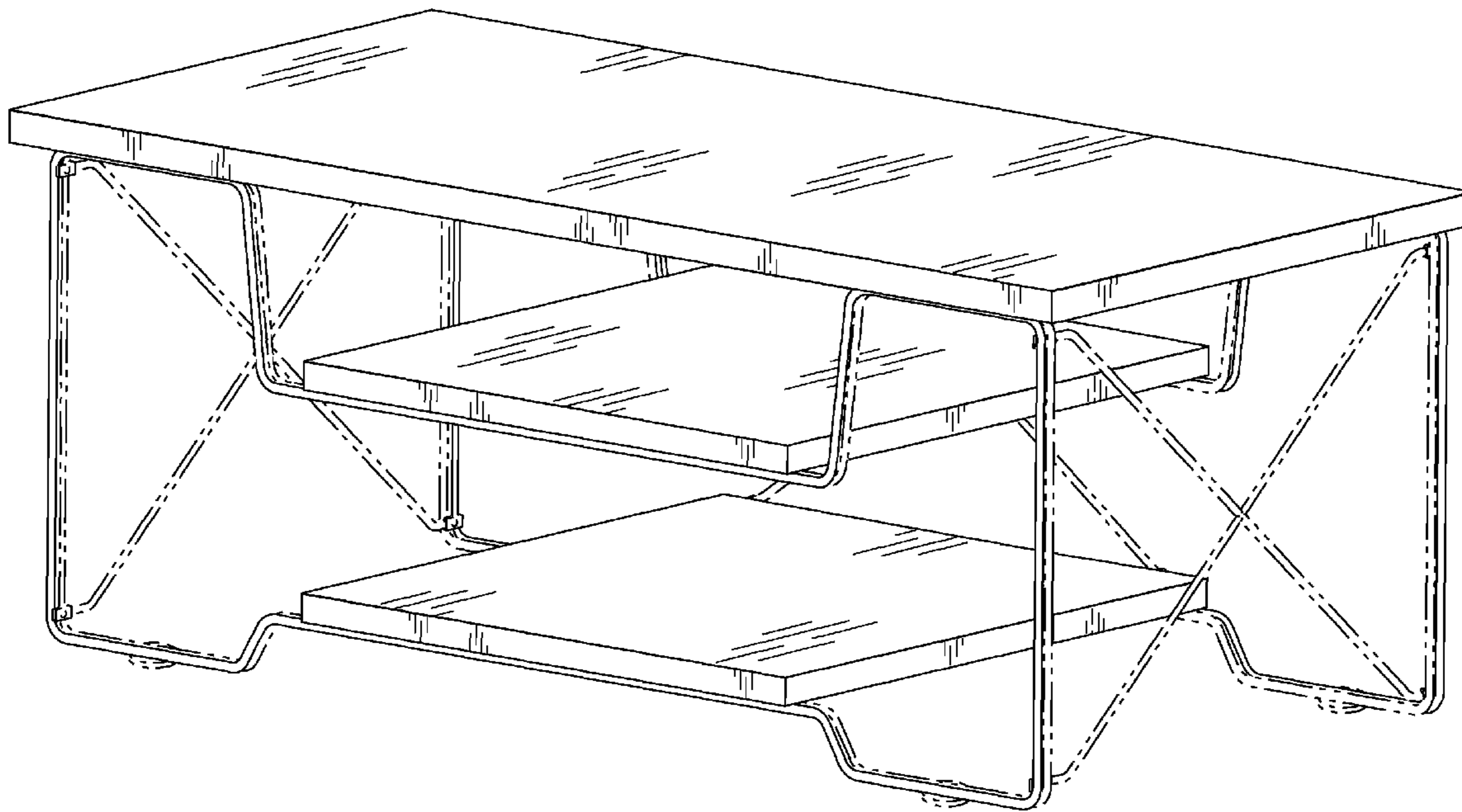

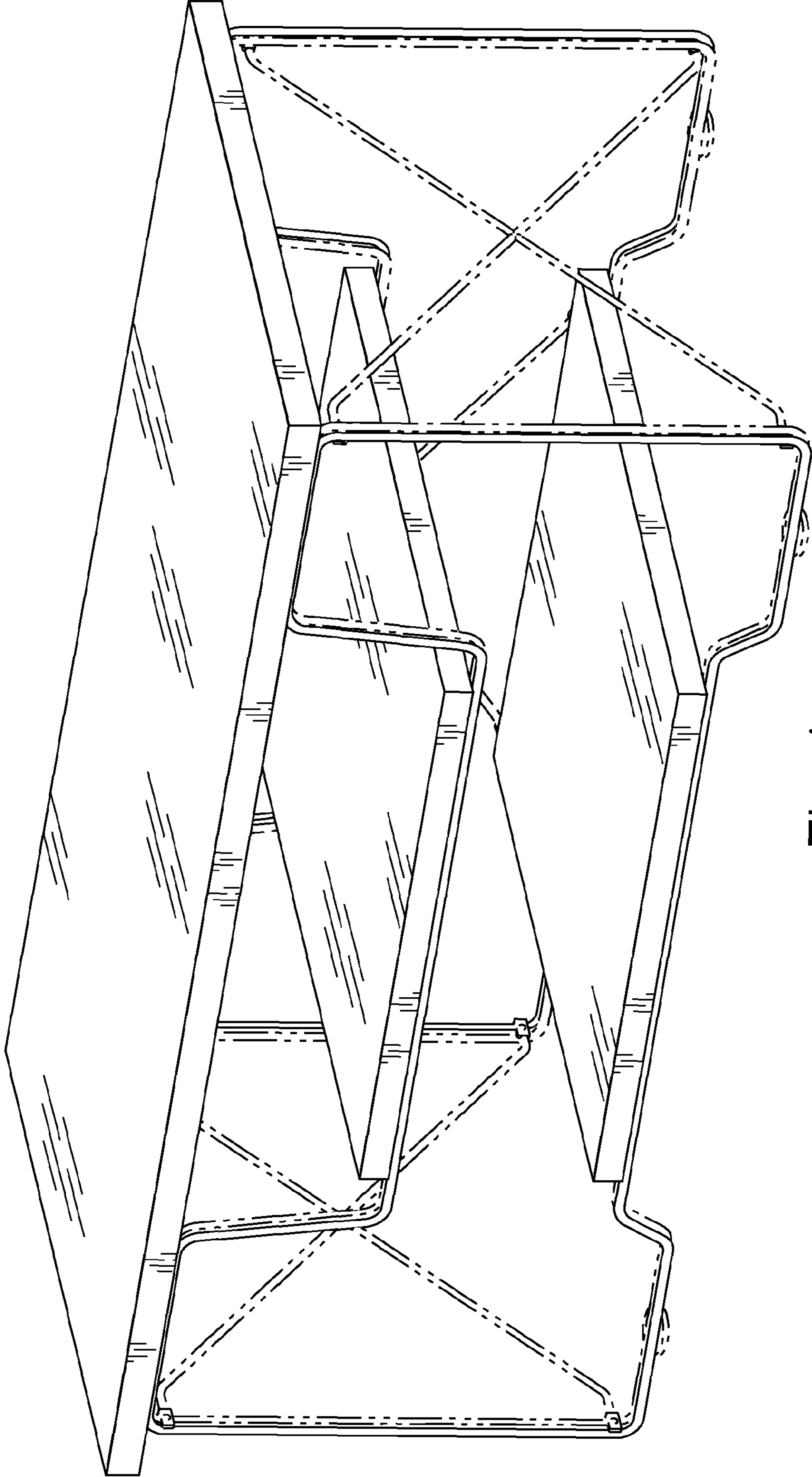

Fig. 1

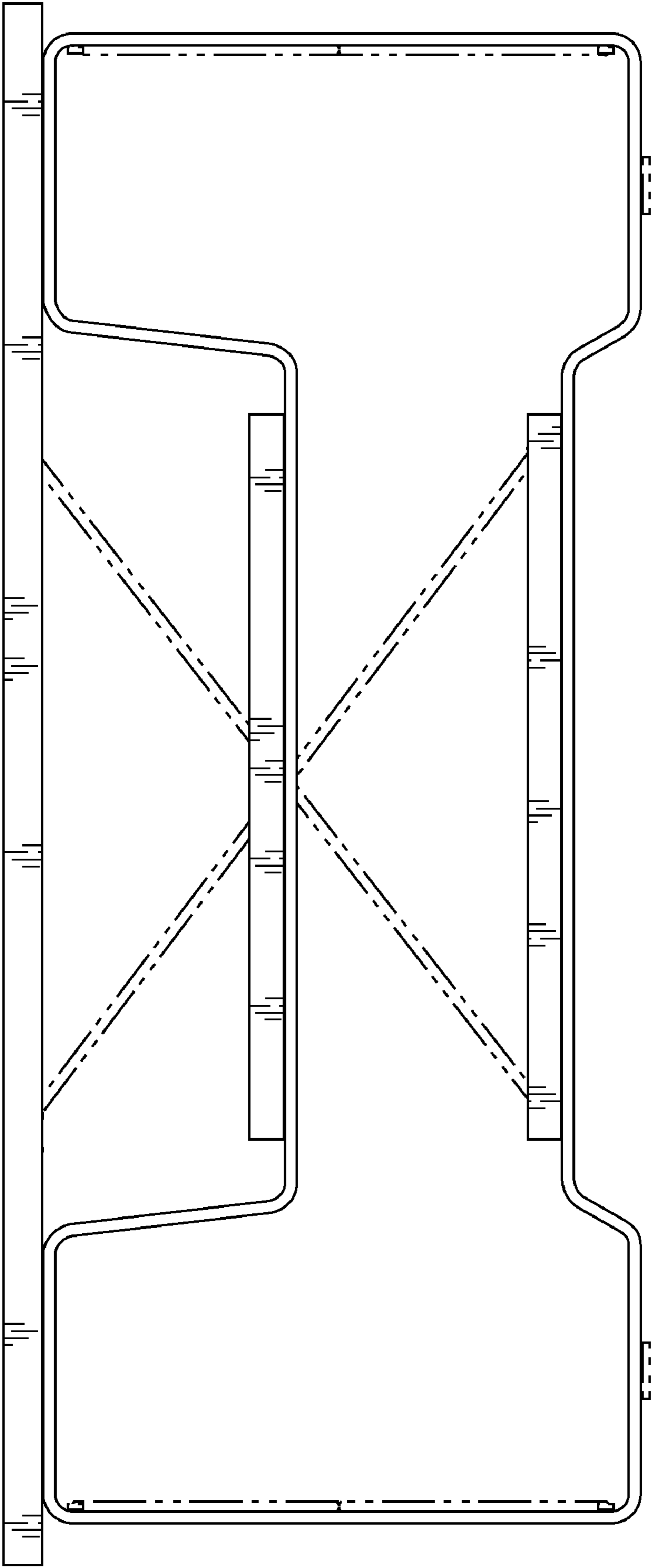

Fig. 2

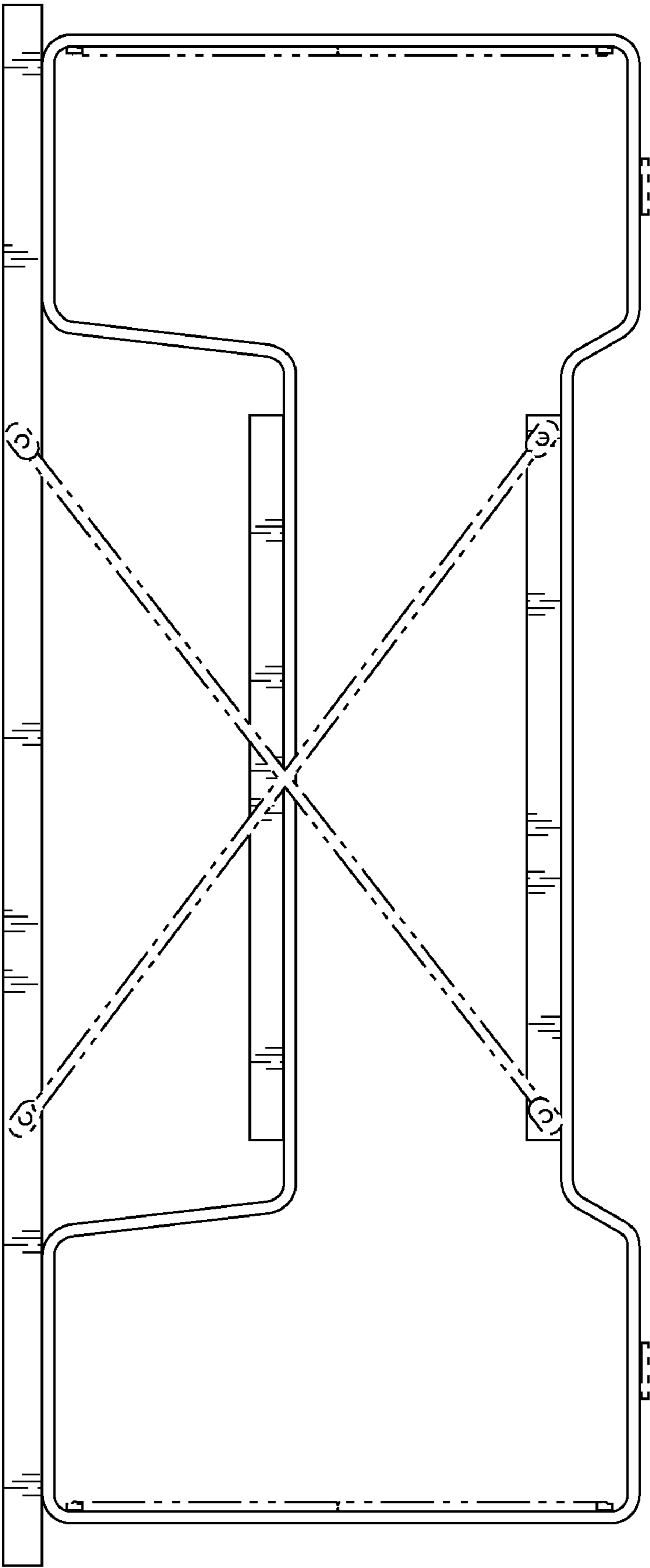

Fig. 3

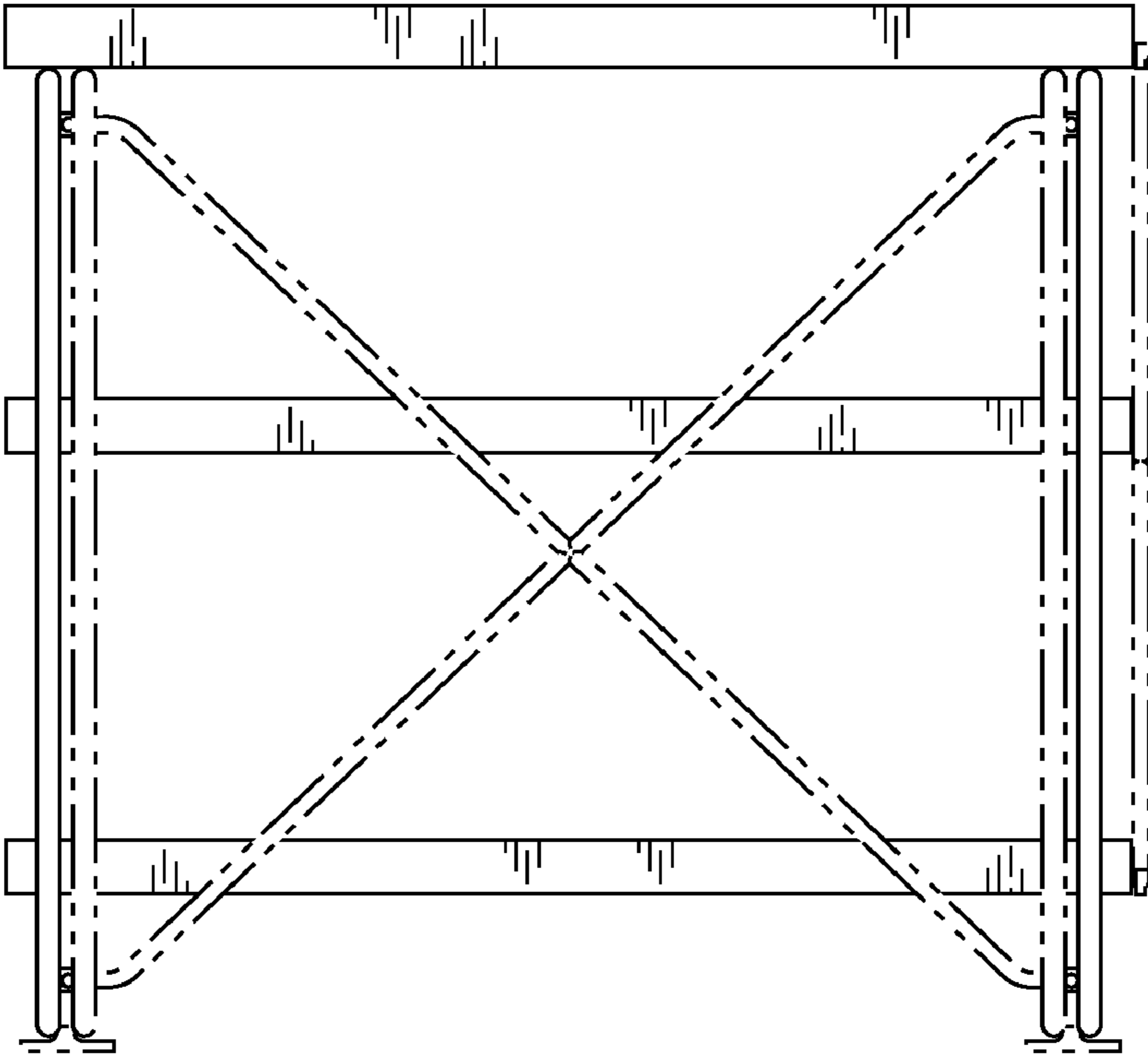

Fig. 4

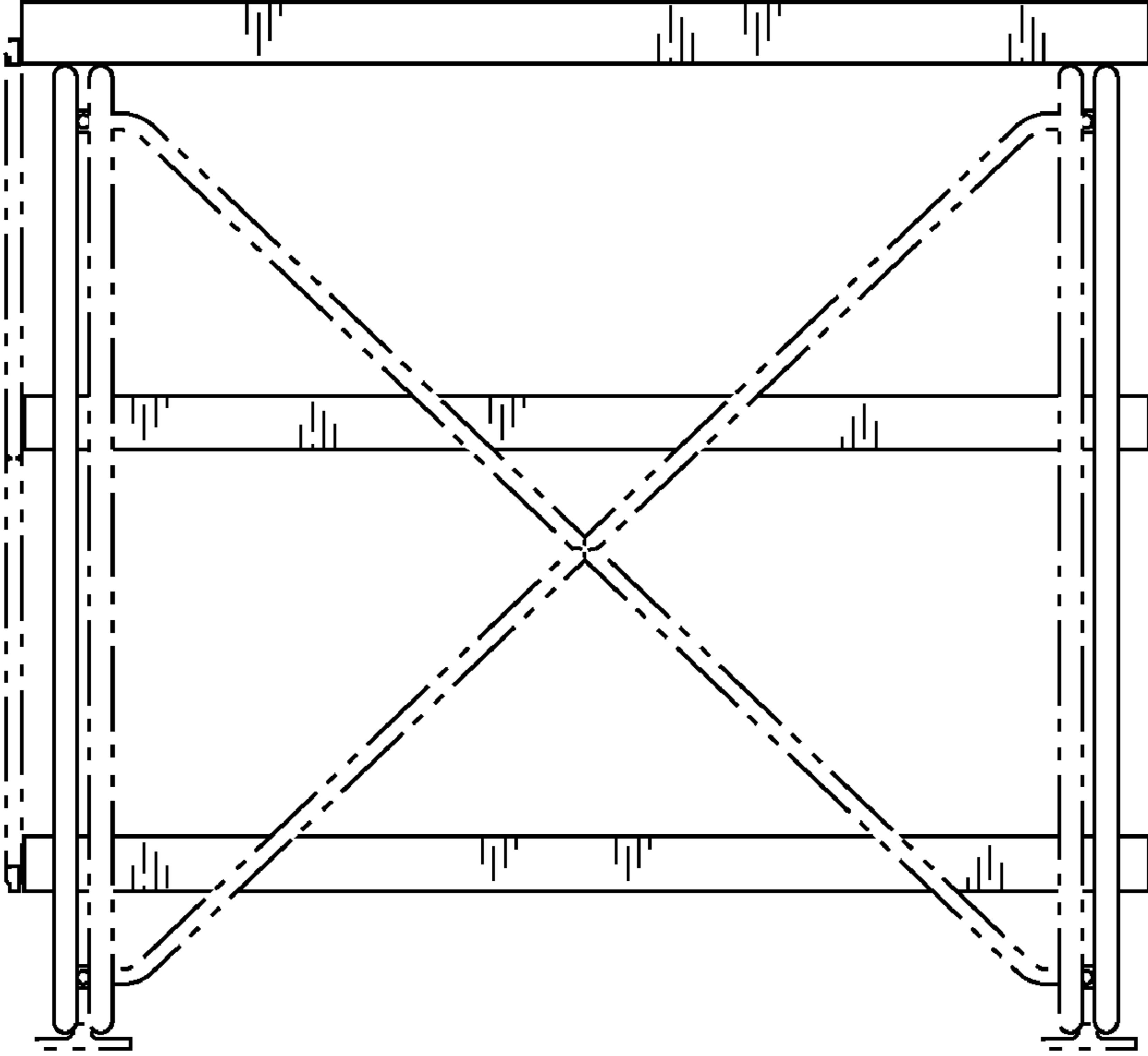

Fig. 5

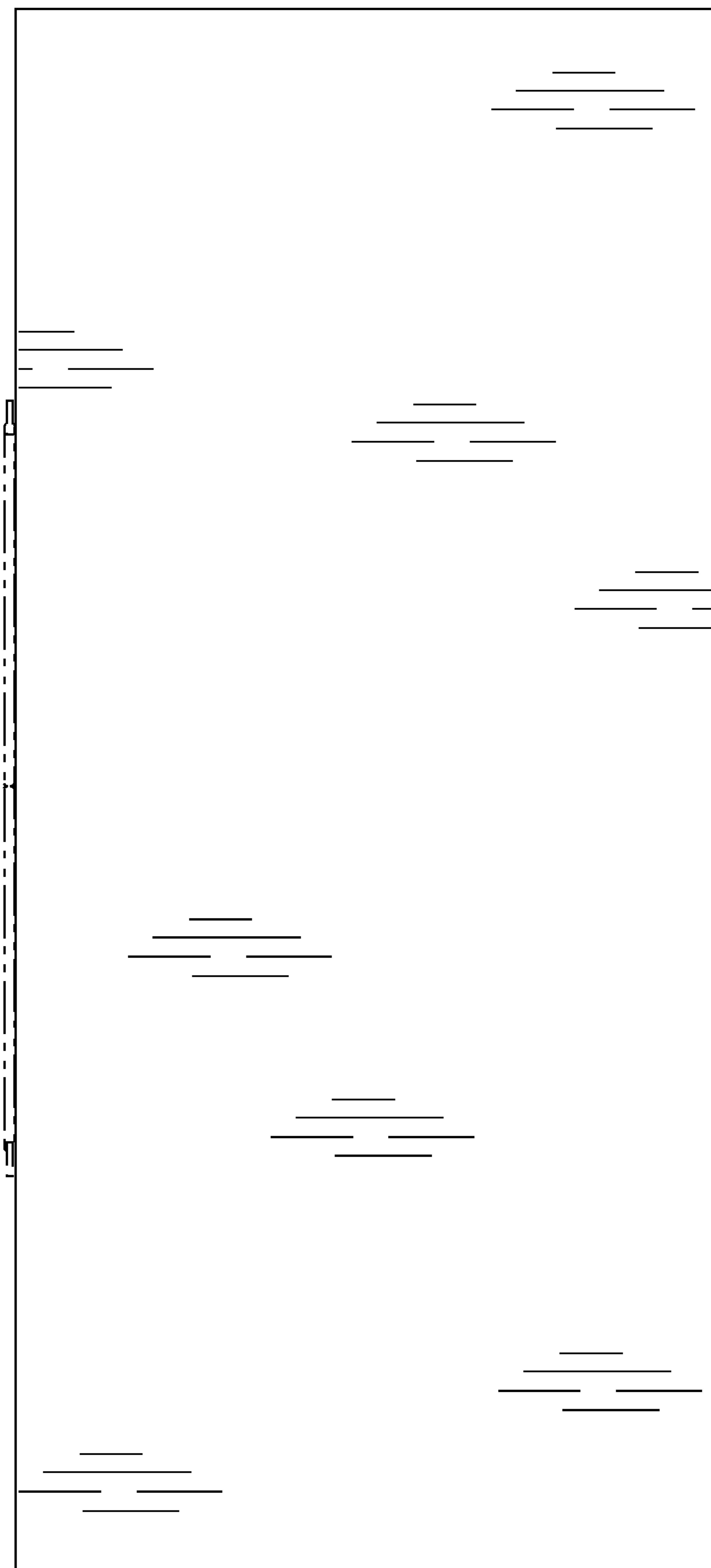

Fig. 6

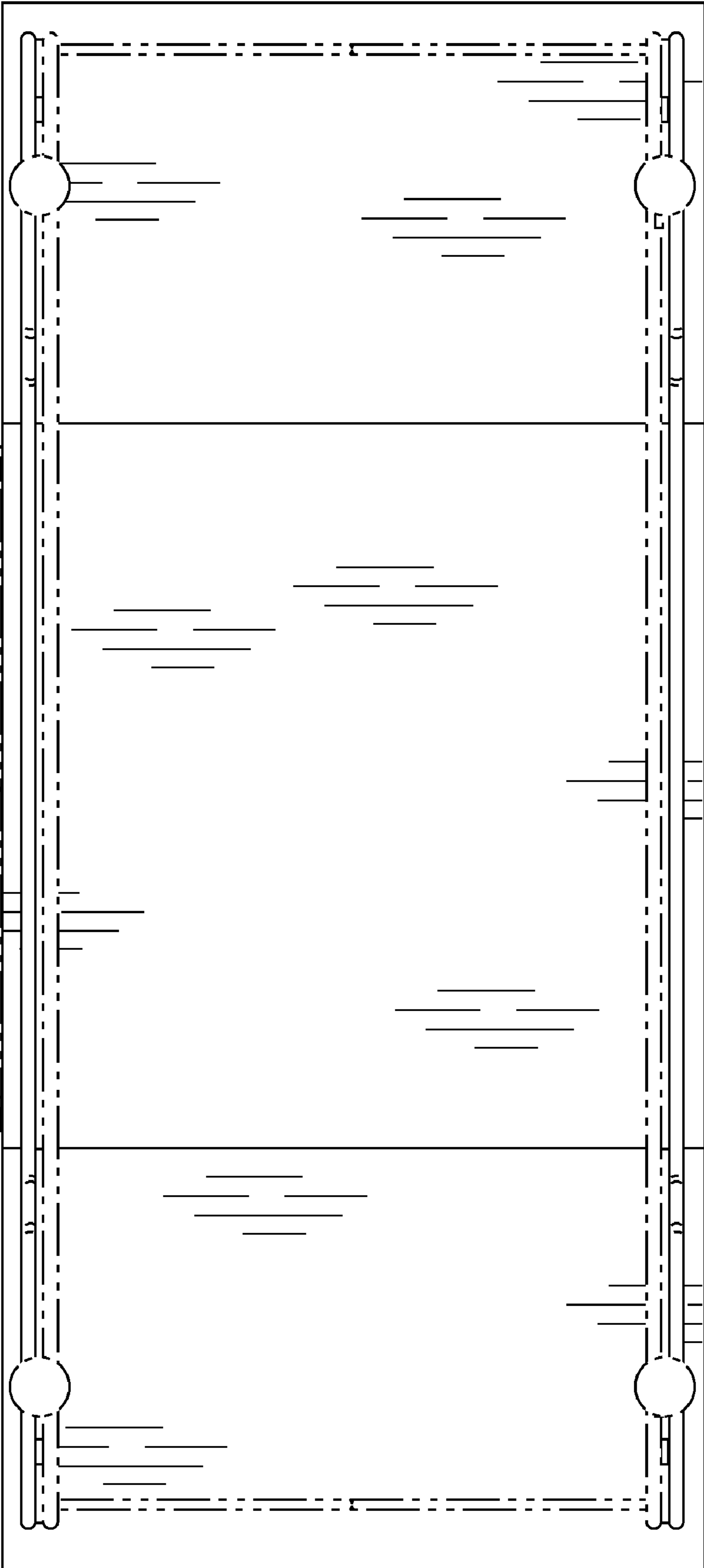

Fig. 7

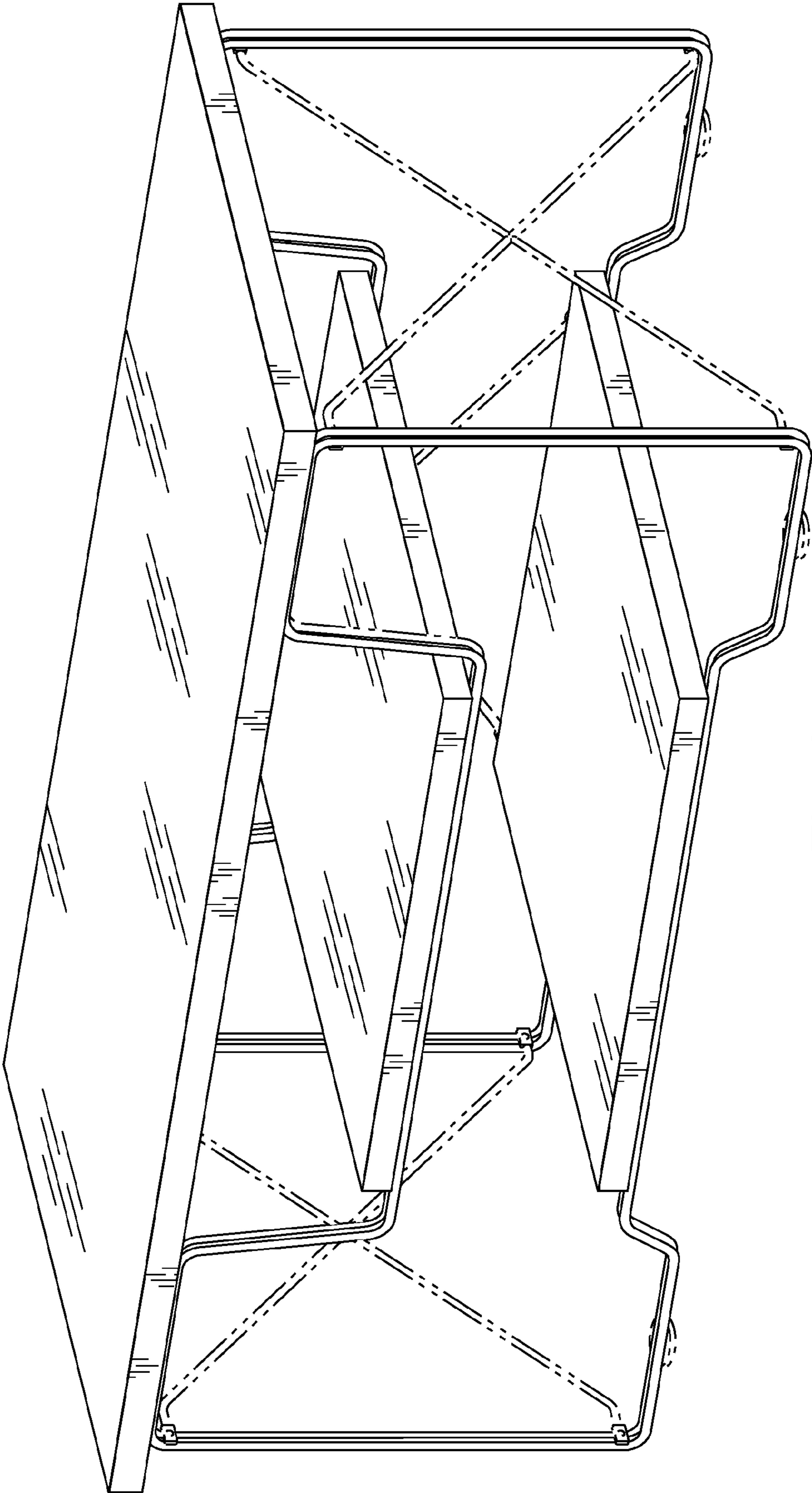

Fig. 8

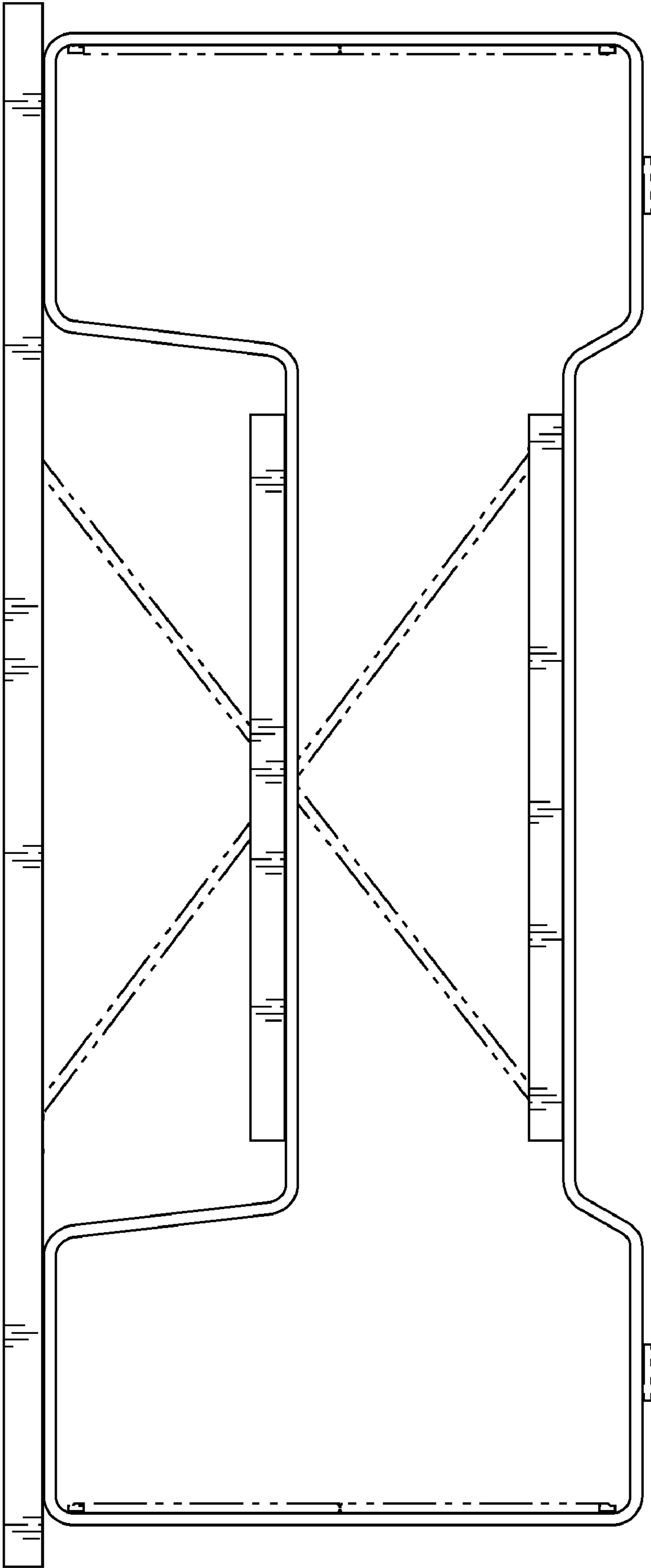

Fig. 9

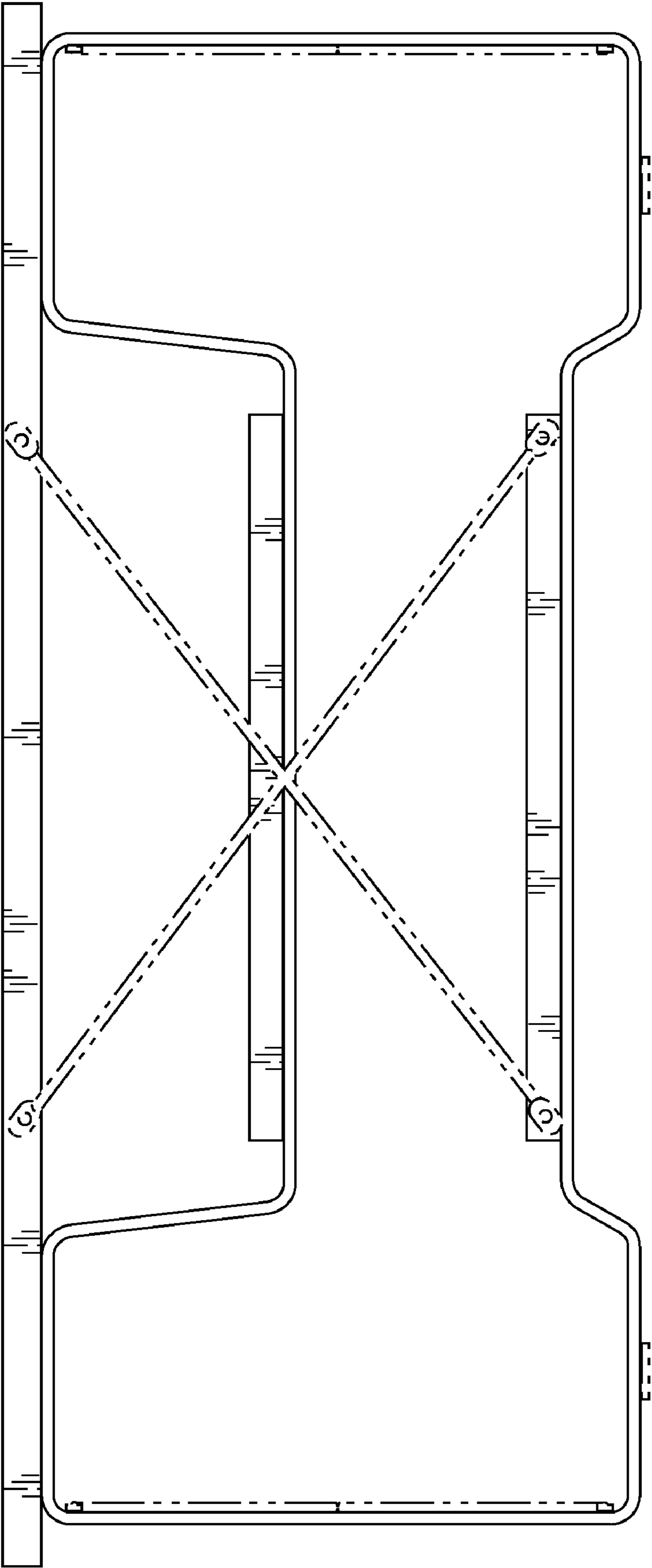

Fig. 10

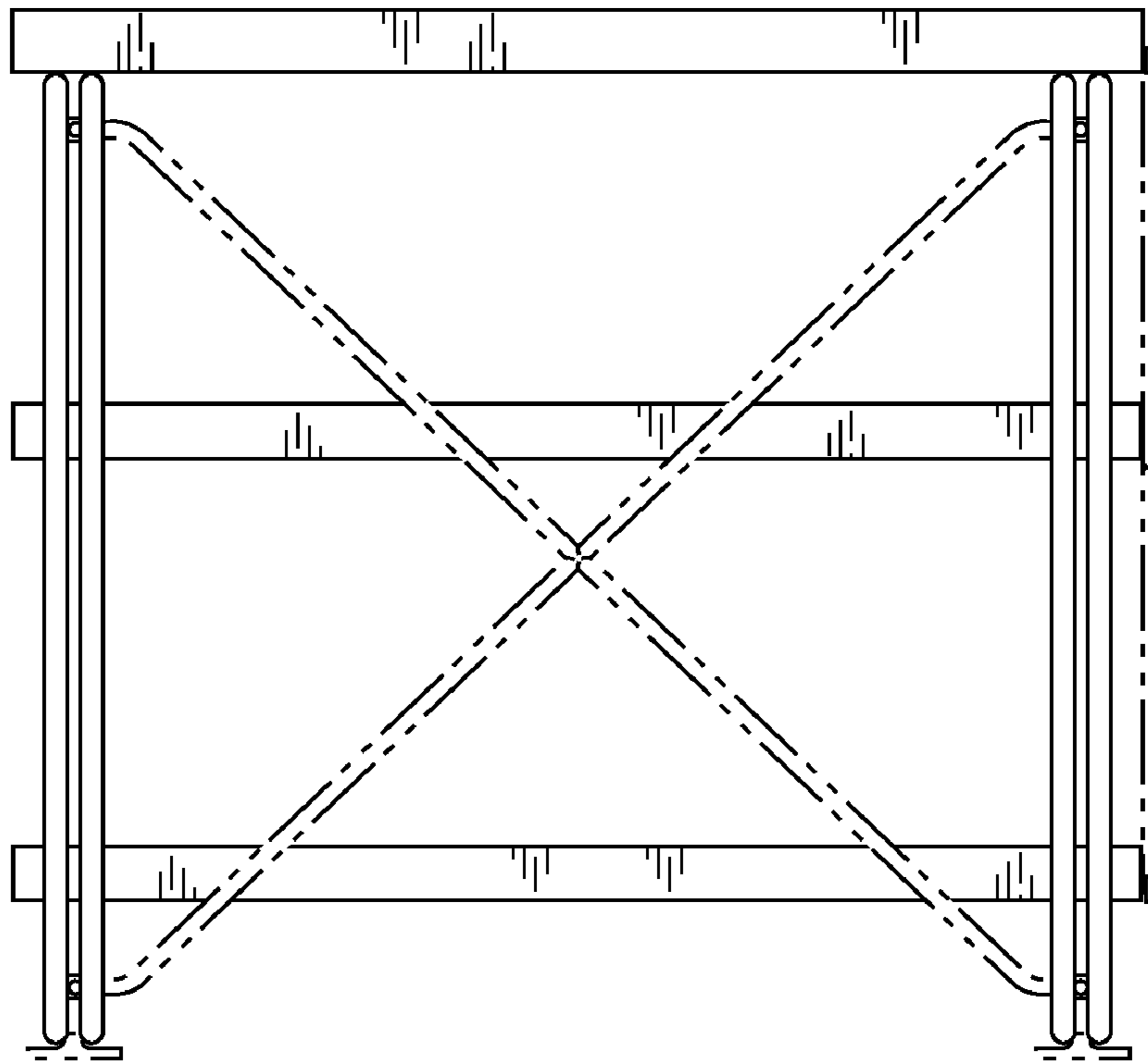

Fig. 11

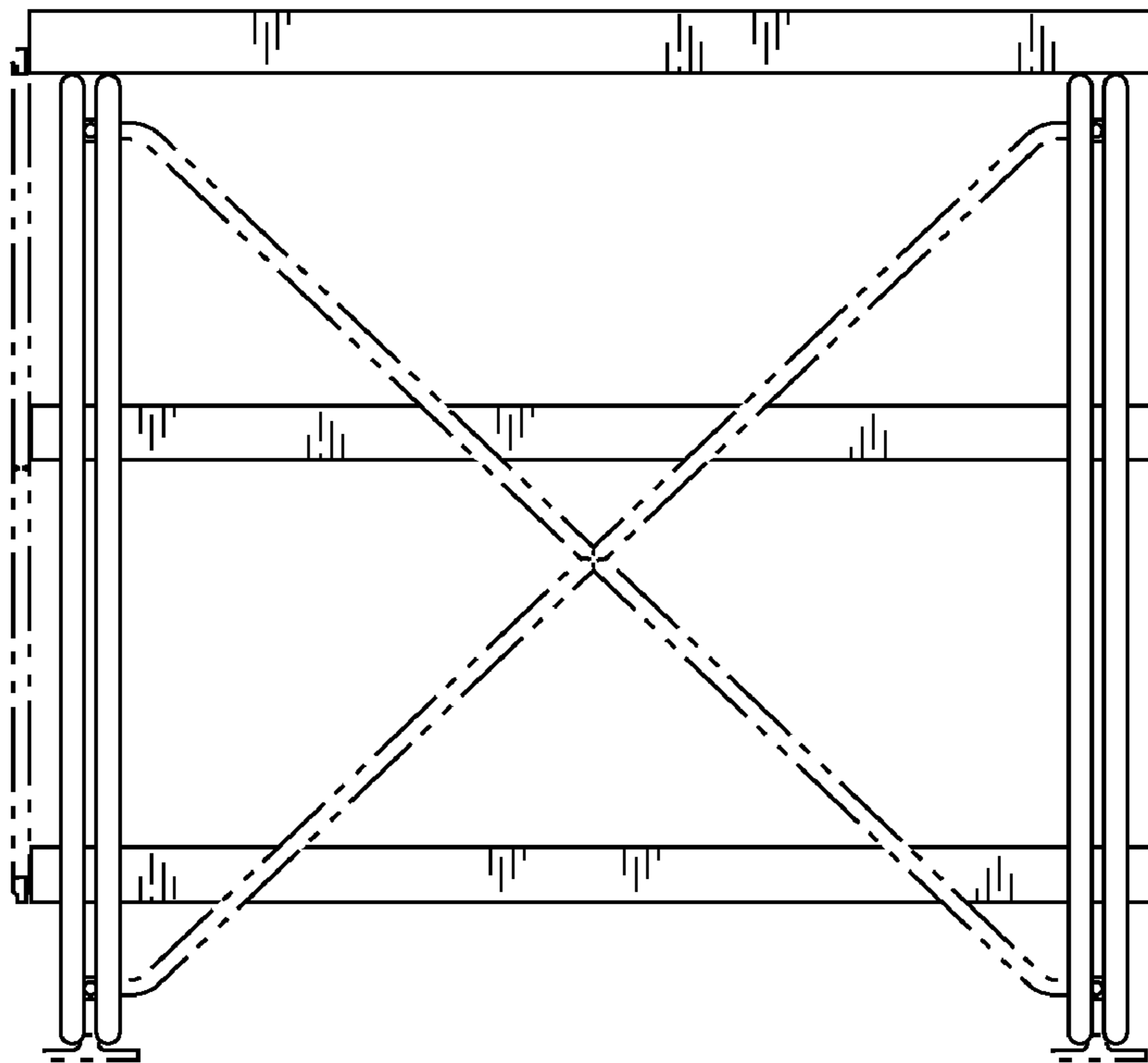

Fig. 12

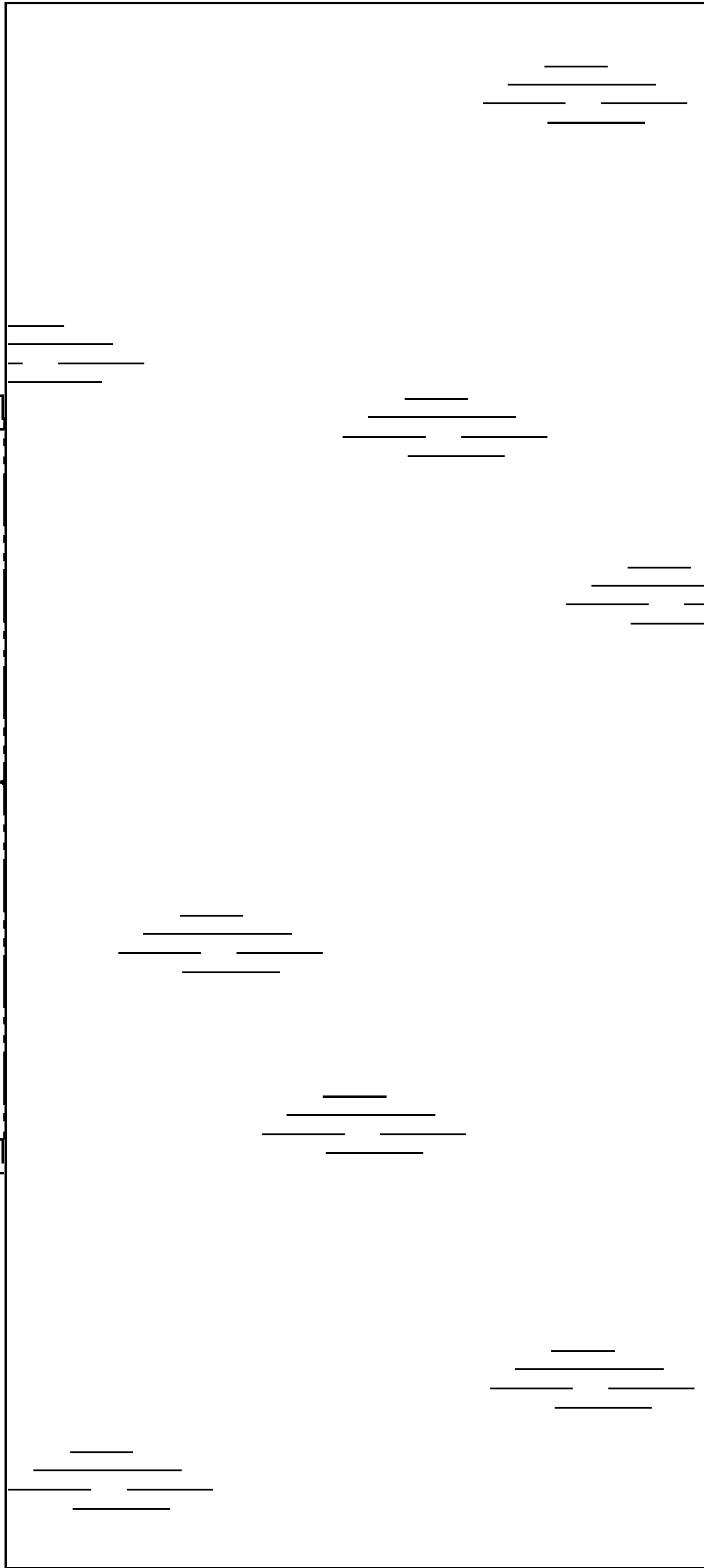

Fig. 13

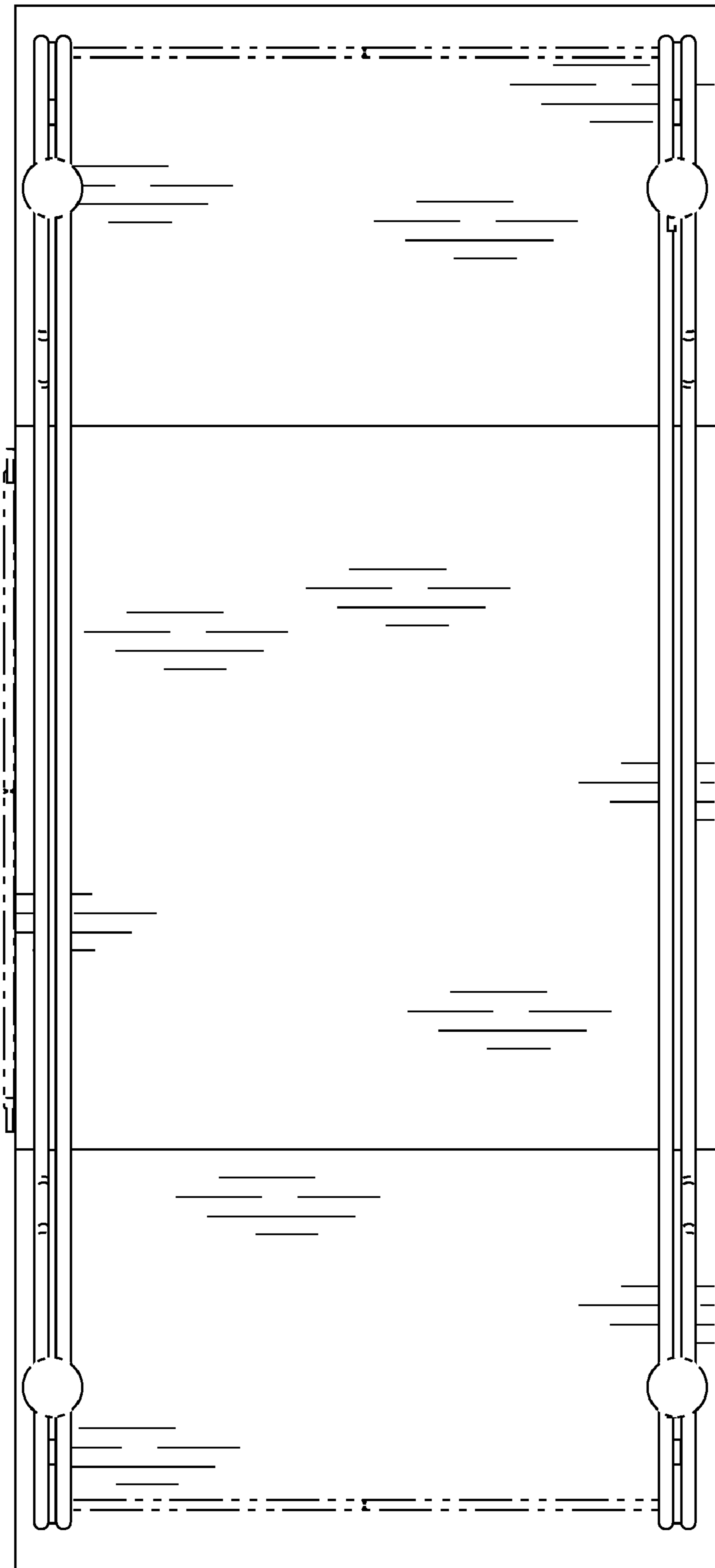

Fig. 14