



US00D619728S

(12) **United States Design Patent**  
**Bare et al.**

(10) **Patent No.:** **US D619,728 S**  
(45) **Date of Patent:** **\*\* Jul. 13, 2010**

(54) **SPIN CUVETTE**

(75) Inventors: **Rex O. Bare**, Lake Forest, CA (US);  
**Ronald K. Bergold**, Mission Viejo, CA (US)

(73) Assignee: **IBIS Biosciences, Inc.**, Carlsbad, CA (US)

(\*\*) Term: **14 Years**

(21) Appl. No.: **29/330,904**

(22) Filed: **Jan. 15, 2009**

(51) **LOC (9) Cl.** ..... **24-01**

(52) **U.S. Cl.** ..... **D24/224; D8/83**

(58) **Field of Classification Search** ..... D24/133,  
D24/144, 146-147, 108, 121, 216, 224, 223,  
D24/117; D8/29, 80, 83, 107; D9/516, 530,  
D9/549, 520; 81/177.1, 436, 437, 489; 606/160;  
422/99, 102, 104, 58, 61, 64, 100; 435/288.1,  
435/294.1, 295.1, 297.1, 298.1, 298.2, 299.2

See application file for complete search history.

(56) **References Cited**

**U.S. PATENT DOCUMENTS**

1,325,070	A *	12/1919	Andrews	.....	D8/83
1,532,822	A *	4/1925	Kemp	.....	D8/80
3,893,887	A *	7/1975	Smith et al.	.....	435/298.2
D257,394	S *	10/1980	Reichler	.....	D9/696
D278,653	S *	4/1985	Savitz et al.	.....	D24/224
D330,428	S *	10/1992	Lewis et al.	.....	D24/224
D362,390	S *	9/1995	Weiler	.....	D24/224
D380,555	S *	7/1997	Kurosaki et al.	.....	D24/224
D403,079	S *	12/1998	Pawlak et al.	.....	D24/224
D418,733	S *	1/2000	Lynn et al.	.....	D8/107

D449,506	S *	10/2001	Haung	.....	D8/83
D525,839	S *	8/2006	Rauckman	.....	D8/29
D561,293	S *	2/2008	Mott	.....	D22/108
D567,604	S *	4/2008	Yu	.....	D8/29
D583,481	S *	12/2008	Yamamoto et al.	.....	D24/224
D584,933	S *	1/2009	Jergenson et al.	.....	D8/29
D591,438	S *	4/2009	Hama et al.	.....	D26/37
2006/0057033	A1 *	3/2006	Goldenberg	.....	422/102
2008/0139875	A1 *	6/2008	Tracey et al.	.....	600/29

\* cited by examiner

*Primary Examiner*—Ian Simmons  
*Assistant Examiner*—Wan Laymon

(74) *Attorney, Agent, or Firm*—Casimir Jones S.C.

(57) **CLAIM**

The ornamental design for a spin cuvette, as shown and described.

**DESCRIPTION**

FIG. 1 is a top perspective view of a spin cuvette showing our new design;

FIG. 2 is a top plan view thereof, the bottom plan view being identical thereof;

FIG. 3 is a left side elevational view thereof, the right side elevational view being mirror image thereof;

FIG. 4 is a front elevational view thereof;

FIG. 5 is a rear elevational view thereof; and,

FIG. 6 is an alternate left side elevational view thereof, shown on a reduced scale.

The broken line depictions in FIG. 6 are for illustrative purposes only and form no part of the claimed design.

**1 Claim, 2 Drawing Sheets**

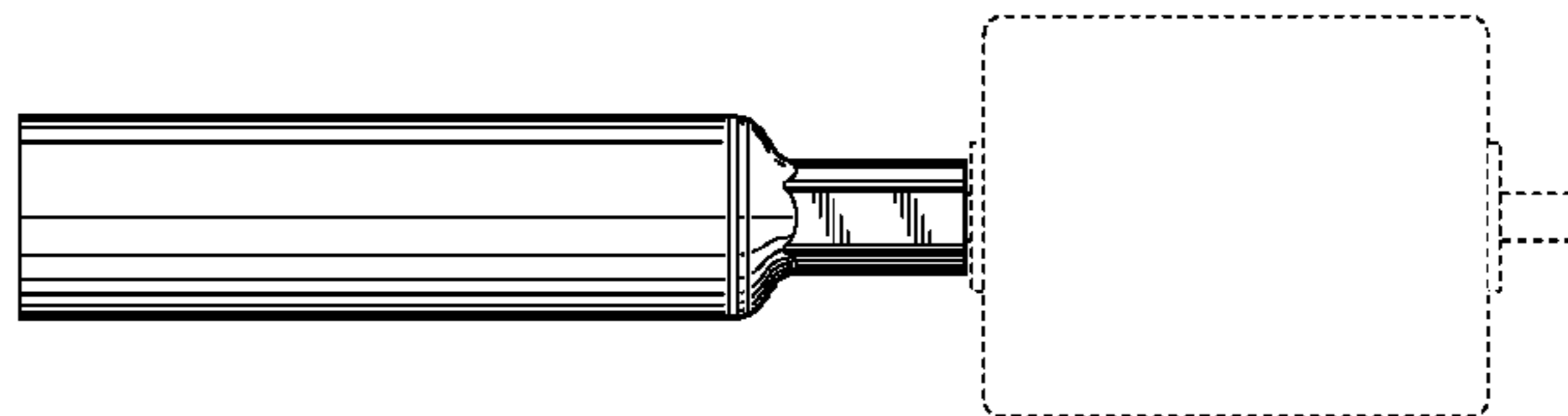
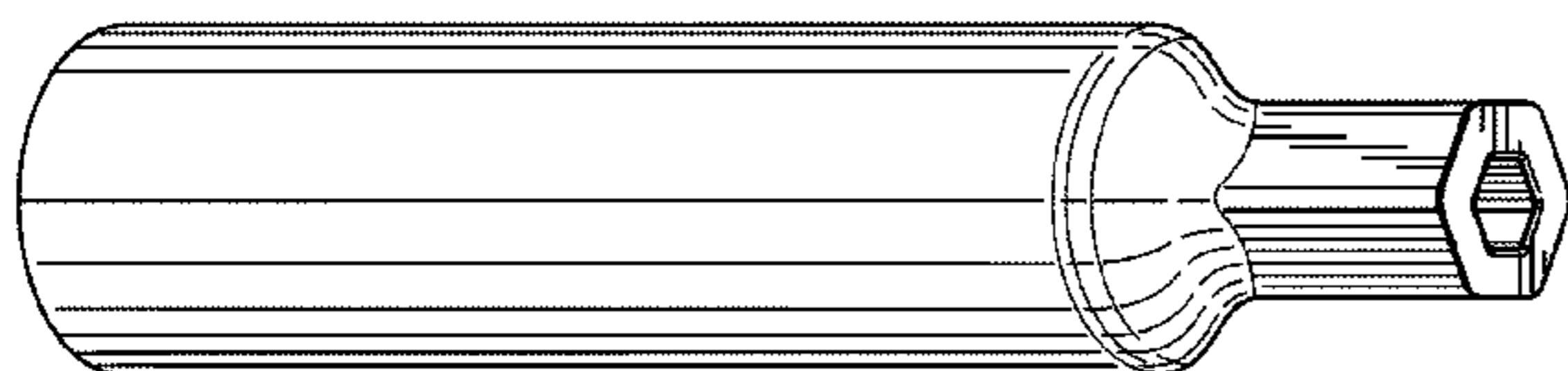

Fig. 1

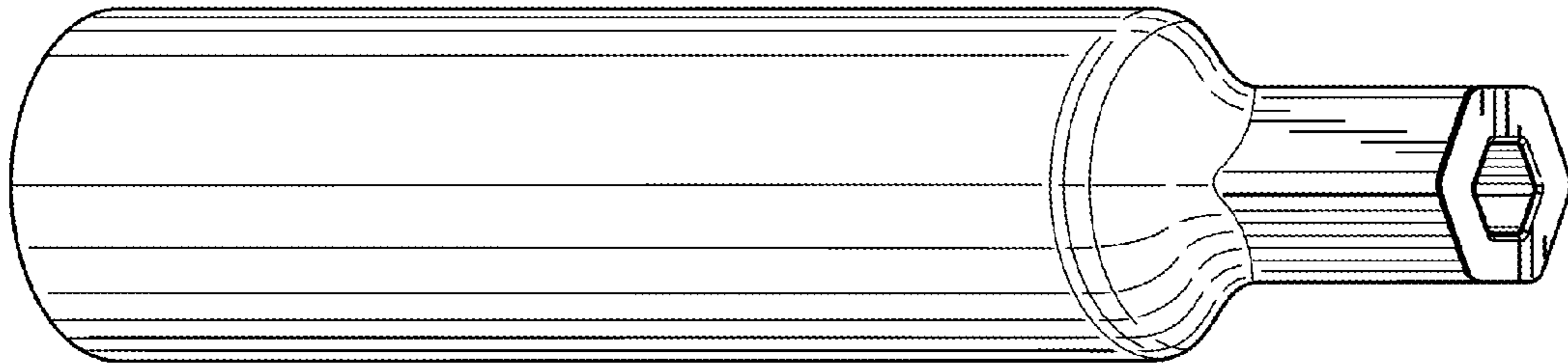

Fig. 2

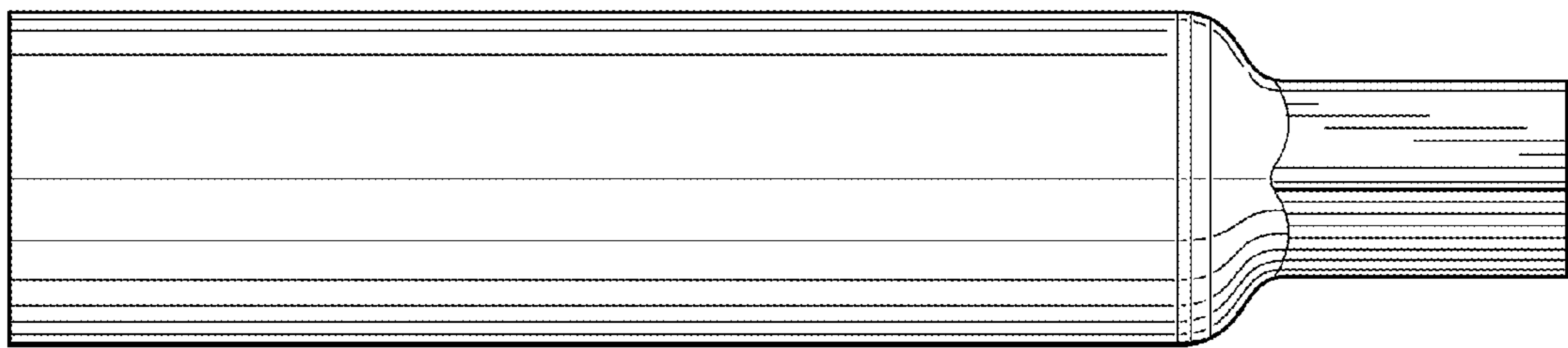

Fig. 3

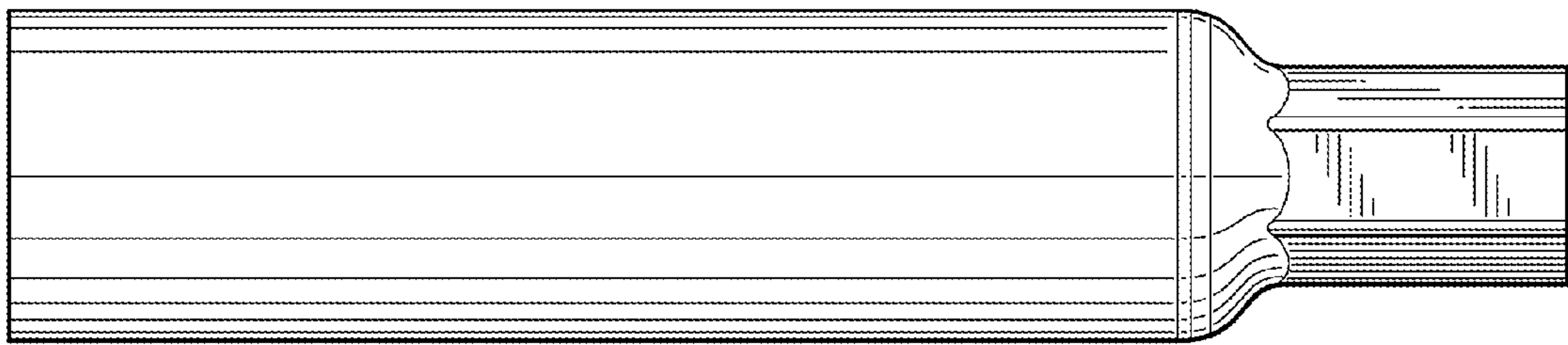

Fig. 4

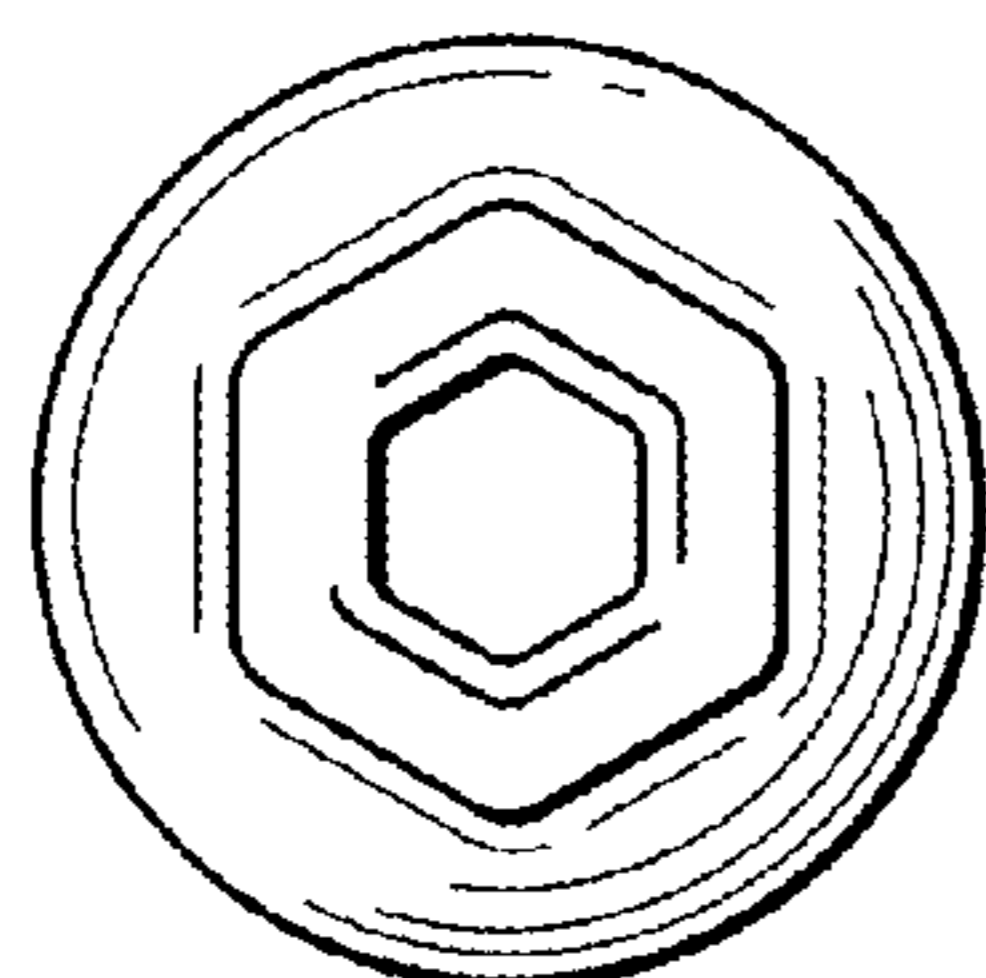

Fig. 5

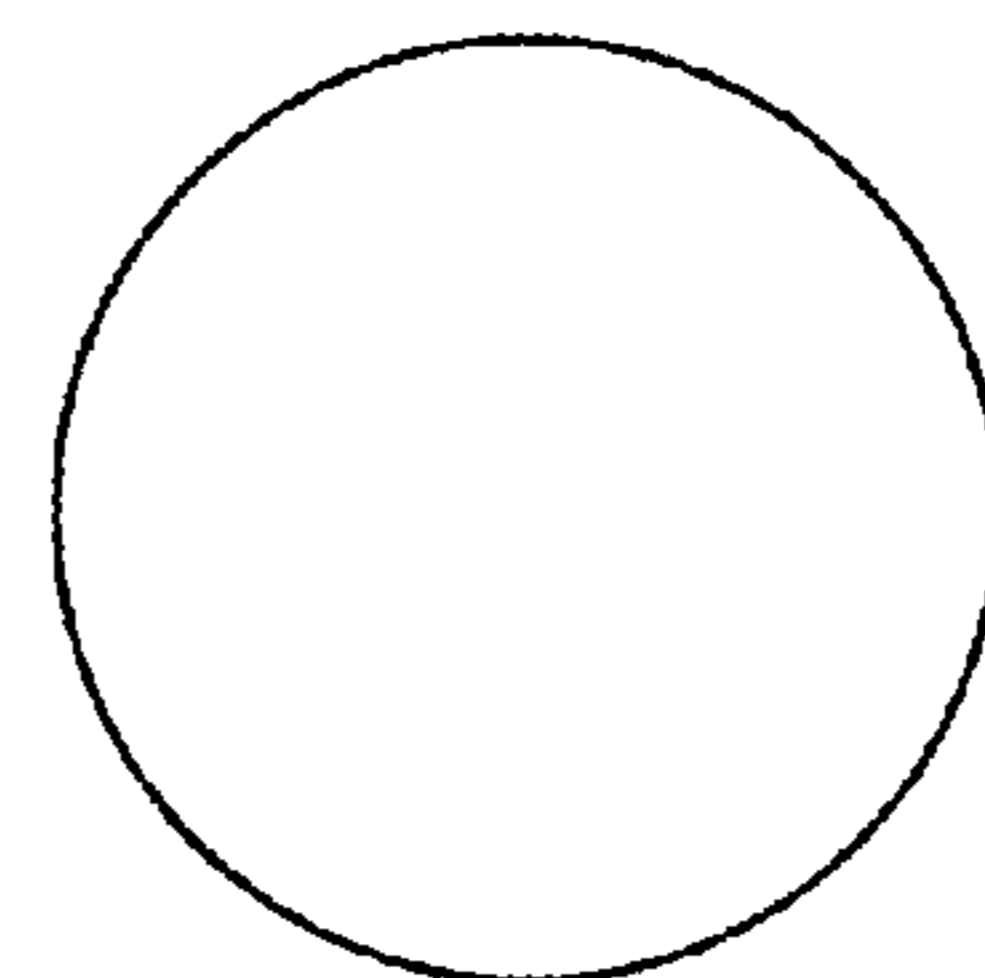

Fig. 6

