



US00D619691S

(12) **United States Design Patent**  
**Nanda**

(10) **Patent No.:** **US D619,691 S**

(45) **Date of Patent:** **\*\* Jul. 13, 2010**

(54) **CASTLE HUMIDIFIER**

(75) Inventor: **Puneet Nanda**, Cerritos, CA (US)

(73) Assignee: **Dr. Fresh, Inc.**, Buena Park, CA (US)

(\*\*) Term: **14 Years**

(21) Appl. No.: **29/328,963**

(22) Filed: **Dec. 4, 2008**

**Related U.S. Application Data**

(63) Continuation-in-part of application No. 29/306,530, filed on Apr. 10, 2008, now Pat. No. Des. 583,036.

(51) **LOC (9) Cl.** ..... **23-04**

(52) **U.S. Cl.** ..... **D23/356; D21/510**

(58) **Field of Classification Search** ..... D23/356, D23/355, 364, 359, 360, 362, 352, 366, 369, D23/332, 333, 335, 336, 342, 351; D21/510, D21/340, 483, 484, 491, 493, 827, 814, 816, D21/494; 422/120, 122; 55/356, 473, 504; 96/97; D14/188, 170, 172; 261/DIG. 17, 261/DIG. 65, DIG. 88, DIG. 31; 446/476; 434/79; D6/434, 451, 610; D10/11, 12; 206/457; D11/157; D30/112, 161; D9/638

See application file for complete search history.

(56) **References Cited**

**U.S. PATENT DOCUMENTS**

D138,602 S \* 8/1944 Merralls ..... D9/638  
D247,385 S \* 2/1978 Rideau ..... D21/510  
D262,902 S 2/1982 Duarte

(Continued)

*Primary Examiner*—T. Chase Nelson

*Assistant Examiner*—David G Muller

(74) *Attorney, Agent, or Firm*—Knobbe, Martens, Olson & Bear, LLP

(57) **CLAIM**

The ornamental design for a castle humidifier, as shown and described.

**DESCRIPTION**

FIG. 1 is a top, front, and right side perspective of an embodiment of a castle humidifier embodying my new design.

FIG. 2 is a front elevation view of the embodiment of FIG. 1.

FIG. 3 is a rear elevation view of the embodiment of FIG. 1.

FIG. 4 is a right side view of the embodiment of FIG. 1.

FIG. 5 left side view of the embodiment of FIG. 1.

FIG. 6 is a top plan view of the embodiment of FIG. 1.

FIG. 7 is a bottom plan view of the embodiment of FIG. 1.

FIG. 8 is a top, front, and right side perspective of a second embodiment of a castle humidifier embodying my new design.

FIG. 9 is a front elevation view of the embodiment of FIG. 8.

FIG. 10 is a rear elevation view of the embodiment of FIG. 8.

FIG. 11 is a right side view of the embodiment of FIG. 8.

FIG. 12 left side view of the embodiment of FIG. 8.

FIG. 13 is a top plan view of the embodiment of FIG. 8; and,

FIG. 14 is a bottom plan view of the embodiment of FIG. 8.

The broken lines illustrate portions of the humidifier that form no part of the claimed design.

**1 Claim, 14 Drawing Sheets**

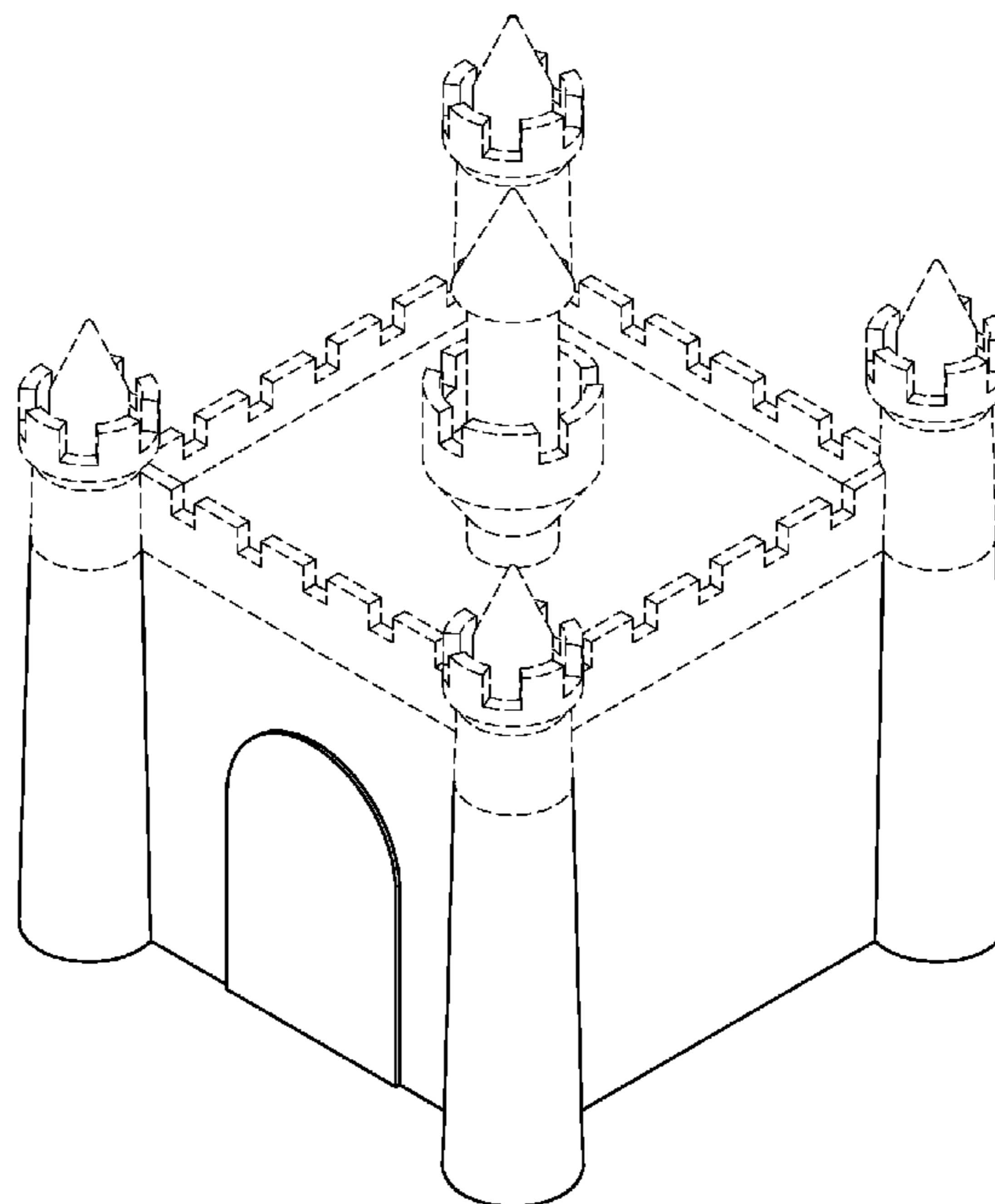

# US D619,691 S

Page 2

---

## U.S. PATENT DOCUMENTS

D276,634 S	12/1984	Pope	
D309,046 S *	7/1990	Andersen .....	D30/112
D311,432 S	10/1990	Cattoni	
D333,328 S	2/1993	Aker et al.	
D342,697 S	12/1993	Delson	
5,337,700 A *	8/1994	Toft .....	D30/161
D354,401 S *	1/1995	Kim .....	D10/12
5,394,989 A	3/1995	Delson	
D367,694 S *	3/1996	van Huystee .....	D21/510
D368,393 S	4/1996	Darneille	
D372,056 S	7/1996	Norton	
D393,303 S	4/1998	Van Wagenen	
D403,029 S *	12/1998	Van Wagenen .....	D21/494
D407,861 S *	4/1999	Teng .....	D30/112
6,581,822 B1	6/2003	Garran	
D493,506 S	7/2004	Birchenough	
D498,083 S	11/2004	Bishop	
D501,584 S *	2/2005	Abajian .....	D30/161
D546,903 S *	7/2007	Wilson et al. ....	D21/510
D554,060 S *	10/2007	Park .....	D30/112
D577,952 S *	10/2008	Goode et al. ....	D6/610
D583,036 S *	12/2008	Nanda .....	D23/356
2004/0176012 A1	9/2004	Hirtz	

\* cited by examiner

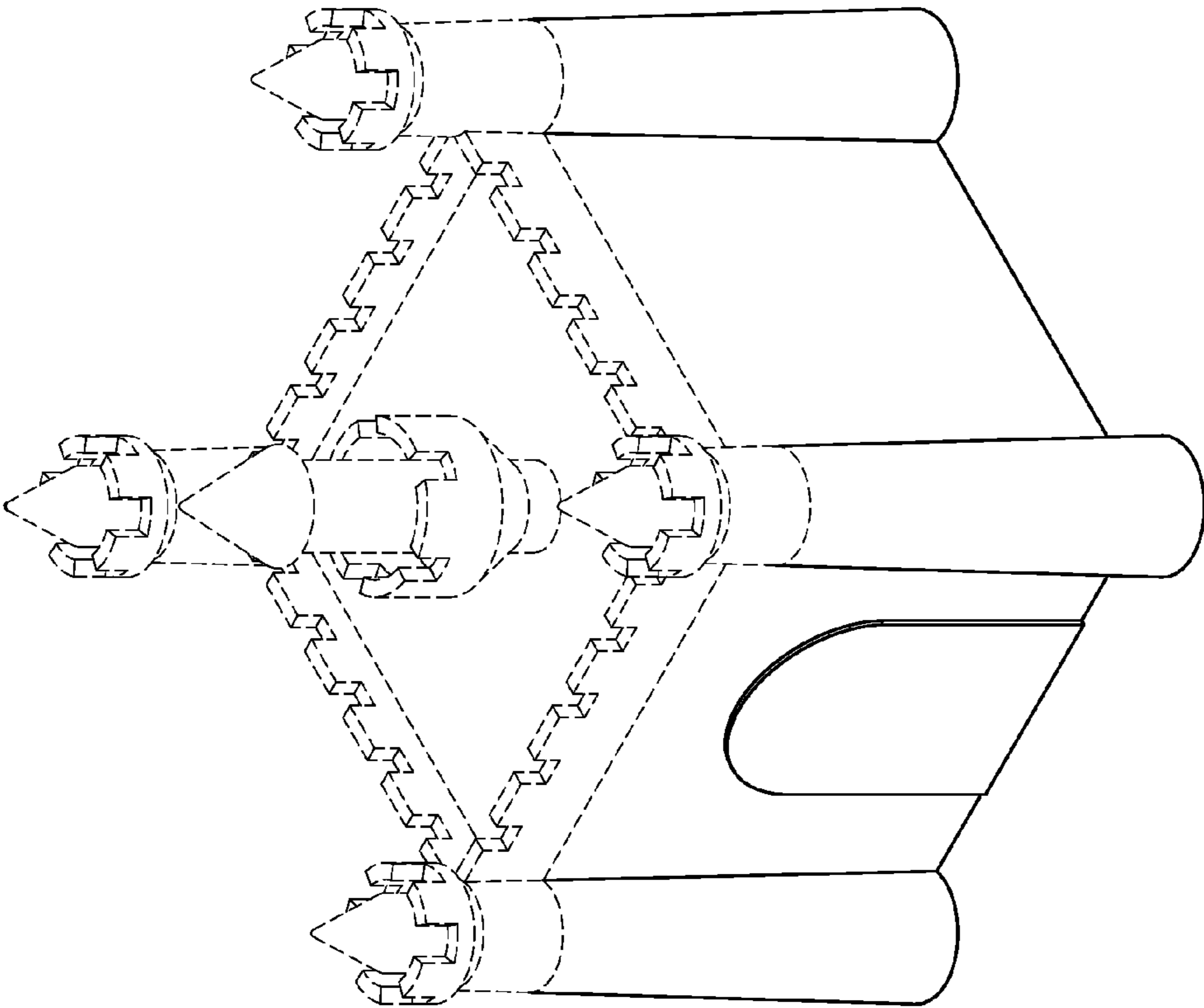

*FIG. 1*

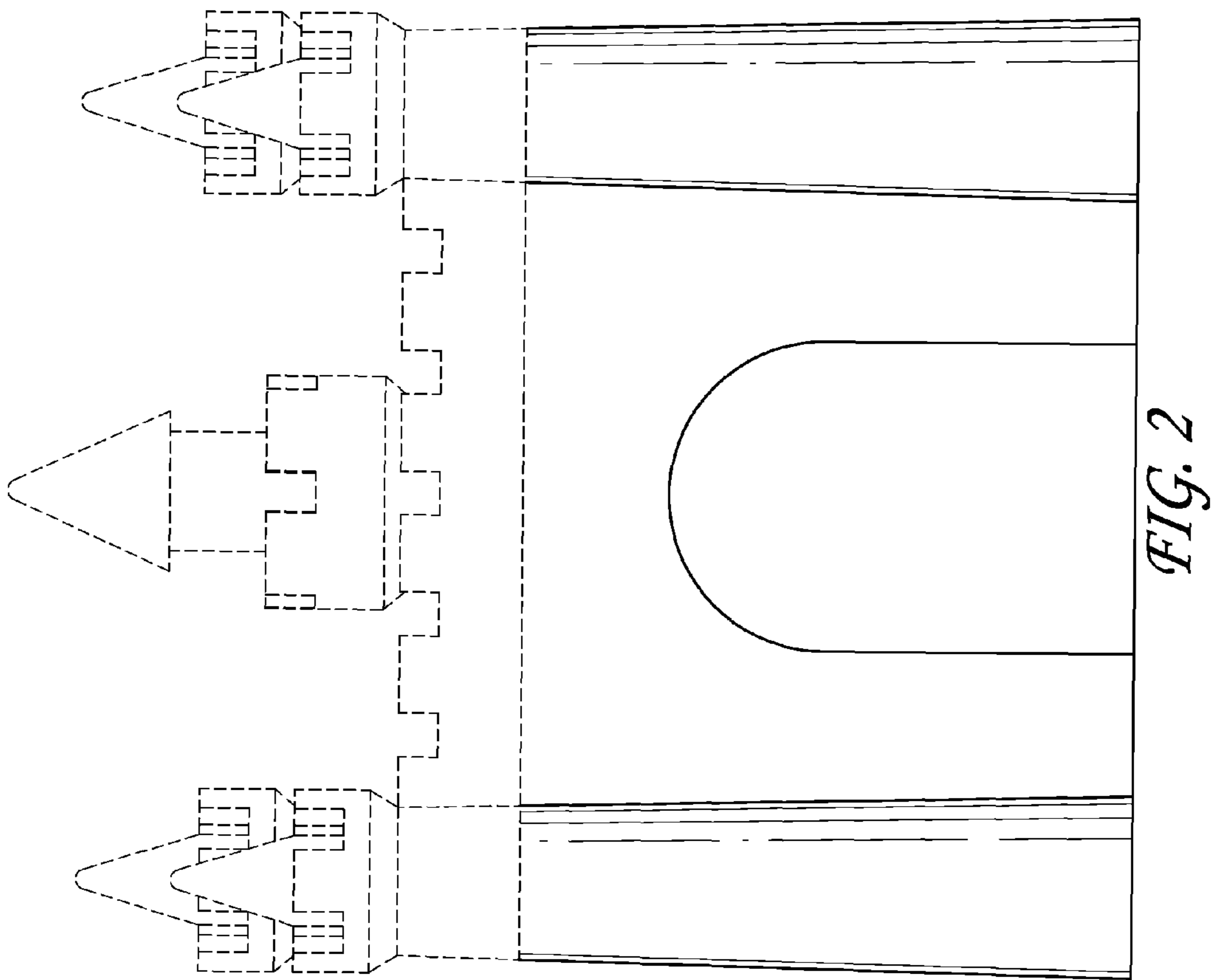

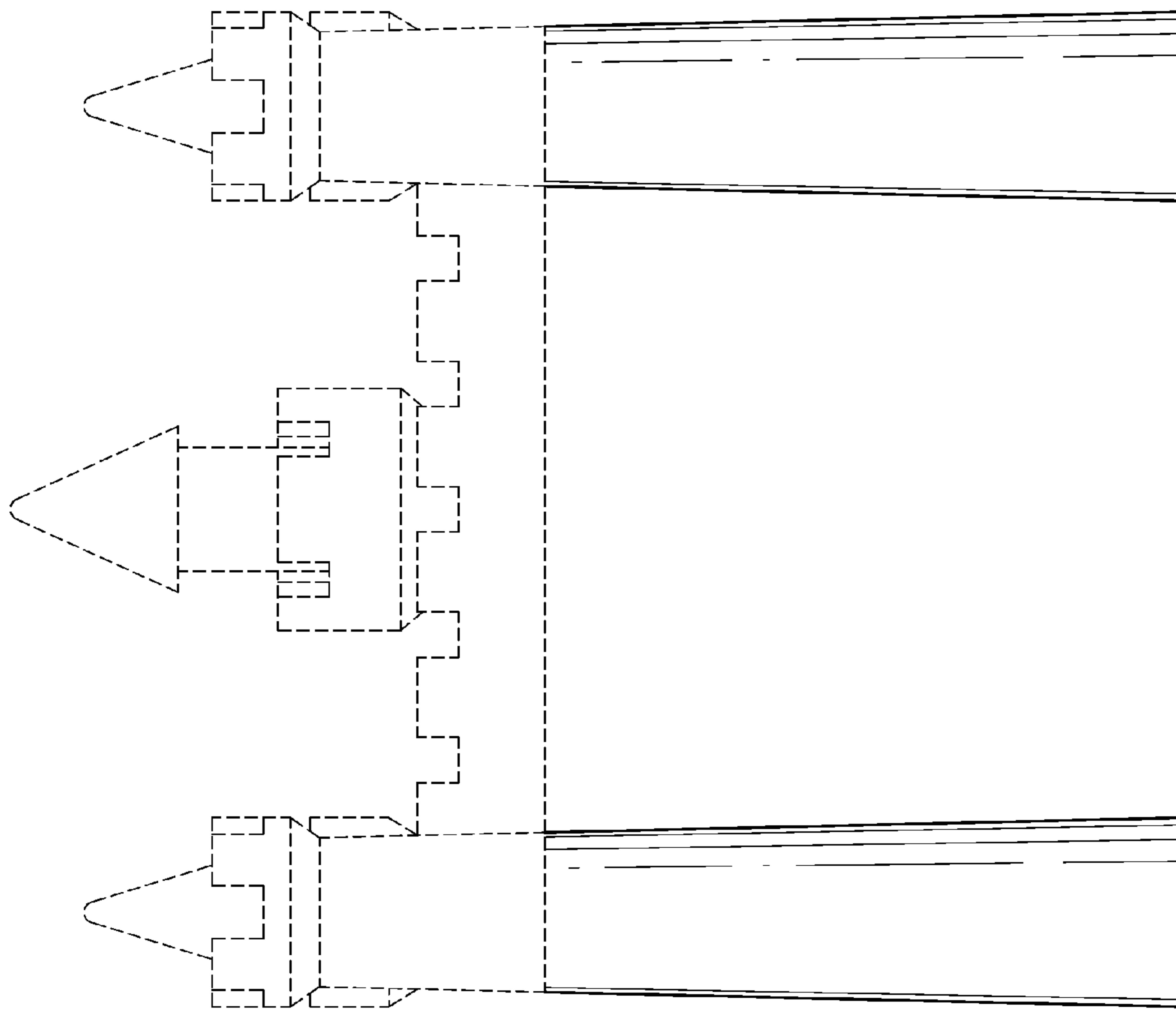

FIG. 3

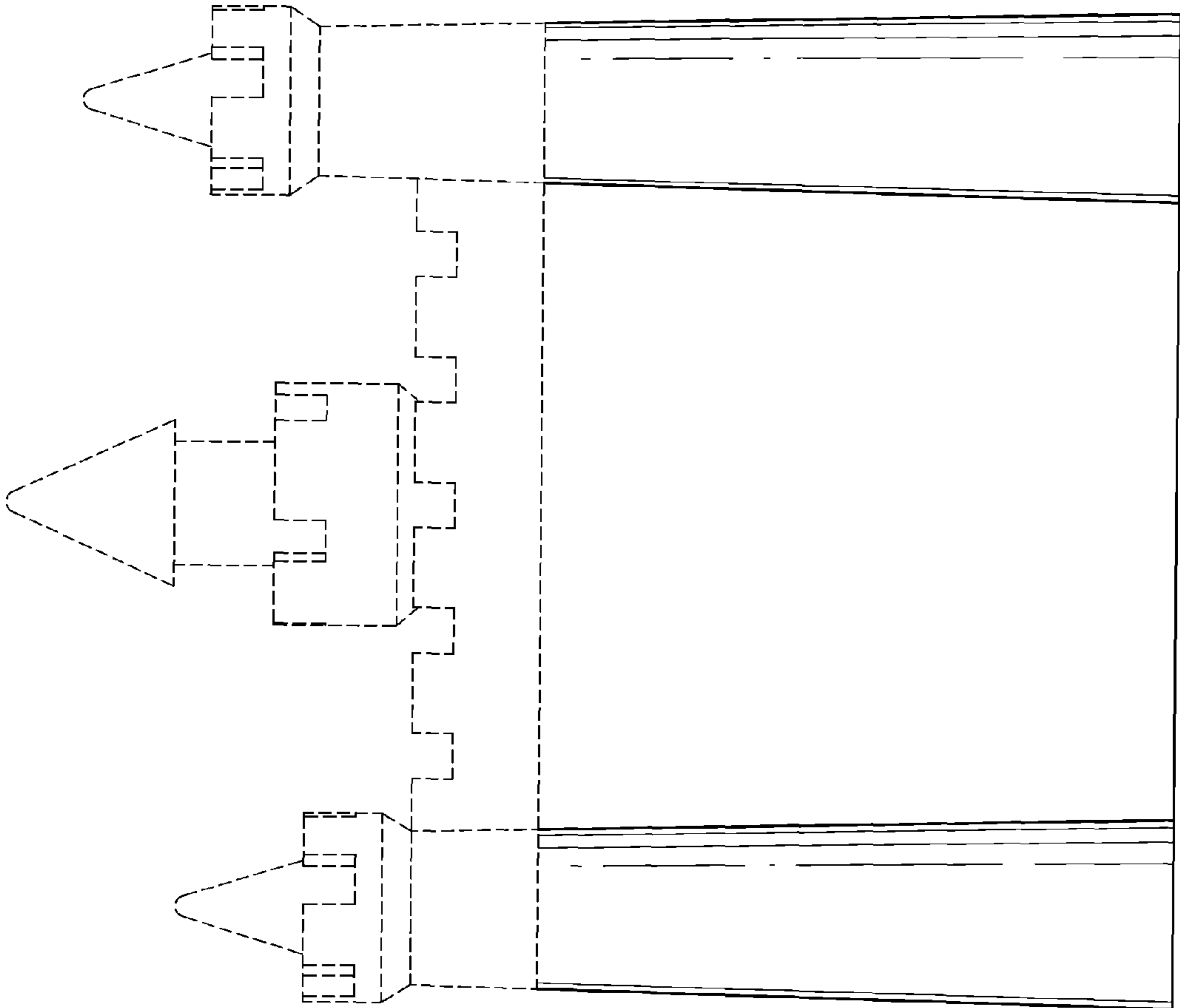
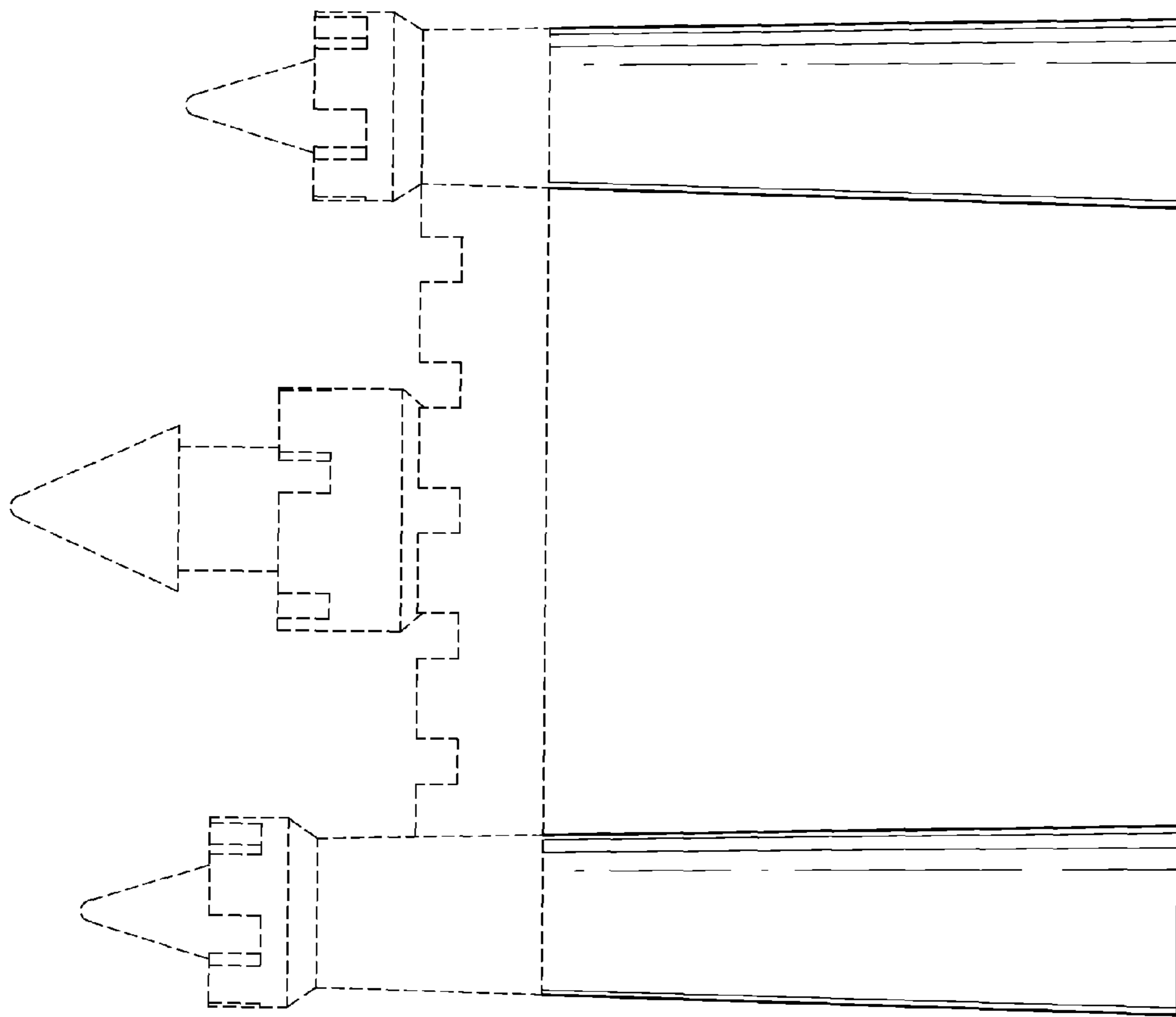
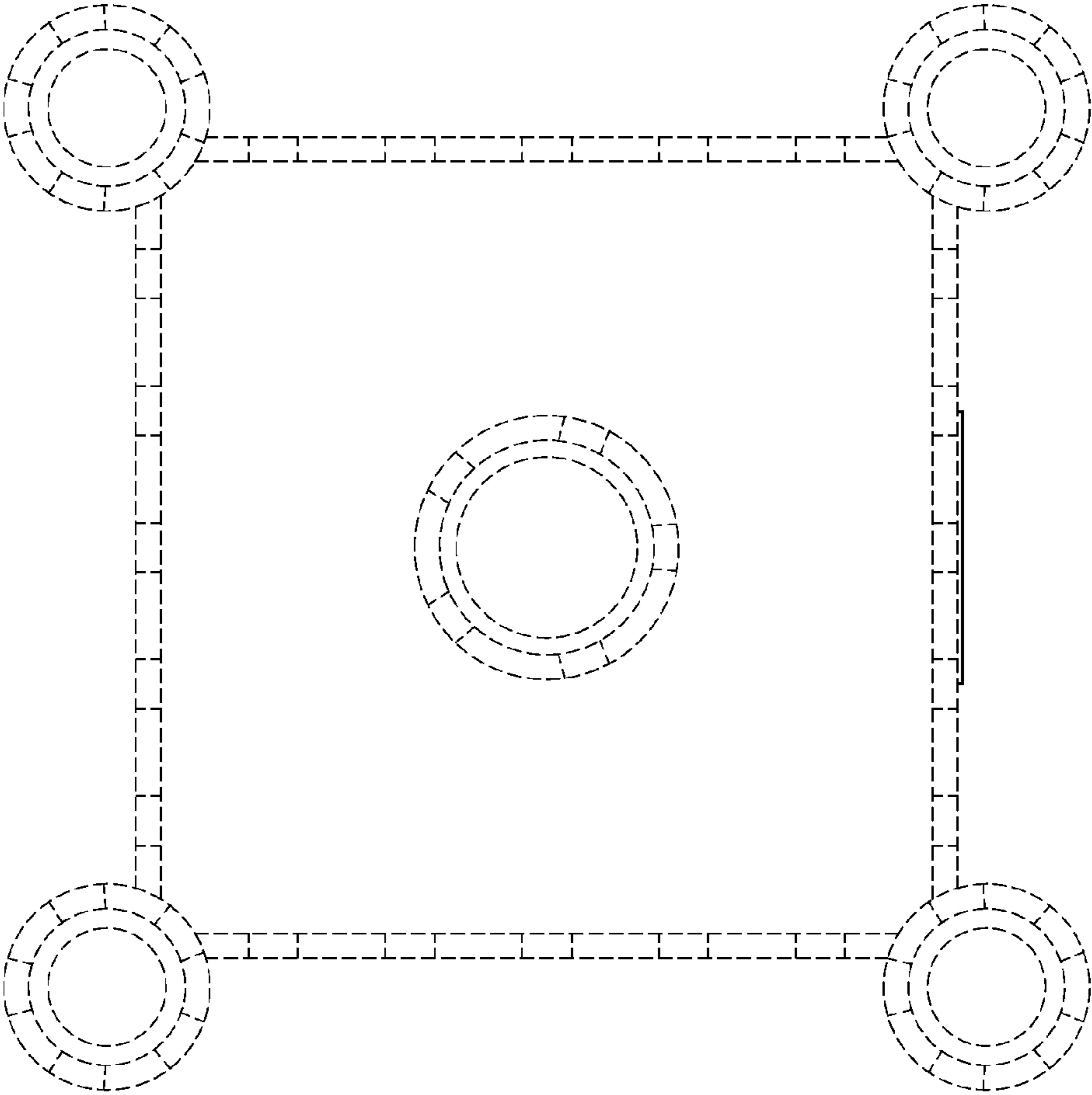

FIG. 4

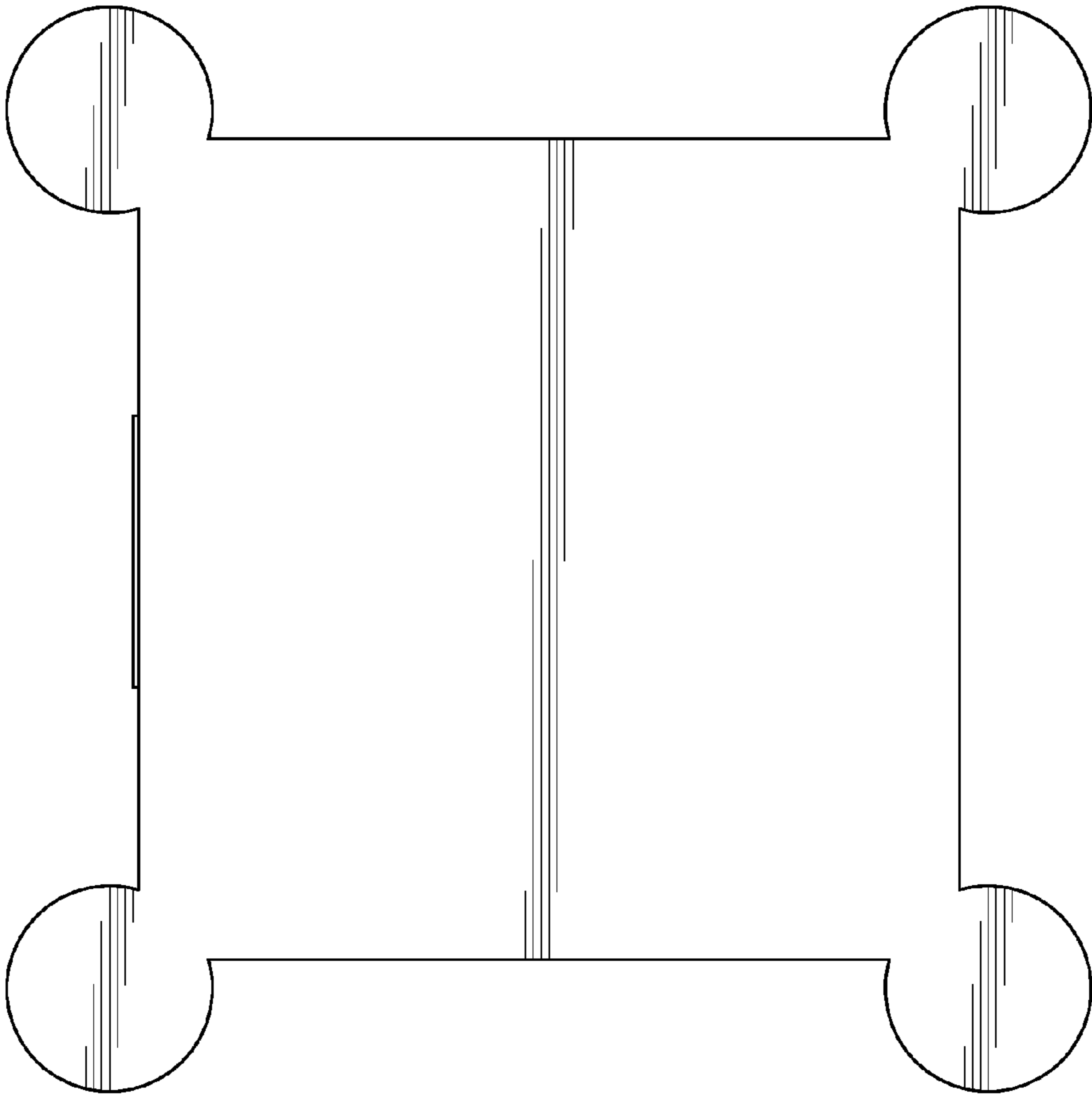

*FIG. 5*

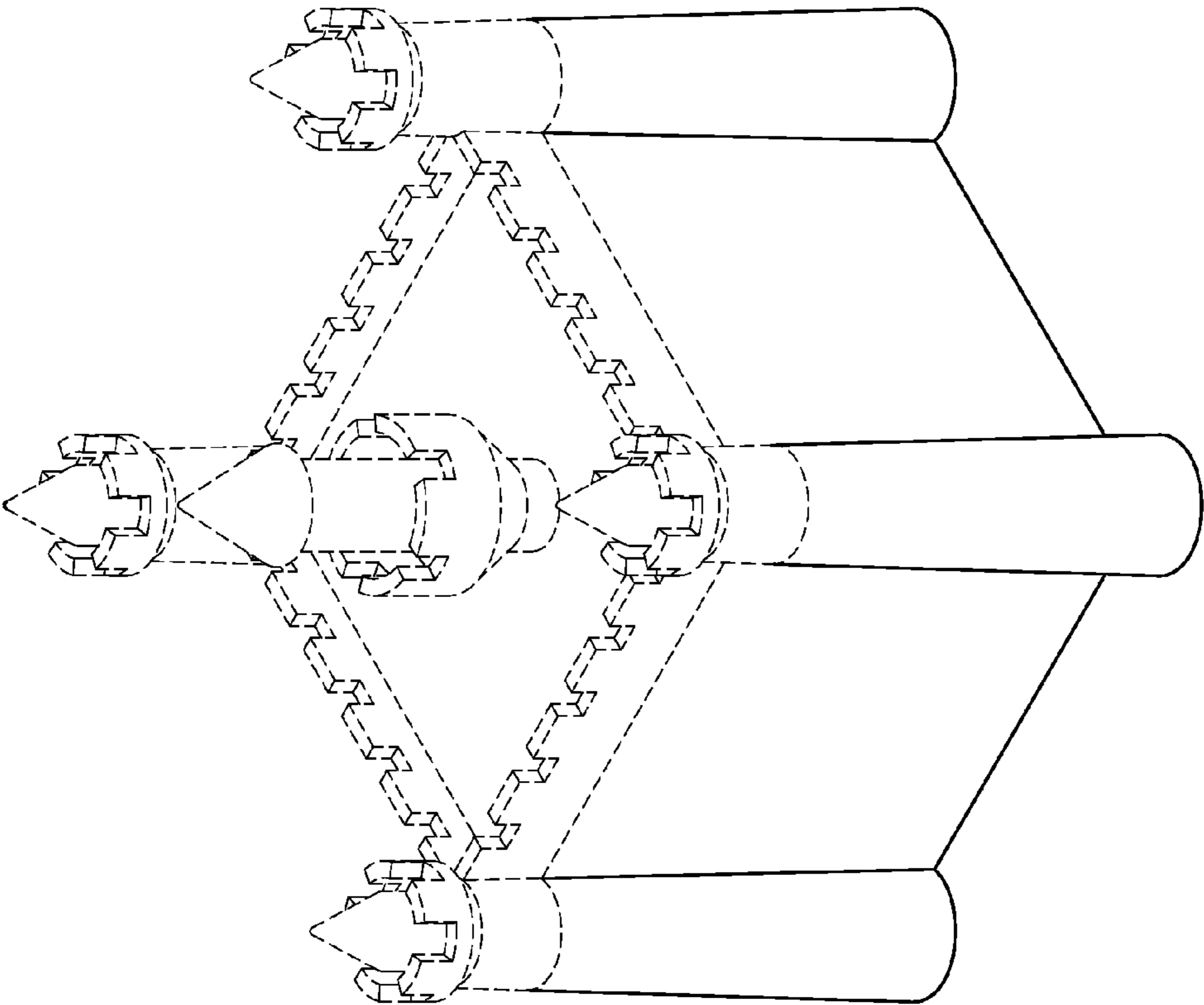

*FIG. 6*

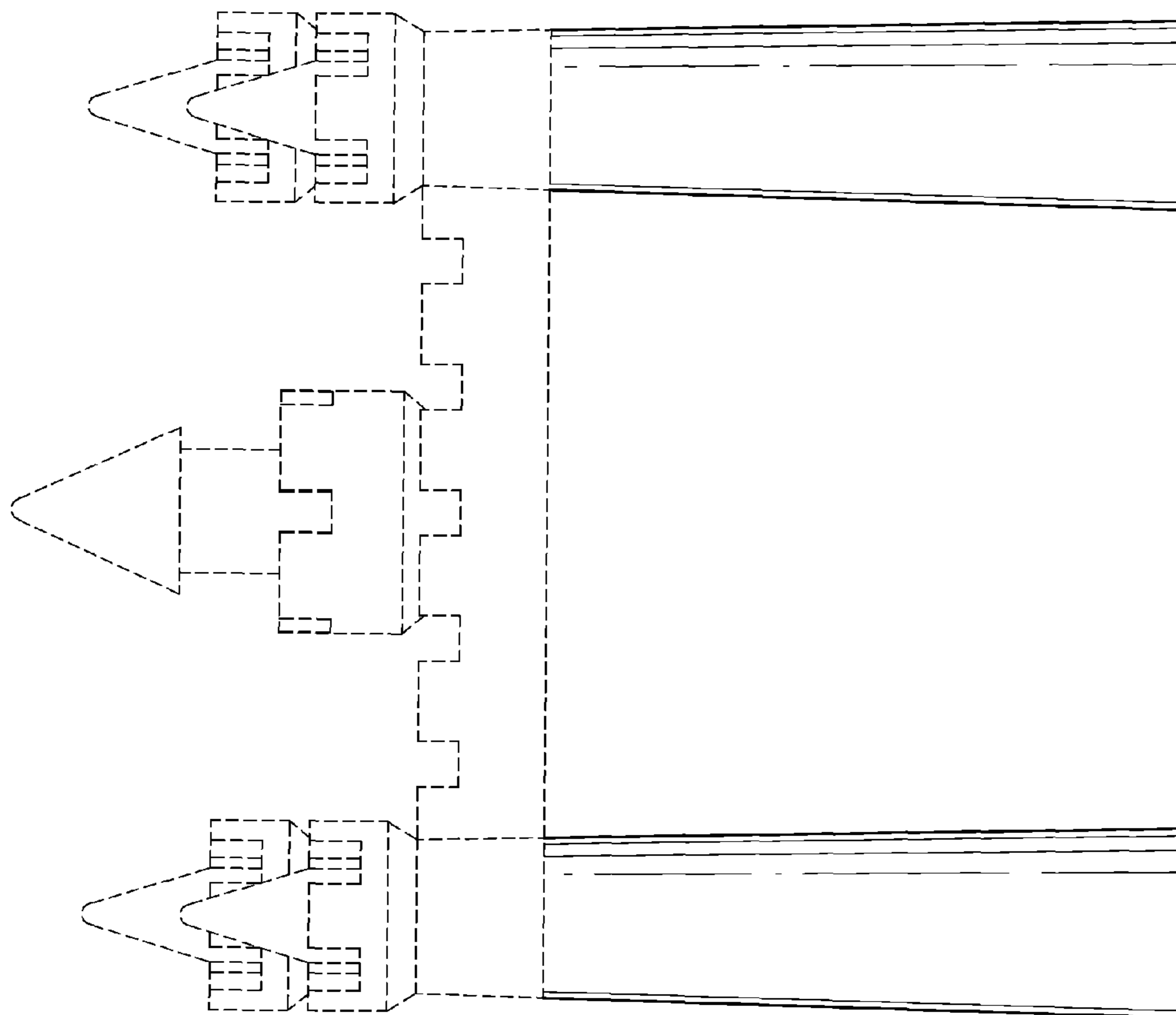



*FIG. 7*



*FIG. 8*



*FIG. 9*

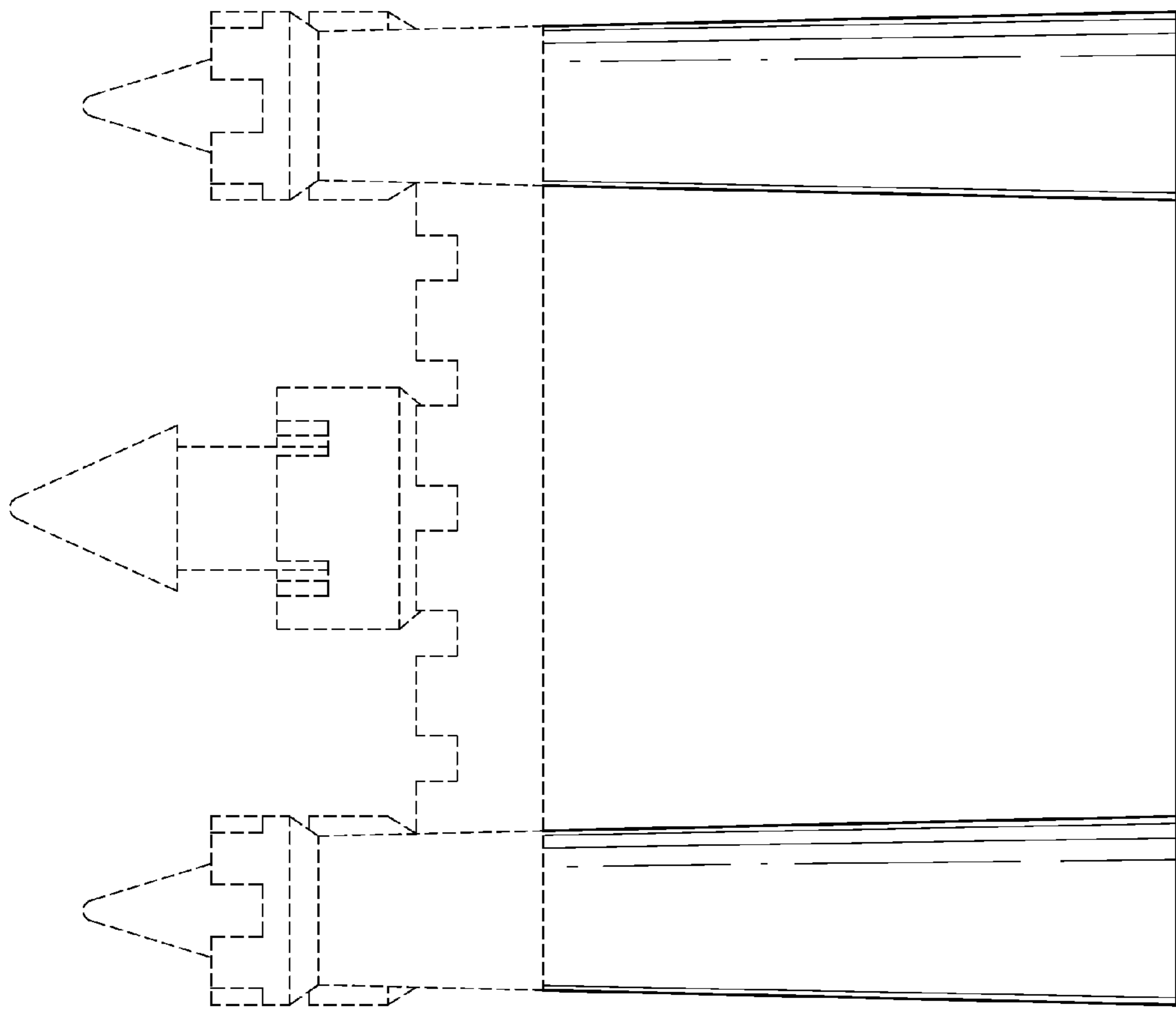

*FIG. 10*

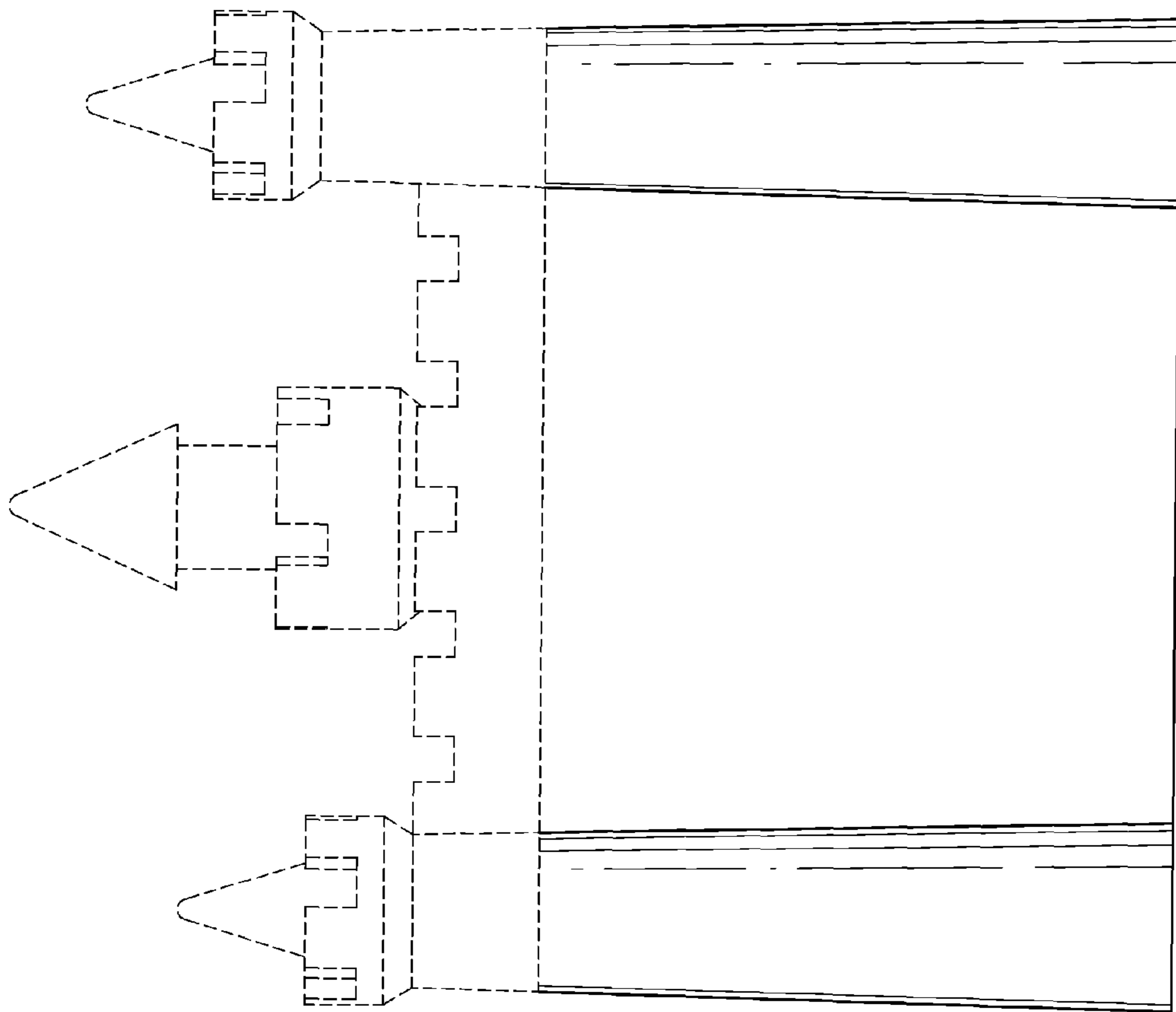

*FIG. 11*

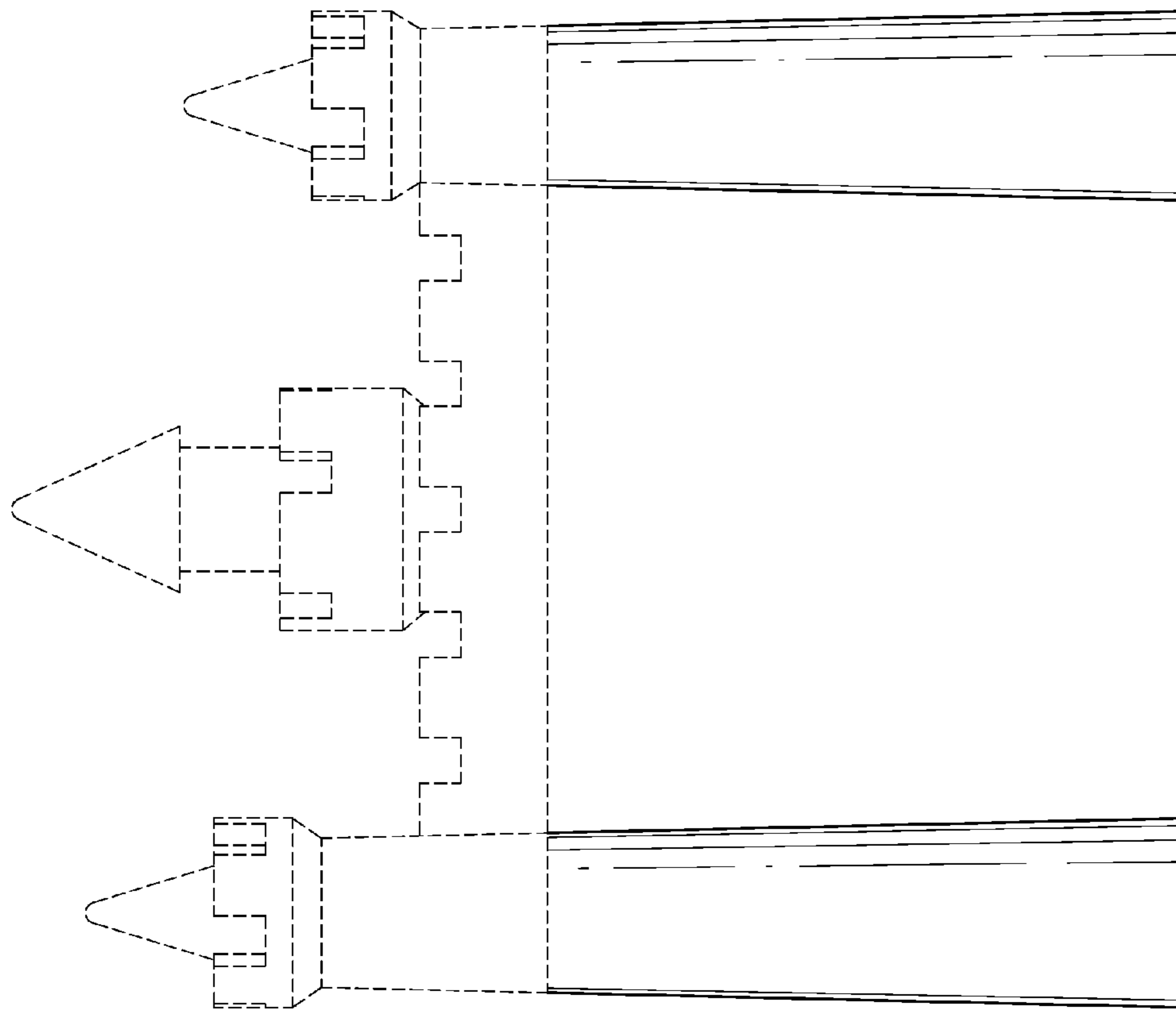

*FIG. 12*

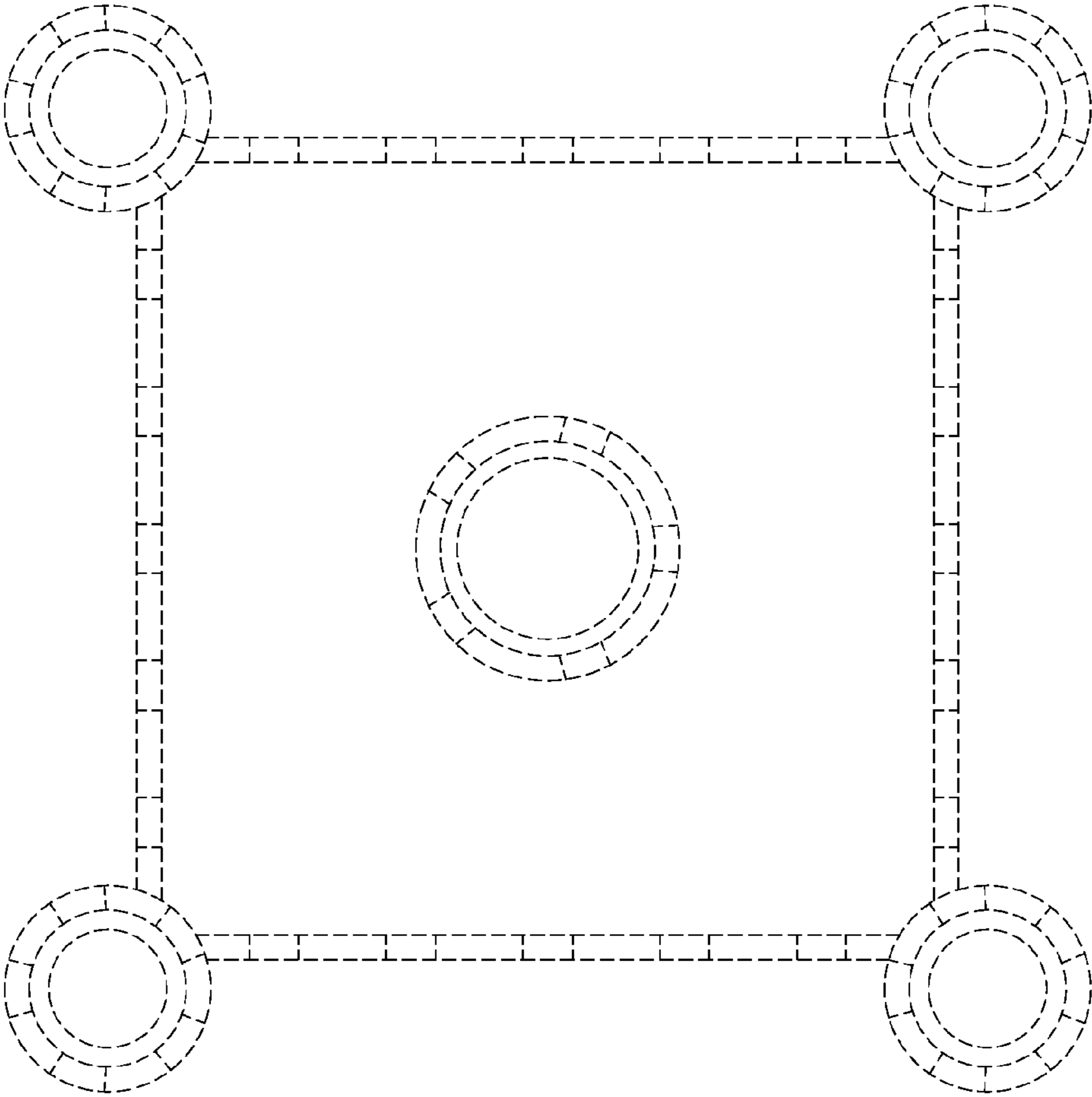

*FIG. 13*

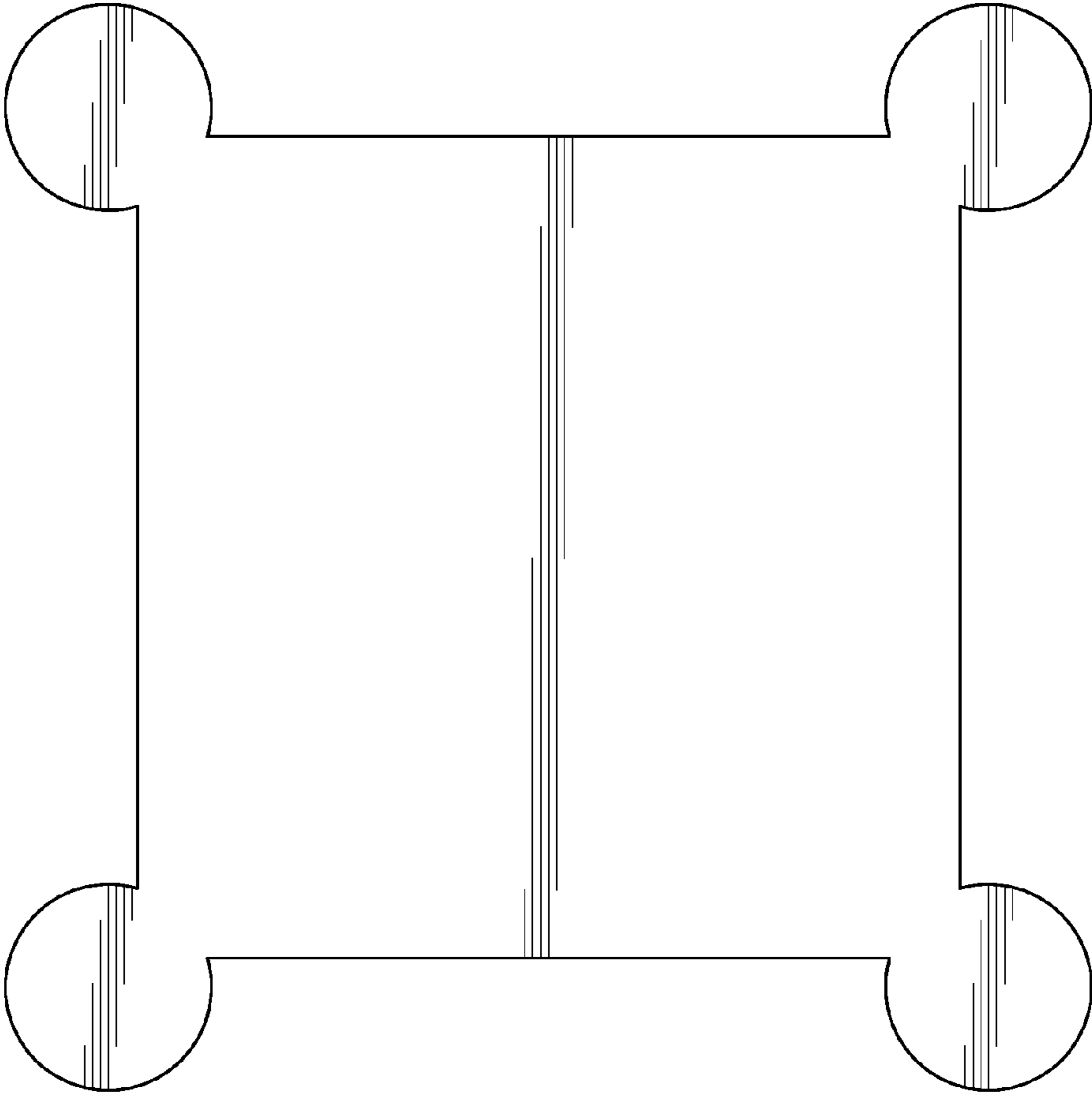

*FIG. 14*