



US00D619567S

(12) **United States Design Patent**  
**Kwon et al.**

(10) **Patent No.:** **US D619,567 S**  
(45) **Date of Patent:** **\*\* Jul. 13, 2010**

(54) **CRADLE FOR AN EARSET**

(75) Inventors: **Jong-Chan Kwon**, Yongin-si (KR);  
**Chol-Ho Hwang**, Suwon-si (KR)

(73) Assignee: **Samsung Electronics Co., Ltd.**,  
Suwon-Si (KR)

(\*\*) Term: **14 Years**

(21) Appl. No.: **29/322,193**

(22) Filed: **Jul. 30, 2008**

(51) **LOC (9) Cl.** ..... **14-01**

(52) **U.S. Cl.** ..... **D14/224; D14/223**

(58) **Field of Classification Search** ..... D14/205,  
D14/206, 223, 224, 224.1, 217, 149, 248,  
D14/251, 253, 238.1, 434; D13/107, 108,  
D13/144; 439/529, 668; 455/557, 569.1,  
455/575.9; 379/420.01, 420.02, 420.3, 420.04,  
379/428.01, 428.02, 428.03, 428.04, 454,  
379/446; 320/115

See application file for complete search history.

(56) **References Cited**

**U.S. PATENT DOCUMENTS**

D315,543 S \* 3/1991 Soren et al. .... D13/144  
5,170,067 A \* 12/1992 Baum et al. .... 307/10.1  
D349,096 S \* 7/1994 Hyvonen ..... D13/107  
5,490,213 A \* 2/1996 Huang ..... 379/442

D384,937 S \* 10/1997 Liu ..... D13/108  
D433,005 S \* 10/2000 McGugan ..... D14/155  
D444,123 S \* 6/2001 Hofstede et al. .... D13/108  
6,512,826 B1 \* 1/2003 Kim ..... 379/420.04  
D496,029 S \* 9/2004 Skulley et al. .... D14/224  
D530,280 S \* 10/2006 Krieger et al. .... D13/144  
D546,287 S \* 7/2007 Tanishita ..... D13/144  
D554,585 S \* 11/2007 Nazar ..... D13/110  
D604,699 S \* 11/2009 Yamamoto ..... D13/144

\* cited by examiner

*Primary Examiner*—Paula Greene

(74) *Attorney, Agent, or Firm*—Staas & Halsey LLP

(57) **CLAIM**

The ornamental design for a cradle for an earset, as shown and described.

**DESCRIPTION**

FIG. 1 is a perspective view of a cradle for an earset according to our new design;

FIG. 2 is a front elevational view thereof;

FIG. 3 is a rear elevational view thereof;

FIG. 4 is a left side elevational view thereof;

FIG. 5 is a right side elevational view thereof;

FIG. 6 is a top plan view thereof; and,

FIG. 7 is a bottom plan view thereof.

**1 Claim, 7 Drawing Sheets**

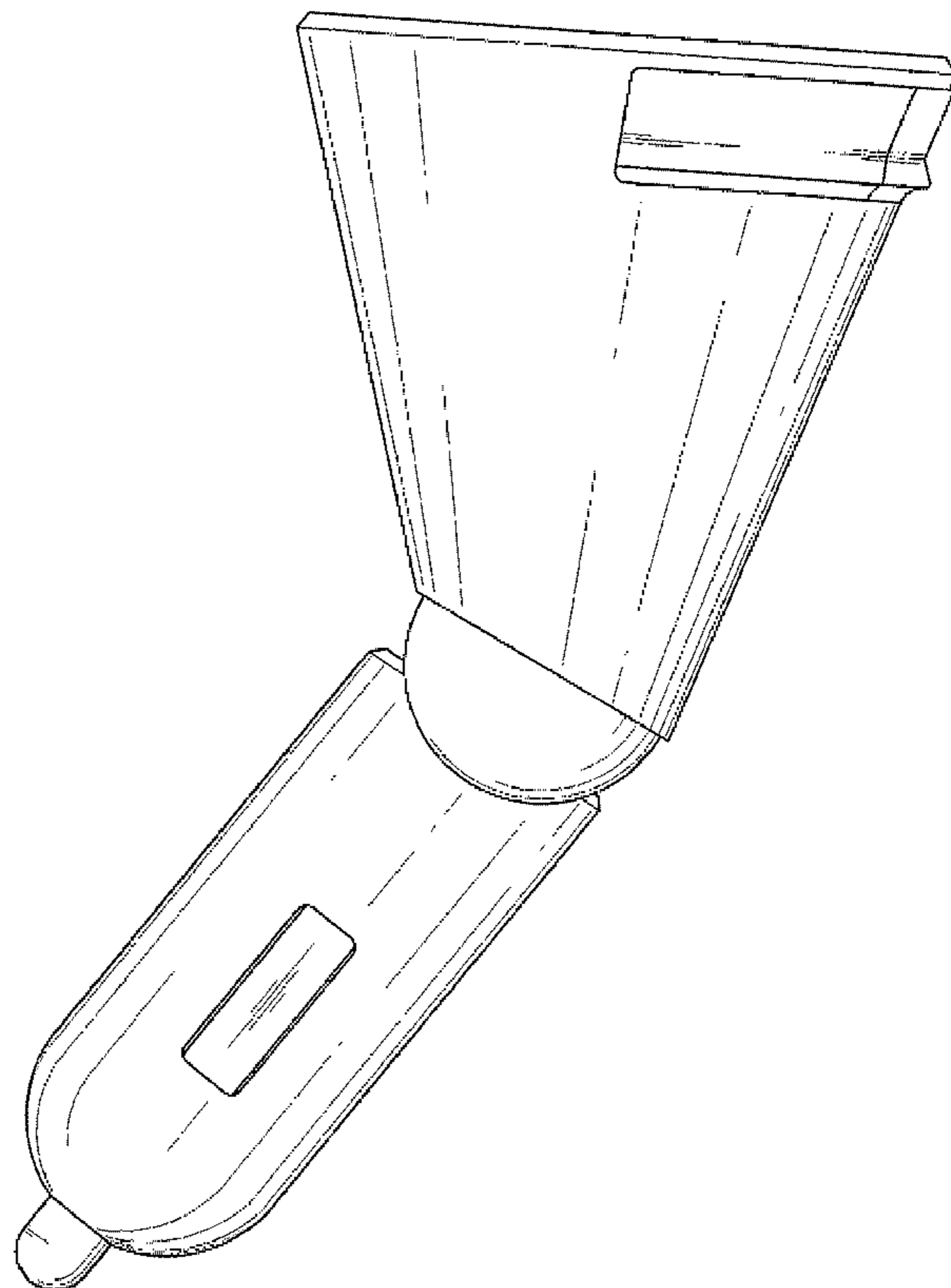
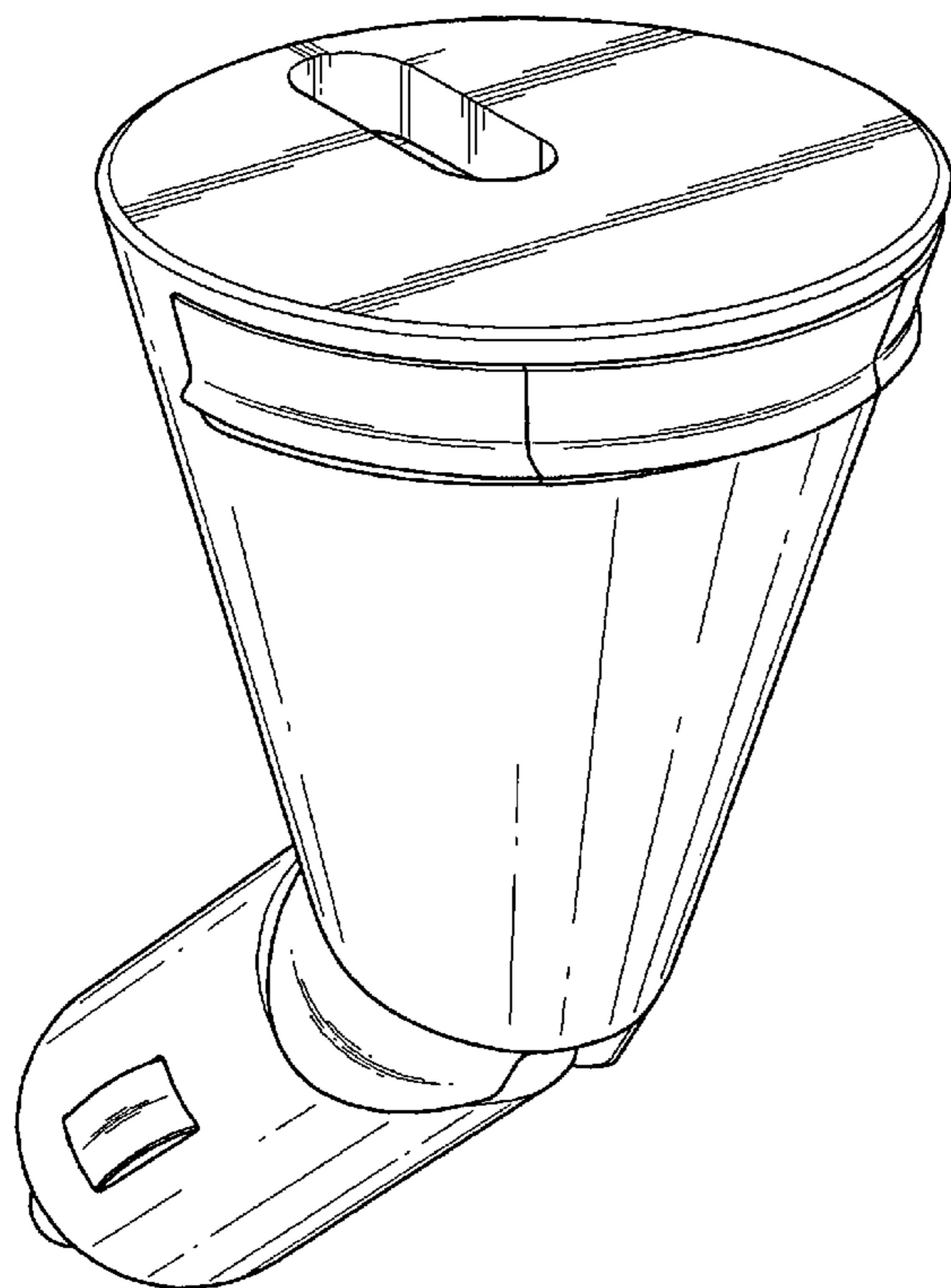

FIG.1

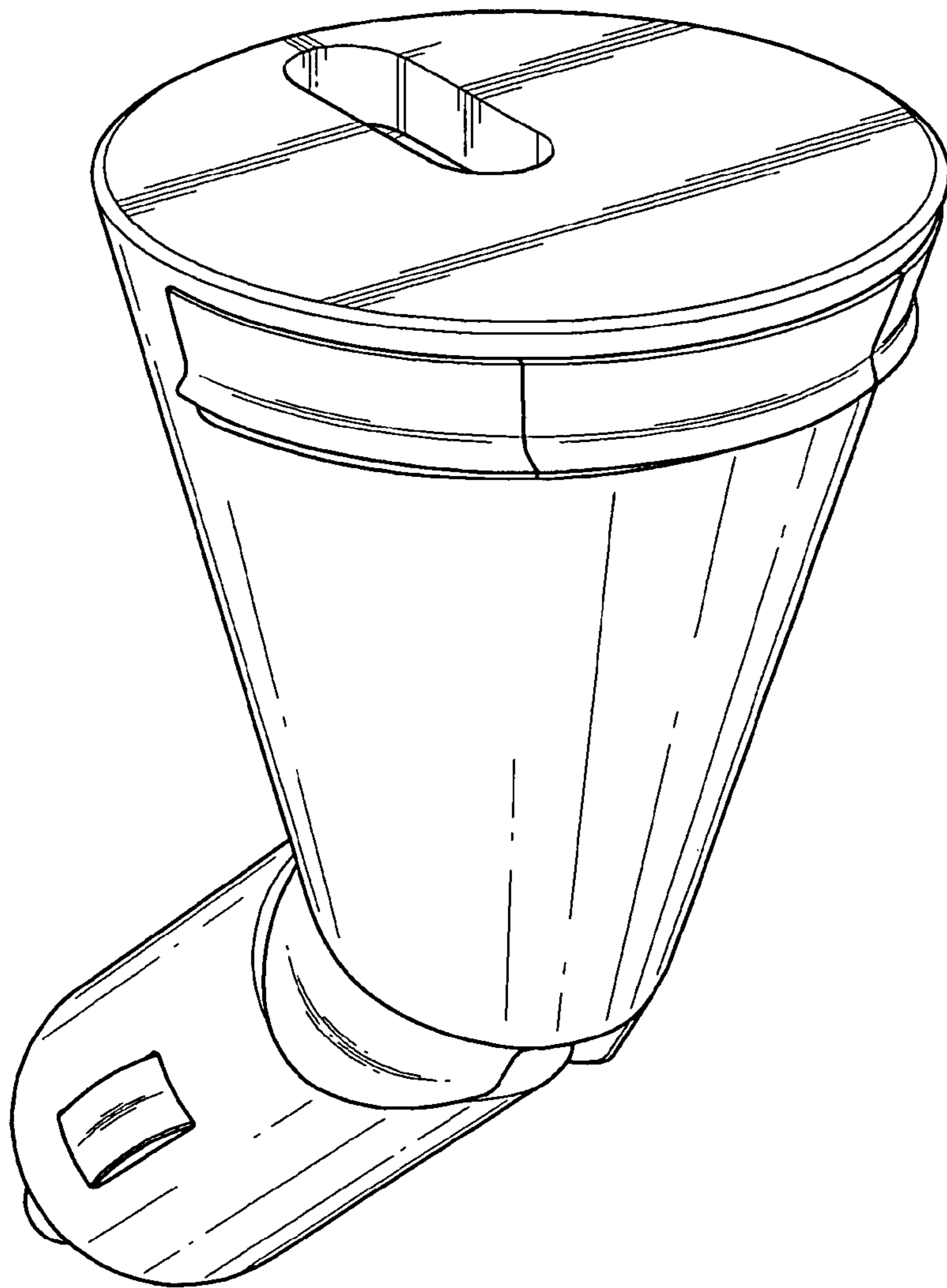

FIG.2

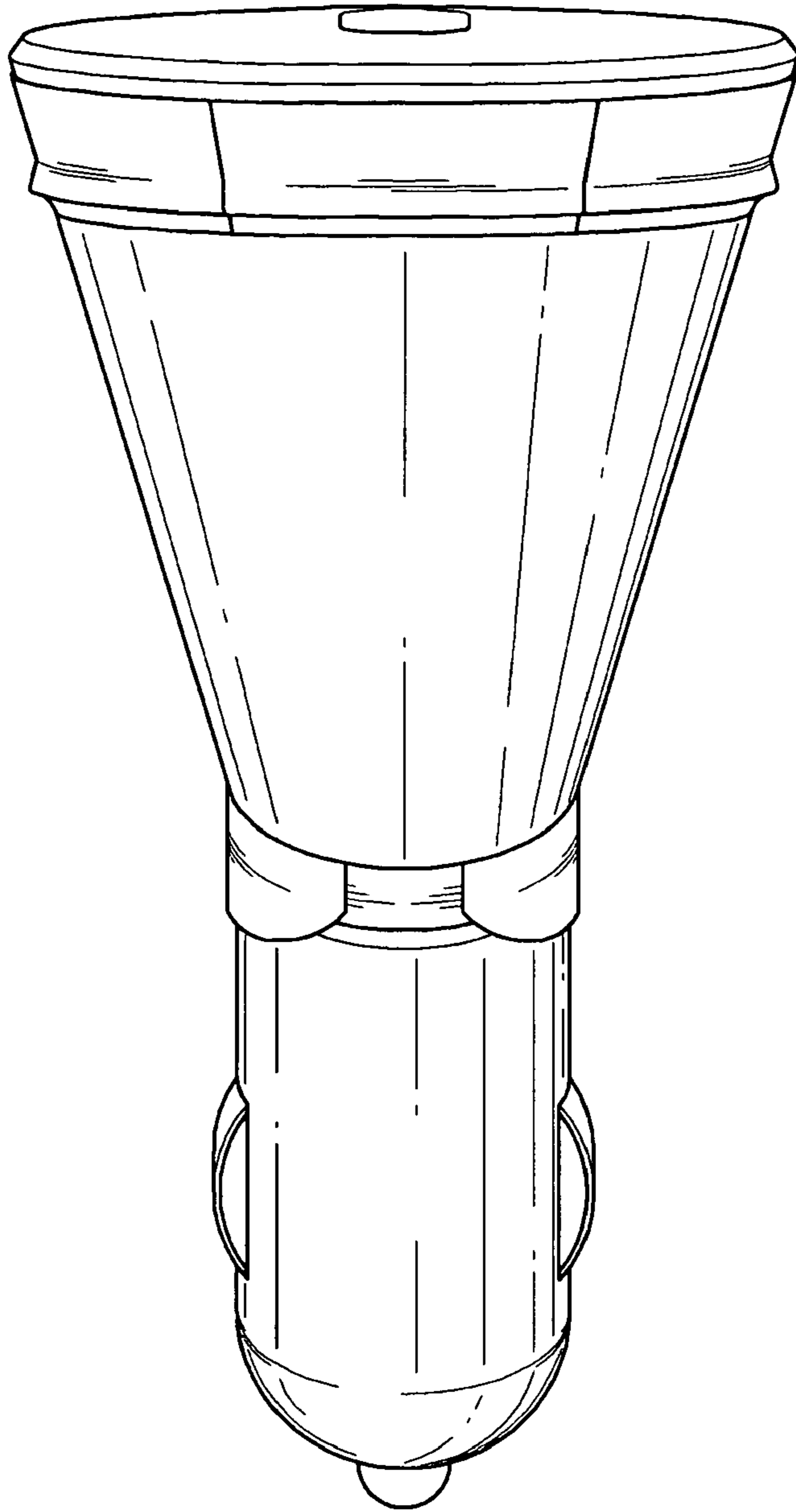

FIG.3

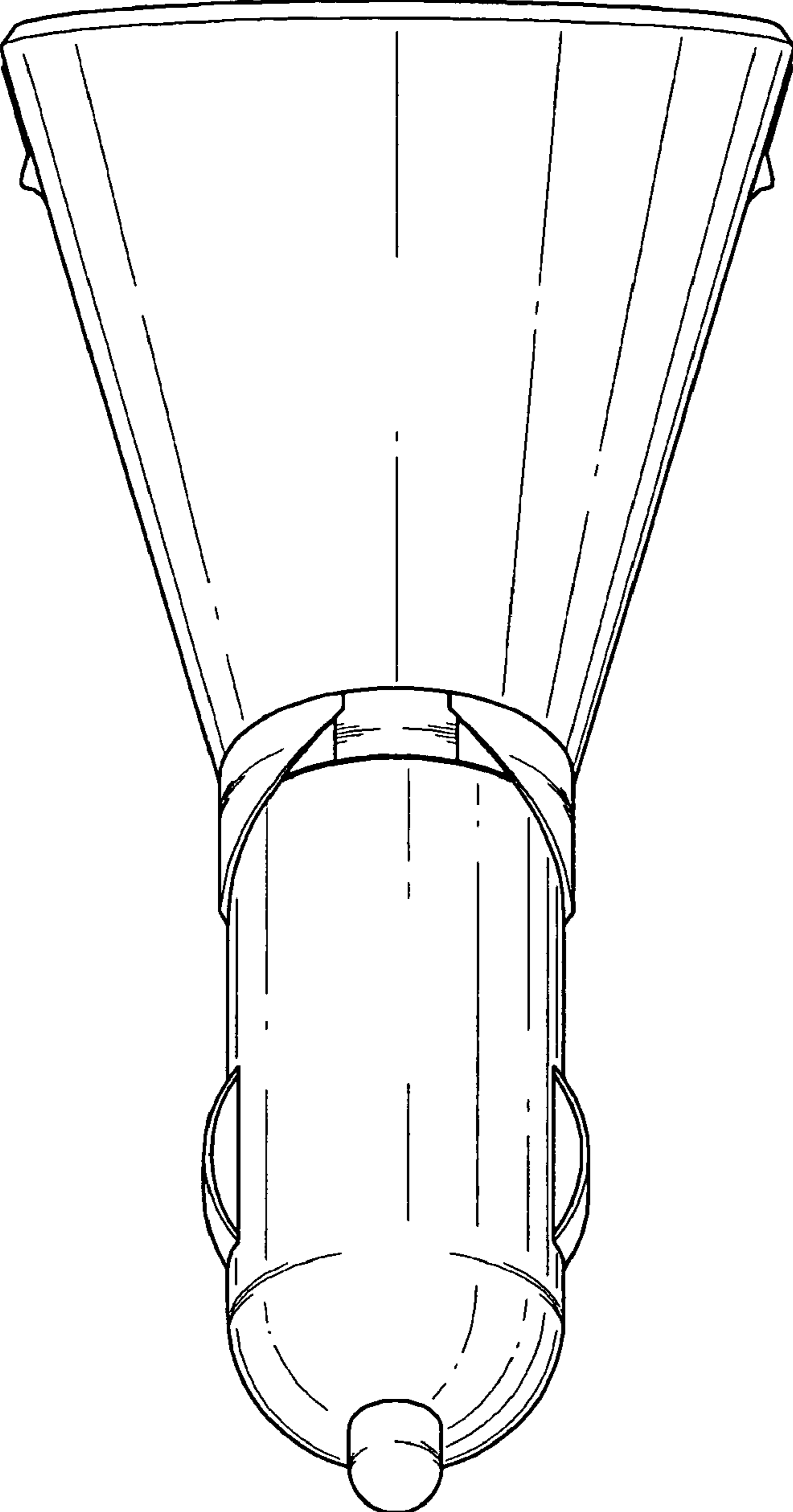

FIG.4

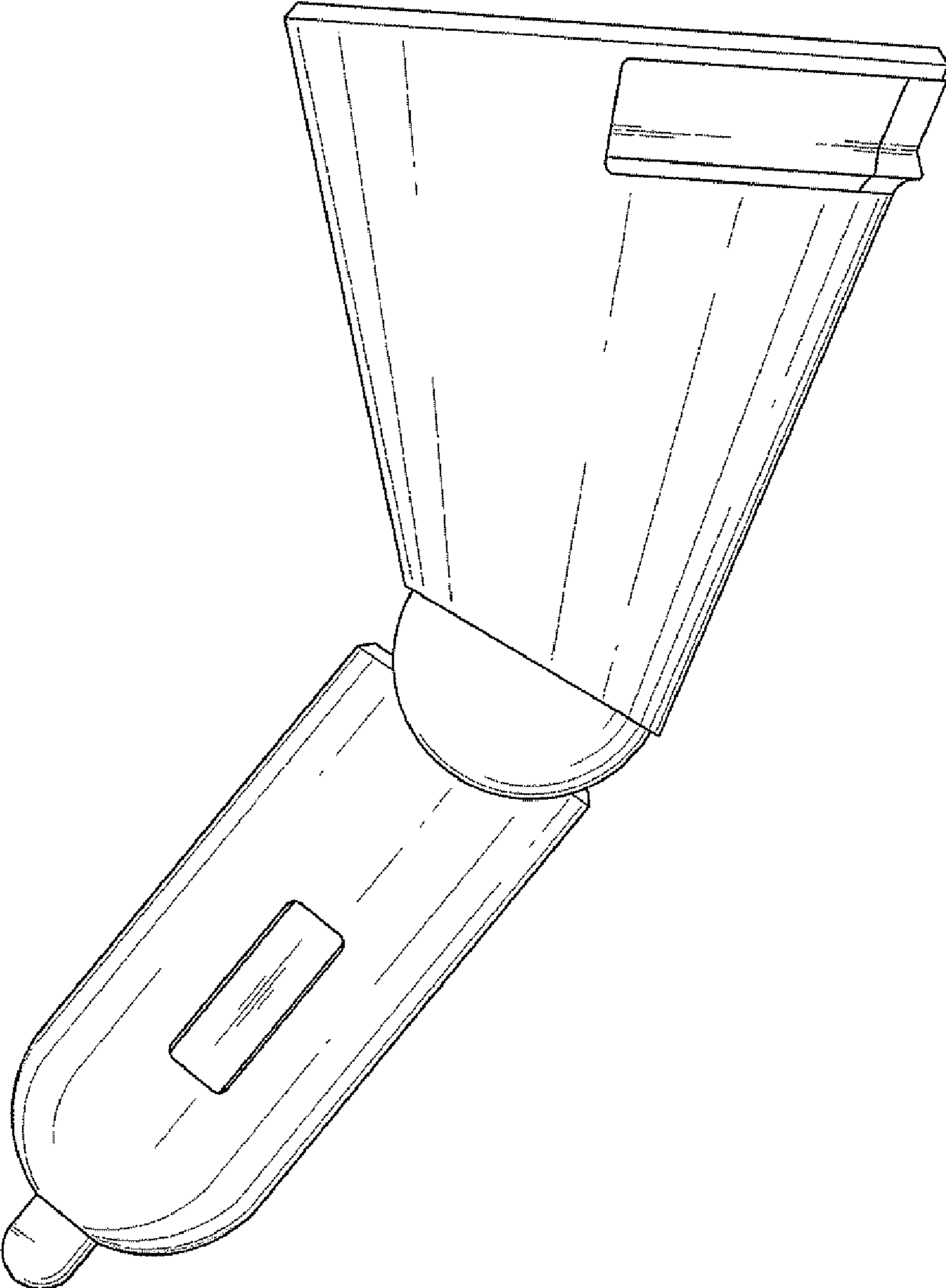

FIG.5

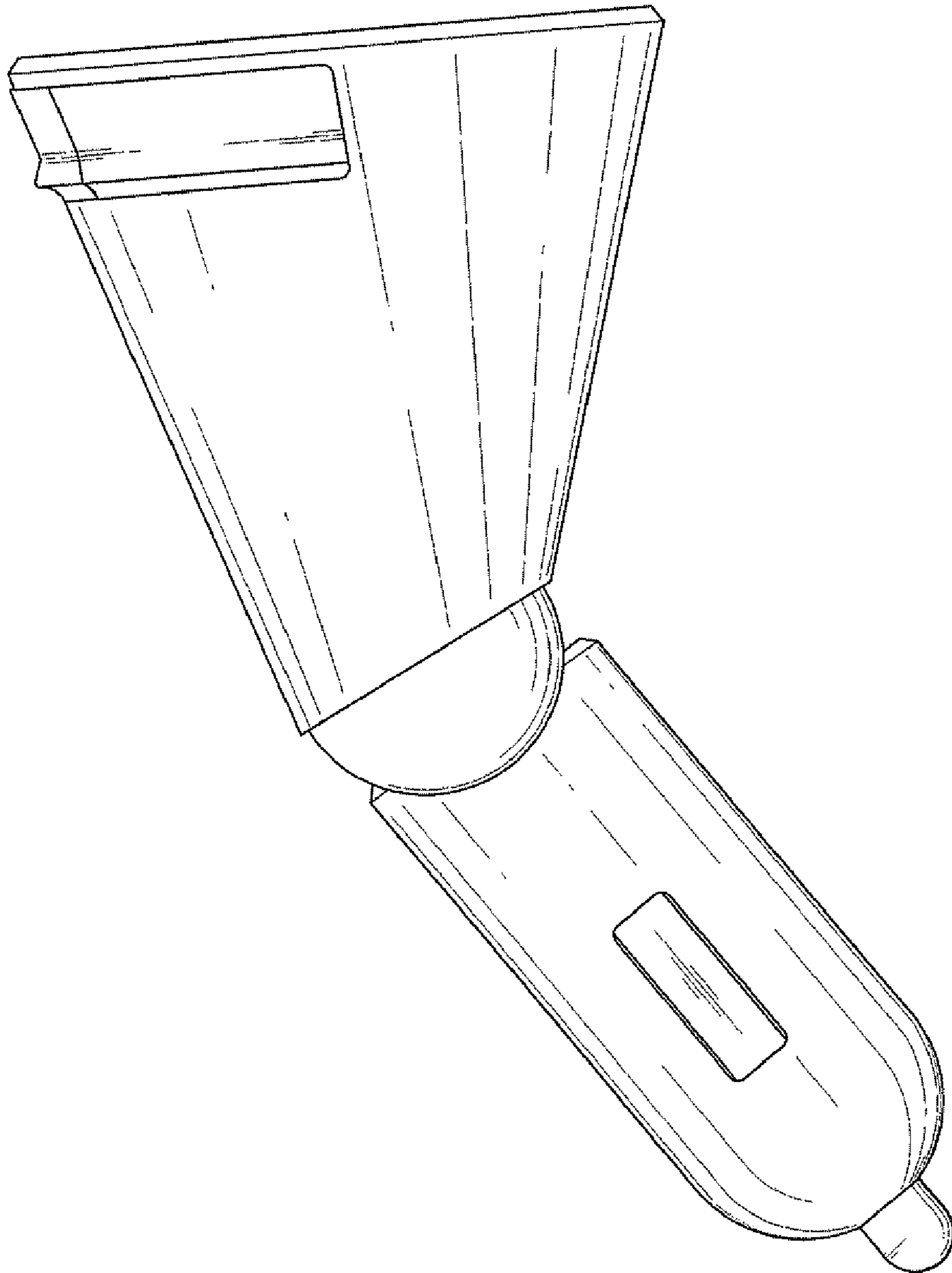

FIG.6

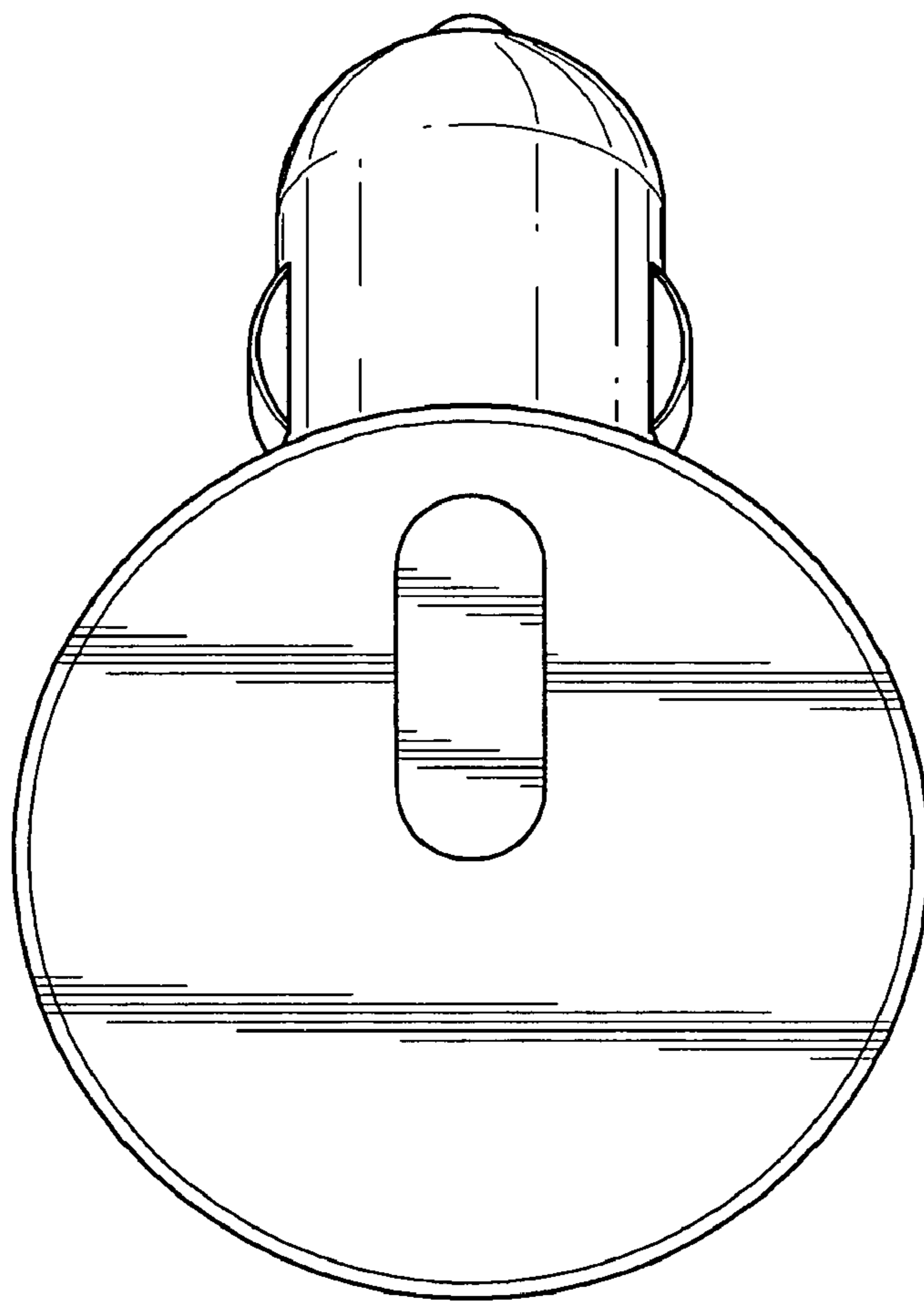

FIG.7

