



US00D619466S

(12) **United States Design Patent**
Synder

(10) **Patent No.:** **US D619,466 S**
(45) **Date of Patent:** **** Jul. 13, 2010**

(54) **BOTTLE**

(75) Inventor: **David A. Synder**, West Chicago, IL (US)

(73) Assignee: **Kranson Industries, Inc.**, St. Louis, MO (US)

(**) Term: **14 Years**

(21) Appl. No.: **29/350,451**

(22) Filed: **Nov. 17, 2009**

(51) **LOC (9) Cl.** **09-01**

(52) **U.S. Cl.** **D9/522; D9/523; D9/565; D9/571; D9/575; D9/520**

(58) **Field of Classification Search** D9/682, D9/685-687, 693-694, 516, 520, 522-523, D9/529-530, 542-543, 552, 565, 571, 575; 215/382-384; 220/660, 669, 675; D23/202, D23/204-205; D24/212, 224

See application file for complete search history.

(56) **References Cited**

U.S. PATENT DOCUMENTS

- D103,520 S * 3/1937 Smith D9/522
- D196,453 S * 10/1963 Koenigsberg D9/530 X
- D206,830 S * 1/1967 Marchant D9/542
- D228,382 S * 9/1973 Sterges D9/543
- D234,249 S * 2/1975 Holzaepfel D9/529
- D282,909 S * 3/1986 Biesecker D9/522
- D330,516 S * 10/1992 Cavazza D9/571
- D333,618 S * 3/1993 Patel et al. D9/522
- D349,056 S * 7/1994 Jaramillo D9/523
- D414,114 S * 9/1999 Mangold D9/522
- D419,455 S * 1/2000 Macauley et al. D9/575
- D429,646 S * 8/2000 Goettner D9/571 X
- D447,954 S * 9/2001 Cummings D9/530
- D481,950 S * 11/2003 Bakic D9/522 X
- D513,990 S * 1/2006 Archeny D9/575 X

- D564,884 S * 3/2008 Rittman D9/522
- D583,245 S 12/2008 Lepoitevin
- D583,672 S 12/2008 Lepoitevin
- D584,155 S 1/2009 Lorio
- D584,635 S 1/2009 Montgomery
- D585,286 S 1/2009 Rosinski et al.
- D585,750 S 2/2009 Kuzma et al.
- D587,122 S 2/2009 Herstol et al.
- D589,349 S 3/2009 Prater et al.
- D590,260 S 4/2009 Prater et al.
- D590,263 S 4/2009 Matsumura et al.
- D591,157 S 4/2009 Bourne
- D591,160 S 4/2009 Windmiller
- D594,087 S * 6/2009 Campbell D23/202
- D600,564 S * 9/2009 da Barp D9/523 X
- D601,425 S * 10/2009 Miller et al. D9/529 X

* cited by examiner

Primary Examiner—Carol Rademaker

(74) *Attorney, Agent, or Firm*—H. Frederick Rusche; Husch Blackwell Sanders LLP

(57) **CLAIM**

I claim the ornamental design for a bottle, as shown and described.

DESCRIPTION

FIG. 1 is a top, front, and right side perspective view of a bottle showing my new design;

FIG. 2 is a bottom, rear, and left side perspective view thereof;

FIG. 3 is a front elevational view thereof;

FIG. 4 is a right side elevational view thereof.

FIG. 5 is a rear elevational view thereof;

FIG. 6 is a left side elevational view thereof;

FIG. 7 is a top plan view thereof; and,

FIG. 8 is a bottom plan view thereof.

1 Claim, 3 Drawing Sheets

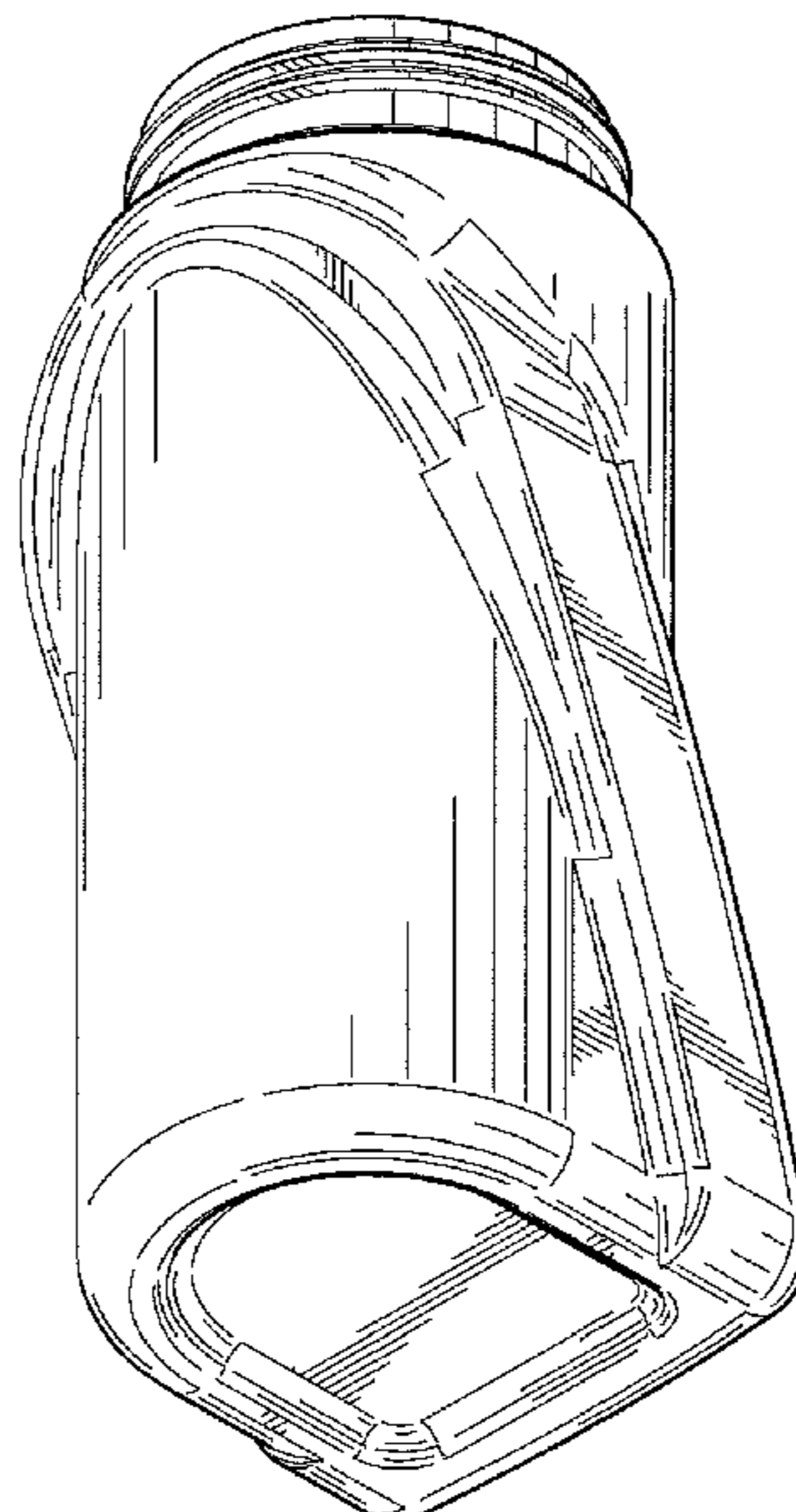
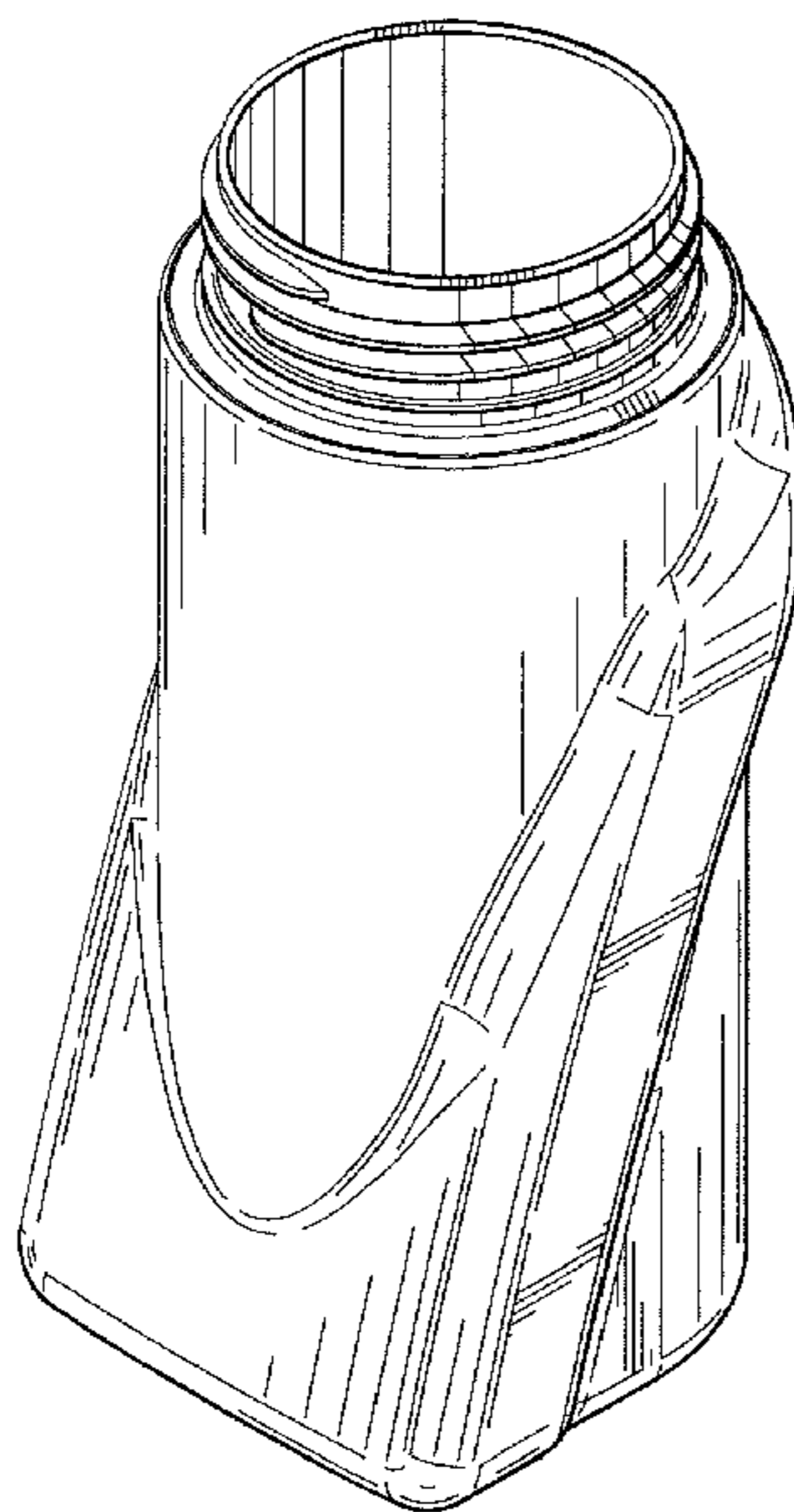

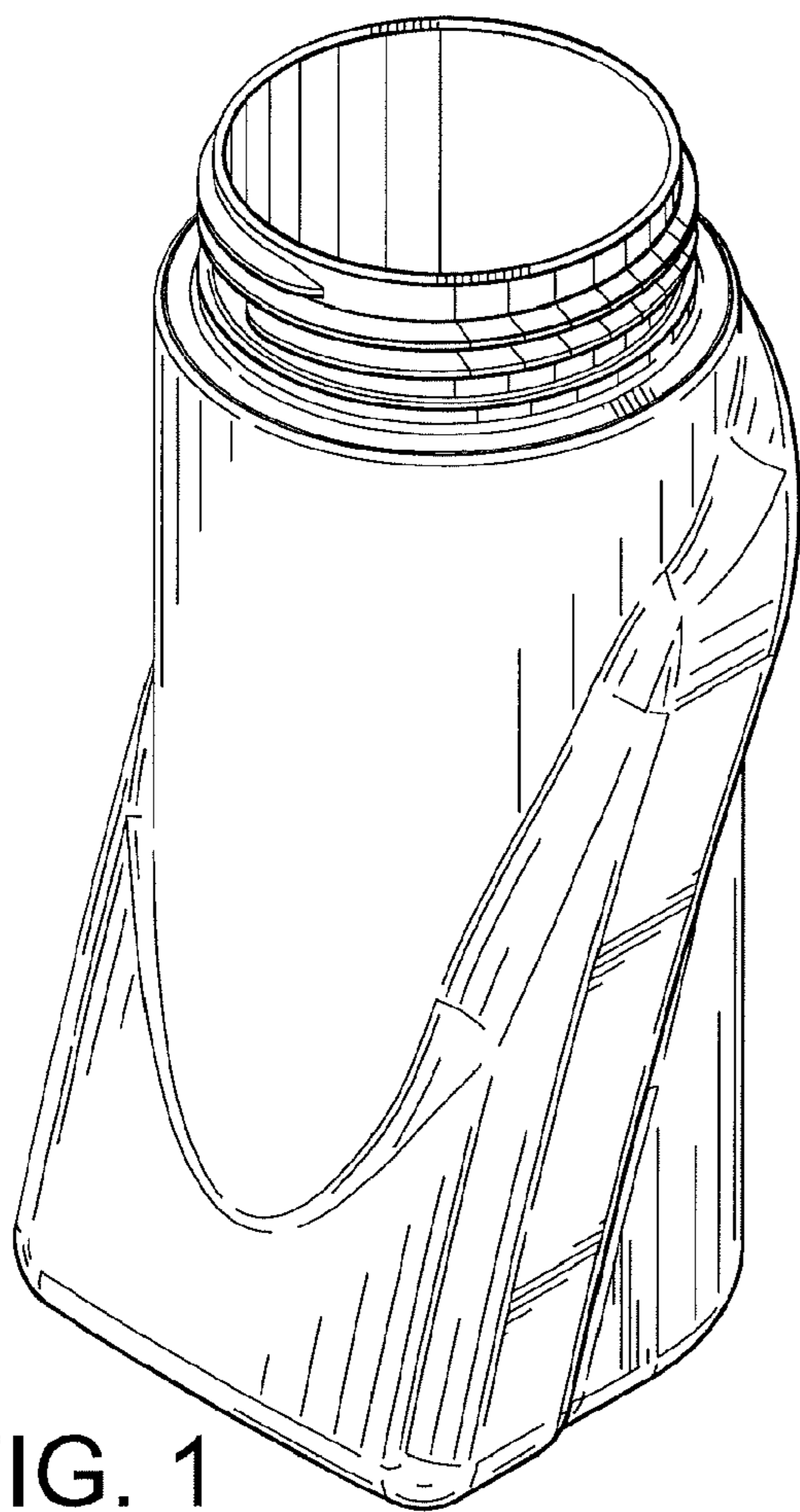

FIG. 1

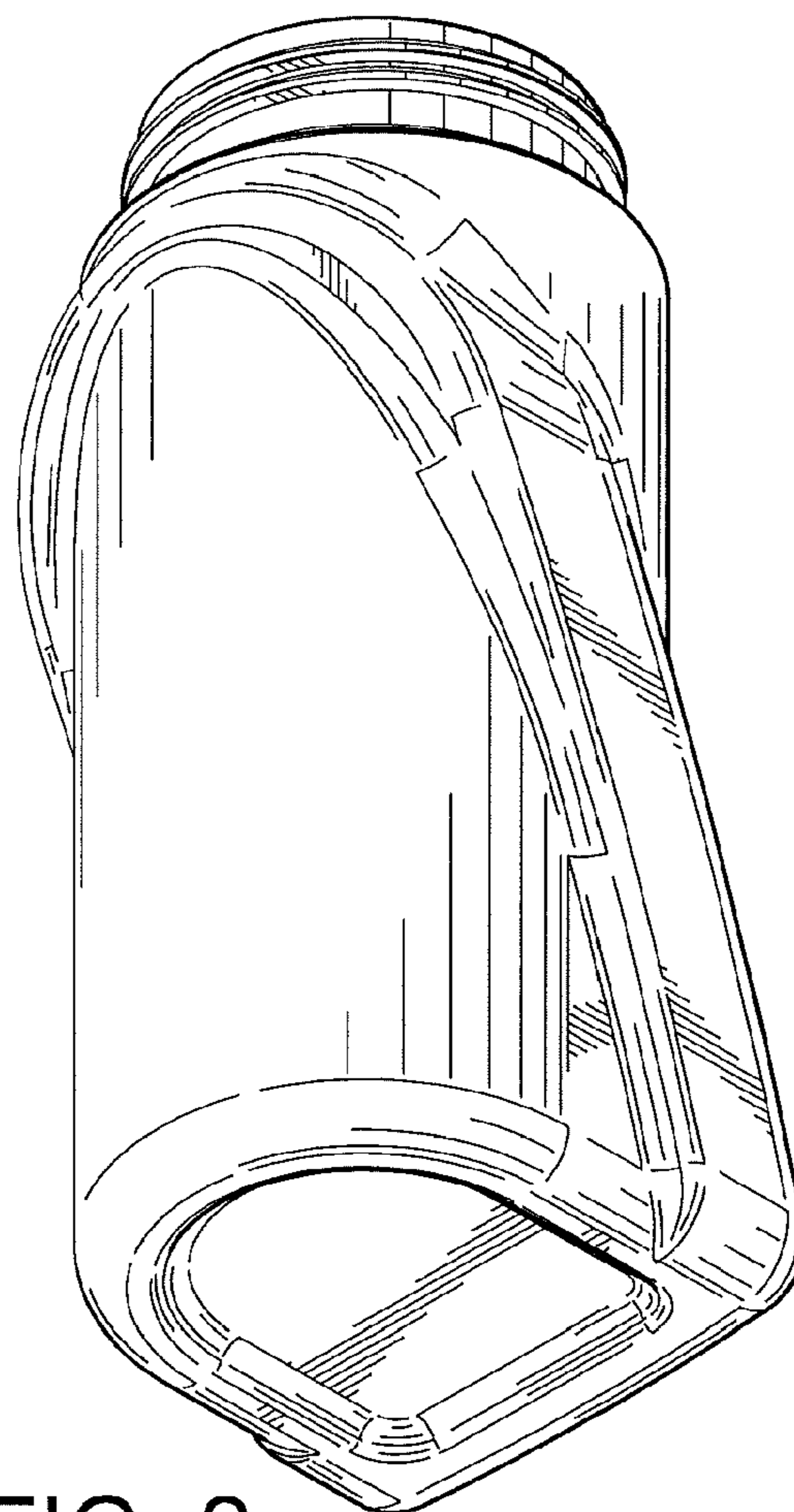

FIG. 2

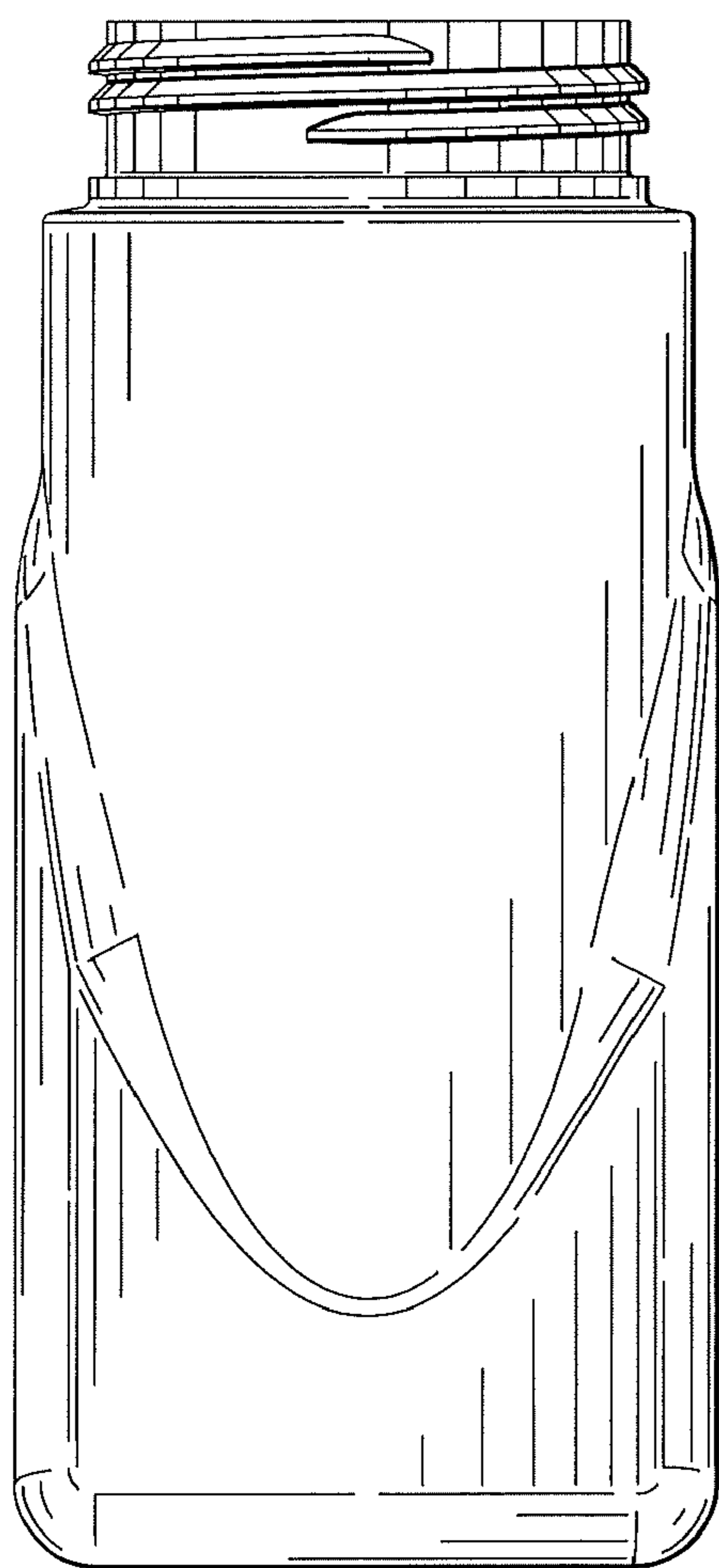

FIG. 3

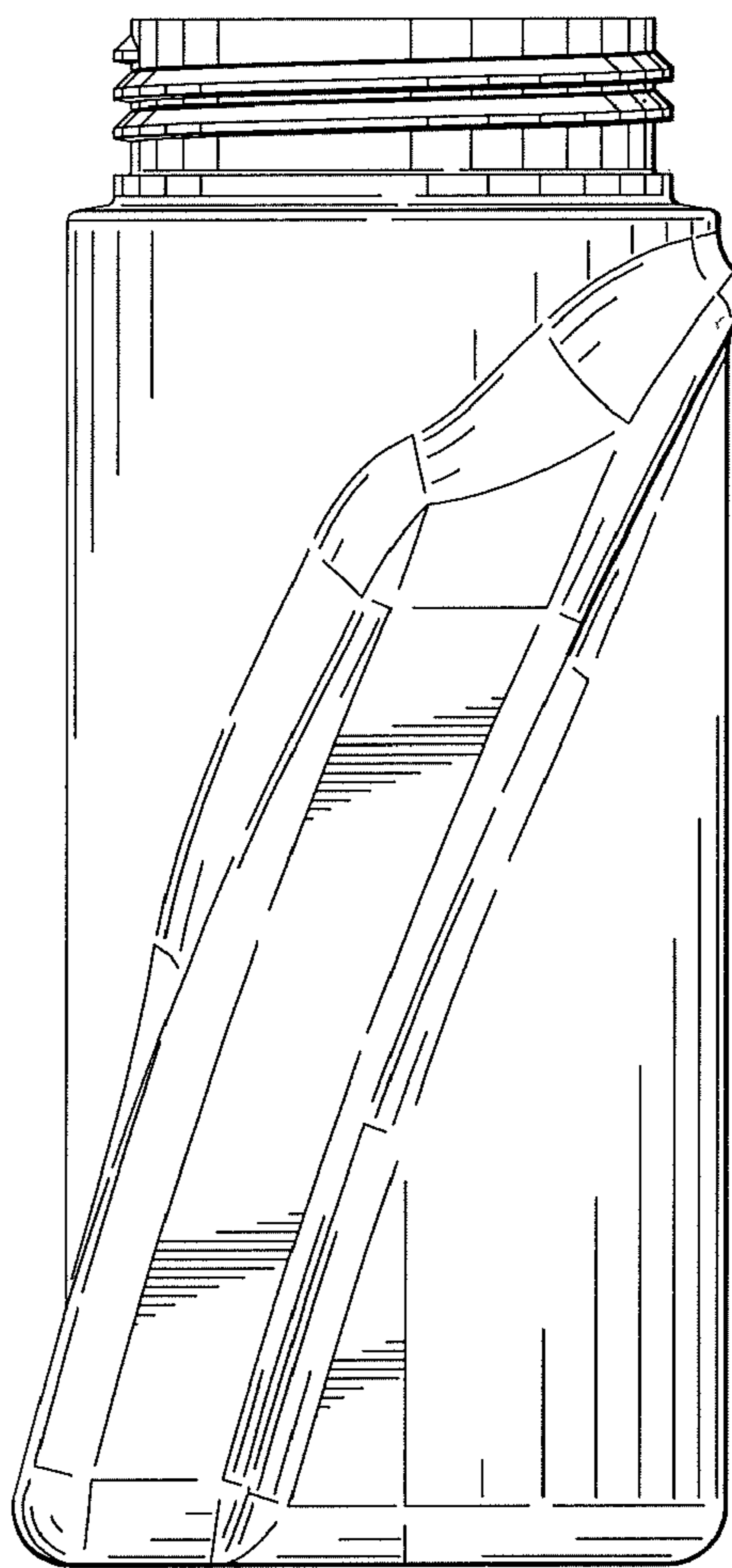

FIG. 4

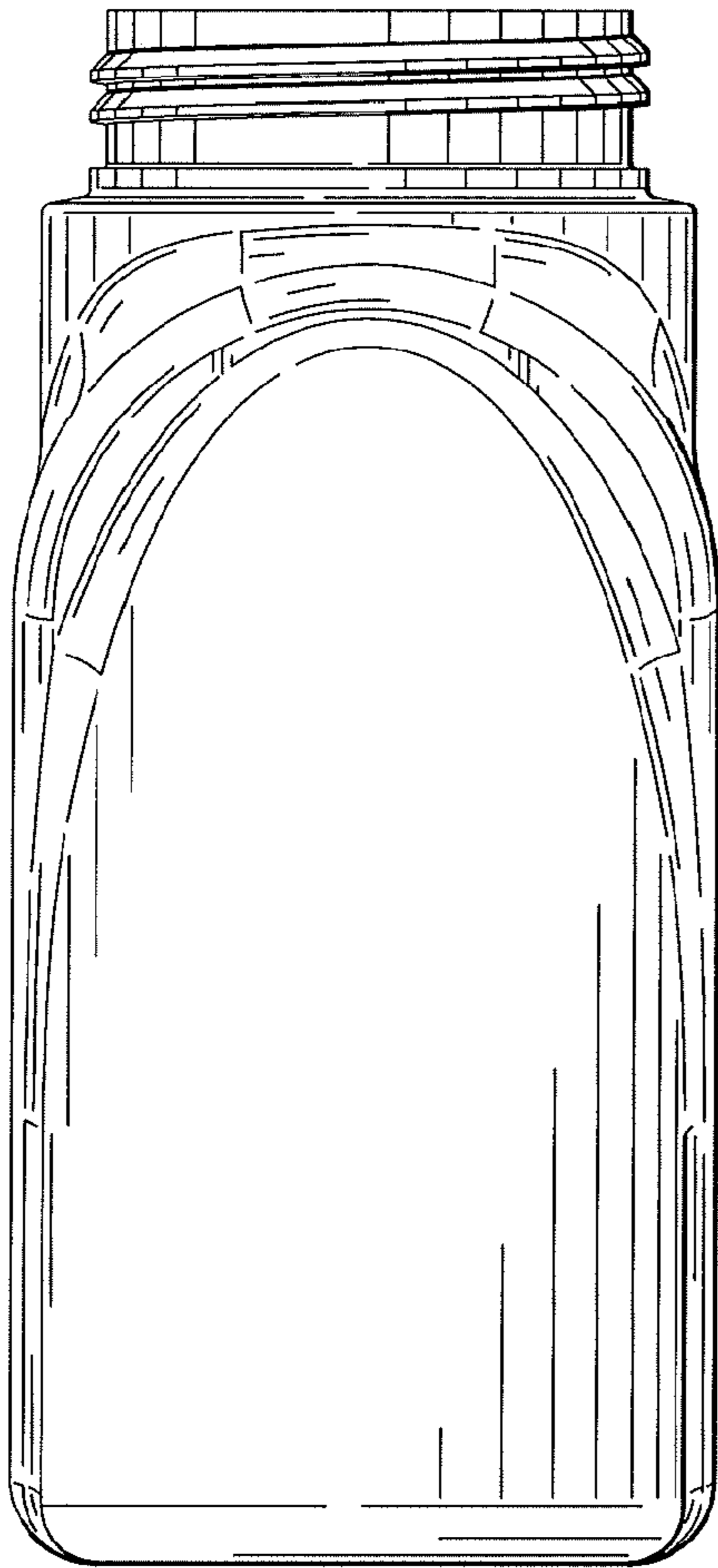

FIG. 5

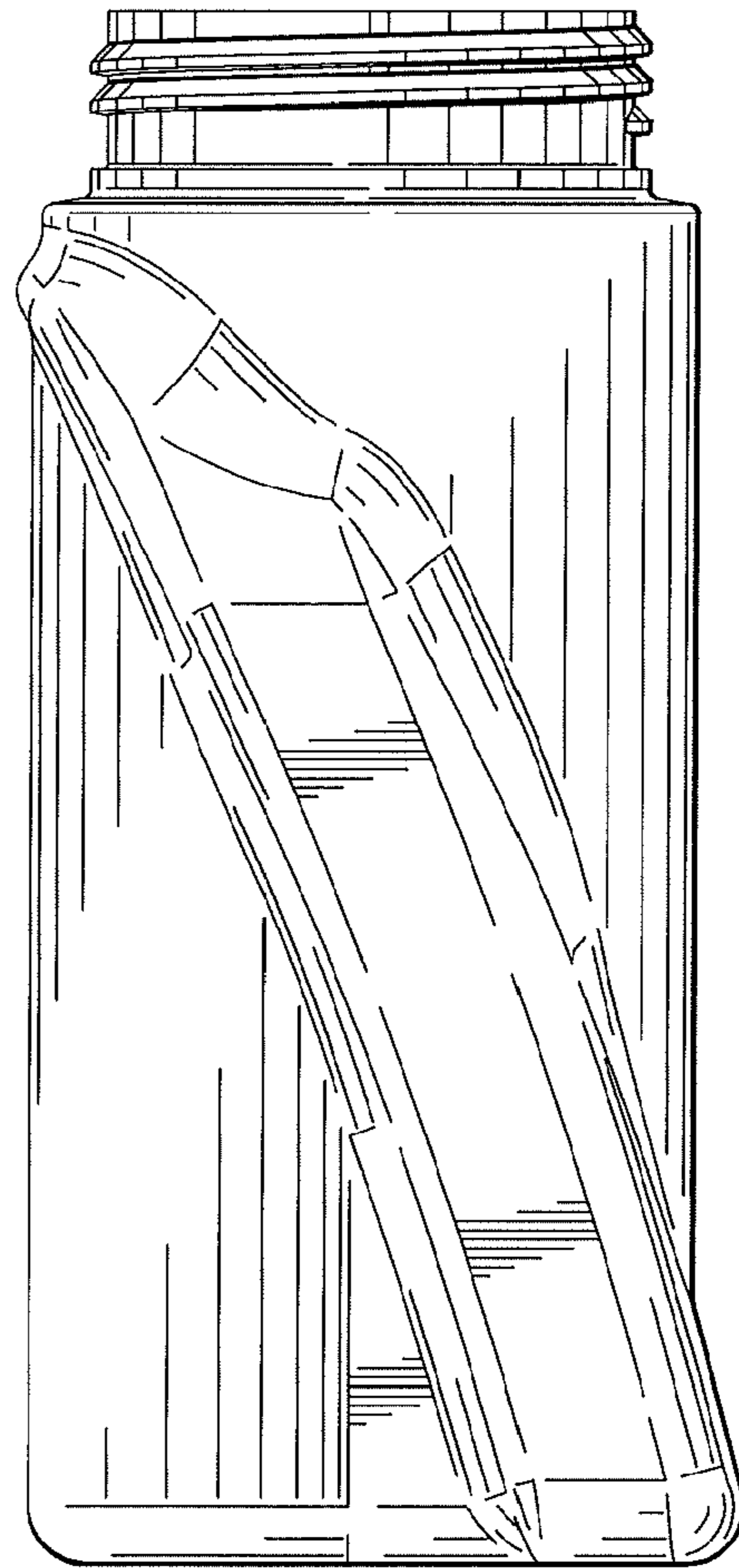

FIG. 6

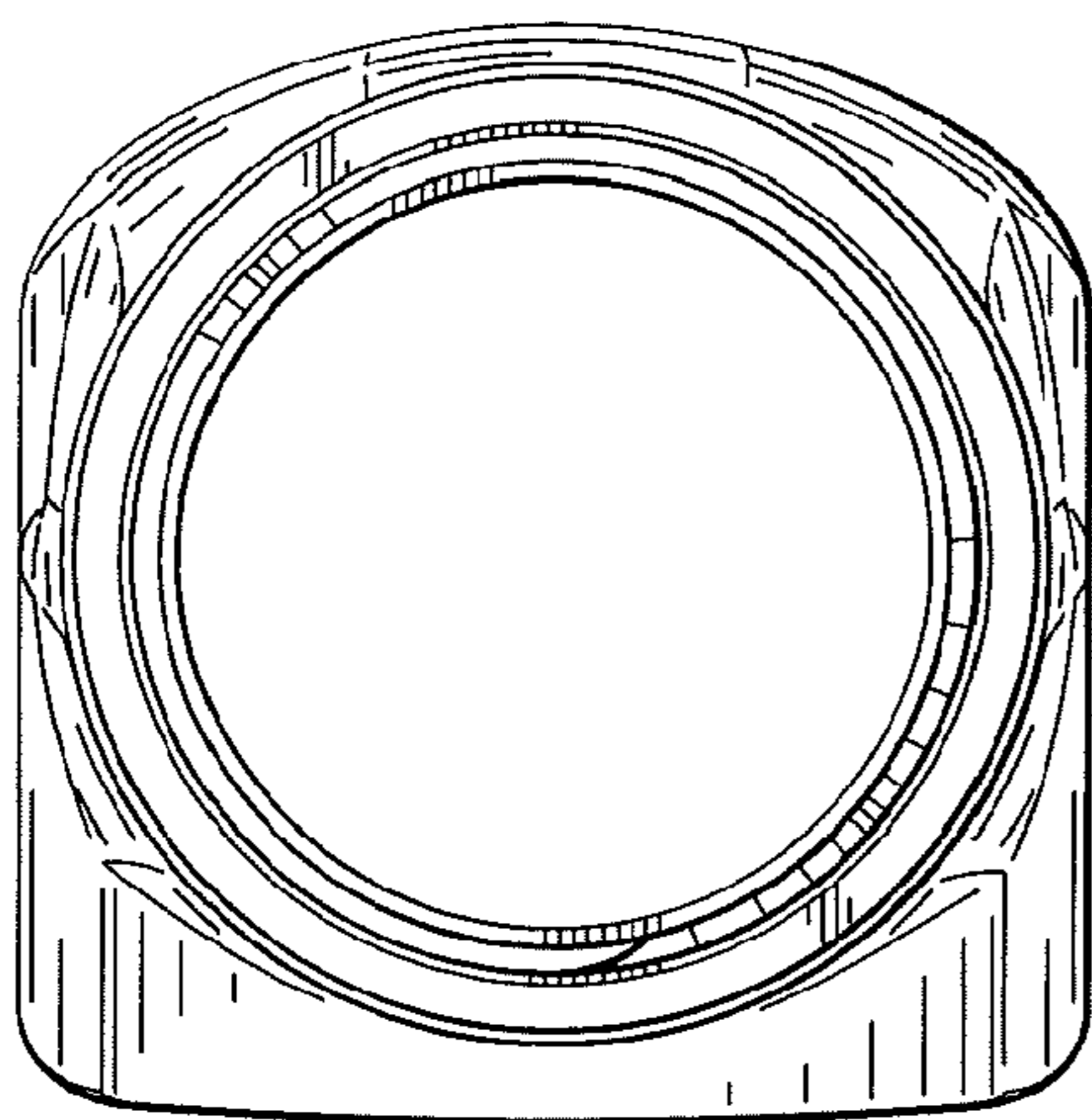

FIG. 7

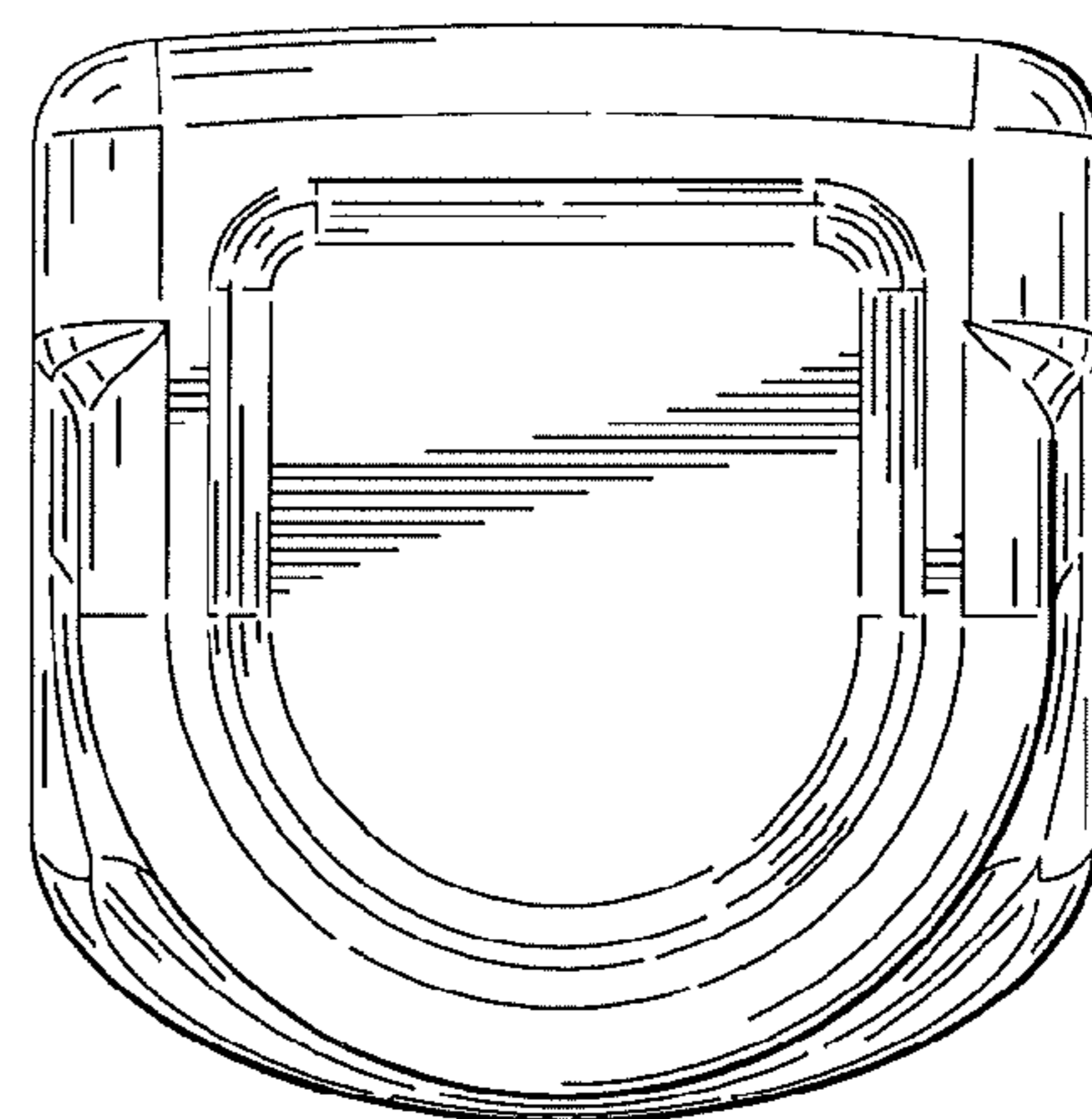

FIG. 8