



US00D619416S

(12) **United States Design Patent**
Bailey et al.

(10) **Patent No.:** **US D619,416 S**
(45) **Date of Patent:** **** Jul. 13, 2010**

(54) **CHARCOAL GRILL WITH APPEARANCE OF A FISHING BOBBER**

(76) Inventors: **Steve J. Bailey**, 412 Brady Way, Panama City, FL (US) 32408; **Paul R. Wohlford**, P.O. Box 28323, Panama City, FL (US) 32411

(**) Term: **14 Years**

(21) Appl. No.: **29/340,586**

(22) Filed: **Jul. 21, 2009**

(51) **LOC (9) Cl.** **15-05**

(52) **U.S. Cl.** **D7/402**

(58) **Field of Classification Search** D7/332,
D7/334-337, 402-405; 99/339, 449, 450,
99/482; 126/25 R, 9 R, 41 R, 50, 276, 304 A,
126/268

See application file for complete search history.

(56) **References Cited**

U.S. PATENT DOCUMENTS

4,498,452	A	*	2/1985	Schlosser et al.	126/9 R
D284,929	S	*	8/1986	Schlosser et al.	D7/332
D295,135	S	*	4/1988	Ogden	D7/334
D376,510	S	*	12/1996	Ting	D7/332
D414,374	S	*	9/1999	Ting	D7/334
D417,362	S	*	12/1999	Ting	D7/402
D420,546	S	*	2/2000	Pai	D7/332
D459,629	S	*	7/2002	Pai	D7/332
D463,707	S	*	10/2002	Bossler	D7/332
D481,256	S	*	10/2003	Bossler	D7/337
D482,561	S	*	11/2003	Yeh	D7/332
D485,116	S	*	1/2004	Kwok	D7/334
D496,821	S	*	10/2004	Pai	D7/334
D504,798	S	*	5/2005	Nipke et al.	D7/402

D505,824	S	*	6/2005	Nipke et al.	D7/334
D507,927	S	*	8/2005	Nipke et al.	D7/334
D508,364	S	*	8/2005	Nipke et al.	D7/334
D508,365	S	*	8/2005	Nipke et al.	D7/334
D511,640	S	*	11/2005	Nipke et al.	D7/337

* cited by examiner

Primary Examiner—Ruth McInroy

(74) *Attorney, Agent, or Firm*—QuickPatents, Inc.; Kevin Prince

(57) **CLAIM**

We claim the ornamental design for charcoal grill with appearance of a fishing bobber, as shown and described.

DESCRIPTION

FIG. 1 is a perspective view of a charcoal grill with appearance of a fishing bobber showing my new design, the charcoal reservoir and wheel cart shown in broken lines forming no part of the claimed design;

FIG. 2 is a perspective view thereof, showing a tripod stand in broken lines;

FIG. 3 is a front elevational view thereof;

FIG. 4 is a rear elevational view thereof;

FIG. 5 is a right-side elevational view thereof, the left-side elevational view being a mirror image;

FIG. 6 is an exploded right-side elevational view thereof, the left-side being a mirror image;

FIG. 7 is a top plan view thereof; and,

FIG. 8 is a bottom plan view thereof.

The wheel cart, charcoal reservoir and tripod stand shown in broken lines form no part of the claimed design.

1 Claim, 4 Drawing Sheets

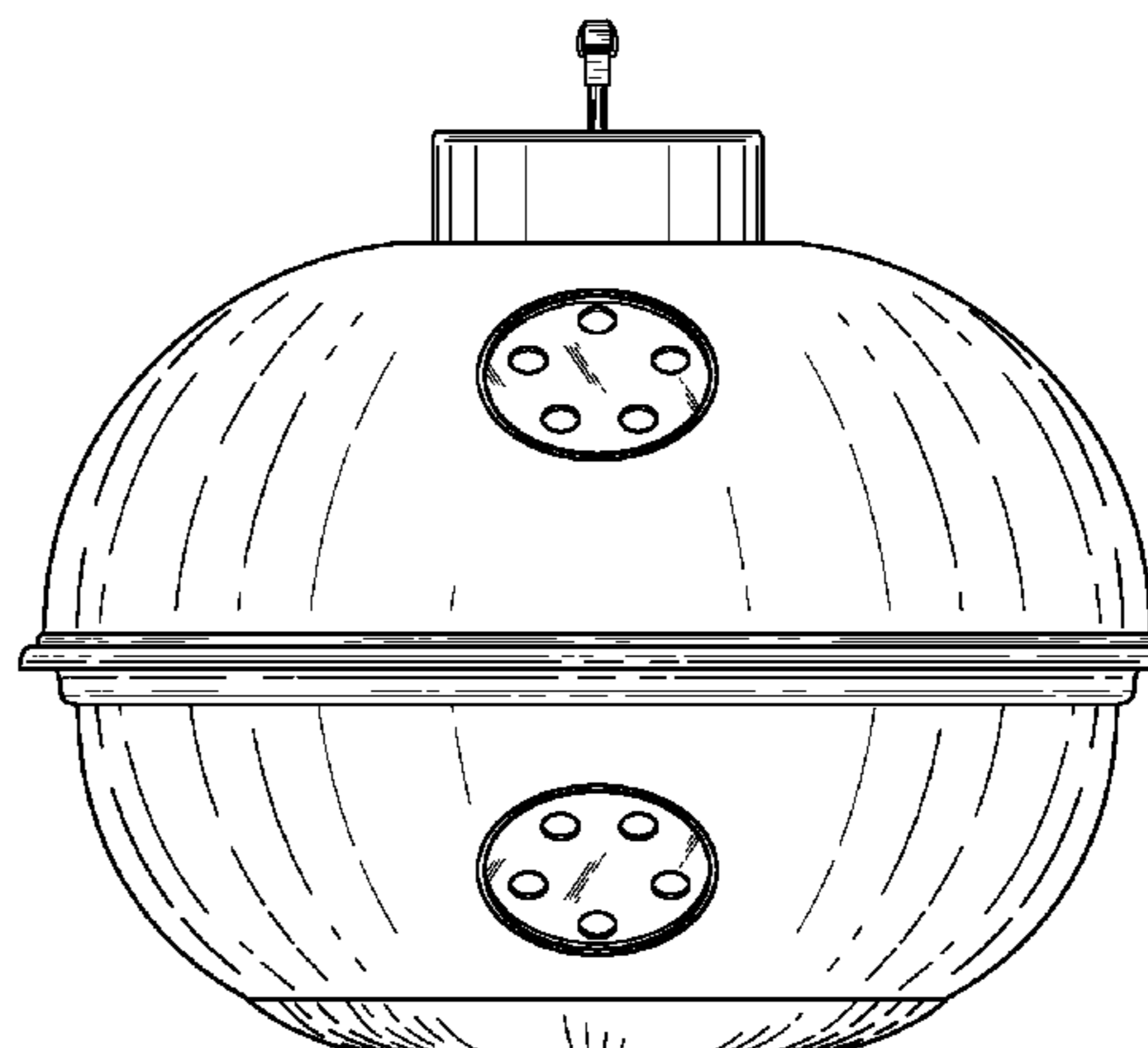
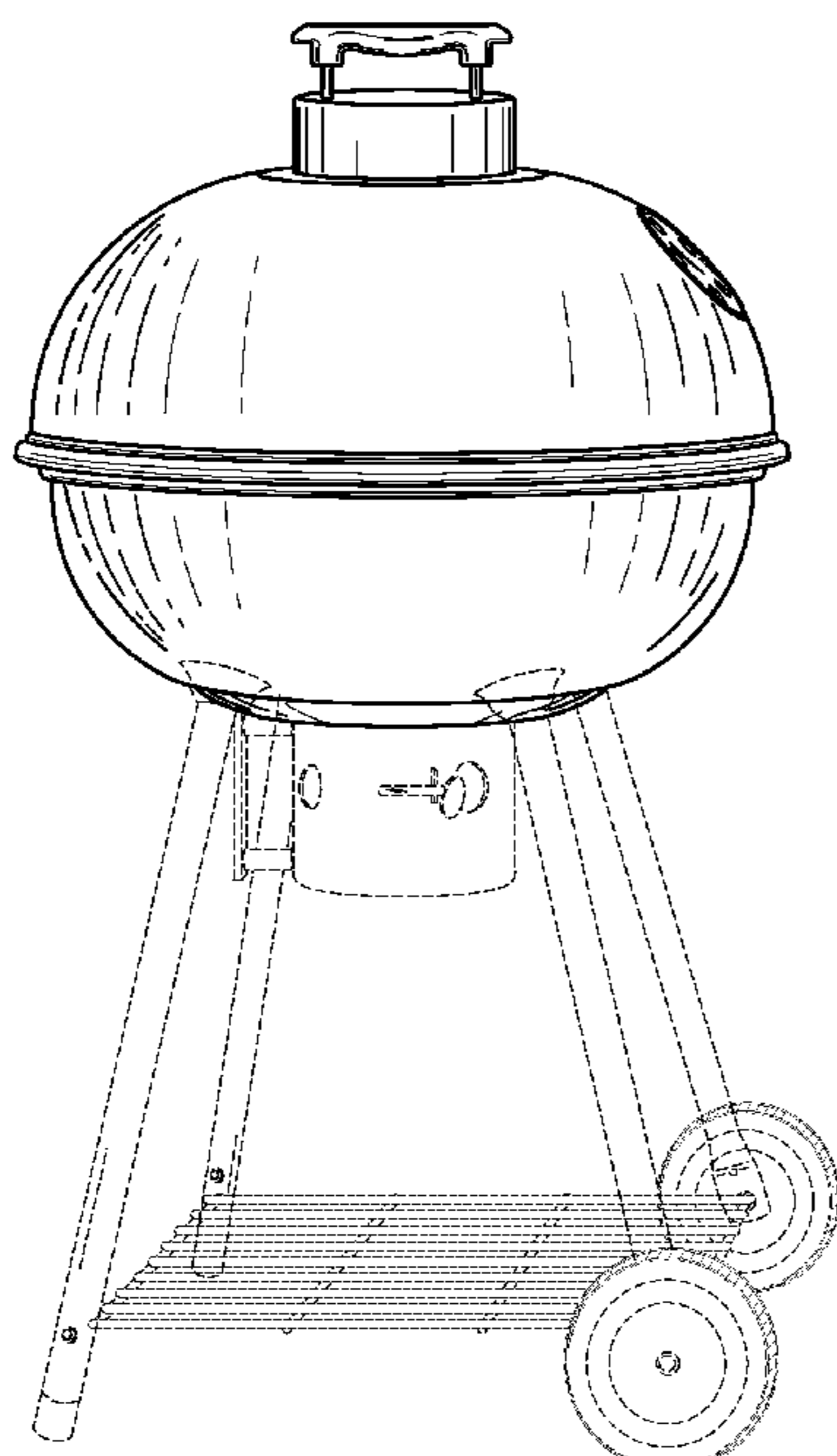

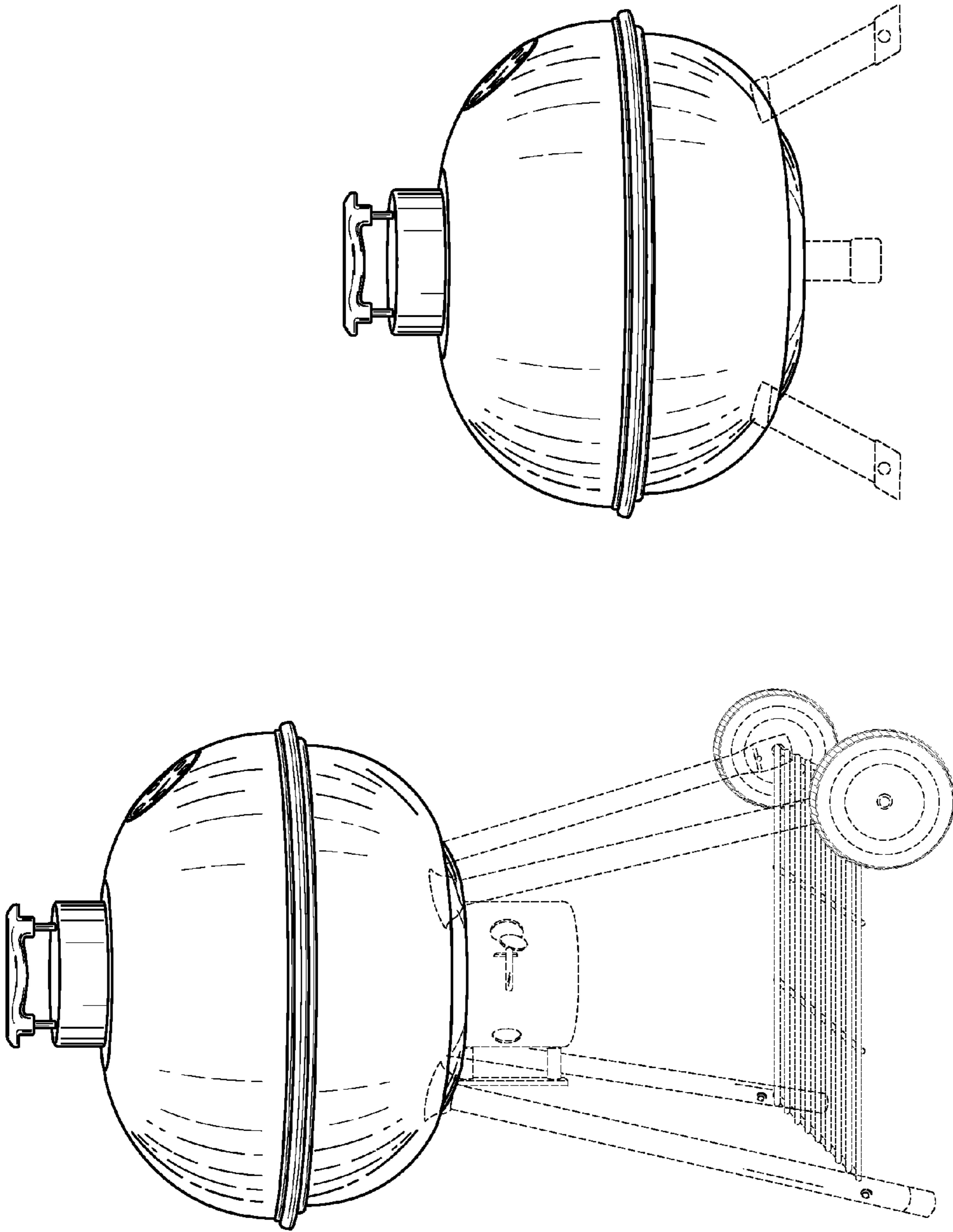

FIG. 2

FIG. 1

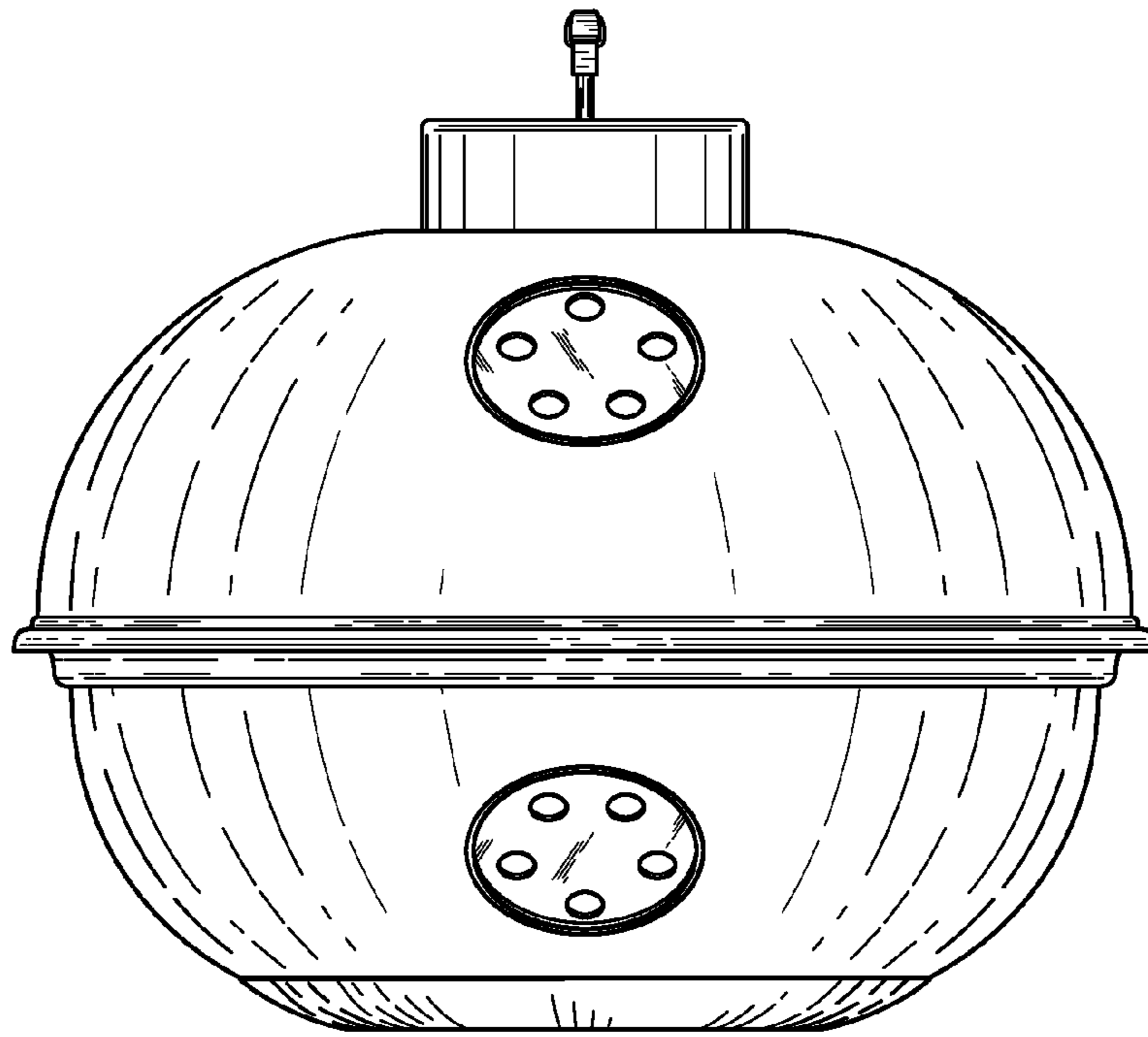

FIG. 3

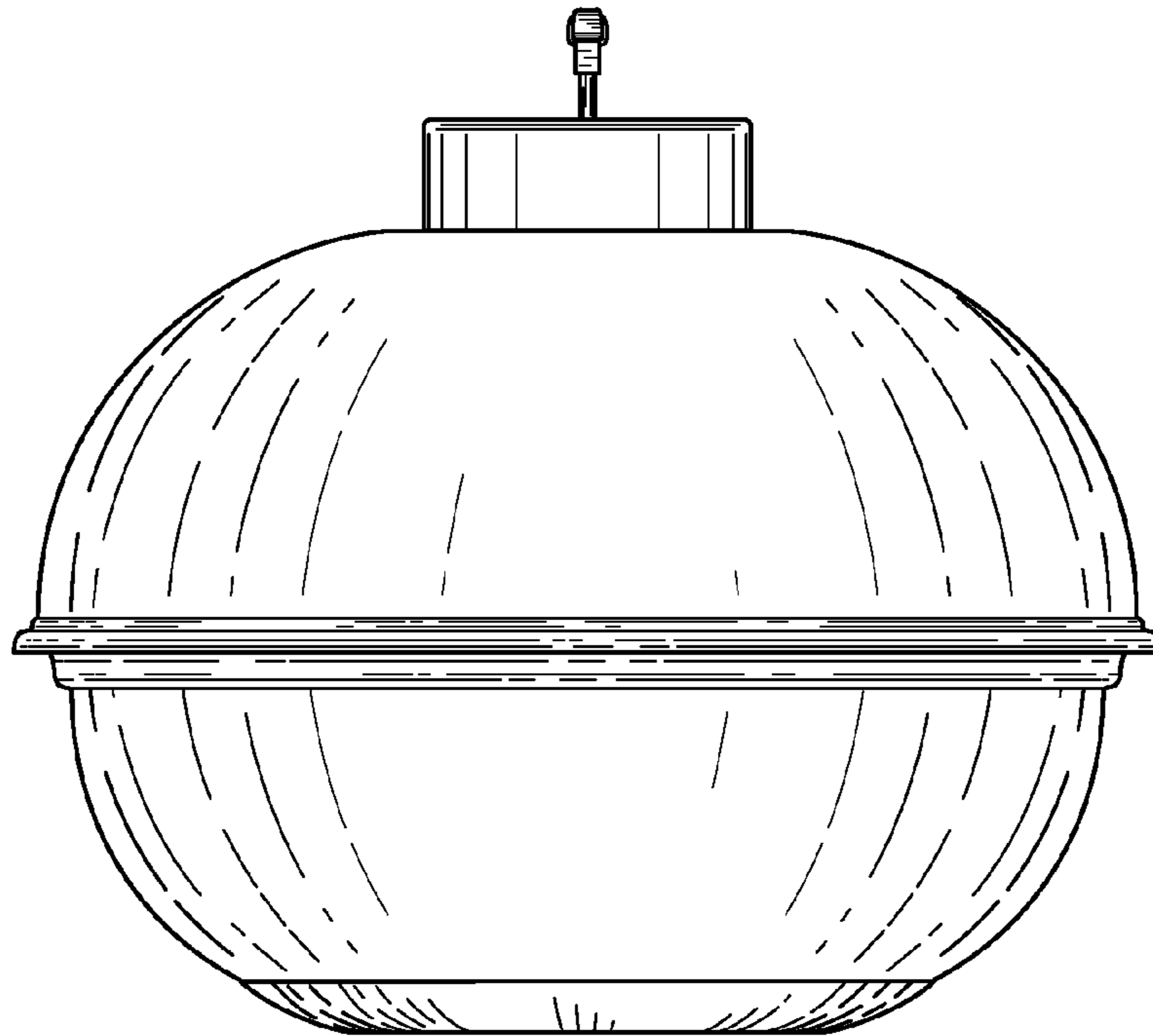

FIG. 4

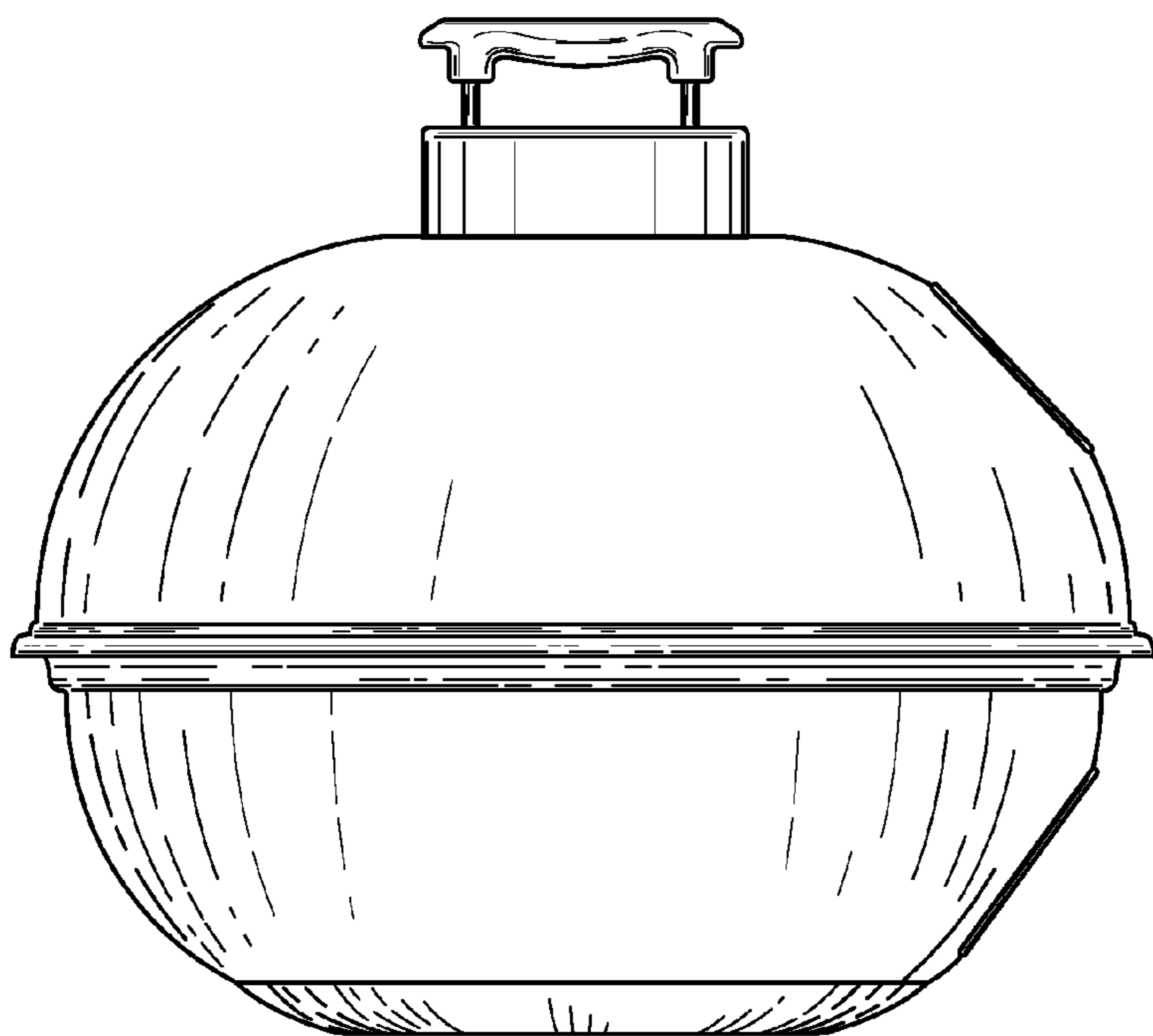

FIG. 5

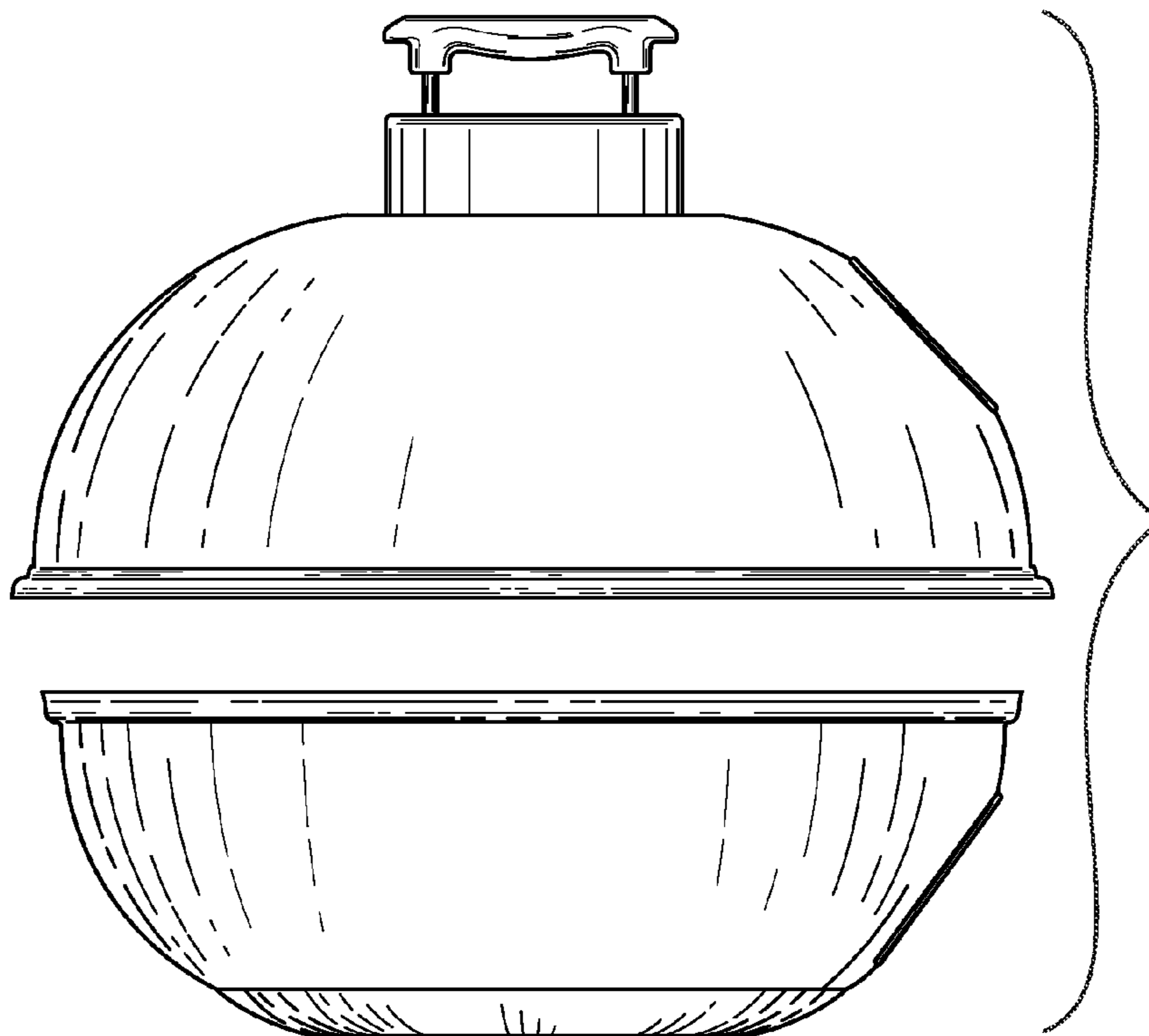

FIG. 6

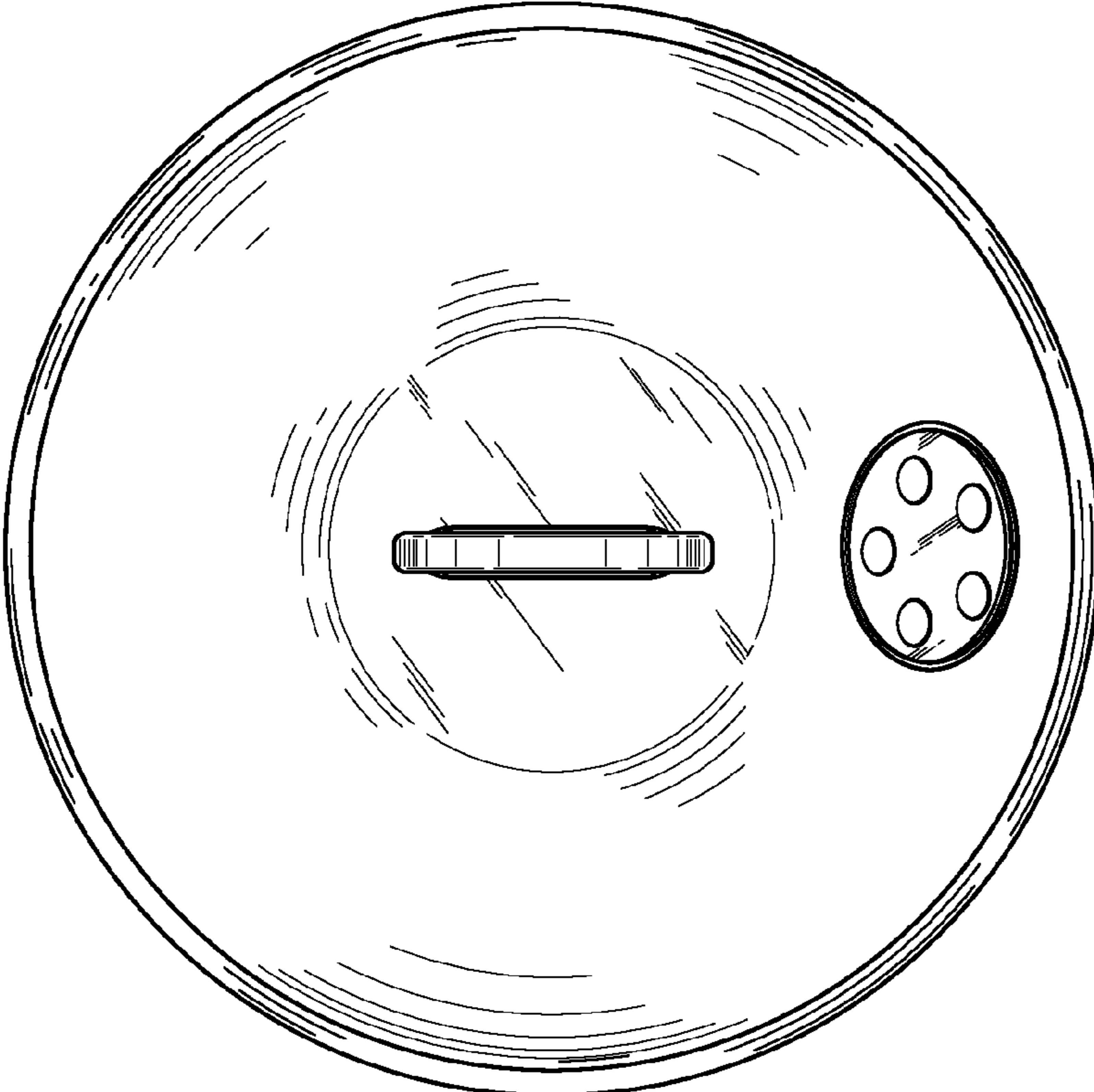

FIG. 7

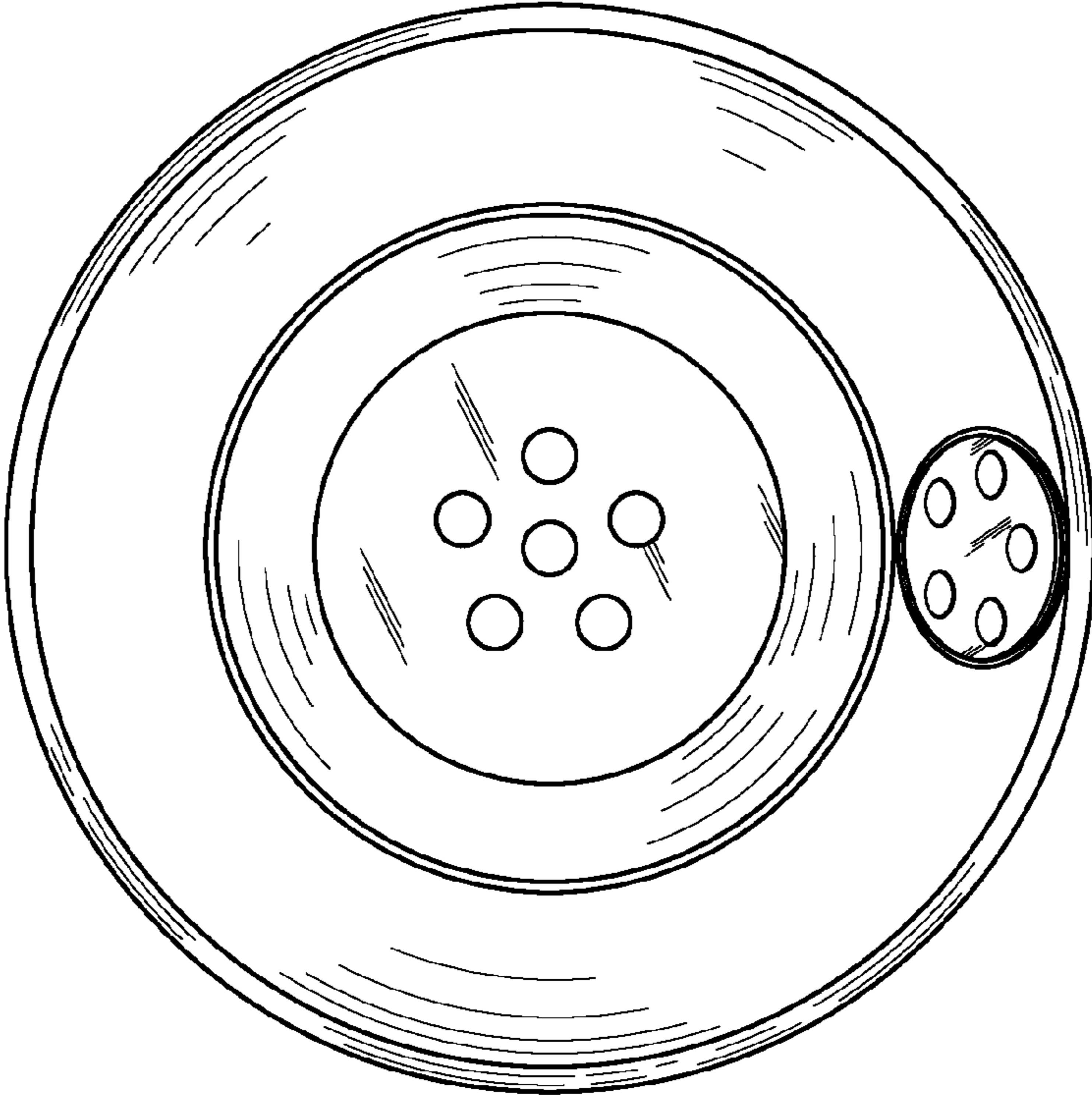

FIG. 8