



US00D619406S

(12) **United States Design Patent**
Nielsen

(10) **Patent No.:** **US D619,406 S**
(45) **Date of Patent:** **** Jul. 13, 2010**

(54) **STORAGE APPARATUS FOR MULTIMEDIA ITEMS**

D521,793 S * 5/2006 Lau D6/630
D528,341 S * 9/2006 Lau D6/630
D610,371 S * 2/2010 Nielsen D6/457

(75) Inventor: **Britta Claire Nielsen**, Seattle, WA (US)

* cited by examiner

(73) Assignee: **Slam Brands, Inc.**, Redmond, WA (US)

Primary Examiner—Elizabeth A Albert
Assistant Examiner—Kelley A Donnelly

(**) Term: **14 Years**

(74) *Attorney, Agent, or Firm*—Turocy & Watson, LLP;
Thomas E. Watson

(21) Appl. No.: **29/358,317**

(22) Filed: **Mar. 25, 2010**

(57) **CLAIM**

(51) **LOC (9) Cl.** **06-04**

An ornamental design for the storage apparatus for multimedia items, as shown and described.

(52) **U.S. Cl.** **D6/629**

(58) **Field of Classification Search** D6/629–630,
D6/396, 407, 409–416, 449, 462–465; 108/29,
108/31, 59–60; 211/34, 36–37, 40, 41.12,
211/42

DESCRIPTION

See application file for complete search history.

FIG. 1 is a first perspective view of a design for the storage apparatus for multimedia items;

FIG. 2 is a second perspective view of the design therefor;

FIG. 3 is a first side end view of the design therefor, which is mirrored on the opposite side end view;

FIG. 4 is a front view of the design therefor;

FIG. 5 is a rear view of the design therefor;

FIG. 6 is a top plan view of the design therefor; and,

FIG. 7 is a bottom plan view of the design therefor.

The dashed lines in the drawings are shown for environmental purposes and form no part of the claimed design.

(56) **References Cited**

U.S. PATENT DOCUMENTS

4,345,802 A *	8/1982	Sorensen	312/42
D360,329 S *	7/1995	Chu	D6/629
D405,309 S *	2/1999	Mok	D6/630
D409,865 S *	5/1999	West	D6/509
D433,264 S *	11/2000	Lindeqvist et al.	D6/631
D450,971 S *	11/2001	Lee	D6/630
D452,389 S *	12/2001	Scala et al.	D6/408
D458,504 S *	6/2002	Liu	D6/630

1 Claim, 6 Drawing Sheets

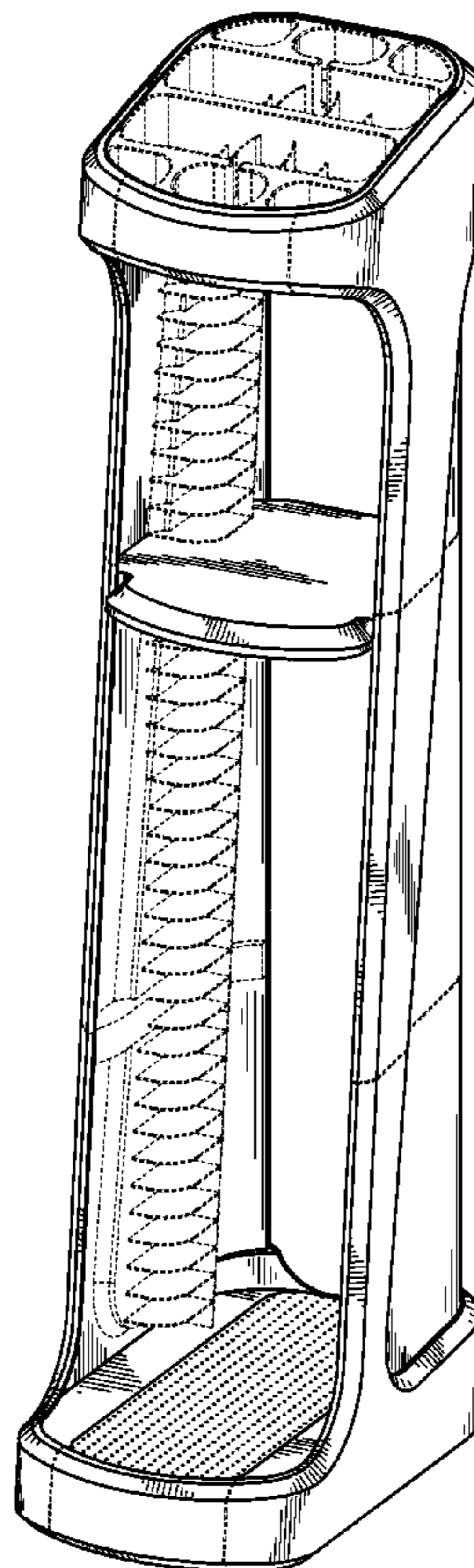

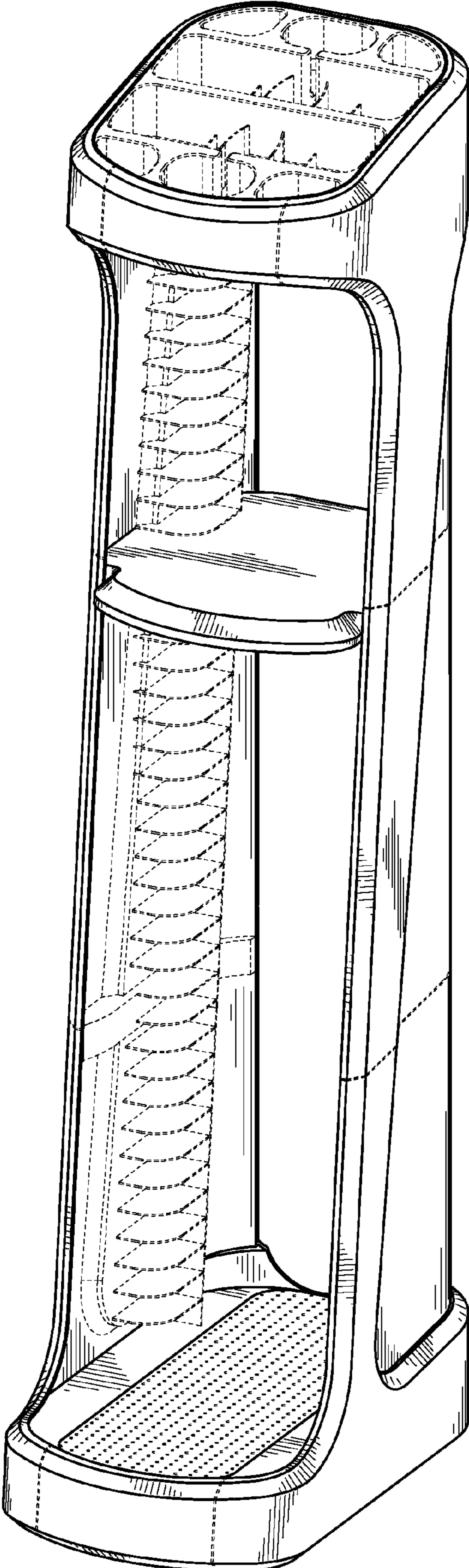

Fig. 1

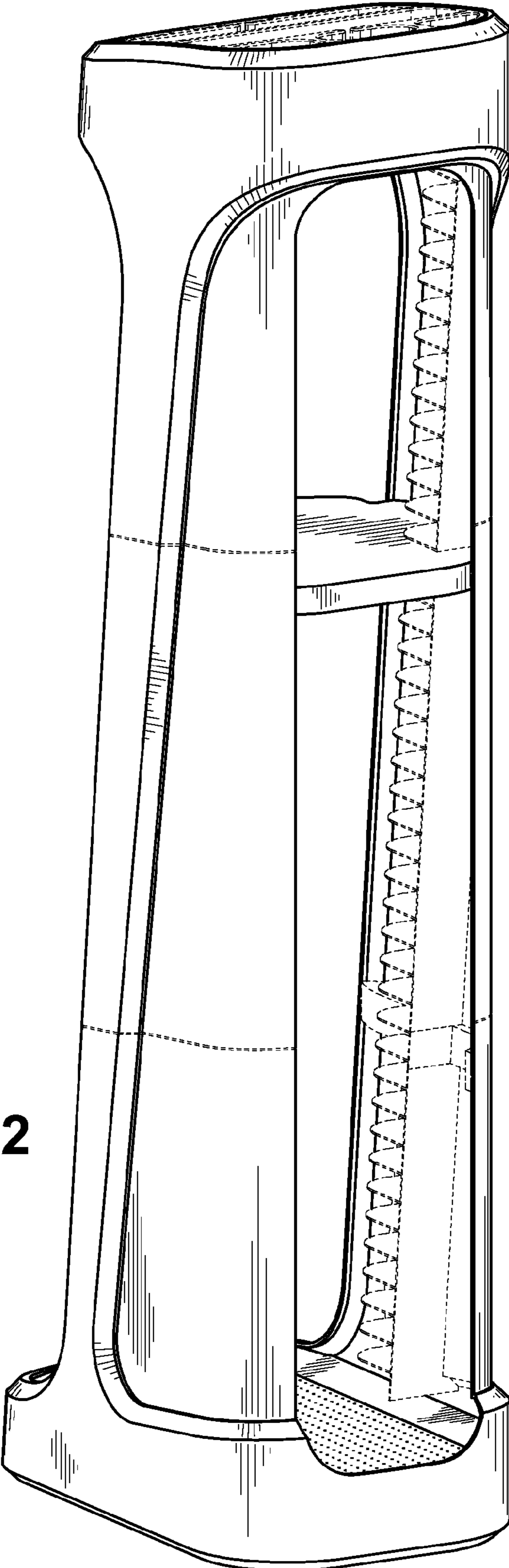

Fig. 2

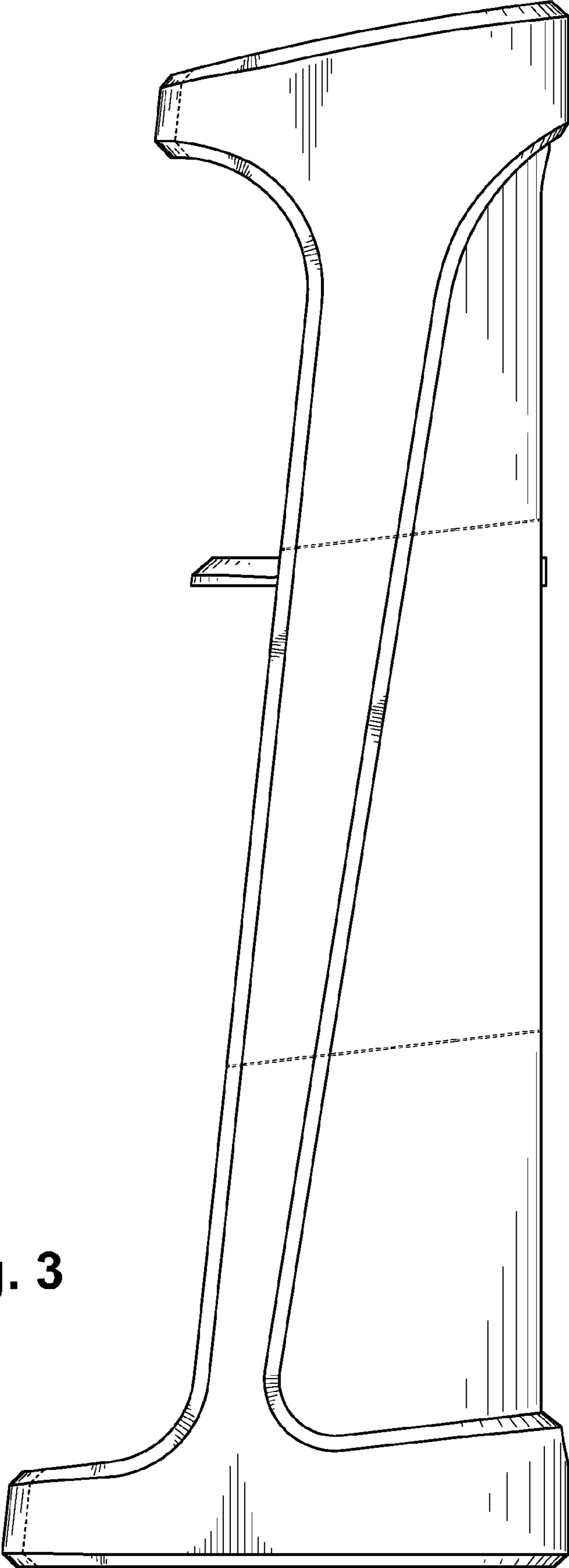

Fig. 3

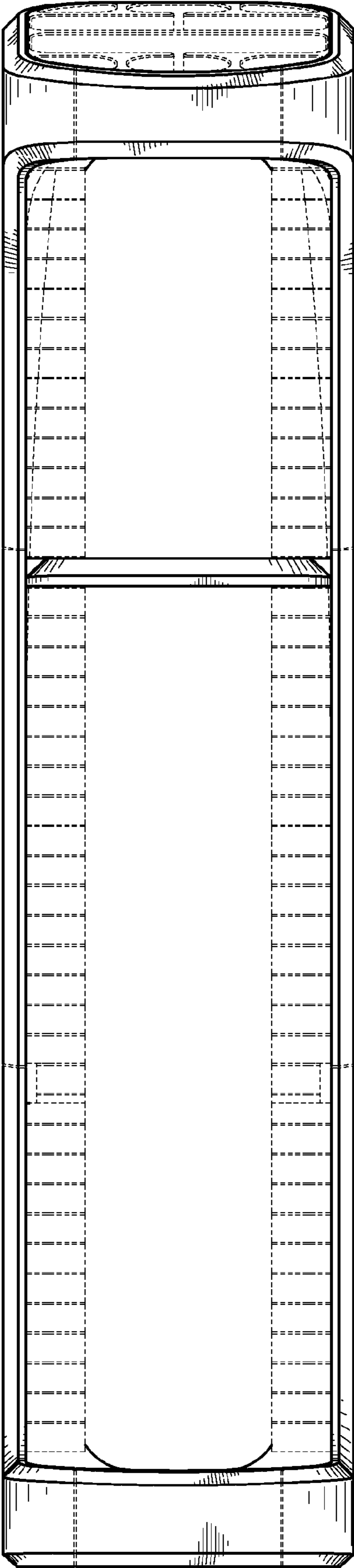

Fig. 4

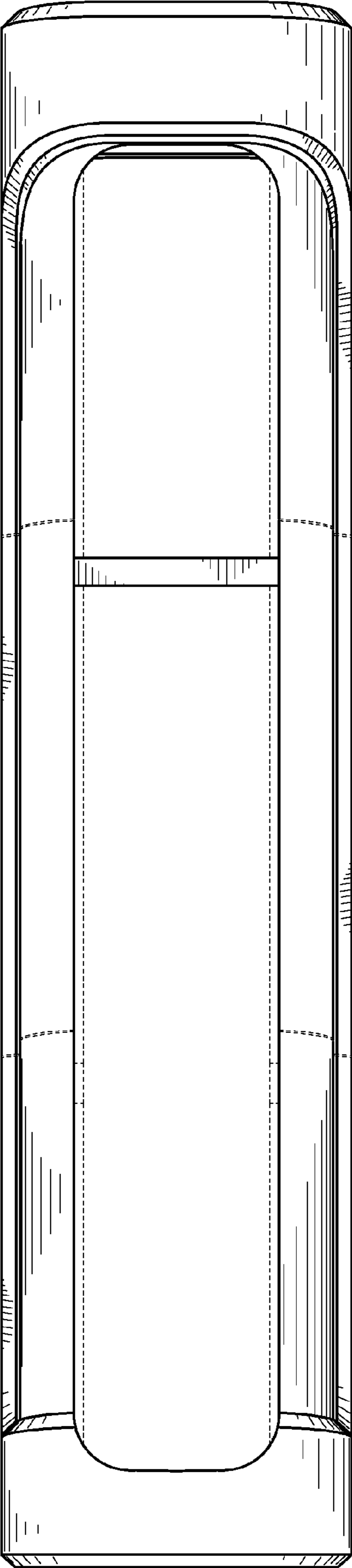

Fig. 5

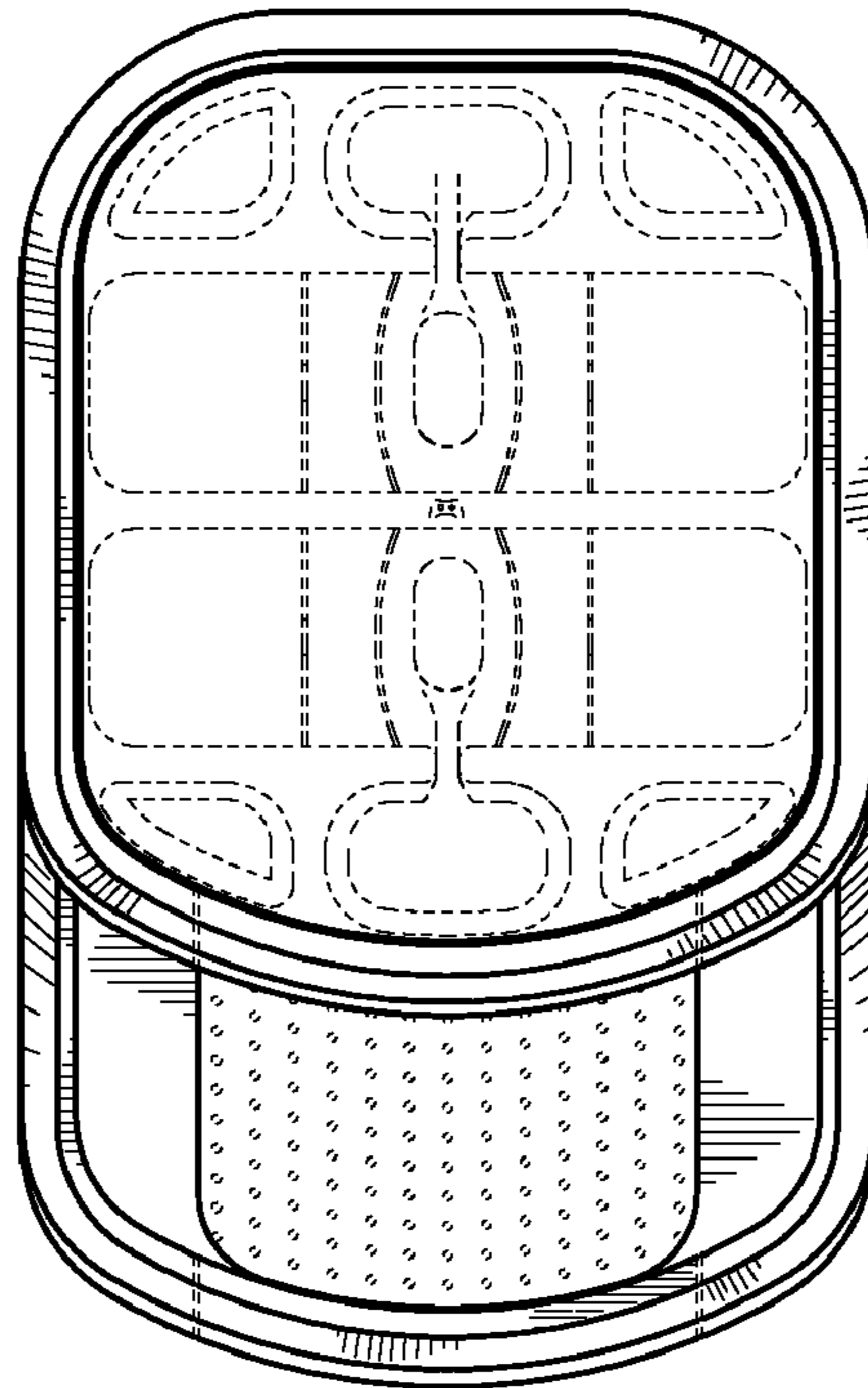

Fig. 6

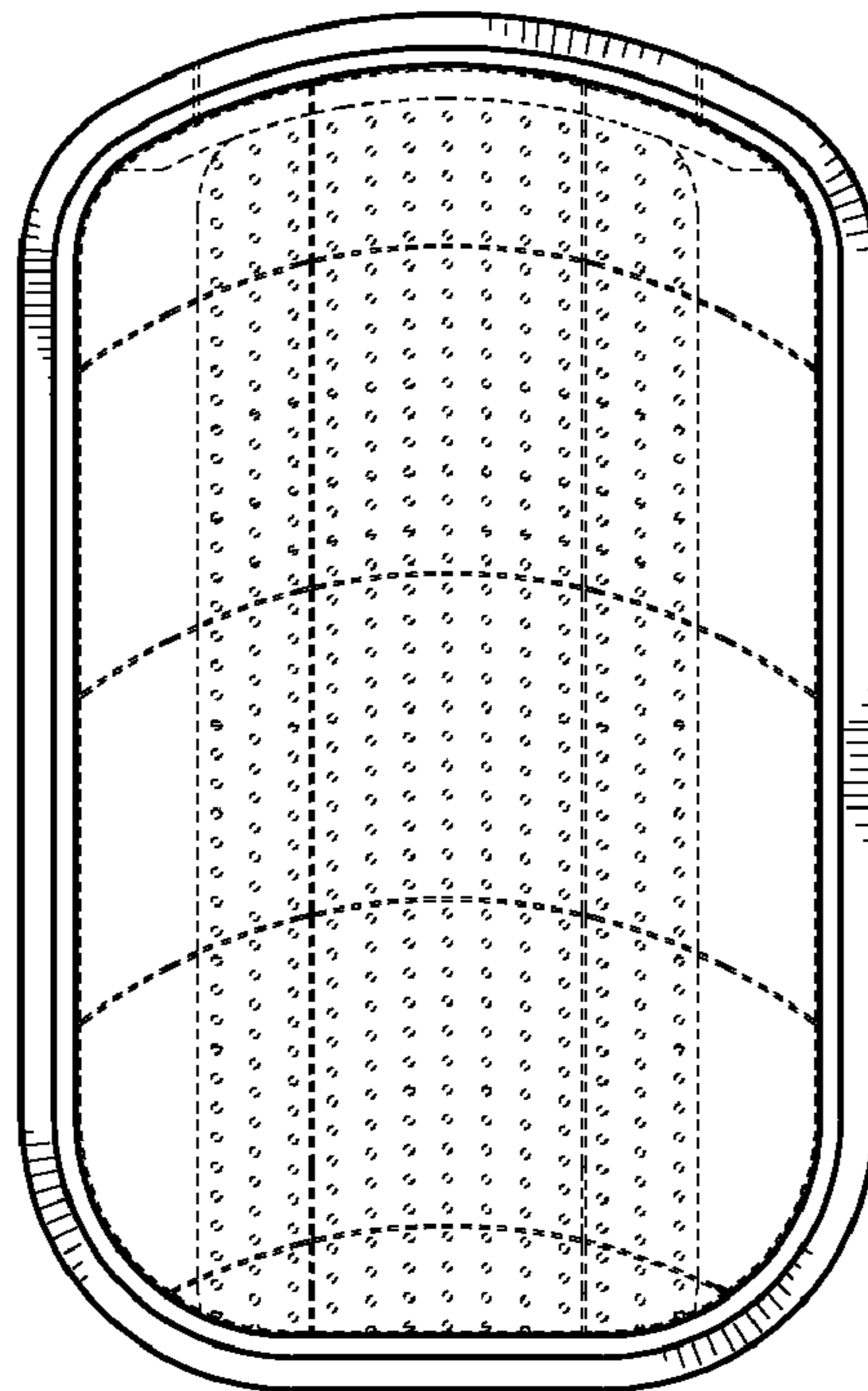

Fig. 7