



US00D619402S

(12) **United States Design Patent**
Sternlight et al.

(10) **Patent No.:** **US D619,402 S**
(45) **Date of Patent:** **** Jul. 13, 2010**

(54) **TRAVEL PILLOW**

(76) Inventors: **David Bret Sternlight**, 22339 Hart St.,
Canoga Park, CA (US) 91303; **Kyna**
Rose Sternlight, 22339 Hart St., Canoga
Park, CA (US) 91303

(**) Term: **14 Years**

(21) Appl. No.: **29/353,886**

(22) Filed: **Jan. 15, 2010**

(51) **LOC (9) Cl.** **06-09**

(52) **U.S. Cl.** **D6/601**

(58) **Field of Classification Search** D6/595-601,
D6/604, 605; 5/630, 633, 636-638, 640,
5/644, 652-654, 655.3, 655.6, 655.9, 656,
5/657, 657.5; D21/803, 804

See application file for complete search history.

(56) **References Cited**

U.S. PATENT DOCUMENTS

1,468,072 A * 9/1923 Ogle 5/654
6,230,348 B1 * 5/2001 Patrikakis 5/636
D445,624 S * 7/2001 Futagami D6/604
D481,247 S * 10/2003 Roberts et al. D6/604
D582,713 S * 12/2008 Baldwin D6/601

* cited by examiner

Primary Examiner—Janice E Seeger

(74) *Attorney, Agent, or Firm*—QuickPatents, Inc.; Kevin
Prince

(57) **CLAIM**

What is claimed is the ornamental design for a travel pillow,
as shown and described.

DESCRIPTION

FIG. 1 is a perspective view of a first embodiment of a travel
pillow, showing the new design;

FIG. 2 is a front elevational view thereof;

FIG. 3 is a rear elevational view thereof;

FIG. 4 is a left-side elevational view thereof;

FIG. 5 is a right-side elevational view thereof;

FIG. 6 is a top plan view thereof;

FIG. 7 is a bottom plan view thereof;

FIG. 8 is a perspective view of a second embodiment thereof;

FIG. 9 is a front elevational view thereof;

FIG. 10 is a rear elevational view thereof;

FIG. 11 is a left-side elevational view thereof;

FIG. 12 is a right-side elevational view thereof;

FIG. 13 is a top plan view thereof; and,

FIG. 14 is a bottom plan view thereof.

The broken lines showing an electronic device in FIG. 1 are
included for the purpose of illustrating the invention in use,
and form no part of the claimed design.

1 Claim, 11 Drawing Sheets

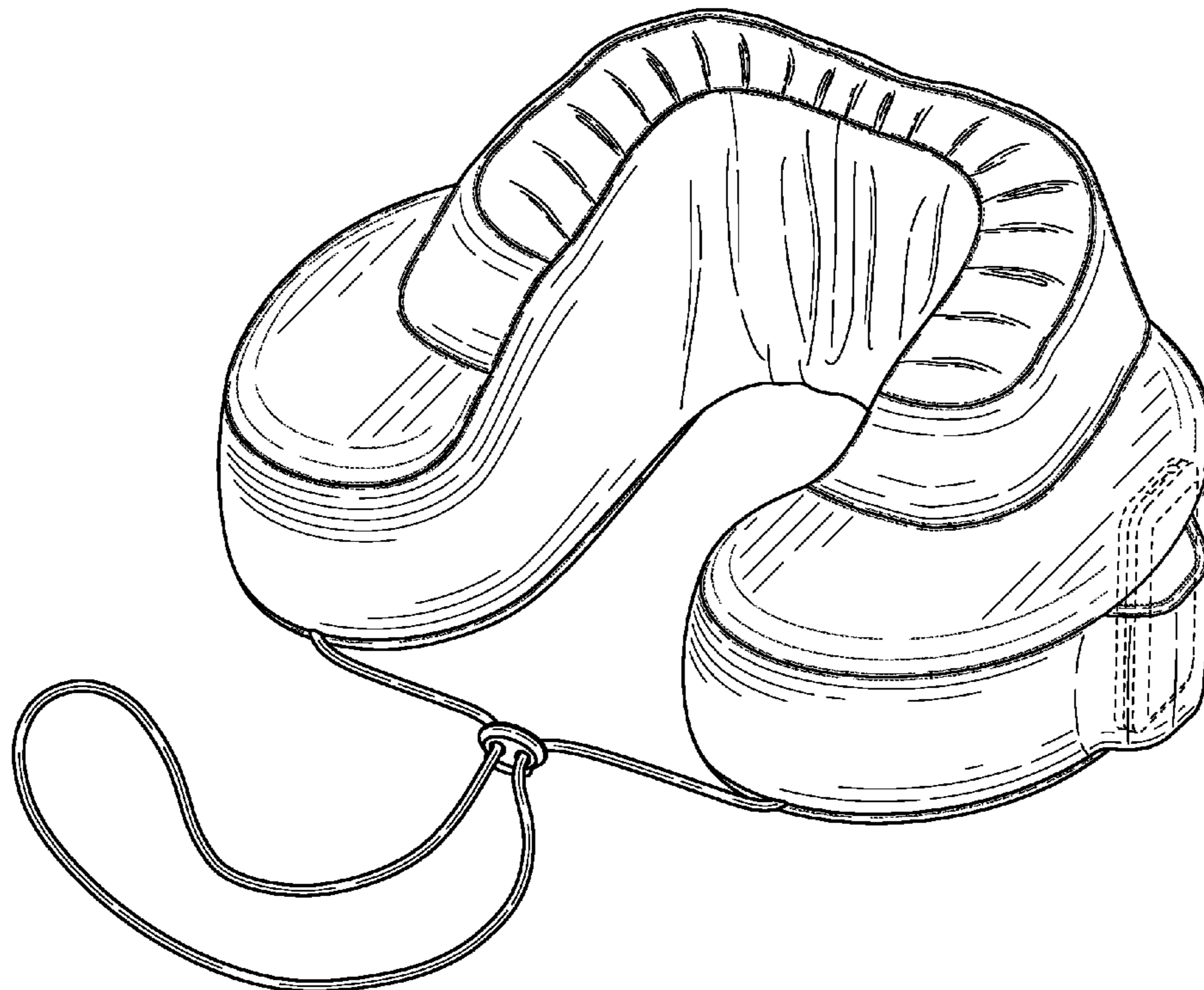

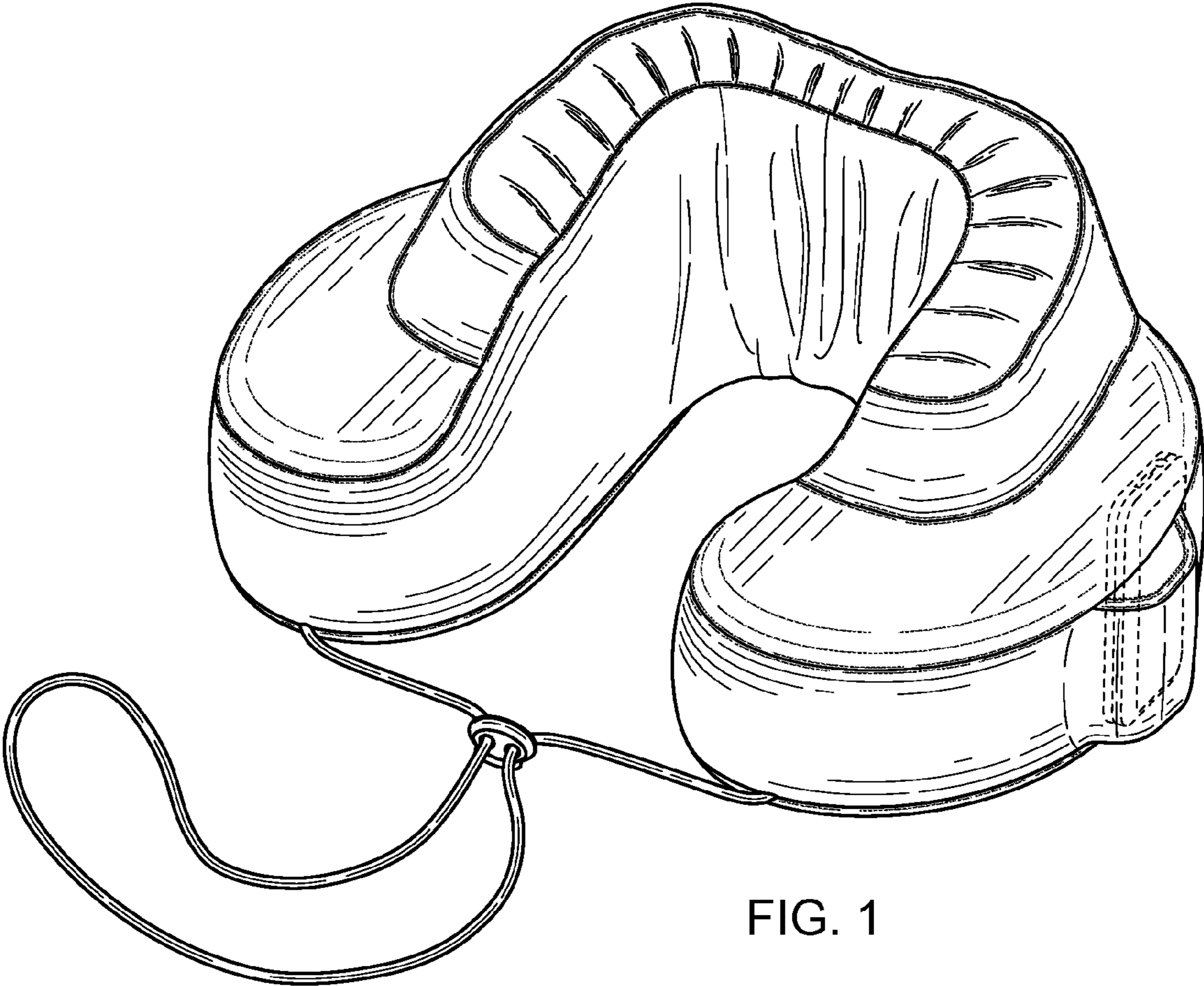

FIG. 1

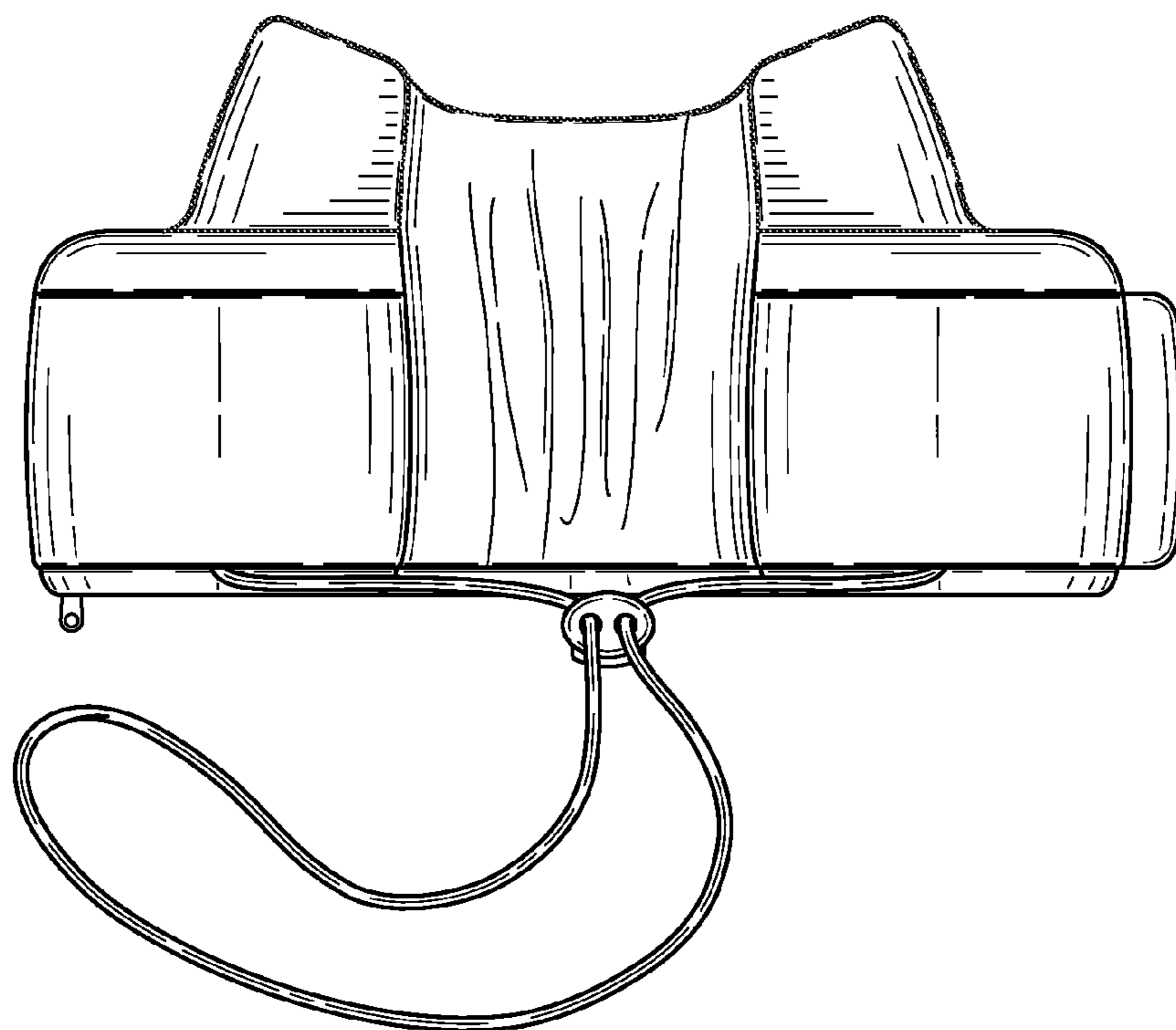

FIG. 2

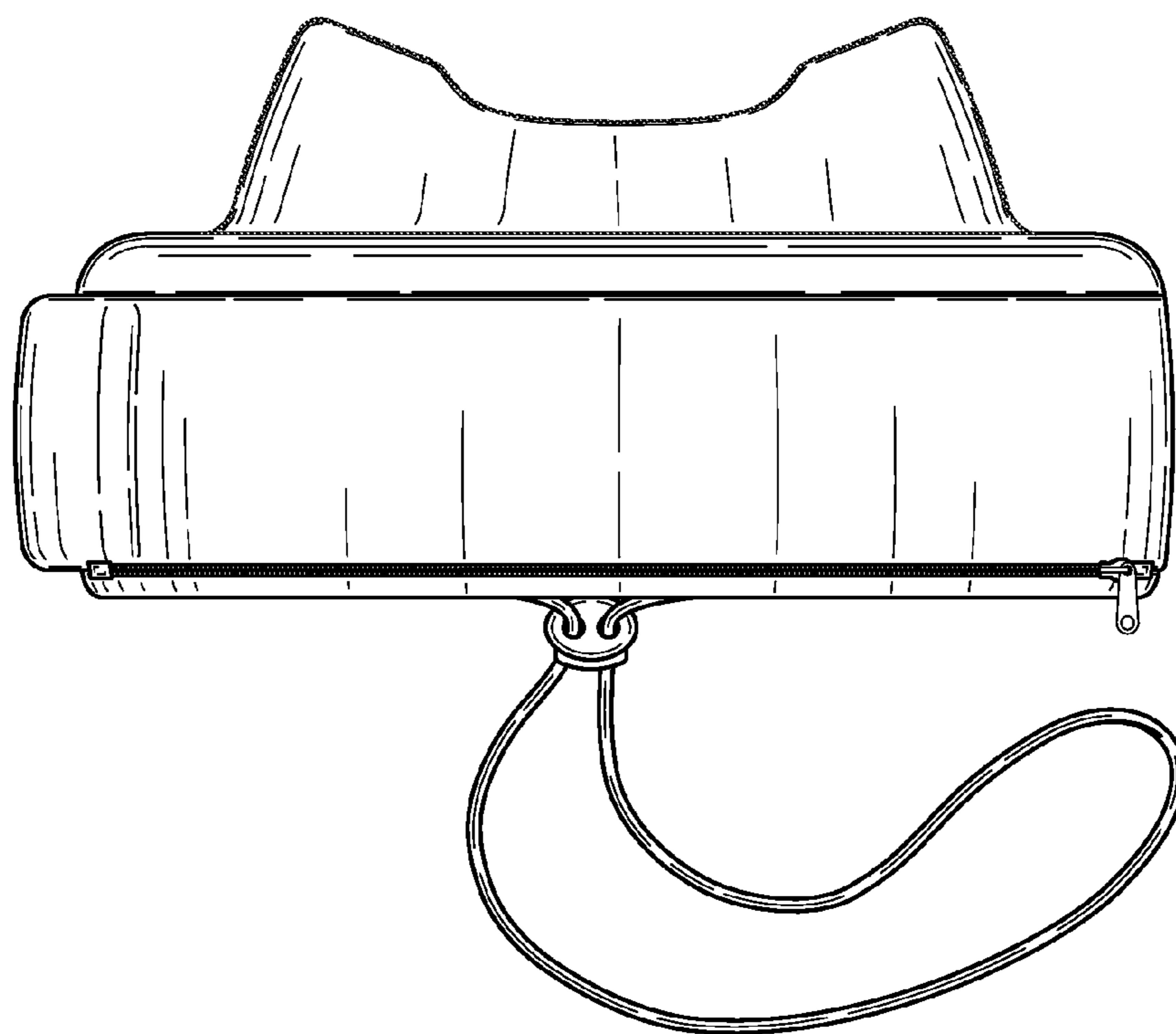

FIG. 3

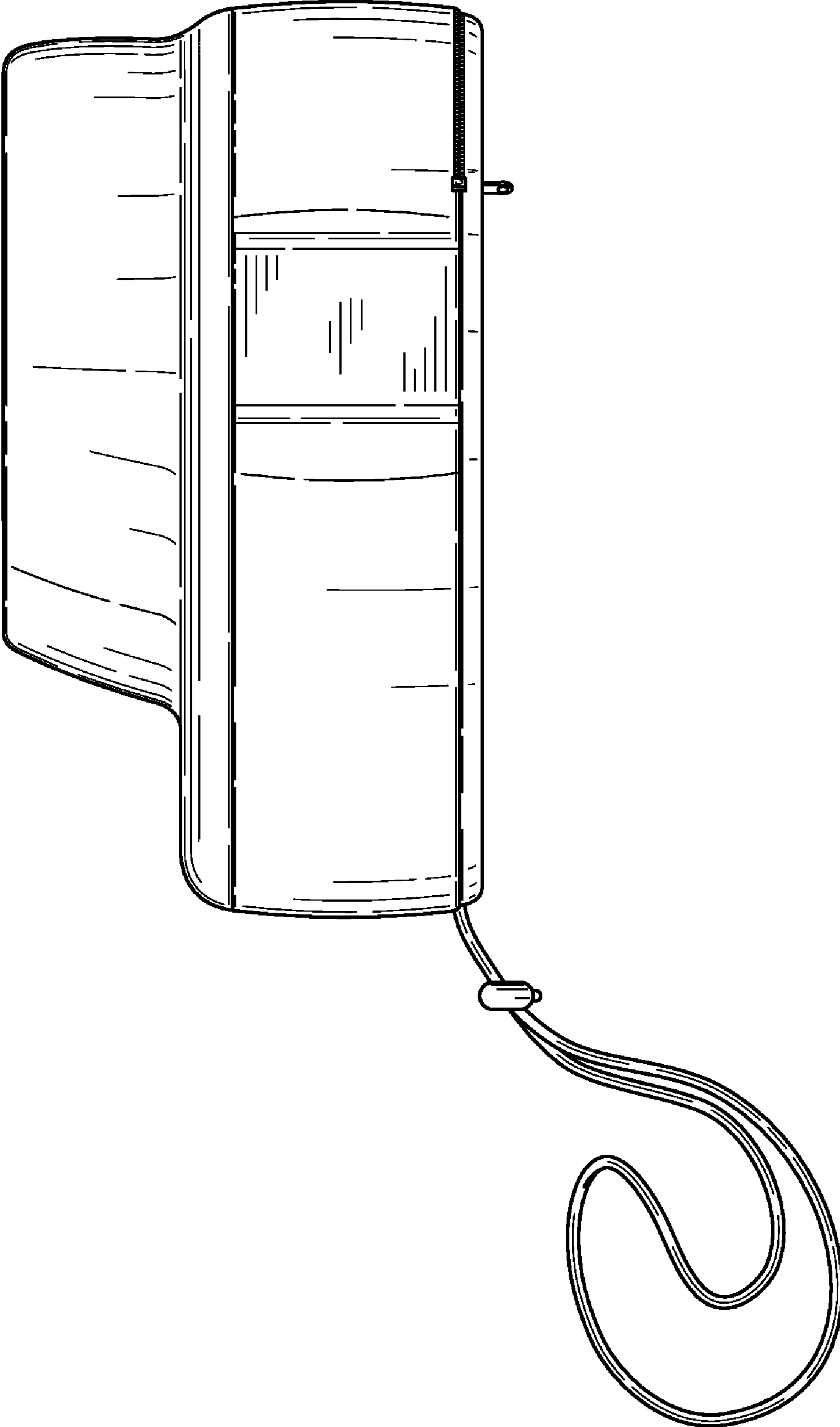

FIG. 4

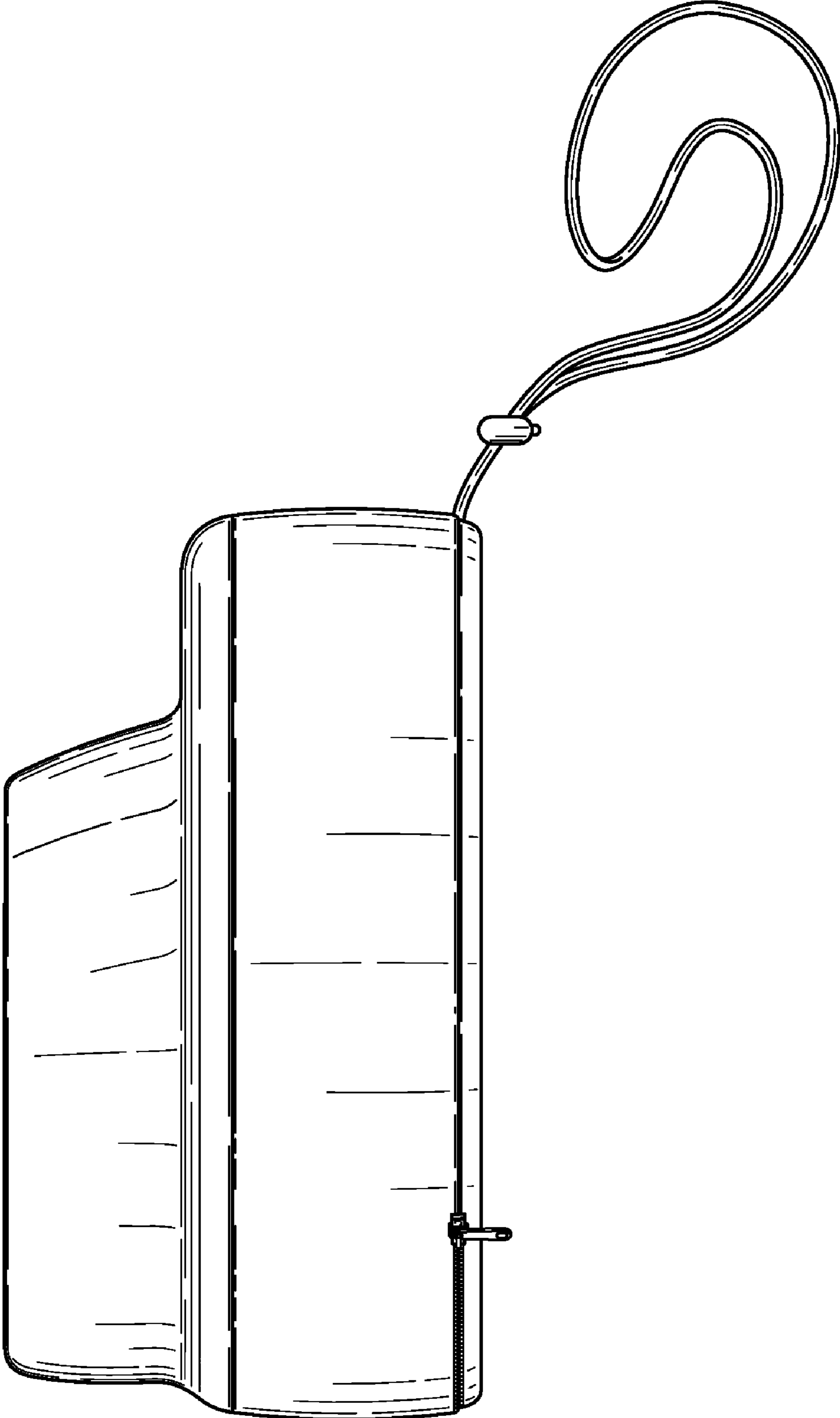

FIG. 5

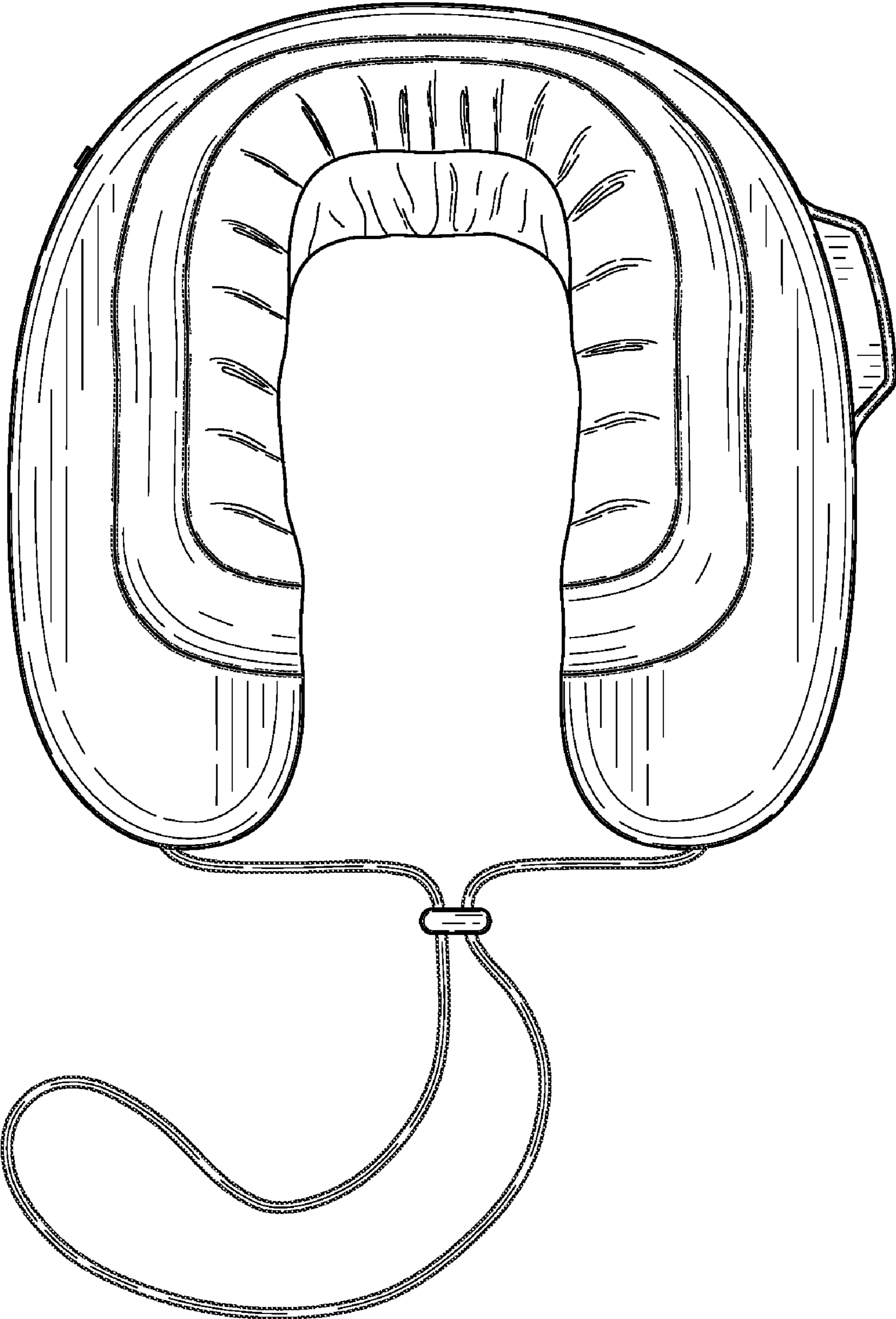

FIG. 6

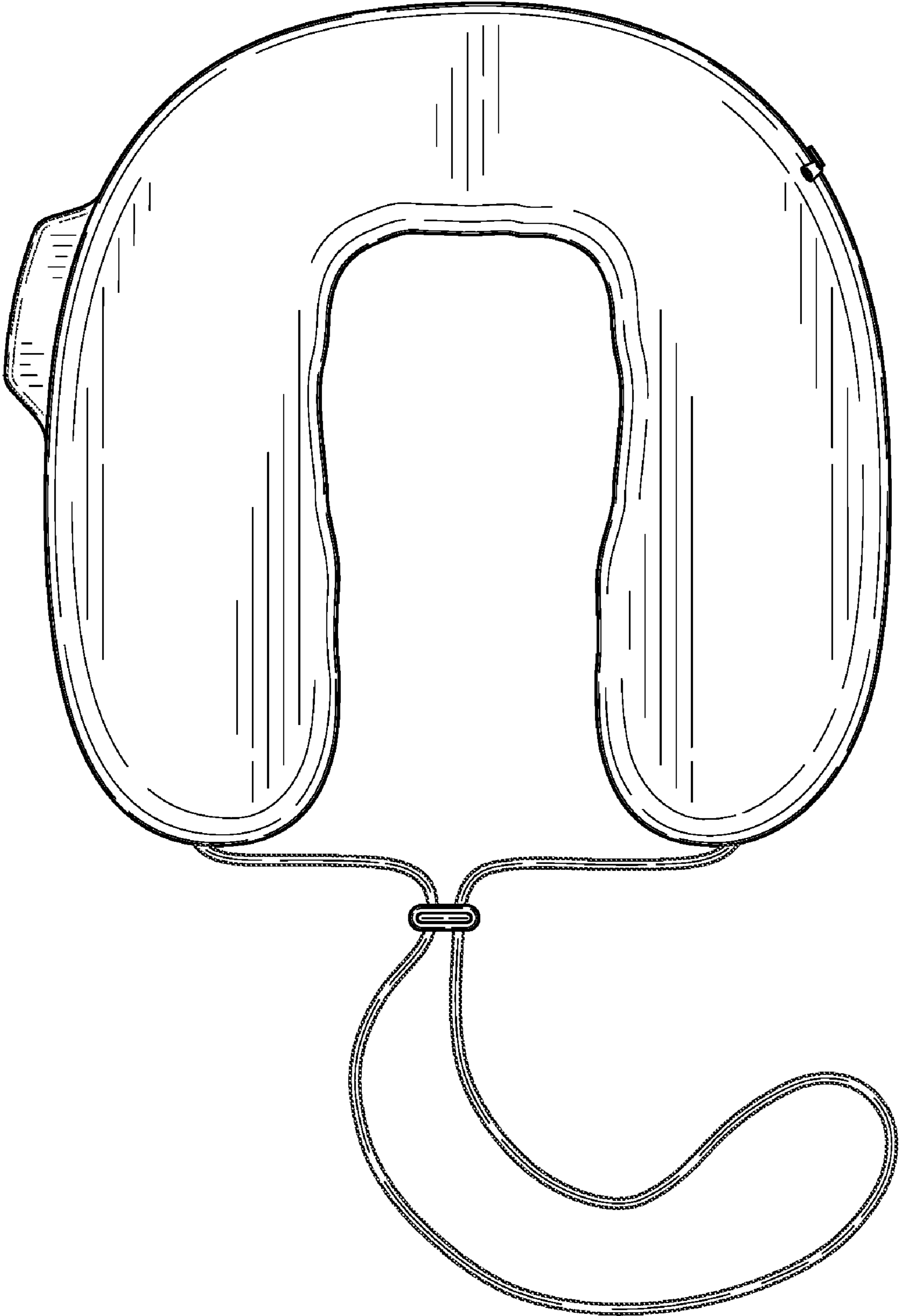

FIG. 7

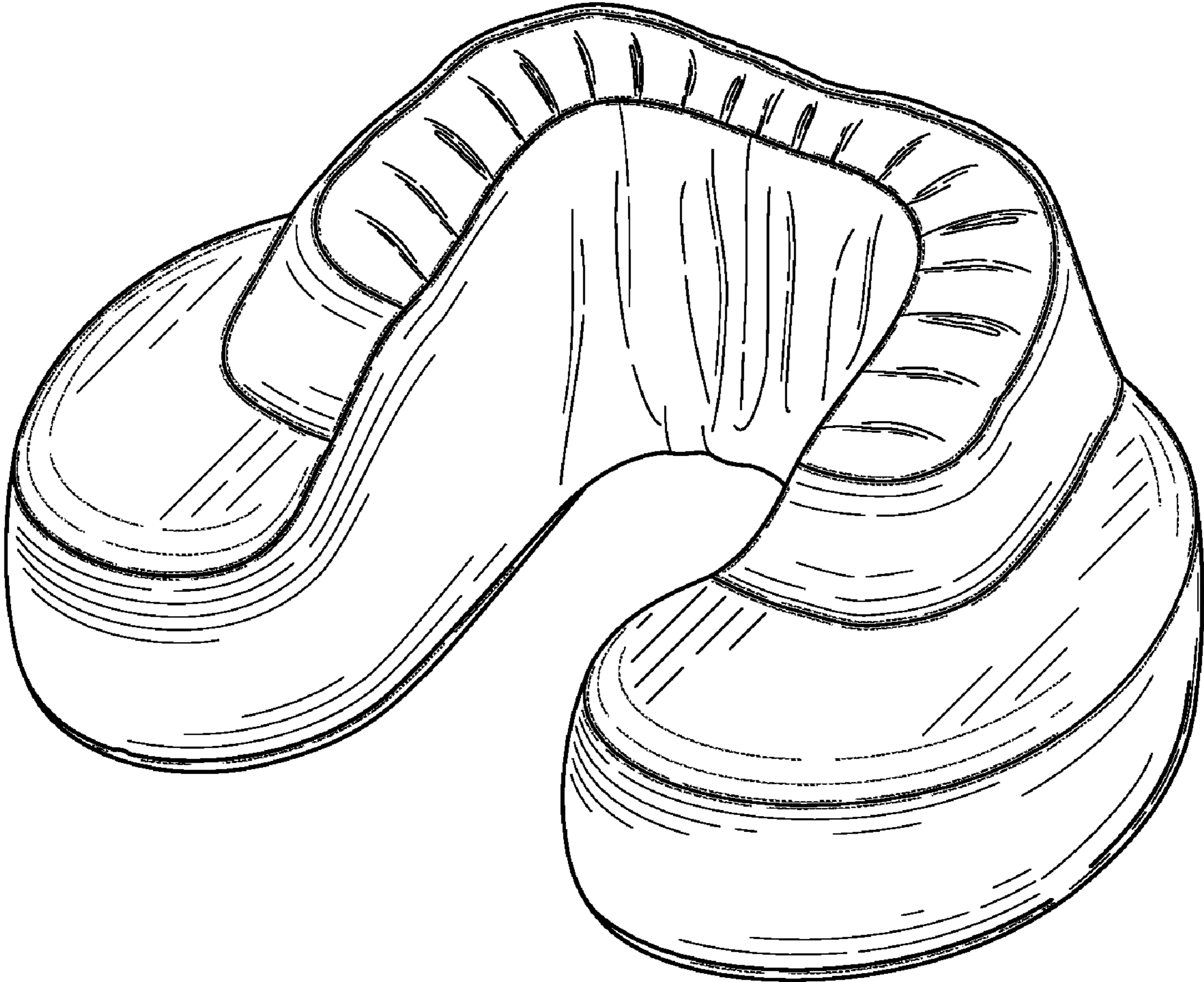

FIG. 8

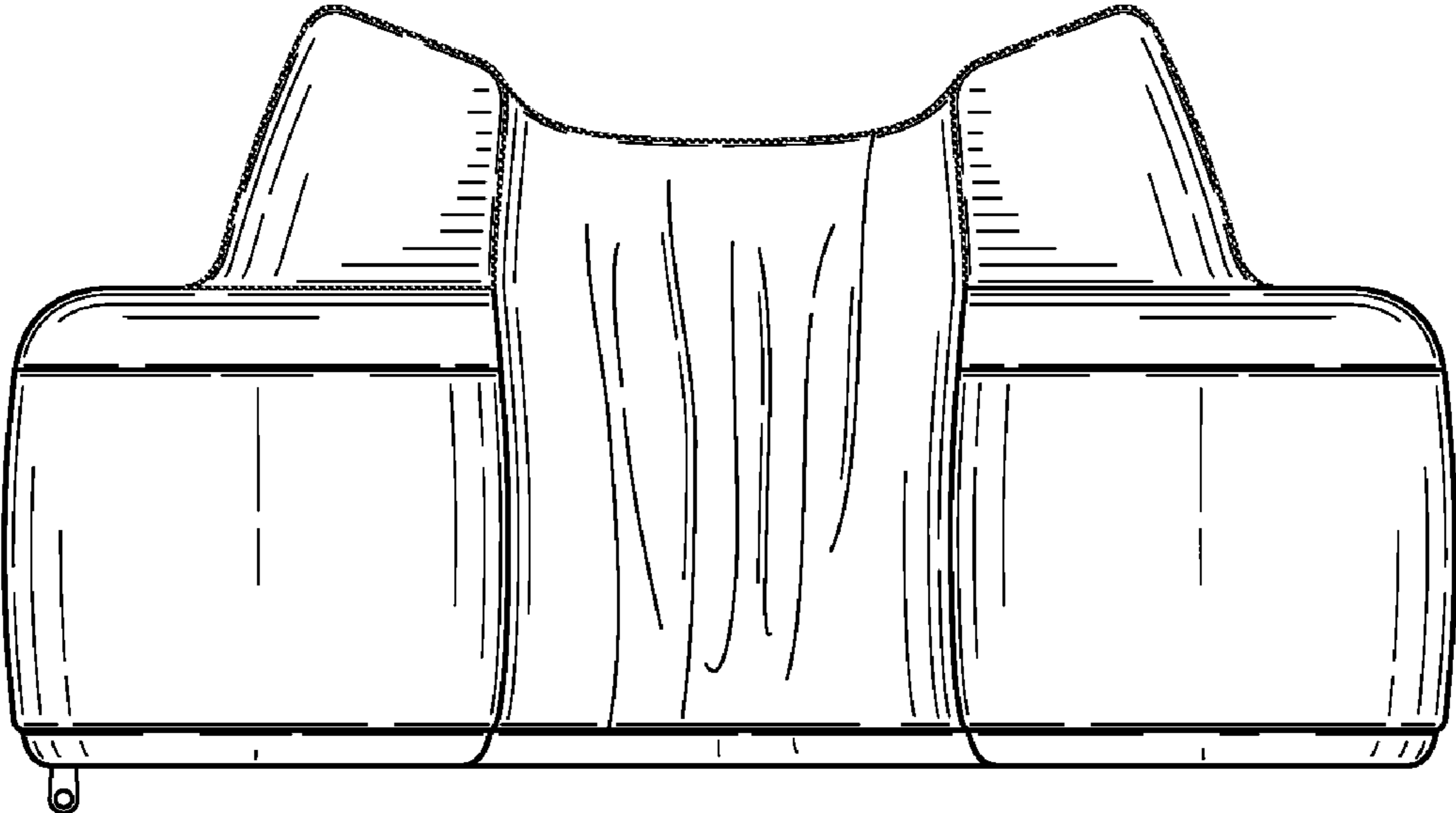

FIG. 9

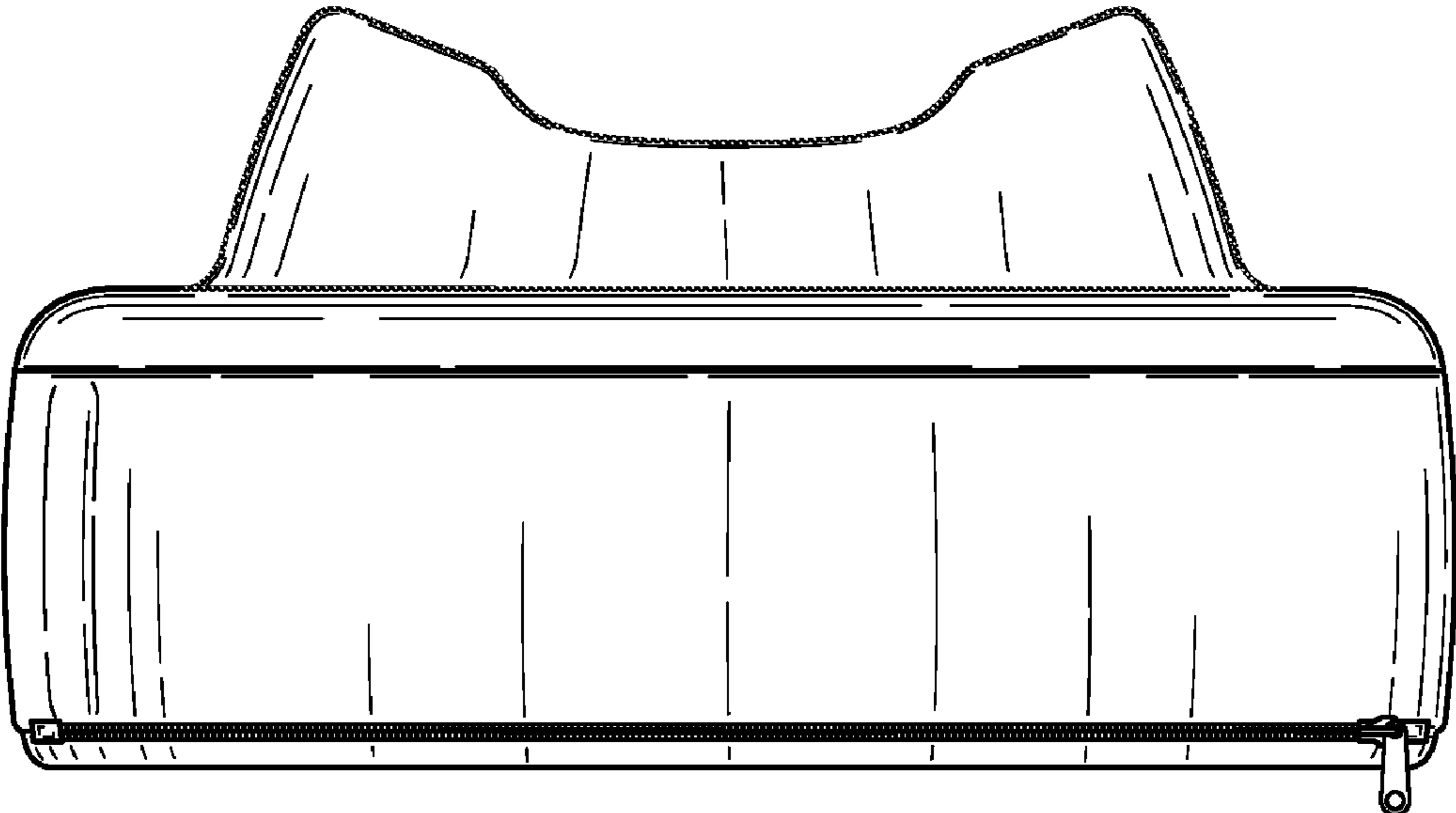

FIG. 10

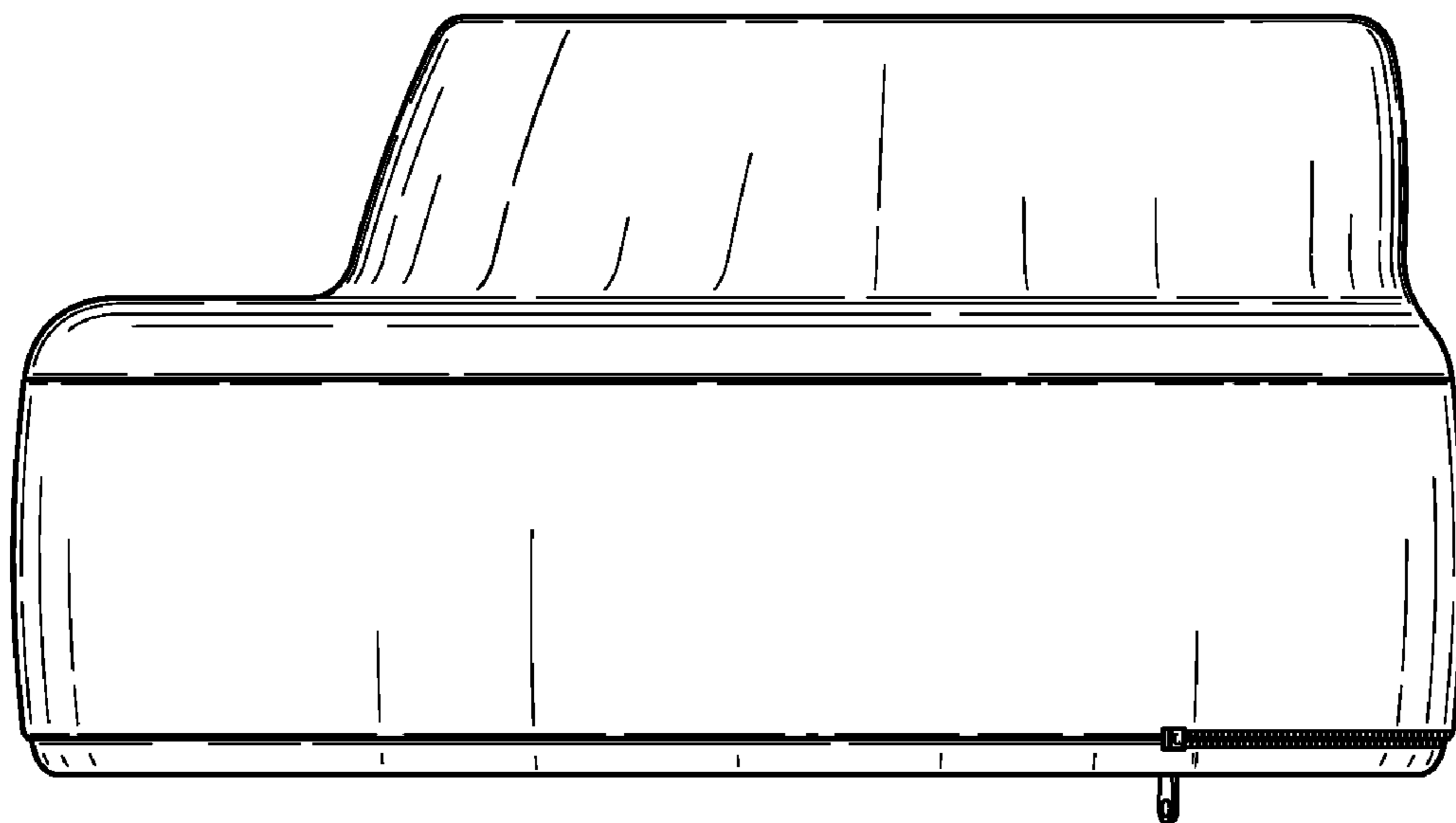

FIG. 11

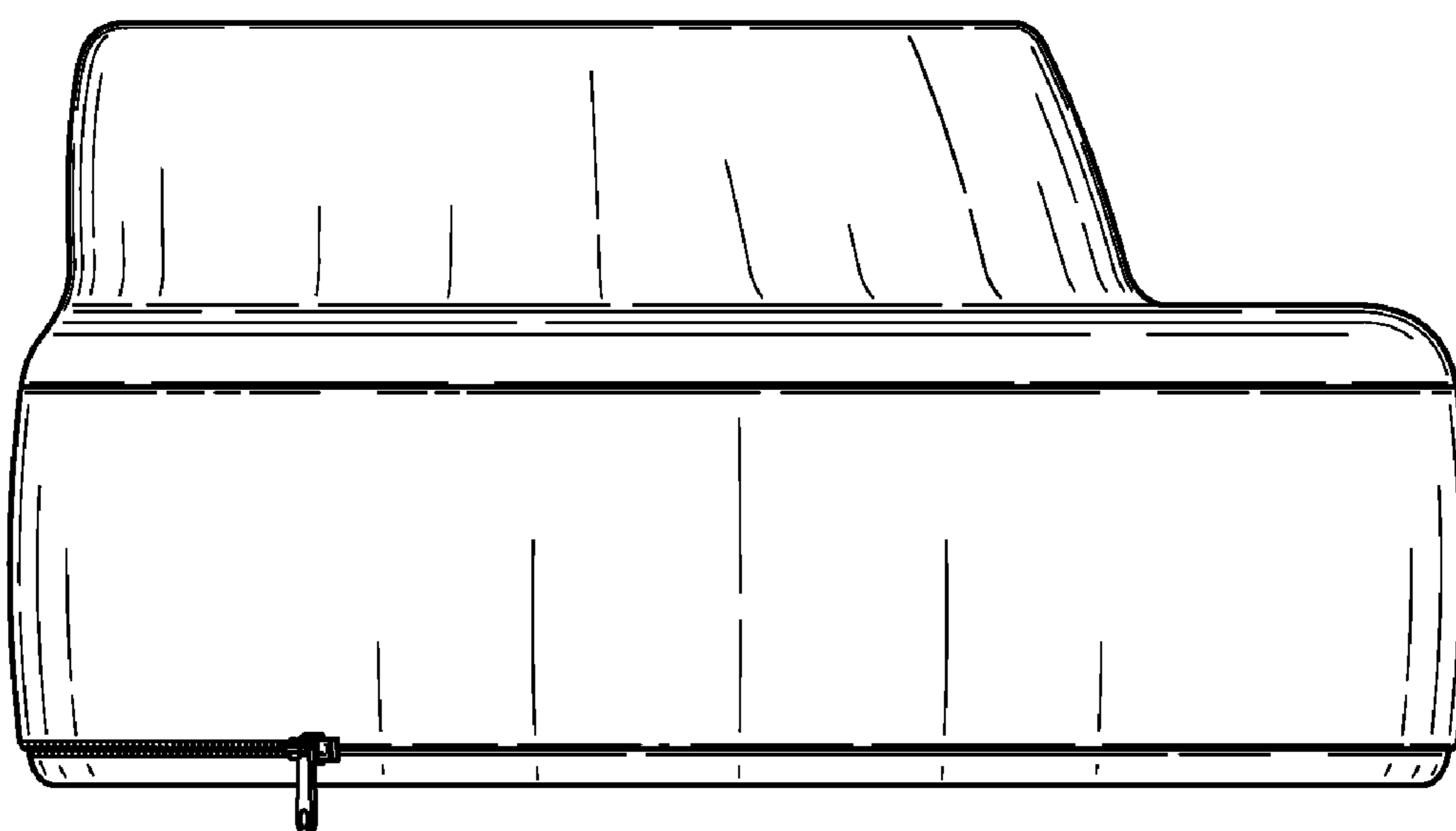

FIG. 12

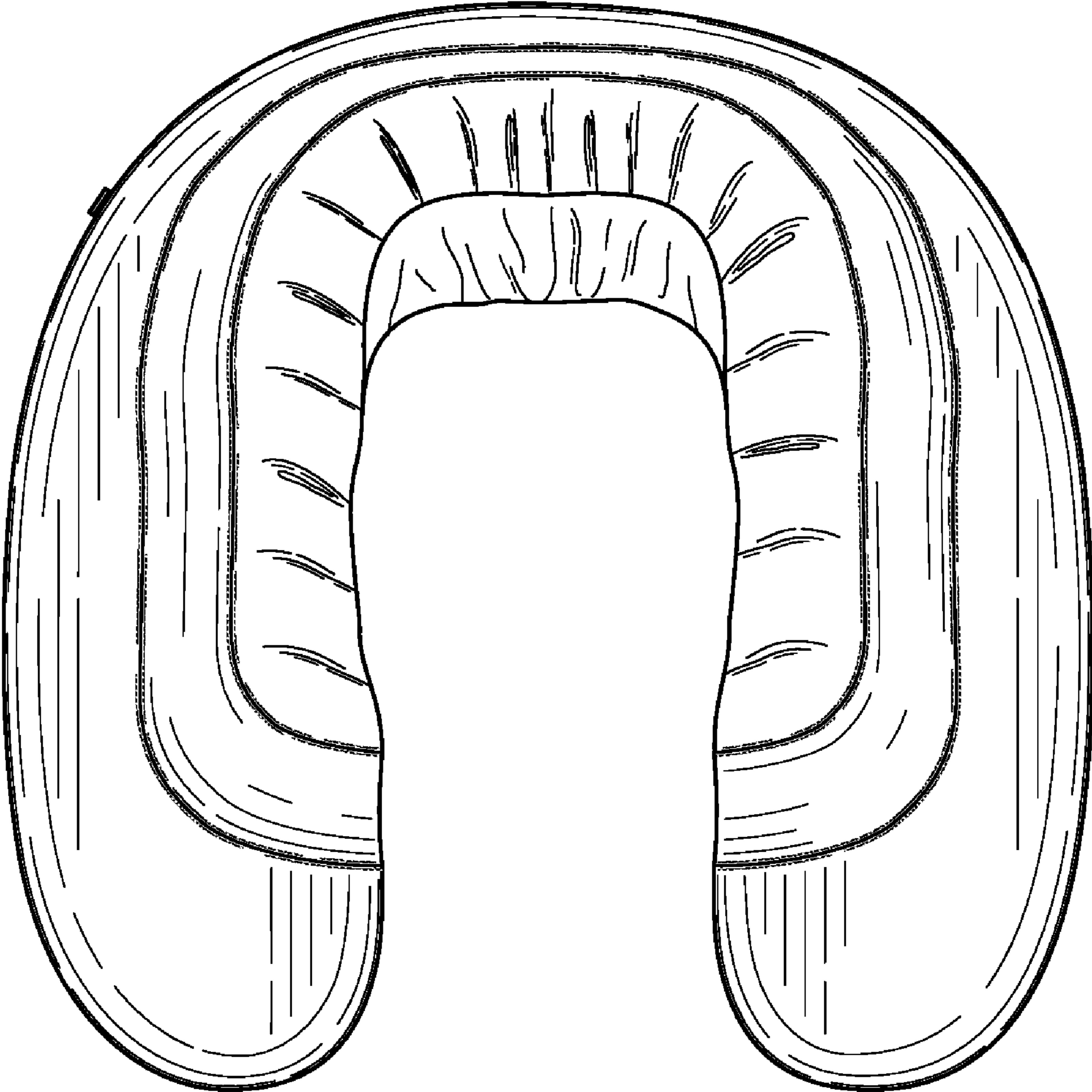

FIG. 13

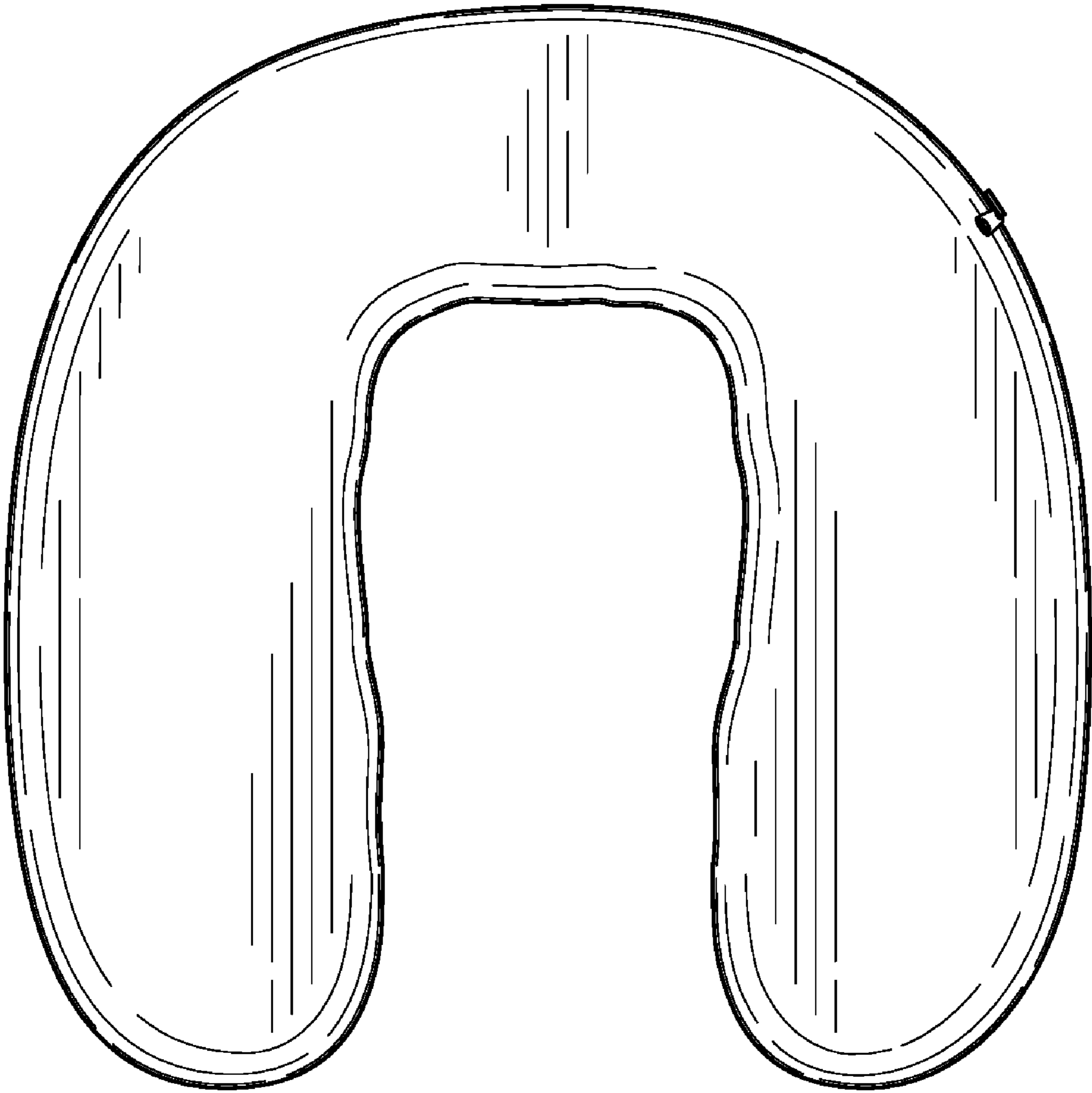

FIG. 14