



US00D619205S

(12) **United States Design Patent**
Jian et al.

(10) **Patent No.:** **US D619,205 S**
(45) **Date of Patent:** **** Jul. 6, 2010**

(54) **SHOWERHEAD**

(75) Inventors: **Zhang Jian**, Piscataway, NJ (US); **Jiang Xuefeng**, Piscataway, NJ (US)

(73) Assignee: **AS IP Holdco, L.L.C.**, Piscataway, NJ (US)

(**) Term: **14 Years**

(21) Appl. No.: **29/344,863**

(22) Filed: **Oct. 6, 2009**

(51) **LOC (9) Cl.** **23-01**

(52) **U.S. Cl.** **D23/223**

(58) **Field of Classification Search** D23/213,
D23/223, 226; 239/282–283; 4/605, 615,
4/570, 567

See application file for complete search history.

(56) **References Cited**

U.S. PATENT DOCUMENTS

D457,598 S *	5/2002	Storti et al.	D23/223
D484,945 S *	1/2004	Ouyoung	D23/213
D518,145 S *	3/2006	Nikles	D23/223
D527,072 S *	8/2006	Wu	D23/223
D545,941 S *	7/2007	Li	D23/223
D559,357 S *	1/2008	Wang et al.	D23/229

D559,948 S *	1/2008	Bickler et al.	D23/223
D565,699 S *	4/2008	Berberet	D23/223
D565,702 S *	4/2008	Daunter et al.	D23/223
D579,517 S *	10/2008	Corbett	D23/223
D581,485 S *	11/2008	Kollmann	D23/223

* cited by examiner

Primary Examiner—Robin V Webster

(74) *Attorney, Agent, or Firm*—Flaster/Greenberg P.C.

(57) **CLAIM**

The ornamental design for a showerhead, as shown and described.

DESCRIPTION

FIG. 1 is a perspective view of a showerhead;
FIG. 2 is a front view of the showerhead of FIG. 1;
FIG. 3 is a right side view of the showerhead of FIG. 1;
FIG. 4 is a left side view of the showerhead of FIG. 1;
FIG. 5 is a top view of the showerhead of FIG. 1;
FIG. 6 is a bottom view of the showerhead of FIG. 1; and,
FIG. 7 is a rear view of the showerhead of FIG. 1.

The broken line showing in FIG. 6 is included for the purpose of illustrating and forms no part of the claimed design.

1 Claim, 3 Drawing Sheets

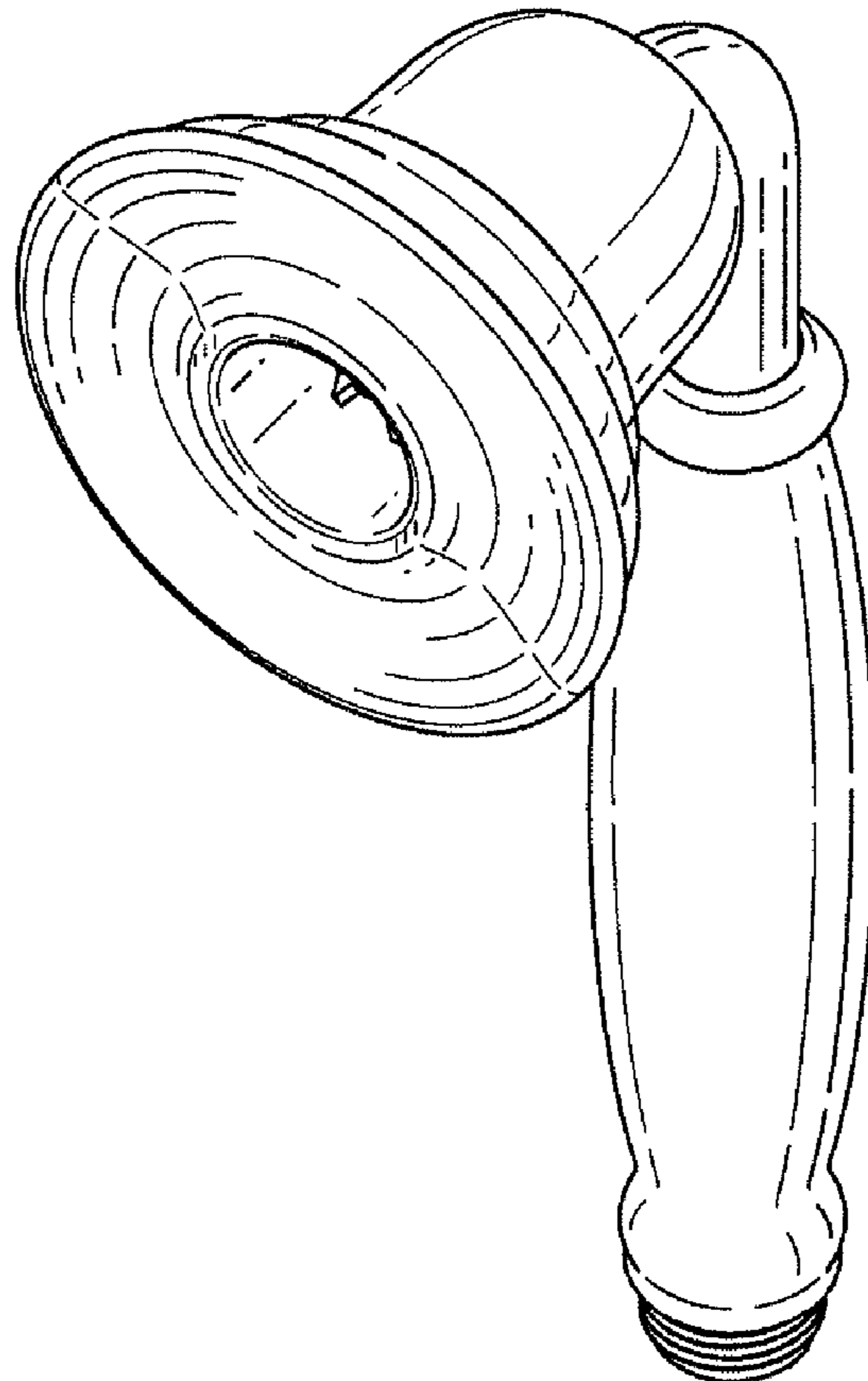

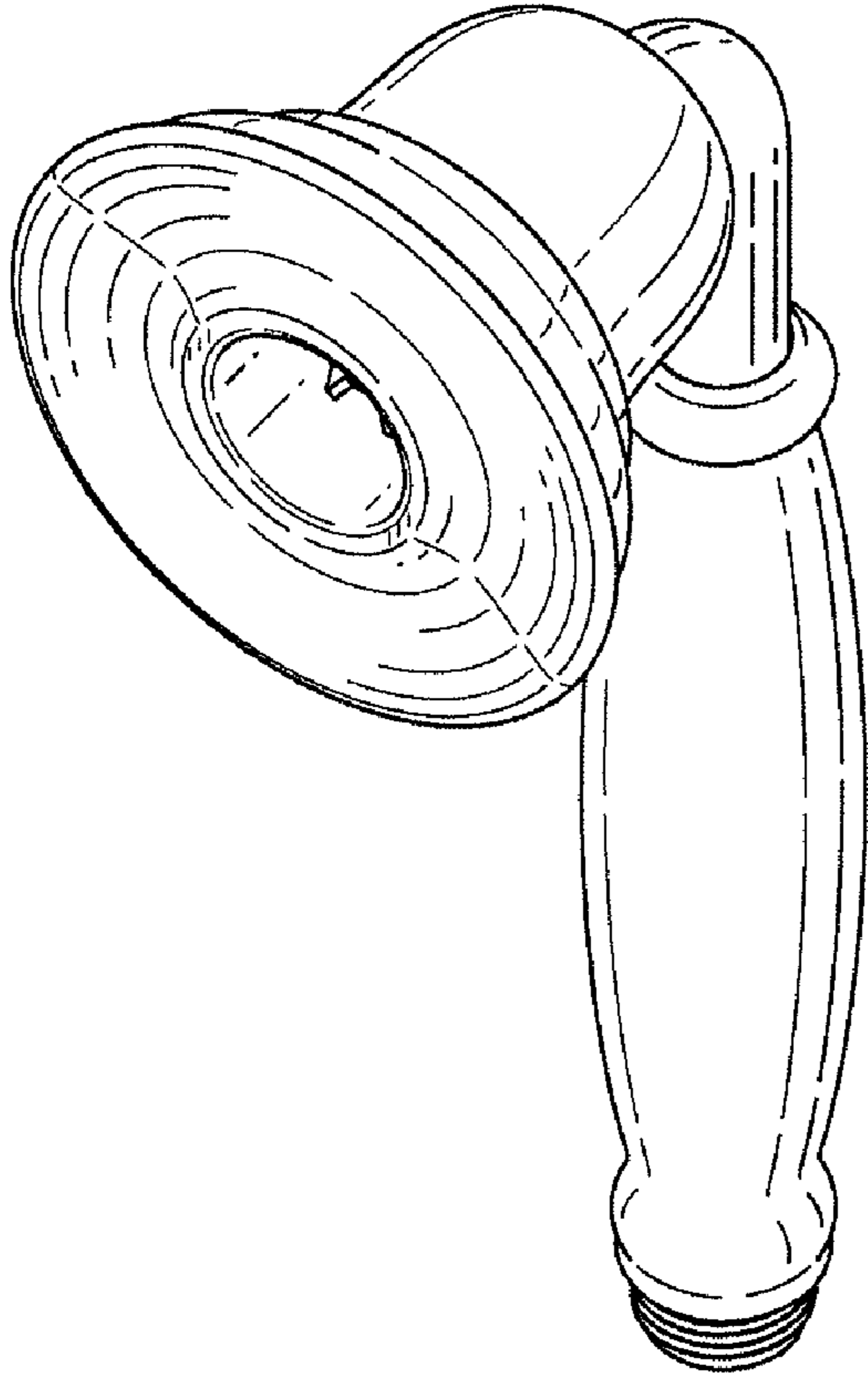

FIG. 1

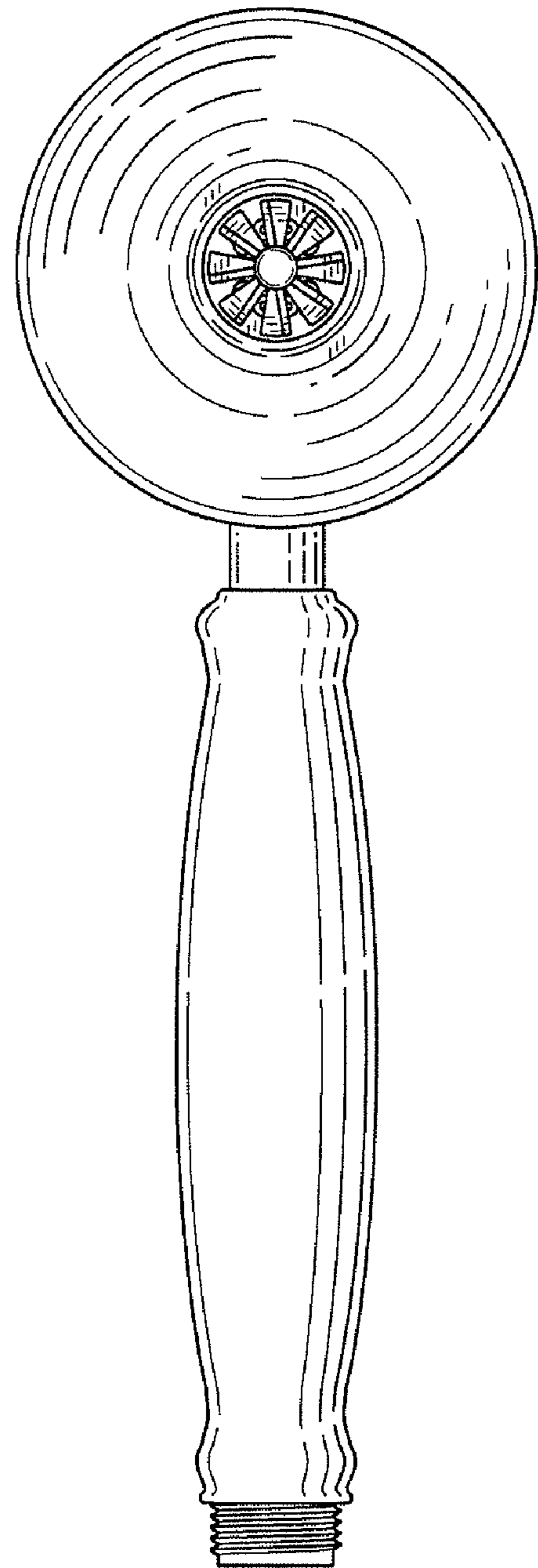

FIG. 2

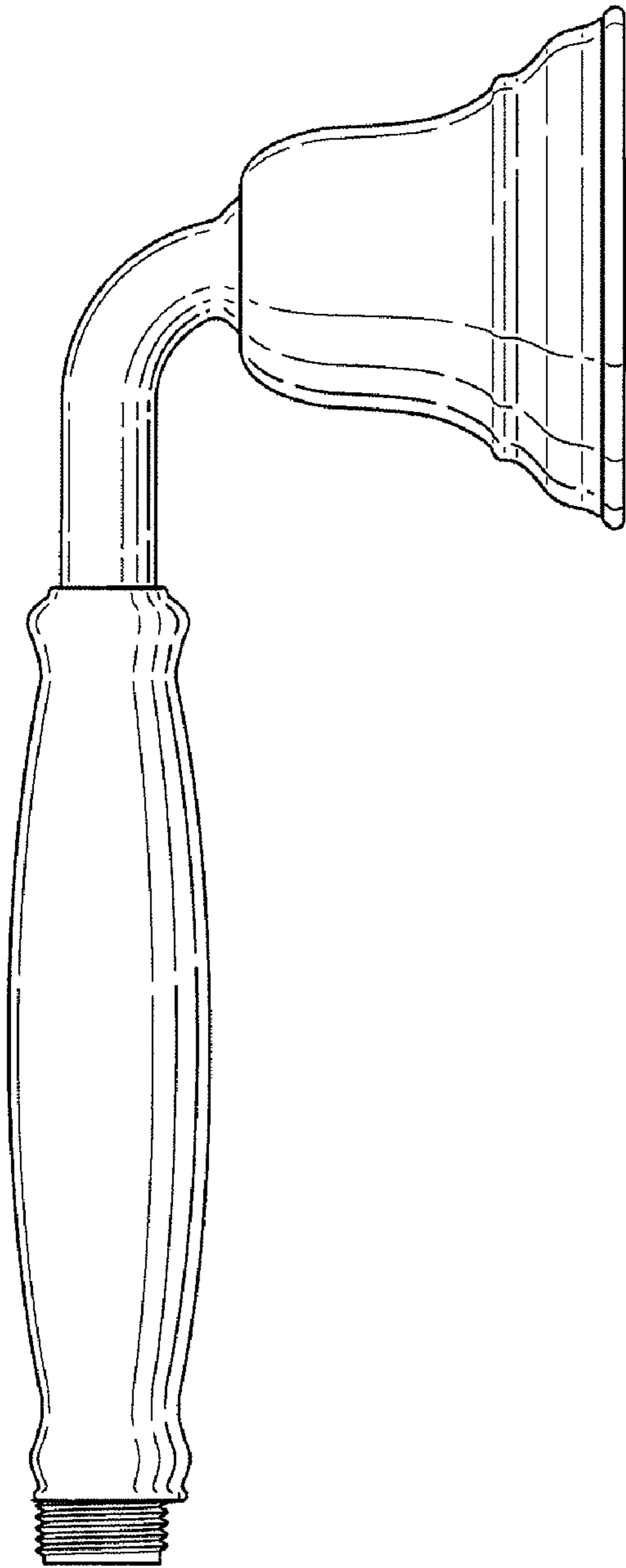

FIG. 3

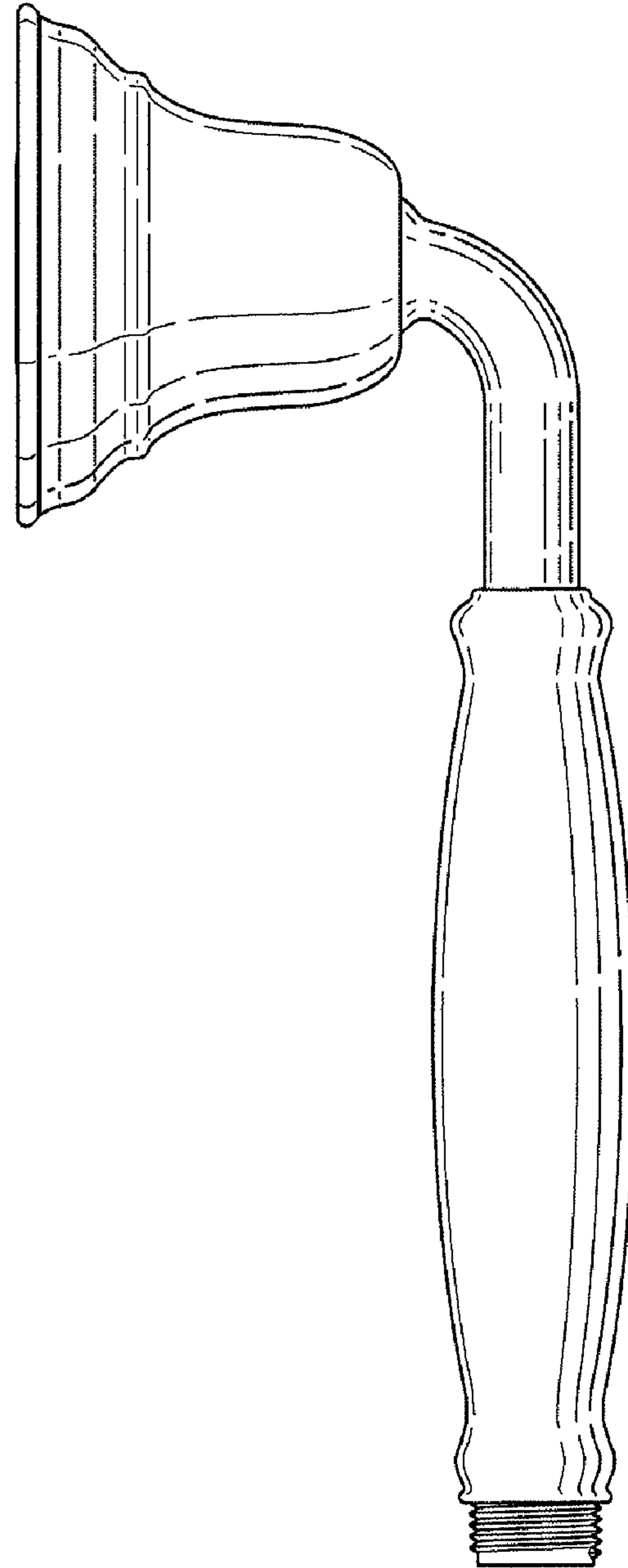

FIG. 4

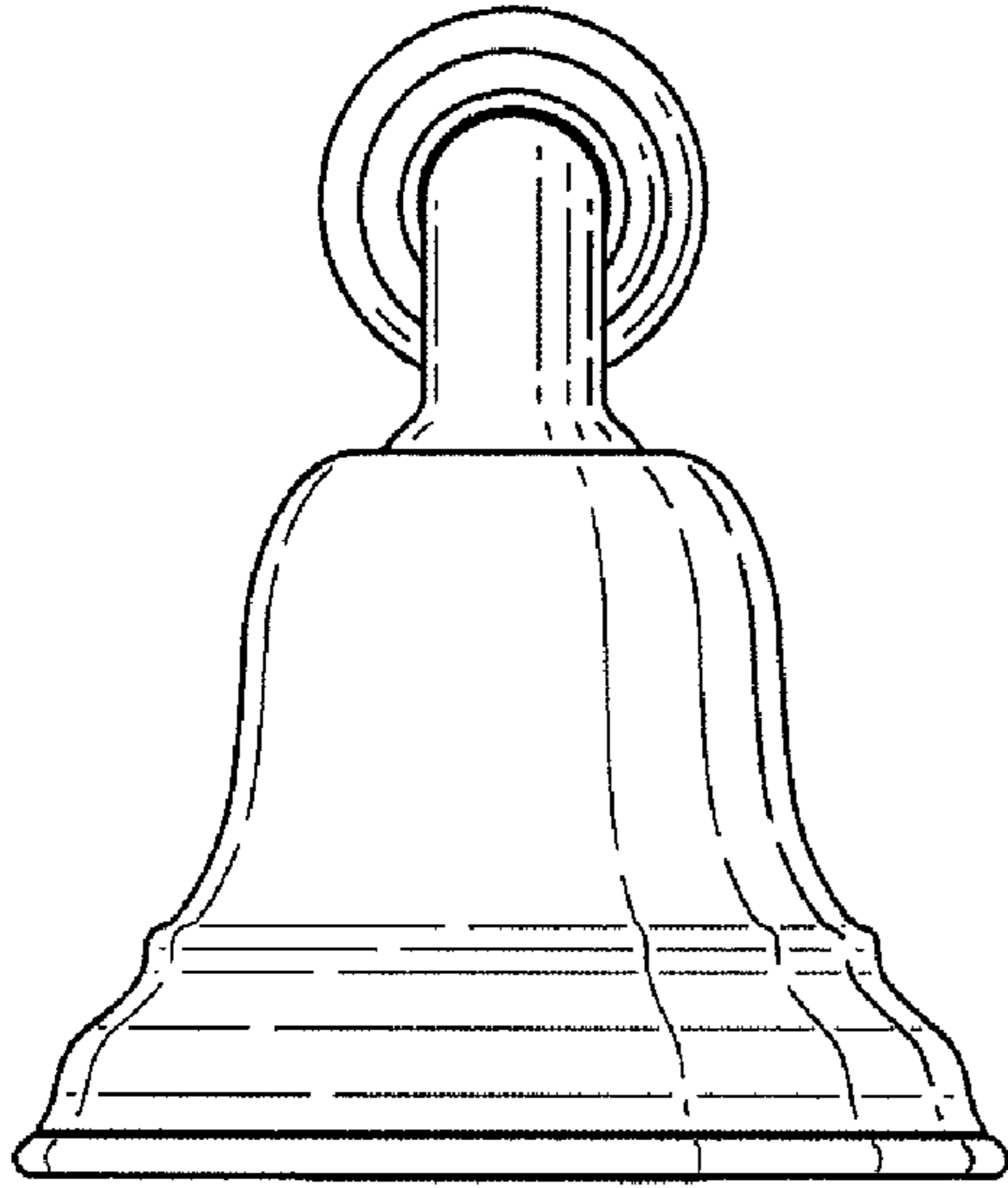

FIG. 5

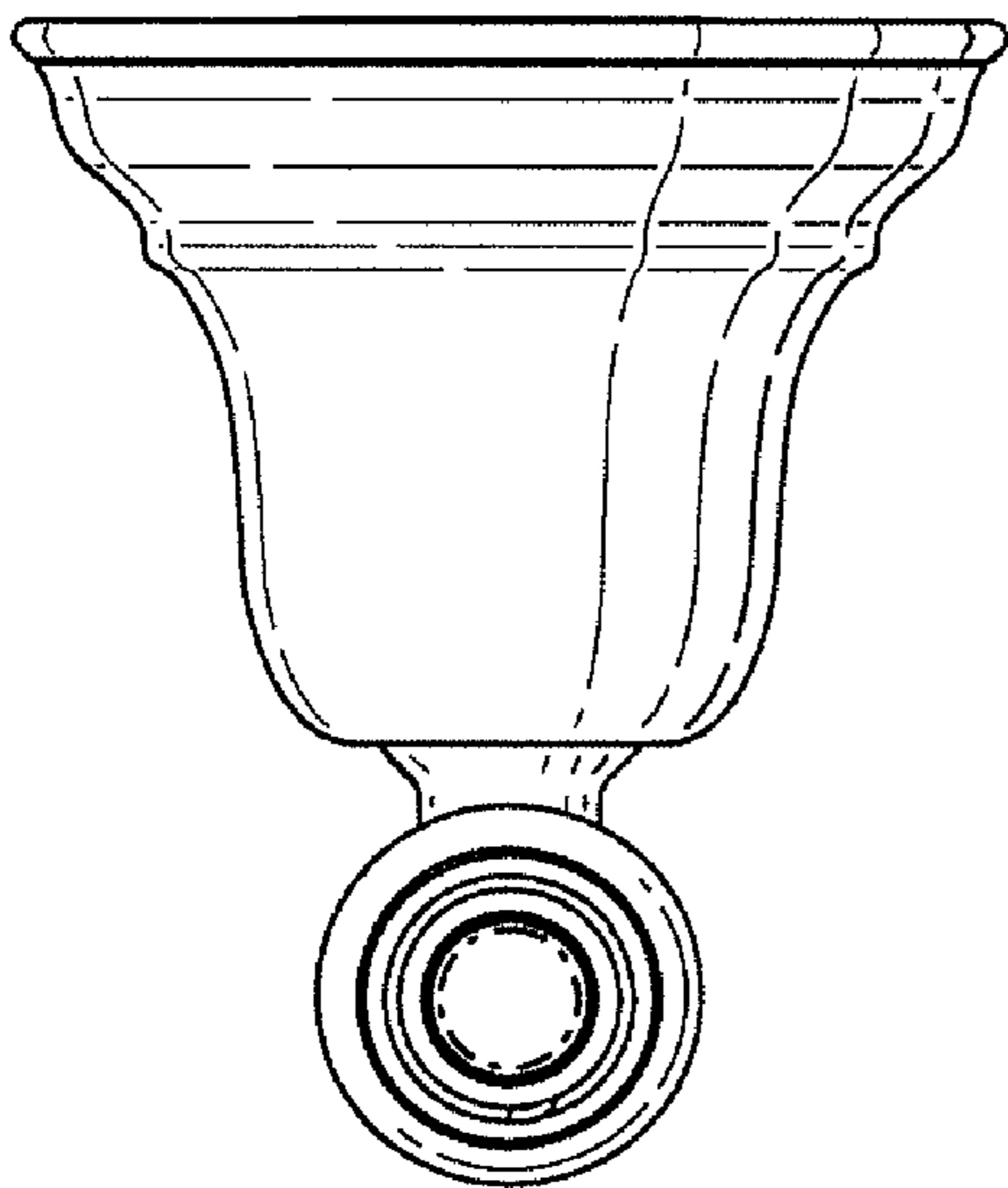

FIG. 6

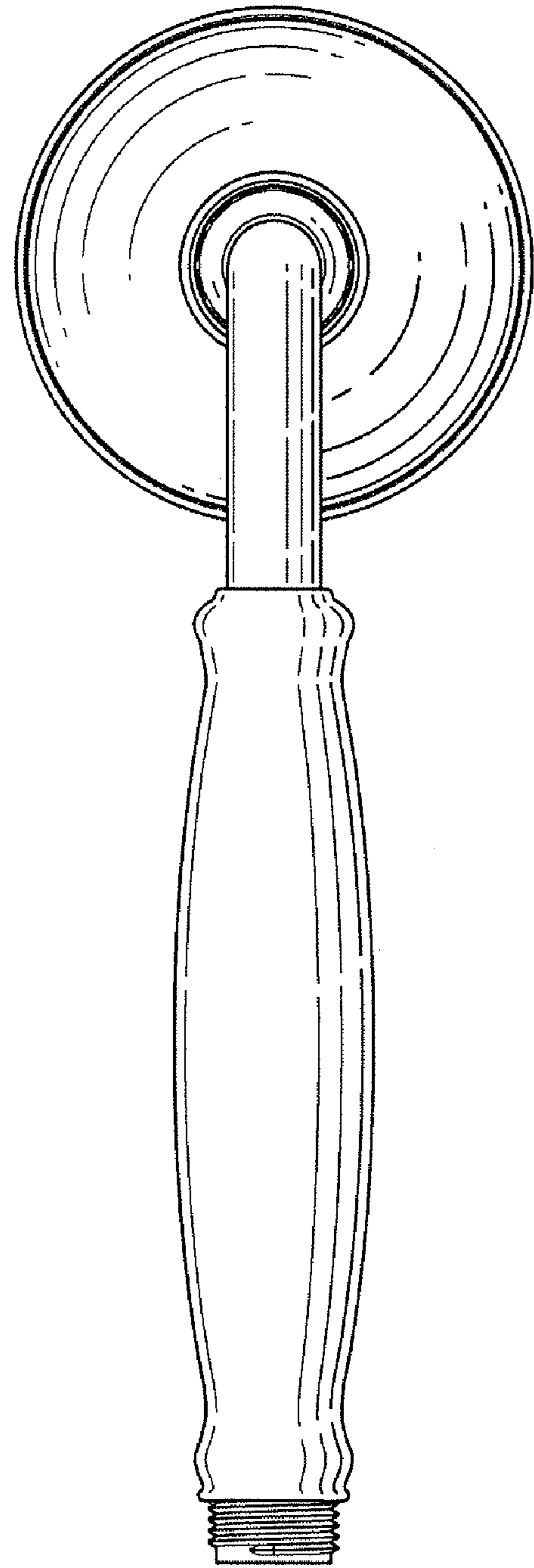

FIG. 7