



US00D619131S

(12) **United States Design Patent**
Oota

(10) **Patent No.:** **US D619,131 S**

(45) **Date of Patent:** **** Jul. 6, 2010**

(54) **OPTICAL DISC PLAYER/RECORDER**

(75) Inventor: **Kiyoshi Oota**, Tokyo (JP)

(73) Assignee: **Sony Corporation**, Tokyo (JP)

(**) Term: **14 Years**

(21) Appl. No.: **29/260,977**

(22) Filed: **Jun. 6, 2006**

(30) **Foreign Application Priority Data**

Dec. 8, 2005 (JP) D2005-036297
Dec. 8, 2005 (JP) D2005-036299

(51) **LOC (9) Cl.** **14-01**

(52) **U.S. Cl.** **D14/257**

(58) **Field of Classification Search** D14/258,
D14/257, 217, 198, 197, 196, 195, 194, 193,
D14/188, 168, 167, 162, 156, 136, 135, 368,
D14/165; 386/68, 91, 52; 455/350, 347,
455/344

See application file for complete search history.

(56) **References Cited**

U.S. PATENT DOCUMENTS

D348,064 S * 6/1994 Saito et al. D14/193
D355,197 S * 2/1995 Farinelli et al. D14/257
D360,419 S * 7/1995 Weber et al. D14/240
D373,589 S * 9/1996 Peterson et al. D14/257
D409,159 S * 5/1999 Wein, Jr. D13/182
D438,183 S * 2/2001 Sato et al. D14/136
D447,134 S * 8/2001 Kiai D14/257
D469,428 S * 1/2003 Senda et al. D14/257
D491,189 S * 6/2004 Williams D14/439
D494,172 S * 8/2004 Asai D14/368
D494,554 S * 8/2004 Wu D14/136
D506,984 S * 7/2005 Oikawa D14/136
D511,757 S * 11/2005 Wu D14/136
D511,763 S * 11/2005 Deguchi D14/167
D512,036 S * 11/2005 Wu D14/136
D512,391 S * 12/2005 Chiu D14/136
D512,419 S * 12/2005 Juskiewicz et al. D14/257
D512,995 S * 12/2005 Storti et al. D14/257

D517,031 S * 3/2006 Wu D14/136
D517,514 S * 3/2006 Wu D14/136
D518,471 S * 4/2006 Deguchi D14/167
D559,240 S * 1/2008 Paradise D14/257
D559,241 S * 1/2008 Paradise D14/257
D561,766 S * 2/2008 Deng D14/442
D573,592 S * 7/2008 Divine et al. D14/257
D574,376 S * 8/2008 Park D14/257

OTHER PUBLICATIONS

Office Action mailed on Jun. 15, 2007 (Japan).
Patent Office Prior Art No. HC14017030, "Hi-Fi Audio Catalog", p. 10, Japan (Apr. 26, 2002).
Patent Office Prior Art No. HC14008755, "Presta Since 1990", p. 14, Japan (Mar. 8, 2002).

* cited by examiner

Primary Examiner—Cathron C Brooks
Assistant Examiner—Austin Murphy
(74) *Attorney, Agent, or Firm*—Rader, Fishman & Grauer, PLLC

(57) **CLAIM**

The ornamental design for an optical disc player/recorder, as shown and described.

DESCRIPTION

The patent or application file contains at least one drawing executed in color. Copies of this patent or patent application publication with color drawing(s) will be provided by the Office upon request and payment of the necessary fee.

FIG. 1 is a front elevational view of a first embodiment of an optical disc player/recorder showing my new design;

FIG. 2 is a first perspective view thereof;

FIG. 3 is a second perspective view thereof;

FIG. 4 is a front elevational view thereof;

FIG. 5 is a partially enlarged first perspective view thereof;

FIG. 6 is a partially enlarged second perspective view thereof;

FIG. 7 is a rear elevational view thereof;

FIG. 8 is a right side view thereof;

FIG. 9 is a left side elevation view thereof;

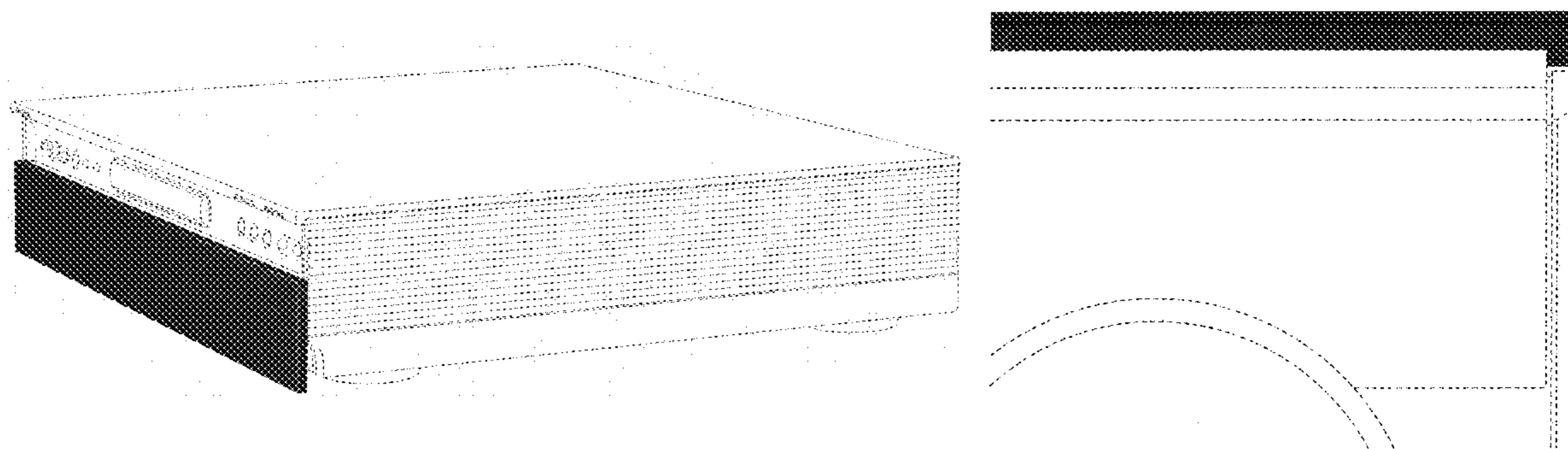

FIG. **10** is a top plan view thereof;
FIG. **11** is a bottom plan view thereof;
FIG. **12** is a view;
FIG. **13** is a first perspective view thereof;
FIG. **14** is a second perspective view thereof;
FIG. **15** is a front elevational view thereof;
FIG. **16** is a partially enlarged first perspective view thereof;
FIG. **17** is a partially enlarged second perspective view thereof;
FIG. **18** is the first perspective view thereof wherein the front panel is lowered;
FIG. **19** is the second perspective view thereof wherein the front panel is lowered;
FIG. **20** is a rear elevational view thereof;
FIG. **21** is a right side elevational view thereof;

FIG. **22** is a left side elevational view thereof;
FIG. **23** is a top plan view thereof;
FIG. **24** is a bottom plan view thereof;
FIG. **25** is a partially enlarged view of the optical disc player/recorder shown in FIG. **2**;
FIG. **26** is a partially enlarged view of the optical disc player/recorder shown in FIG. **11**;
FIG. **27** is a partially enlarged view of the optical disc player/recorder shown in FIG. **16**; and,
FIG. **28** is a partially enlarged view of the optical disc player/recorder shown in FIG. **24**.
Portions in broken lines are for illustrative purposes only and form no part of claimed design.

1 Claim, 28 Drawing Sheets
(16 of 28 Drawing Sheet(s) Filed in Color)

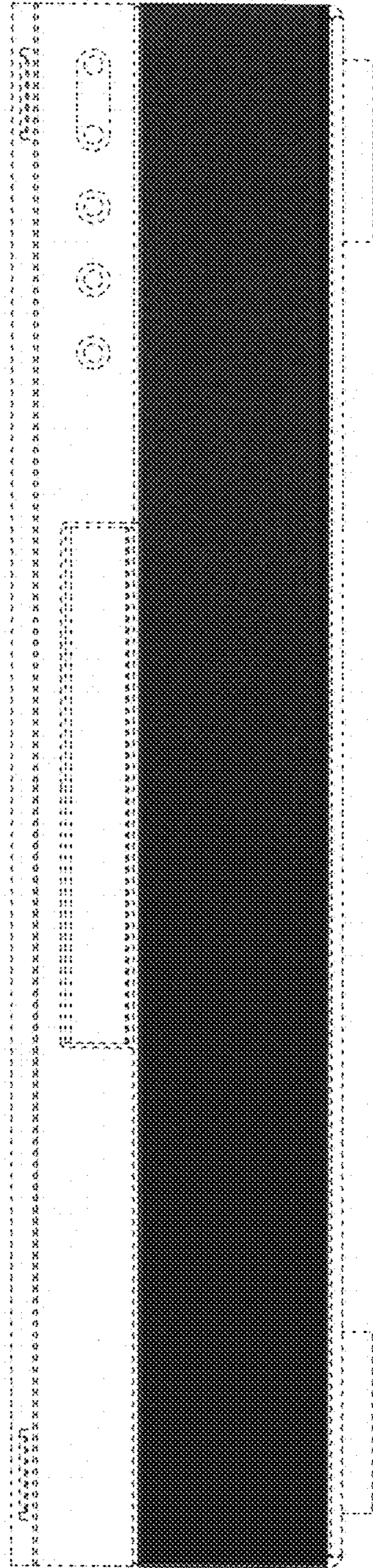

FIG. 1

FIG.2

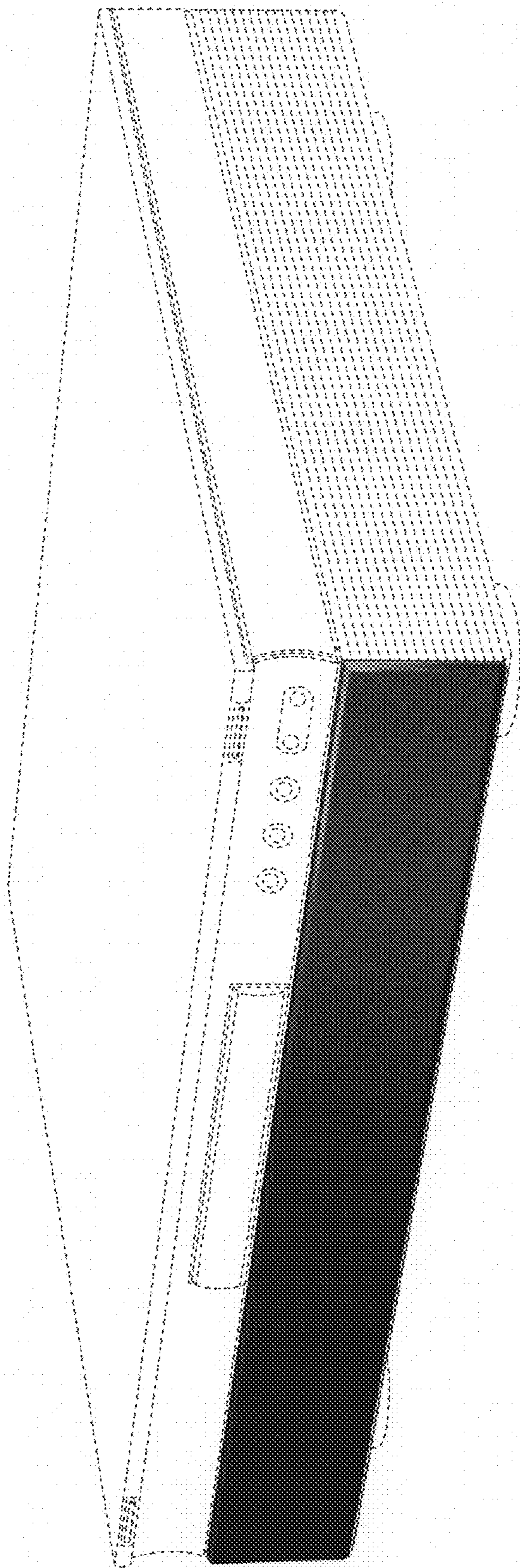

FIG.3

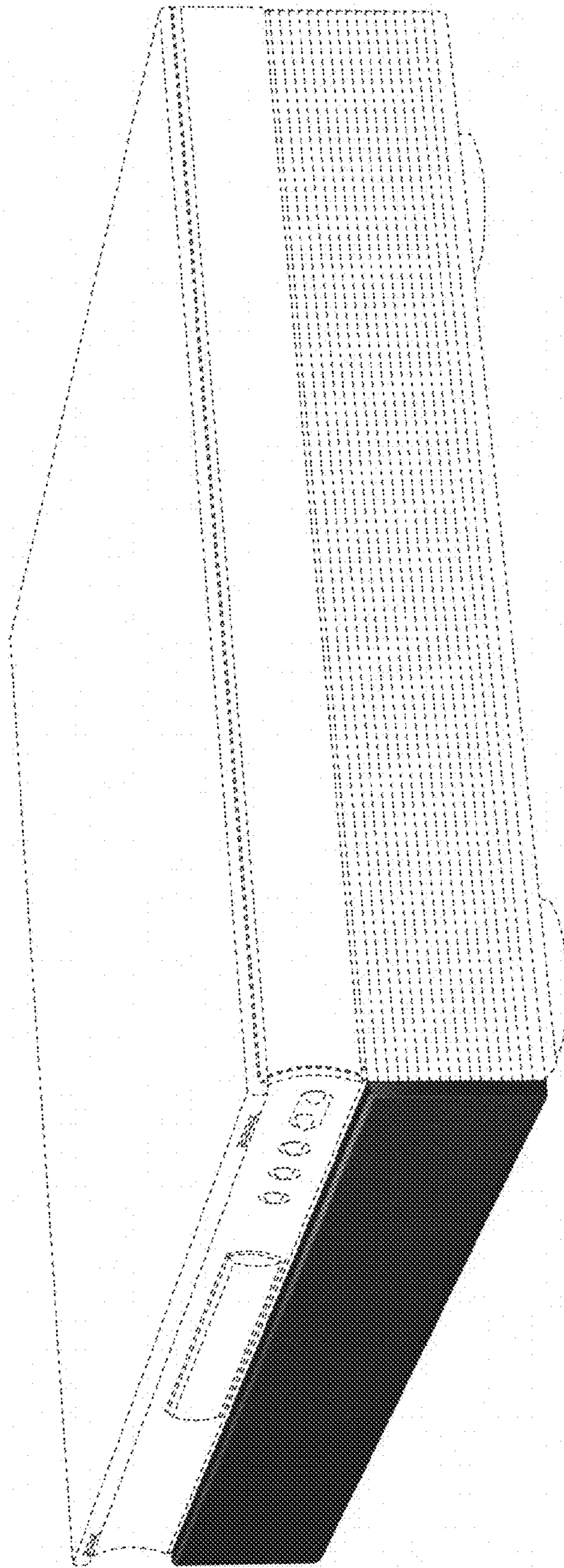

FIG.4

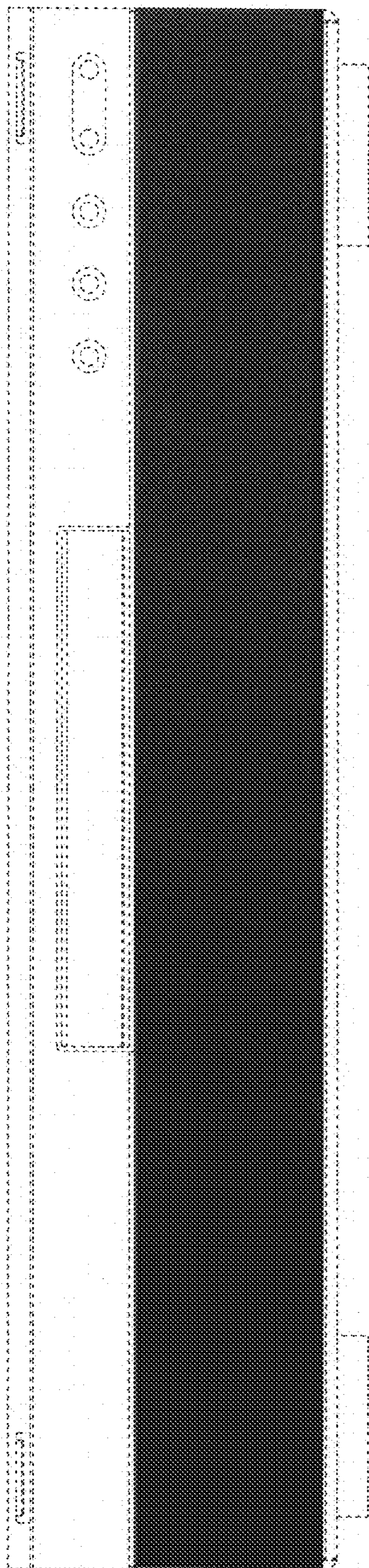

FIG. 5

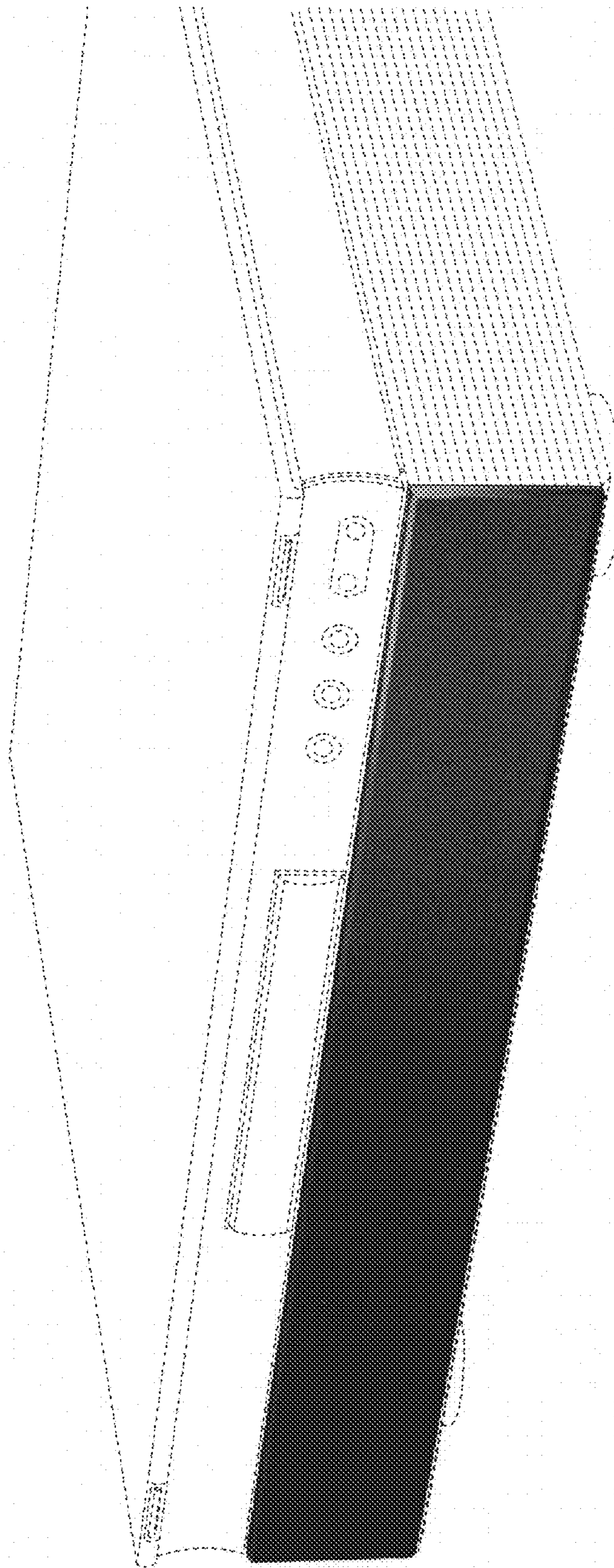
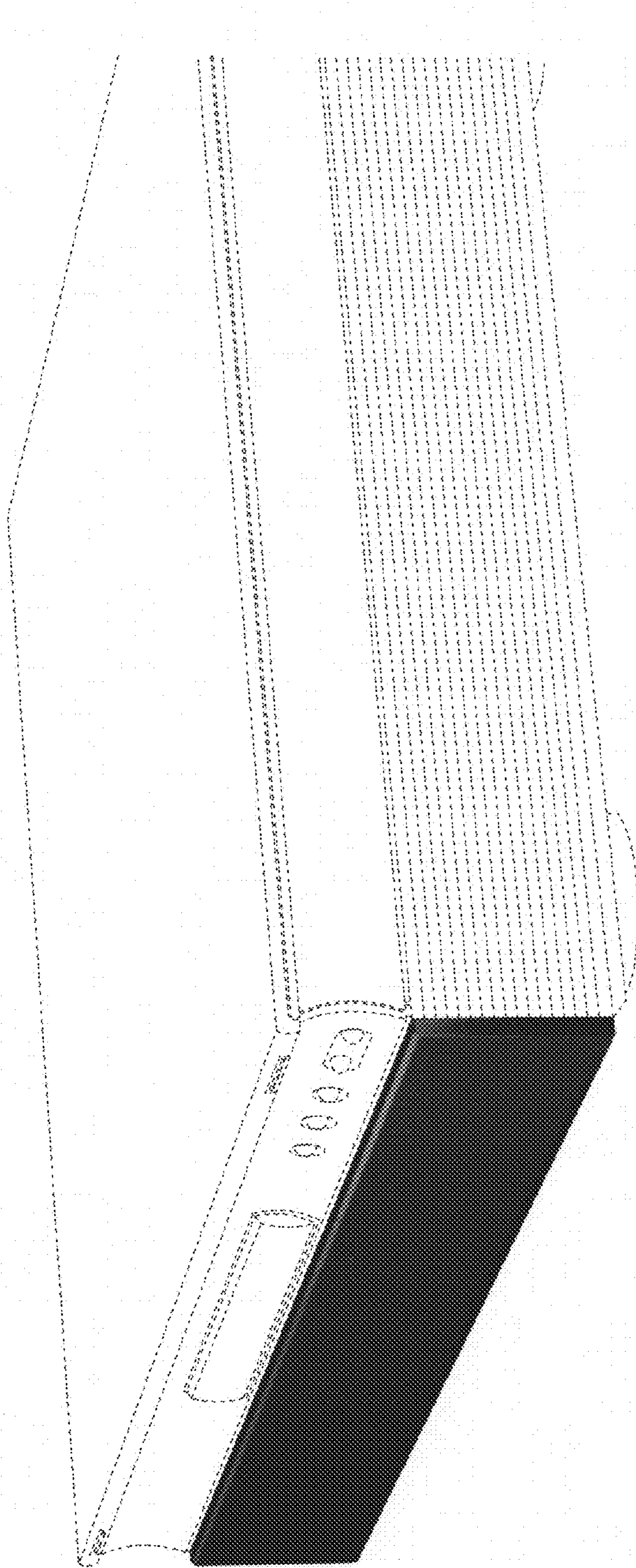

FIG. 6



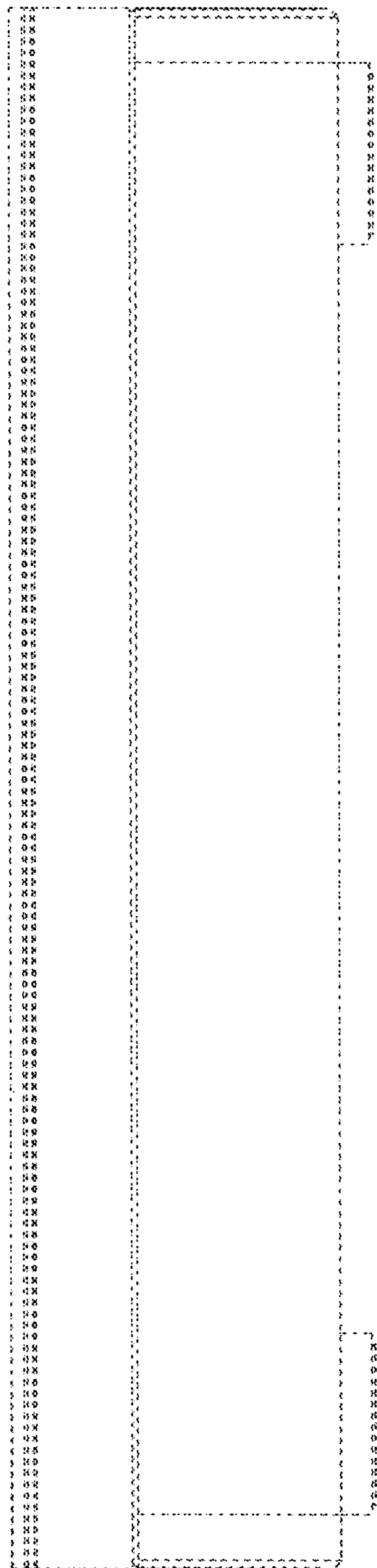

FIG.7

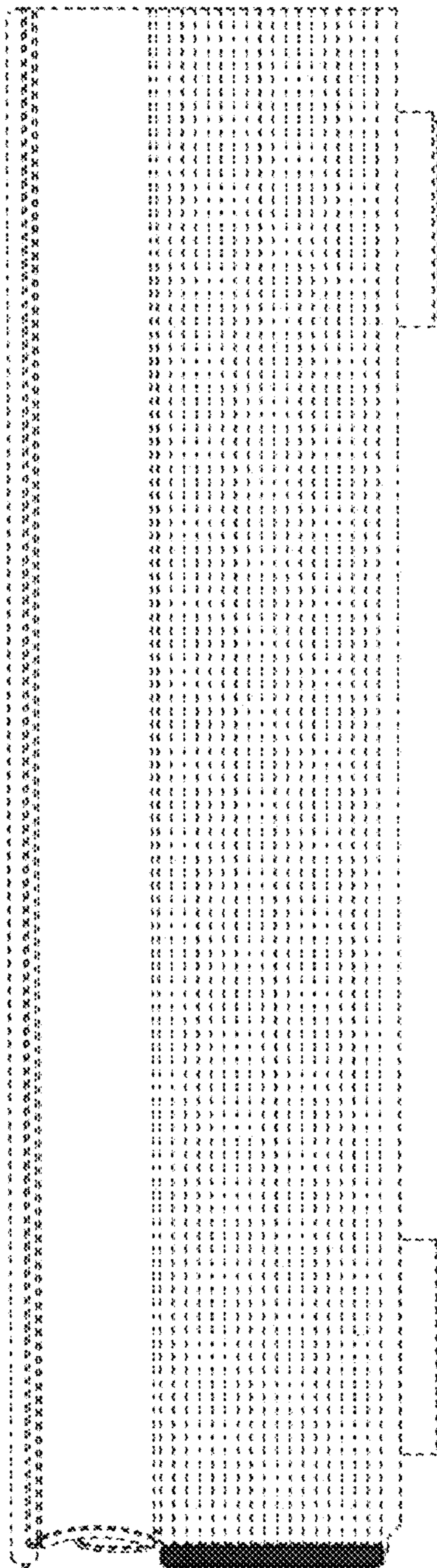

FIG. 8

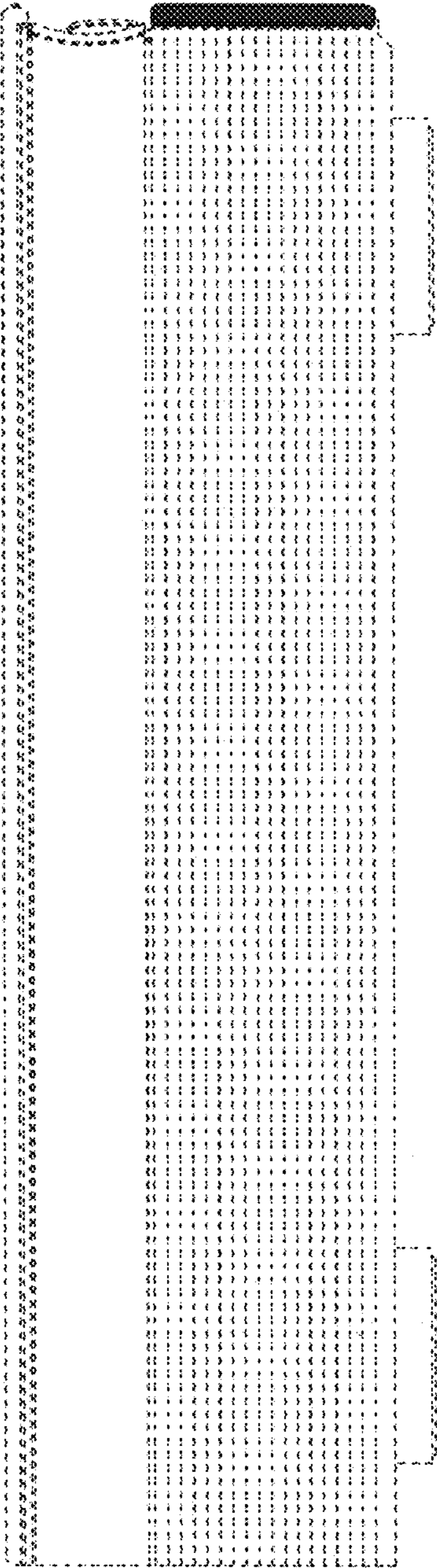

FIG. 9

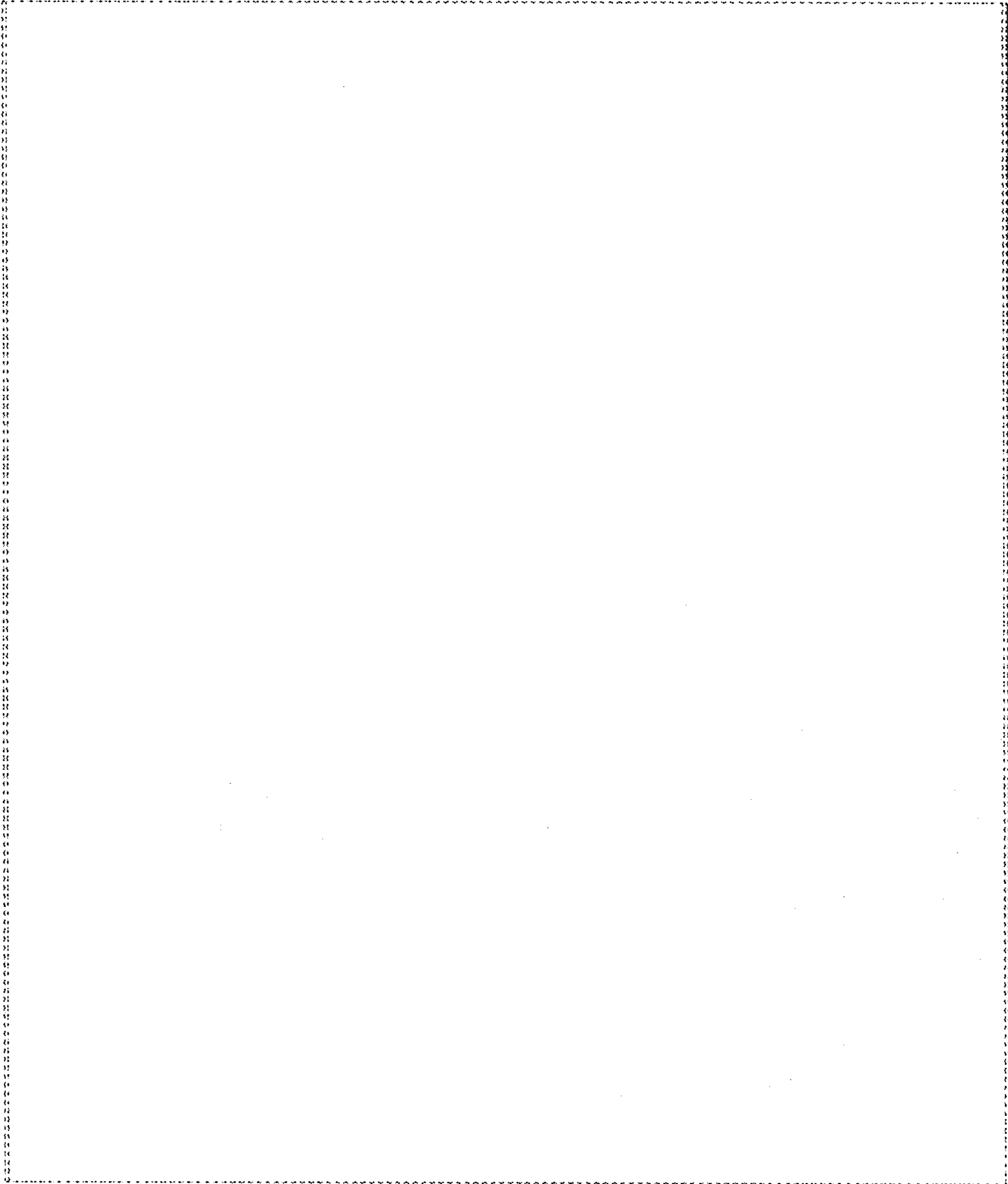

FIG.10

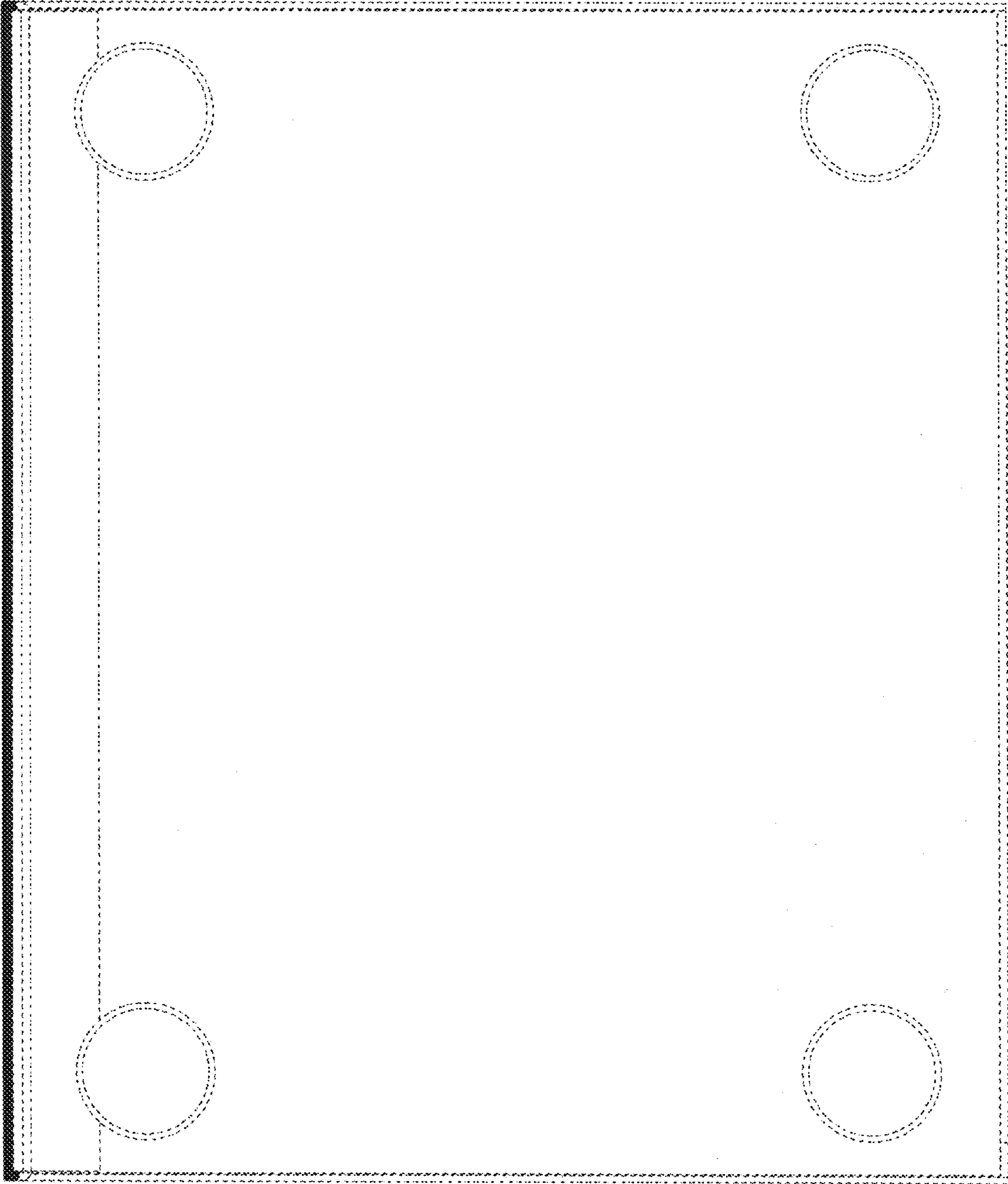

FIG.11

FIG.12

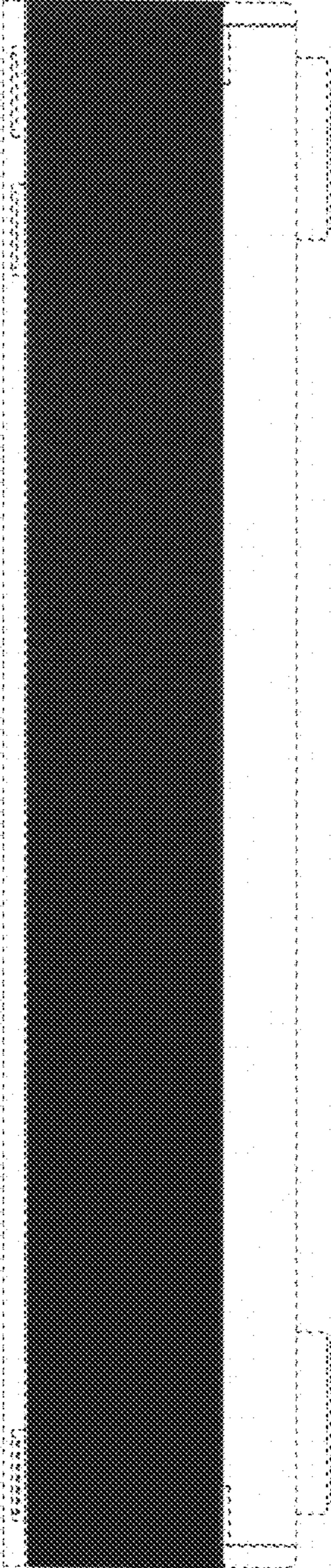

FIG. 13

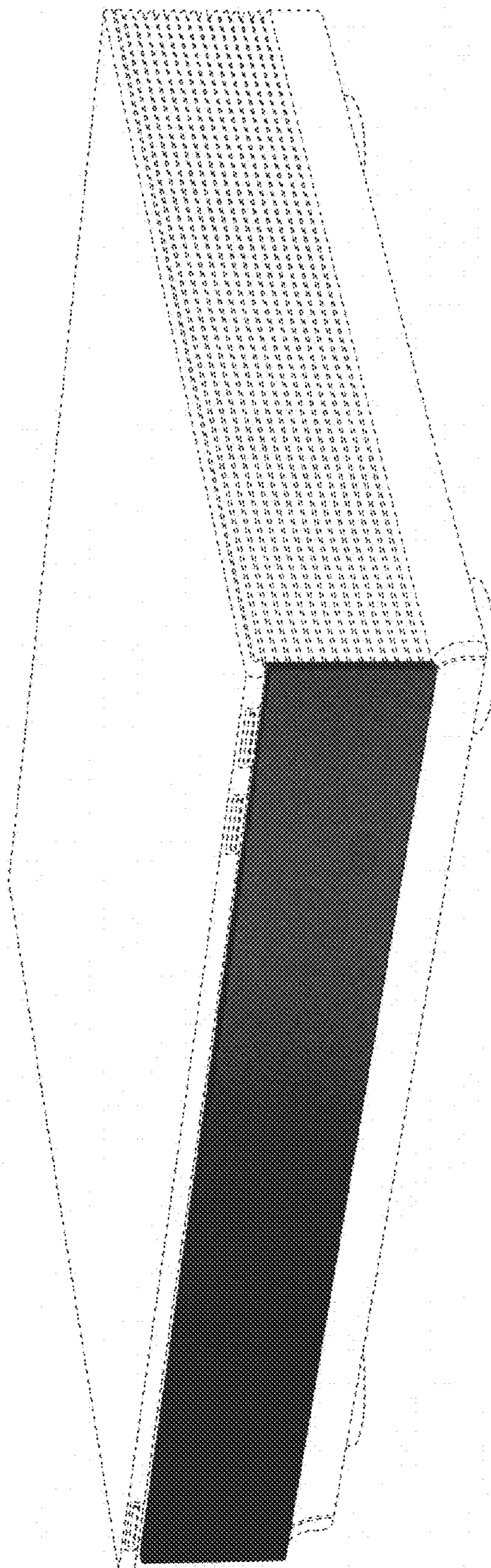

FIG.14

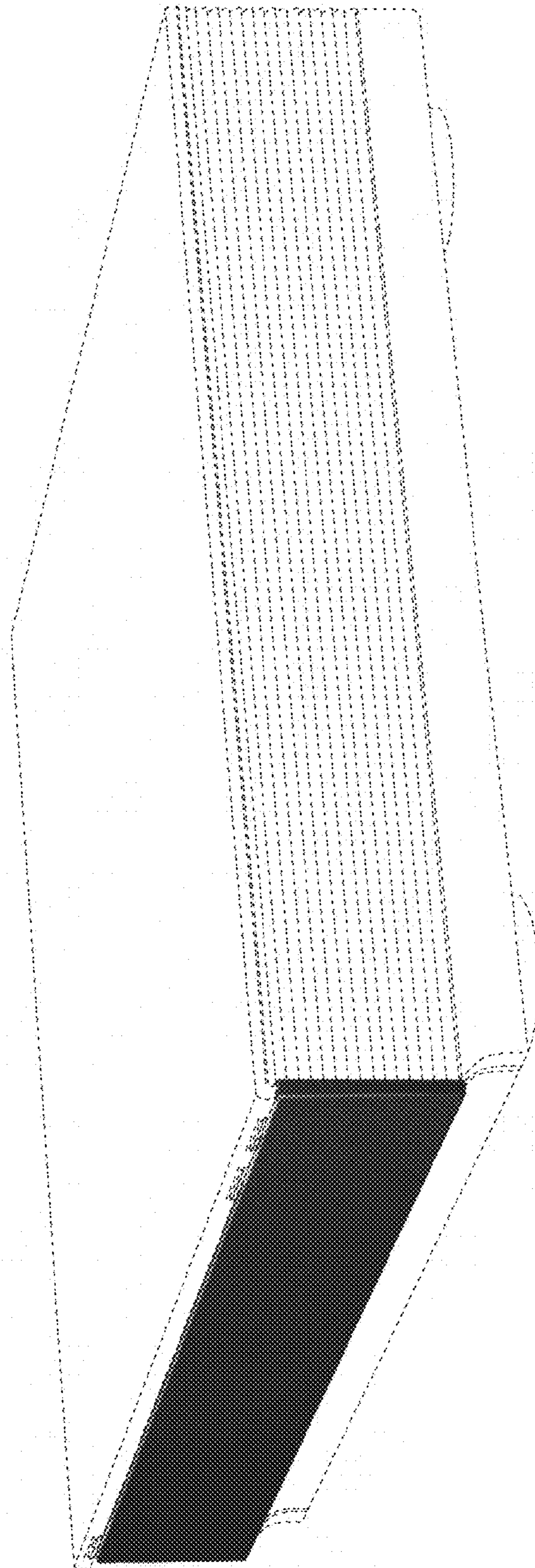

FIG. 15

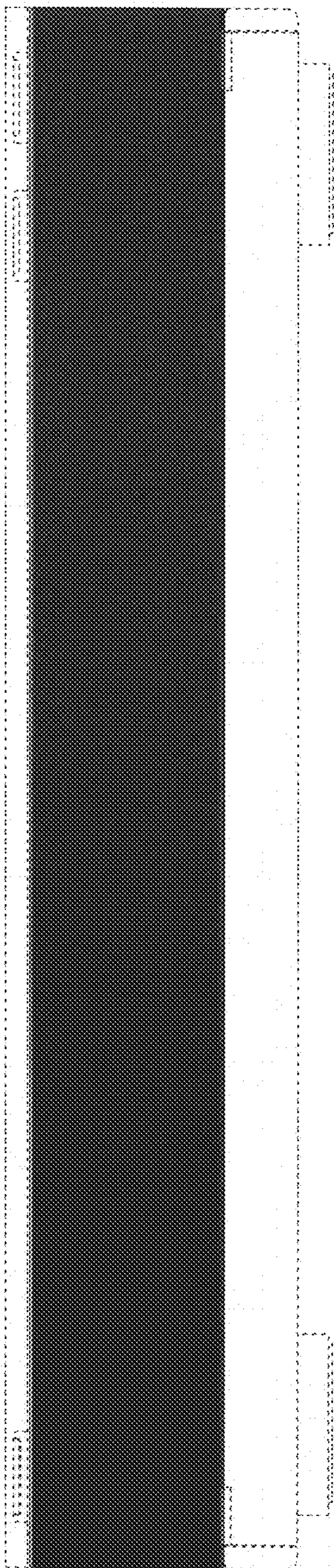

FIG.16

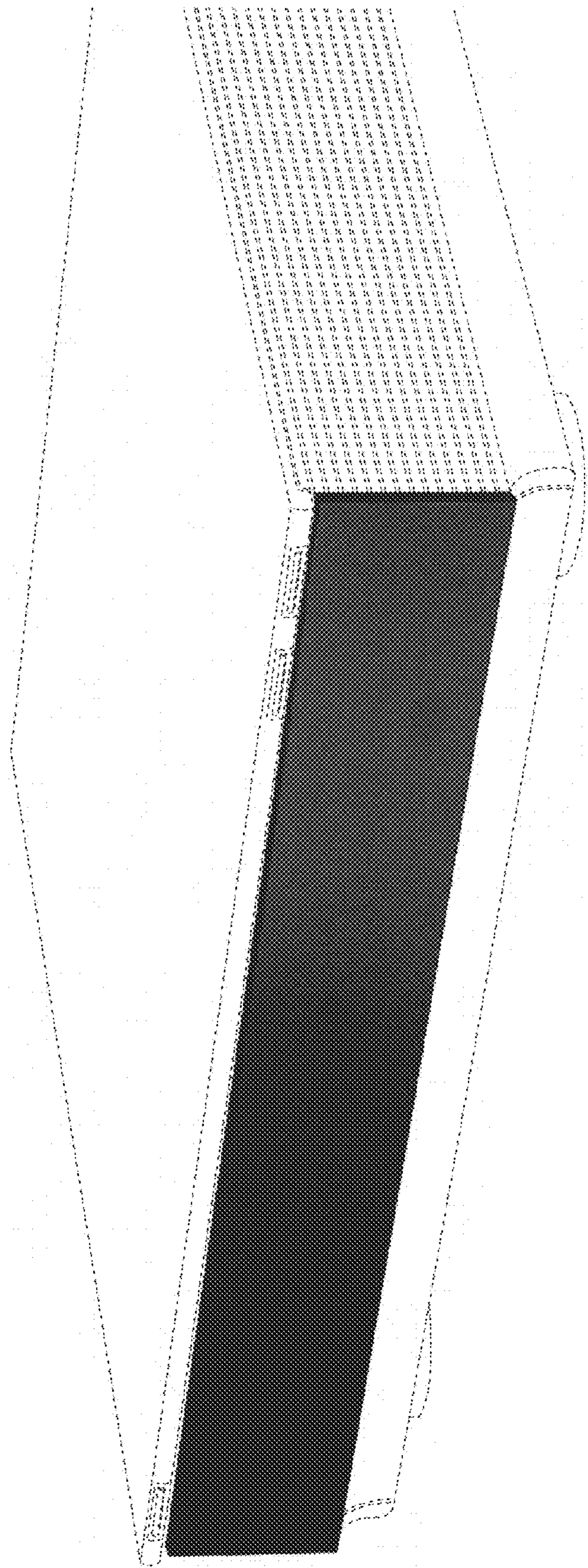

FIG.17

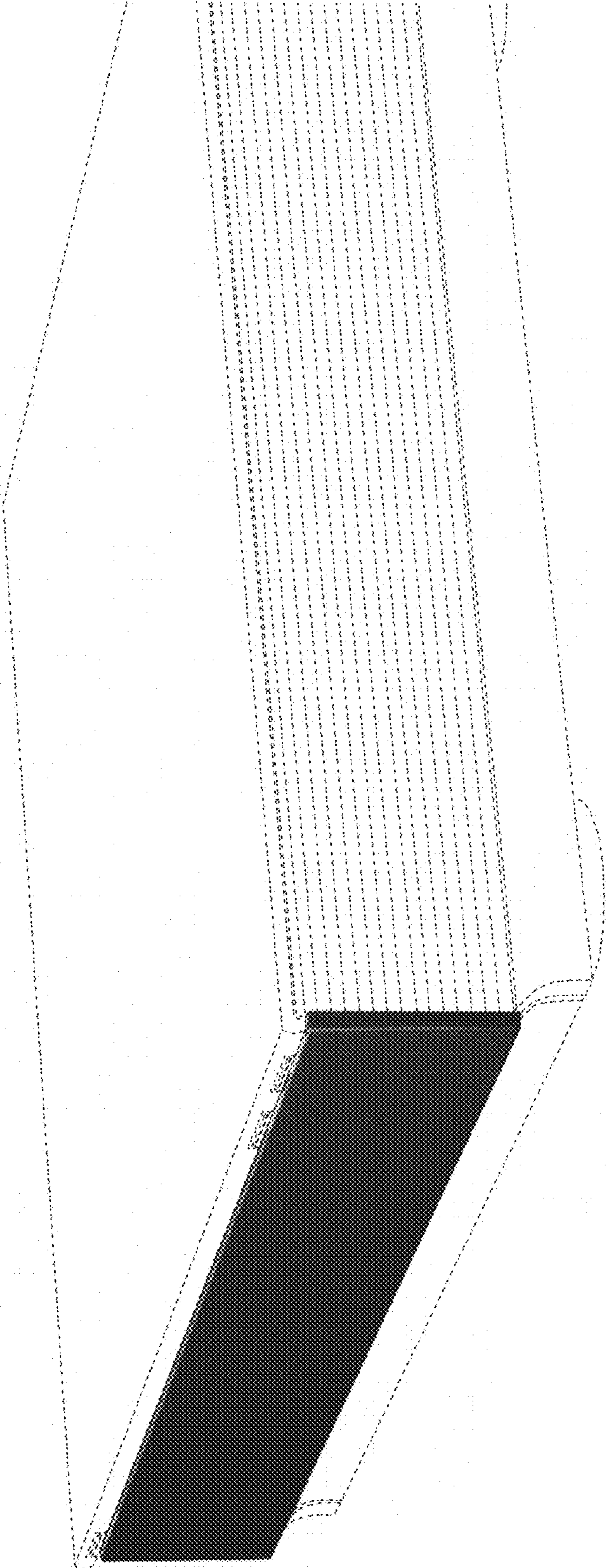

FIG.18

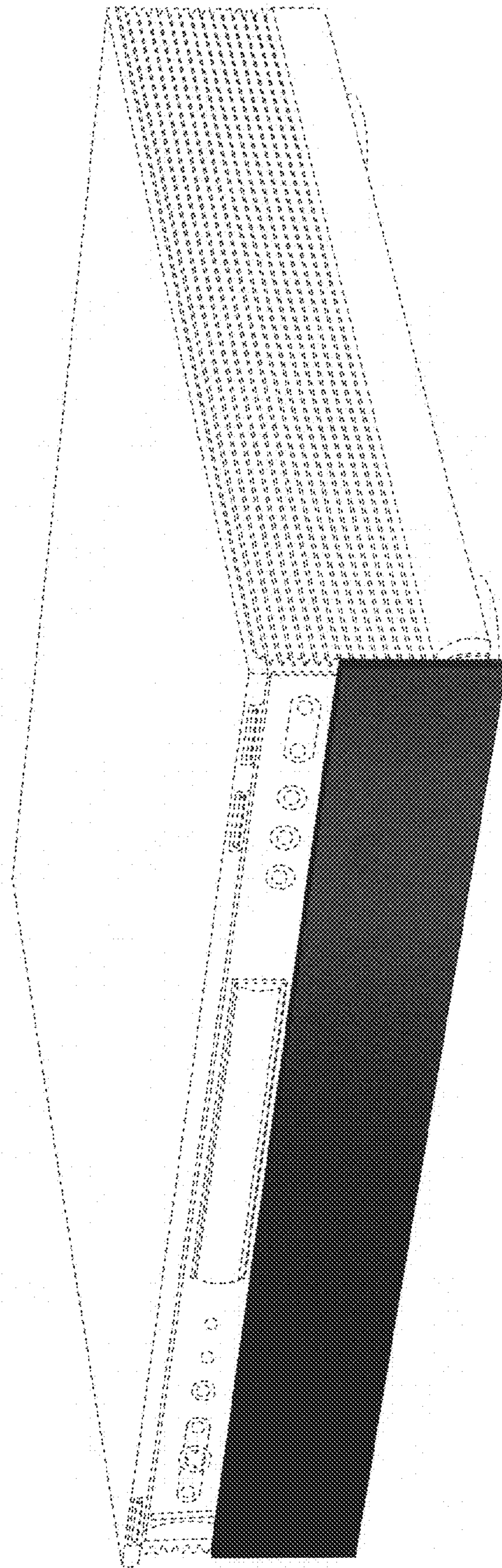
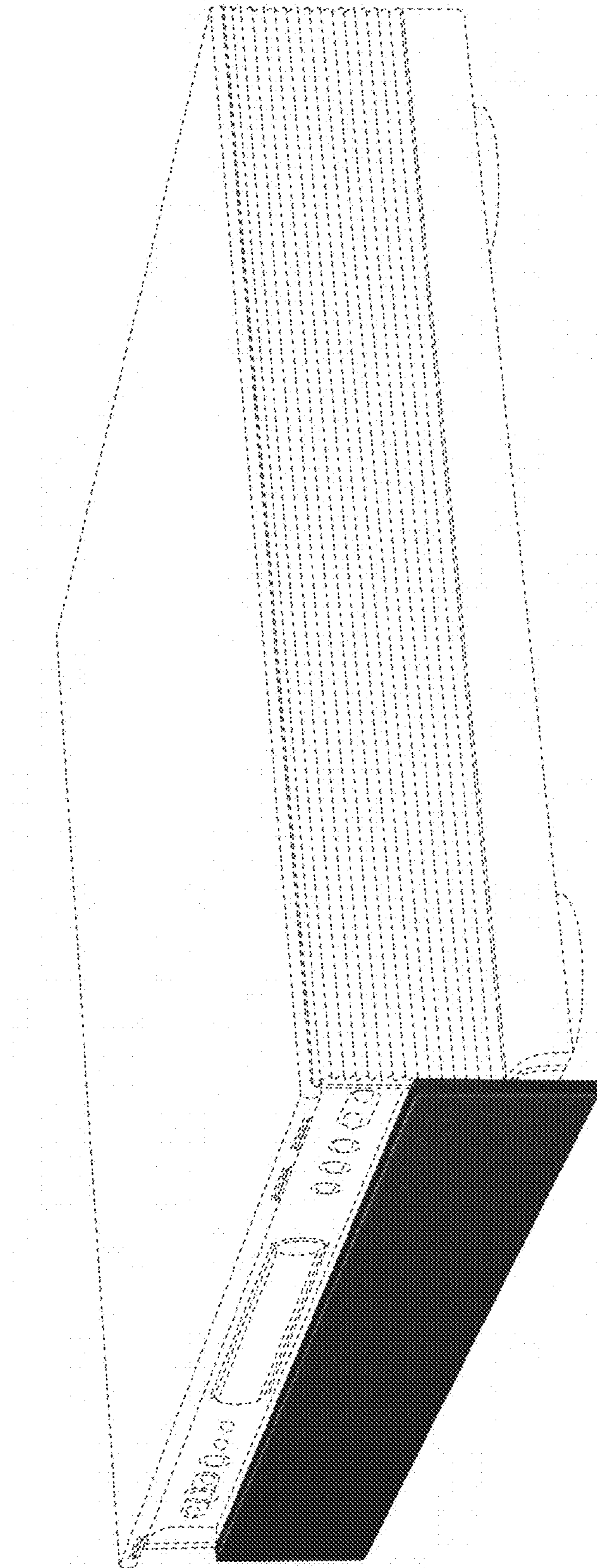

FIG. 19



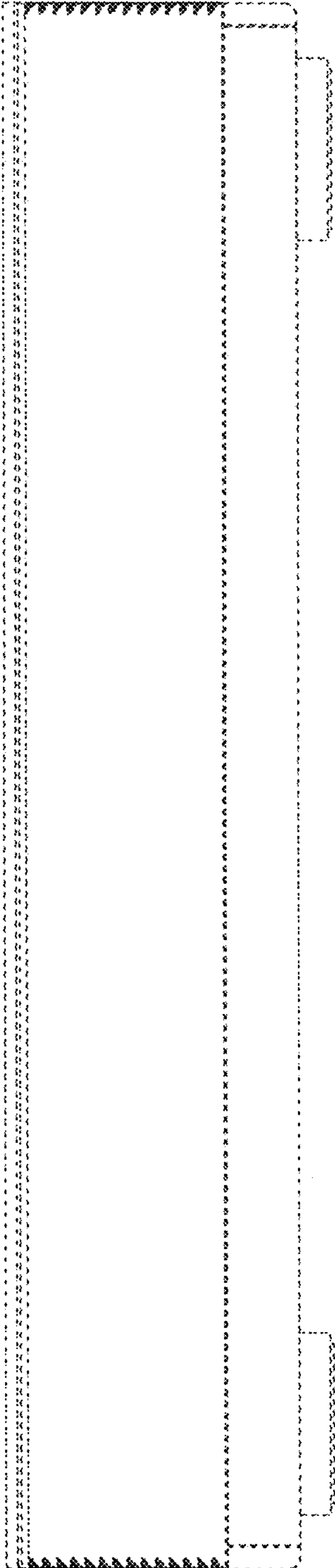

FIG.20

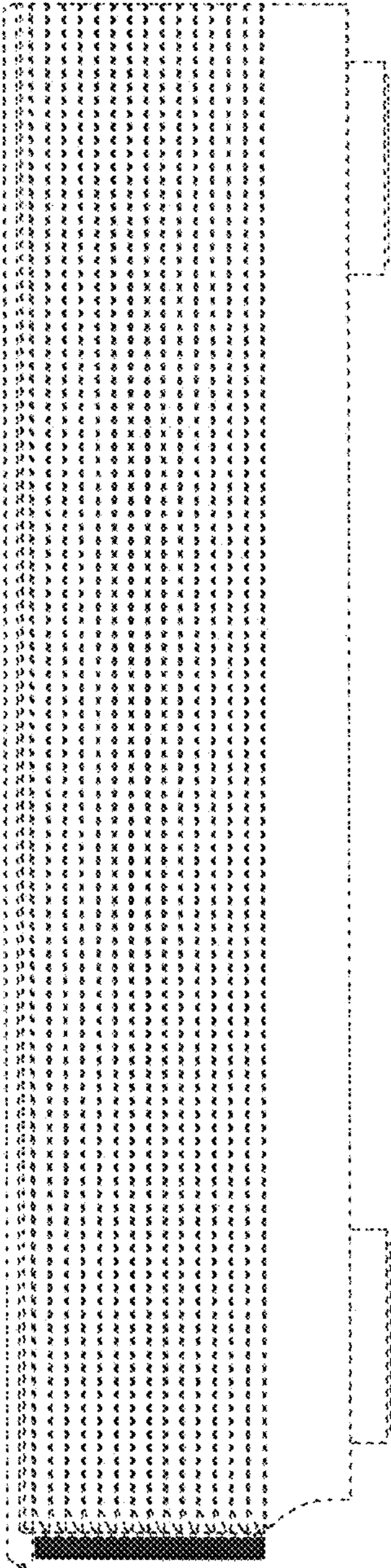

FIG.21

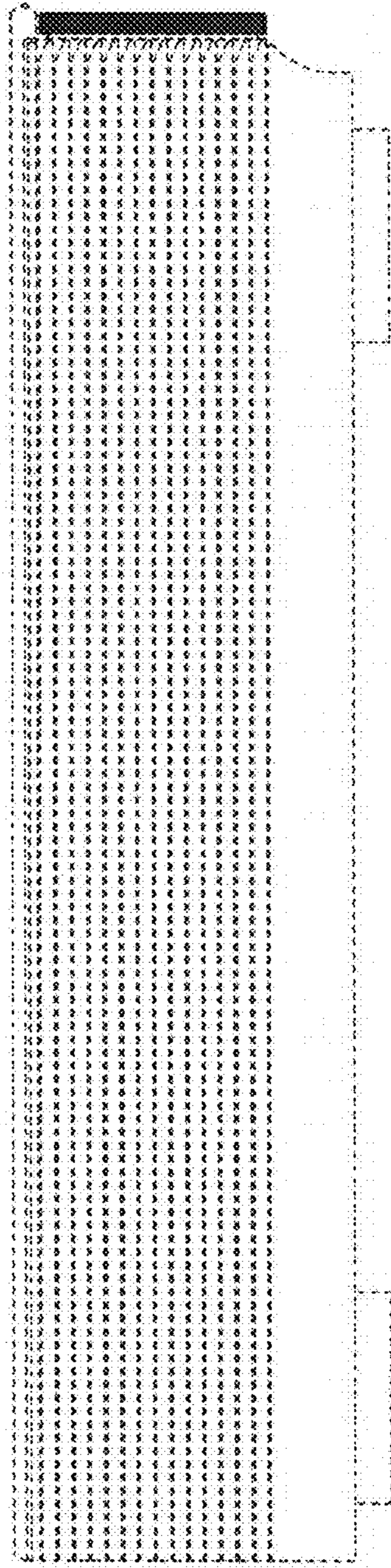

FIG.22

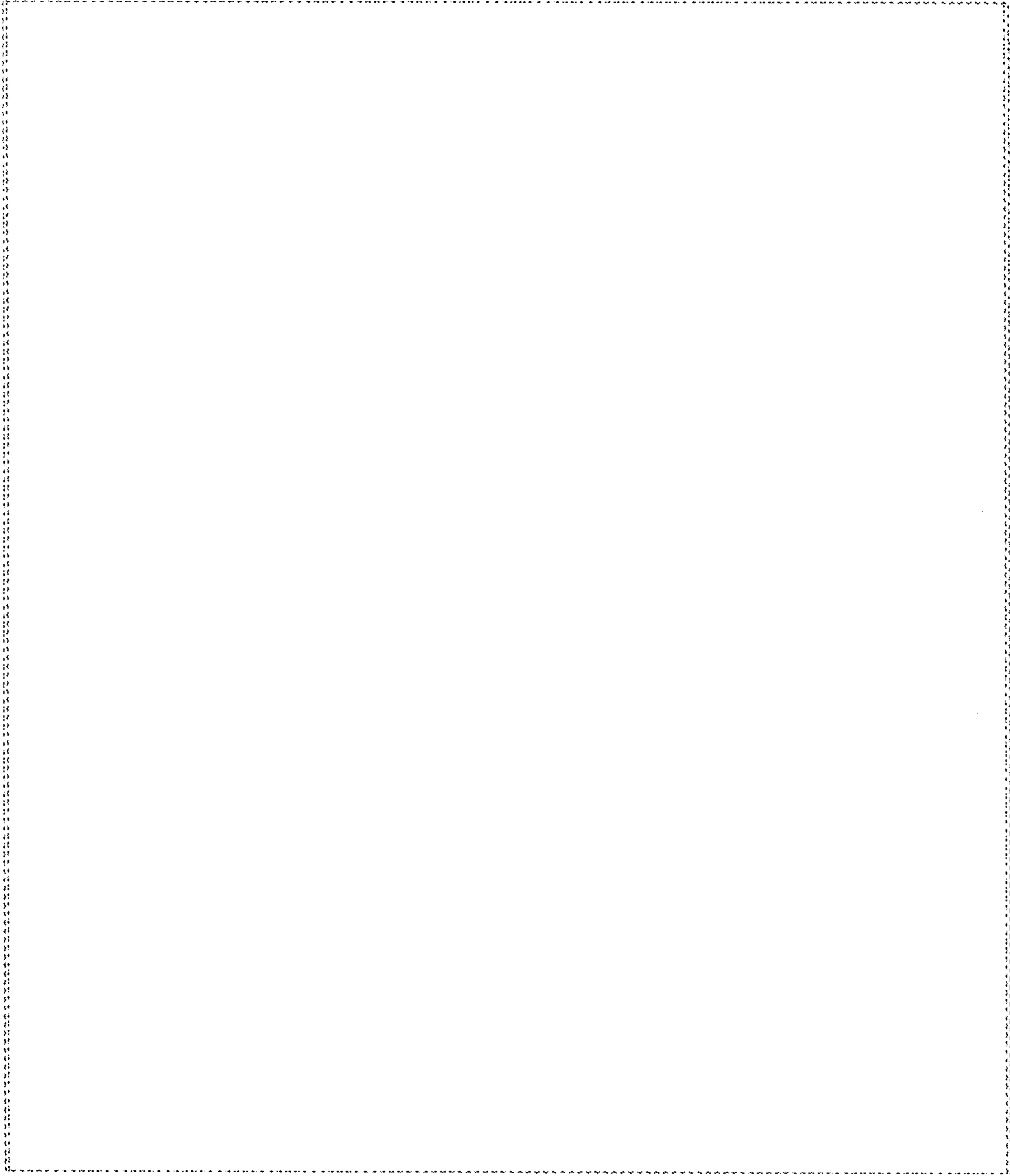

FIG. 23

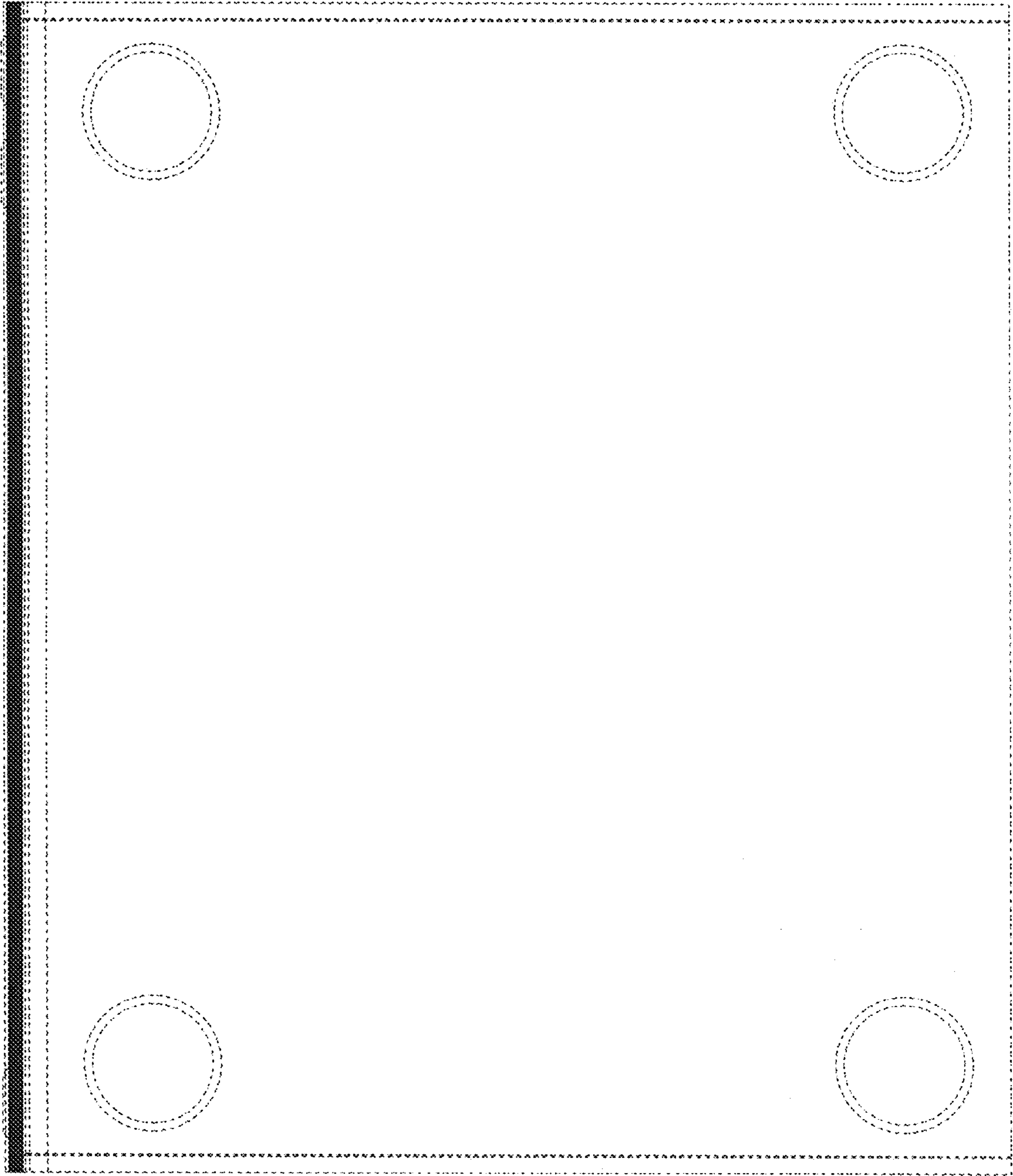
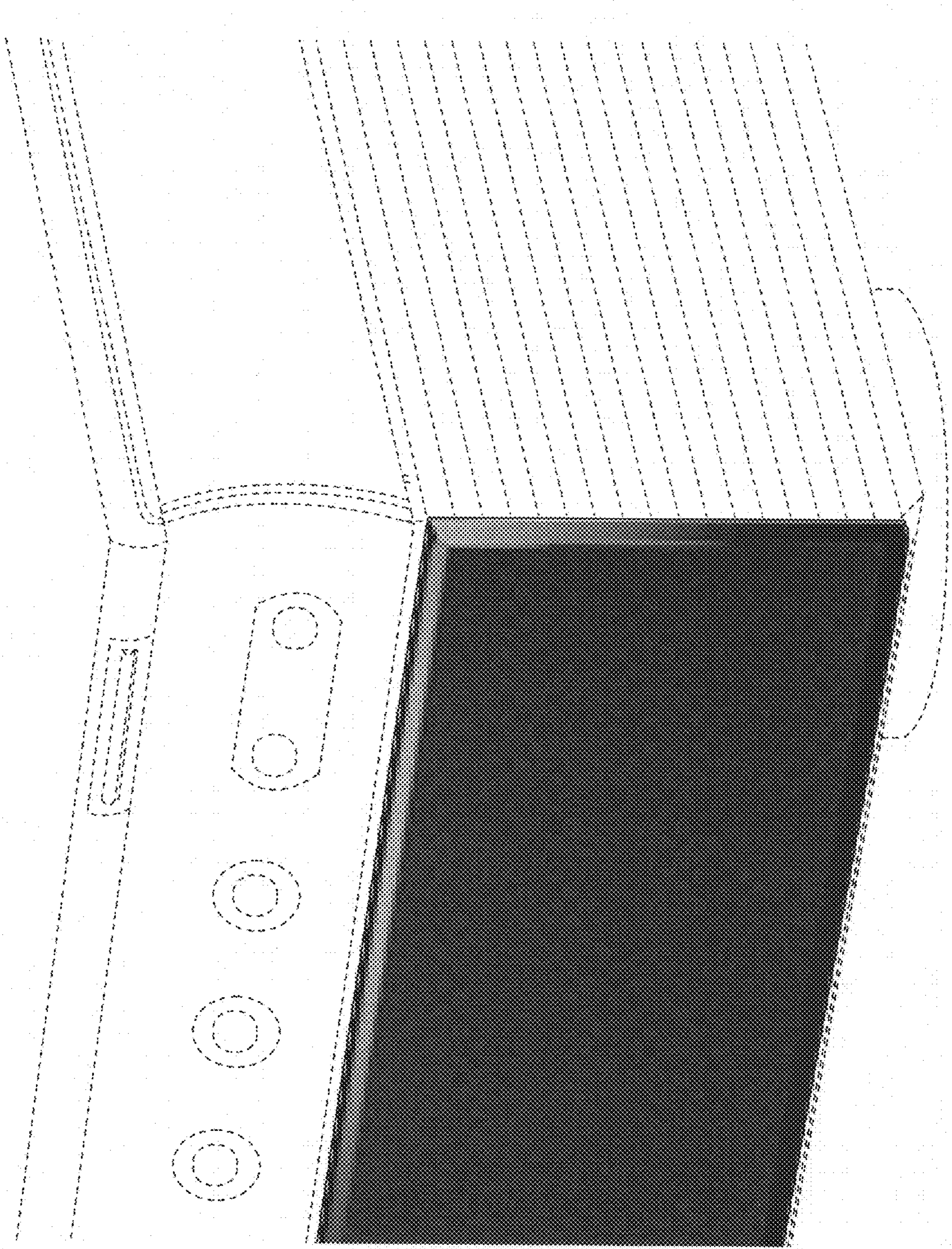

FIG.24

FIG. 25



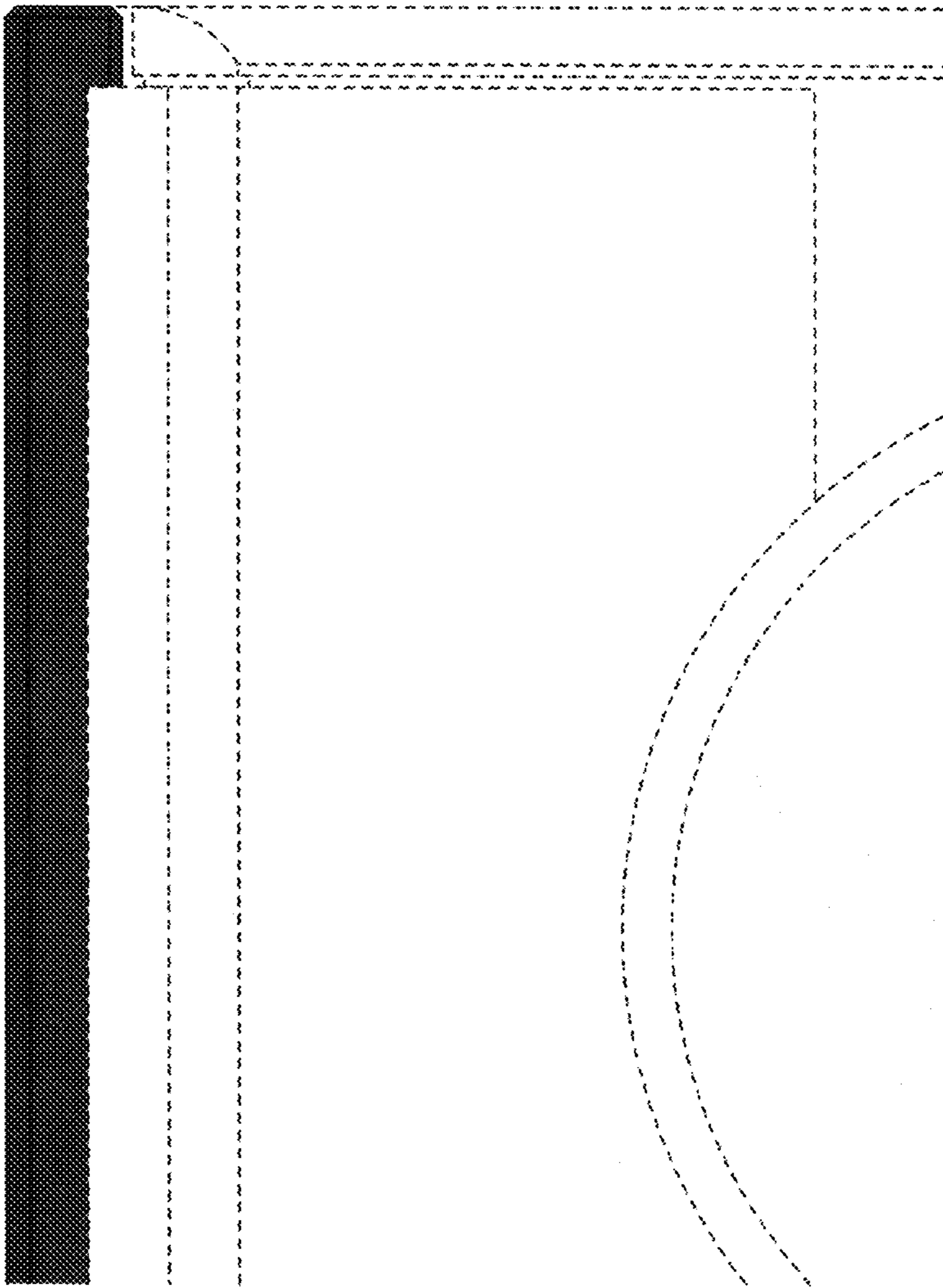
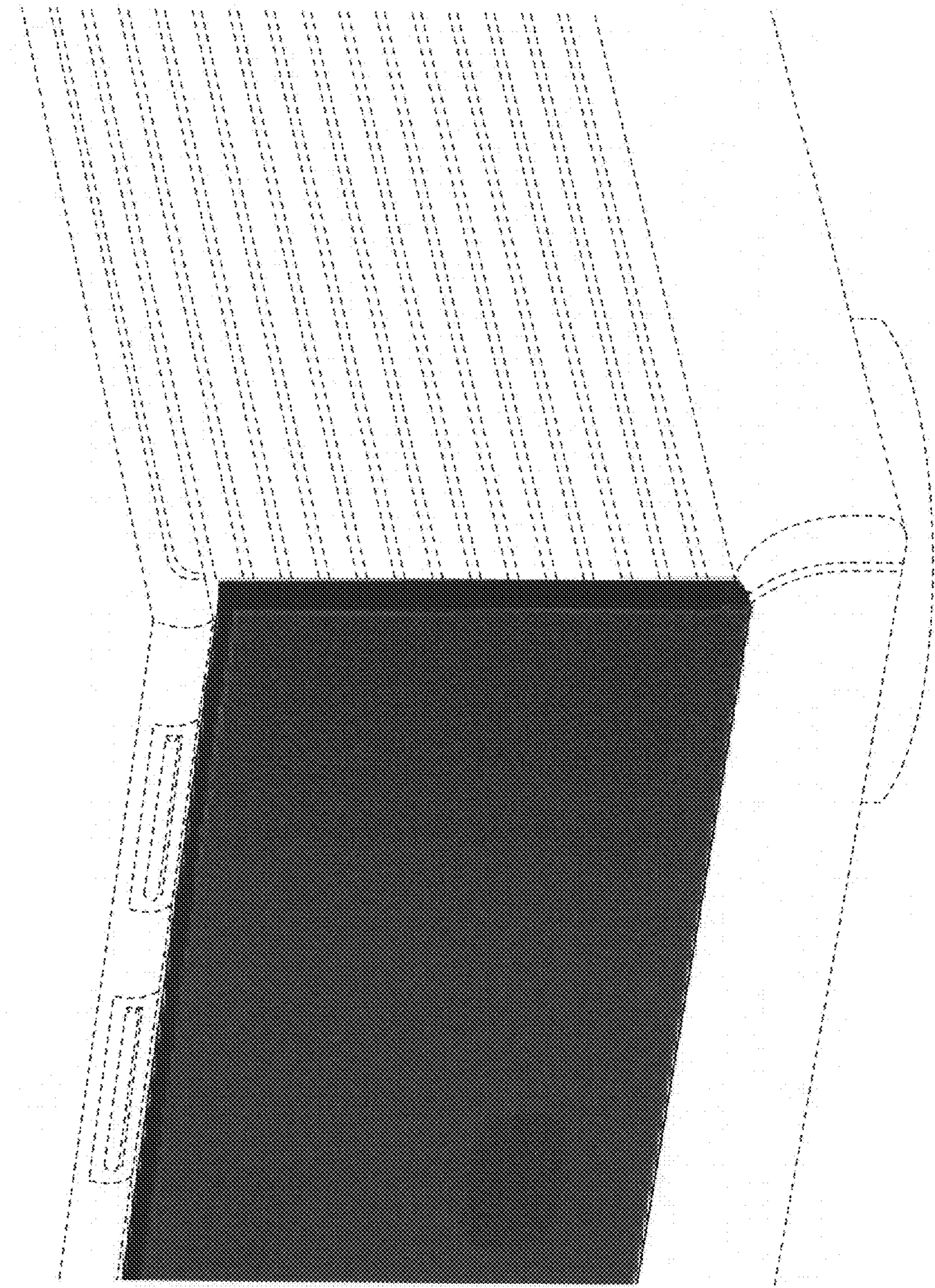

FIG.26

FIG.27



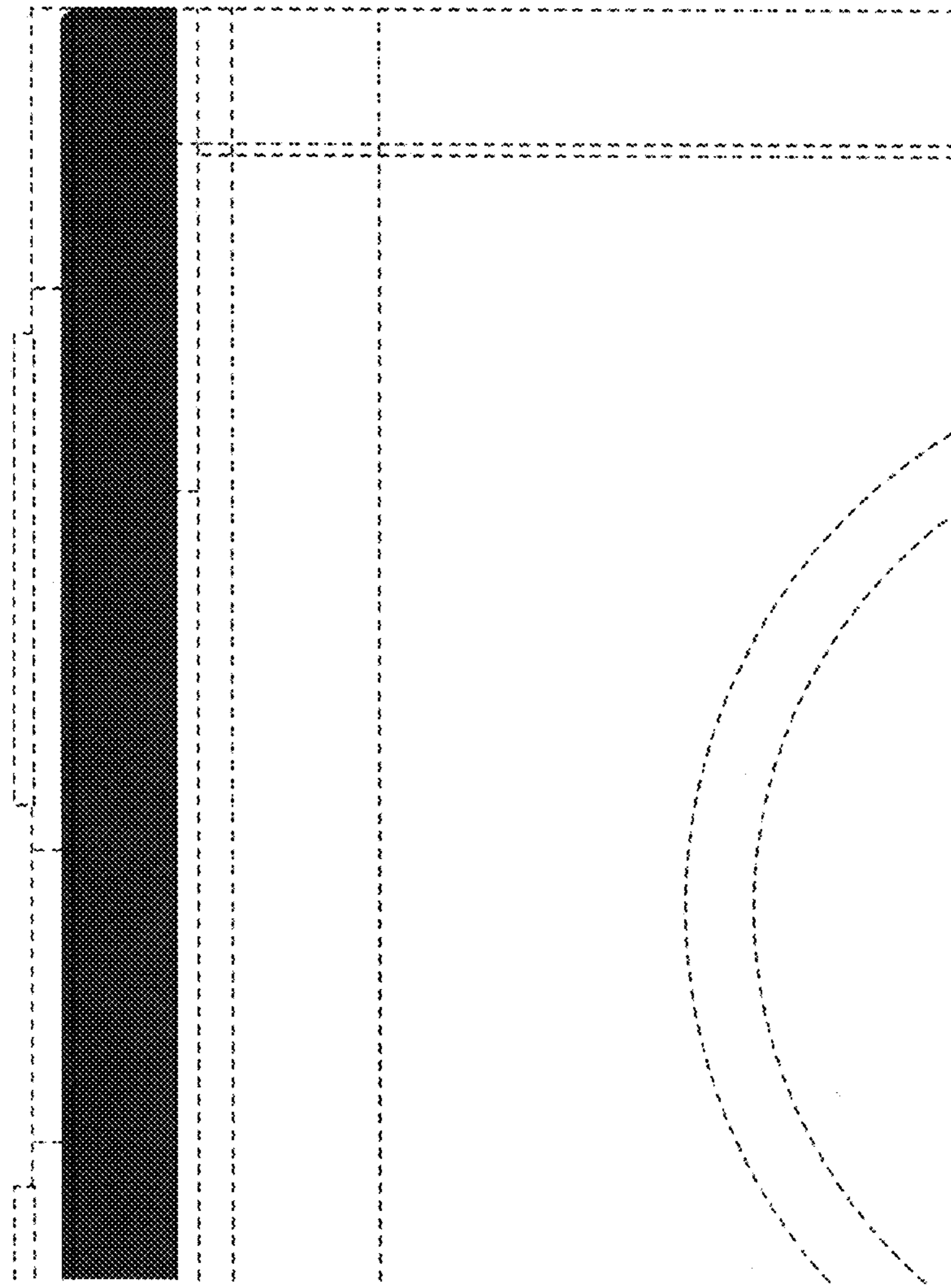

FIG.28