



US00D619041S

(12) **United States Design Patent**
Gaudron et al.

(10) **Patent No.:** **US D619,041 S**
(45) **Date of Patent:** **** Jul. 6, 2010**

(54) **SAFETY PIN**

D465,175 S * 11/2002 Intag D11/214
D586,691 S * 2/2009 Snell D11/214

(75) Inventors: **Paul Gaudron**, Stratford, CT (US);
Jacob Olsen, Roselle, IL (US)

* cited by examiner

(73) Assignee: **Powers Fasteners, Inc.**, Brewster, NY
(US)

Primary Examiner—Ralf Seifert
(74) *Attorney, Agent, or Firm*—Cantor Colburn LLP

(**) Term: **14 Years**

(57) **CLAIM**

(21) Appl. No.: **29/341,715**

I claim, the ornamental design for a safety pin, as shown and described.

(22) Filed: **Aug. 11, 2009**

DESCRIPTION

(51) **LOC (9) Cl.** **02-07**

(52) **U.S. Cl.** **D11/200; D11/214**

(58) **Field of Classification Search** D11/1-2,
D11/200-201, 203-206, 210, 212, 214-219,
D11/222, 224, 226; 24/163 R, 169-171,
24/173, 177-179, 191, 194-195, 197, 200,
24/710, 708.5

FIG. 1 is a front perspective view of the safety pin;
FIG. 2 is a rear perspective view of the safety pin,
FIG. 3 is a rear view of the safety pin;
FIG. 4 is a front view of the safety pin;
FIG. 5 is a side view of the safety pin with the opposite side
being a mirror image thereof;
FIG. 6 is a top plan view of the safety pin; and,
FIG. 7 is a bottom plan view of the safety pin.

See application file for complete search history.

(56) **References Cited**

U.S. PATENT DOCUMENTS

D309,280 S * 7/1990 Balfanz-Lee D11/215

1 Claim, 3 Drawing Sheets

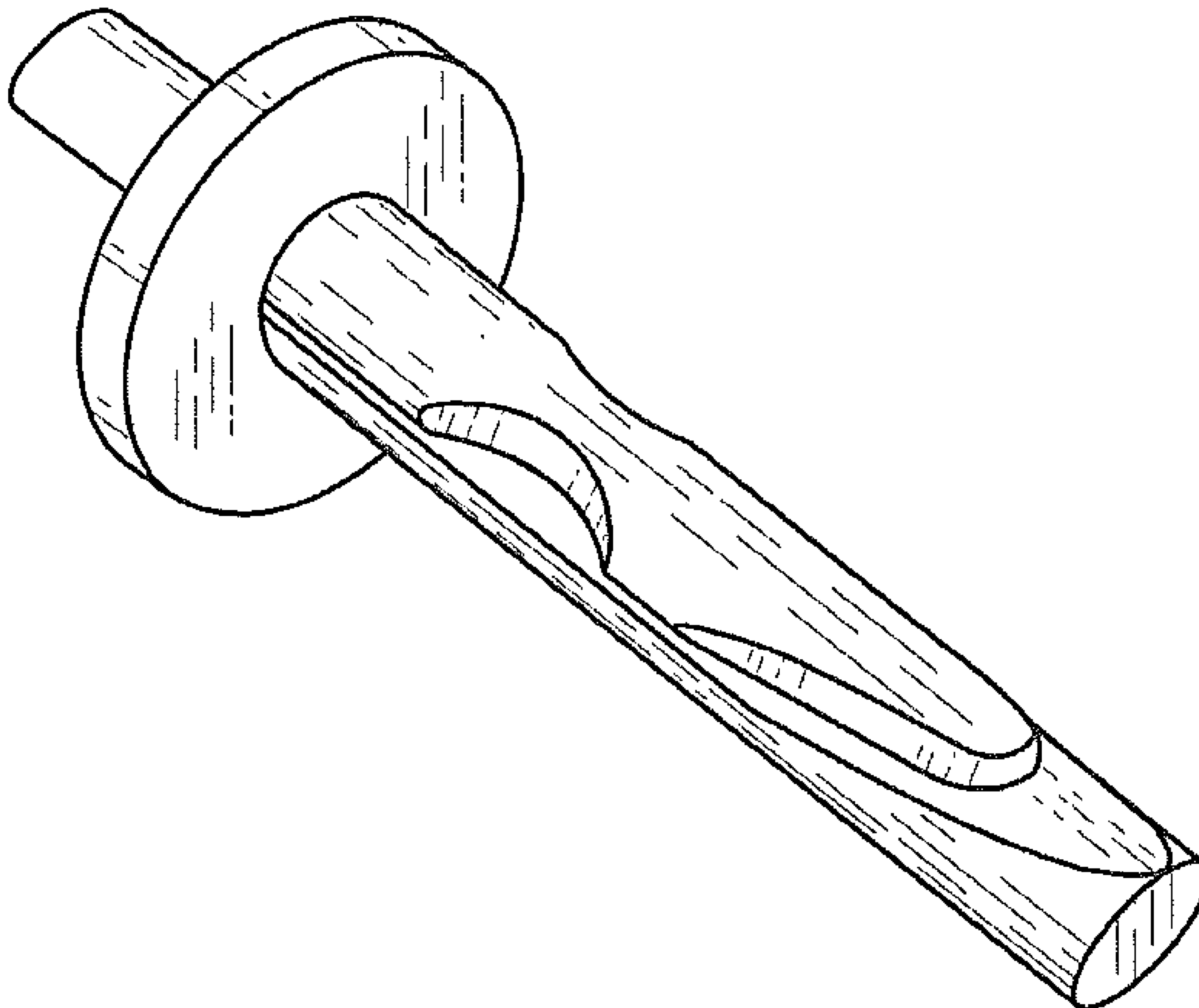

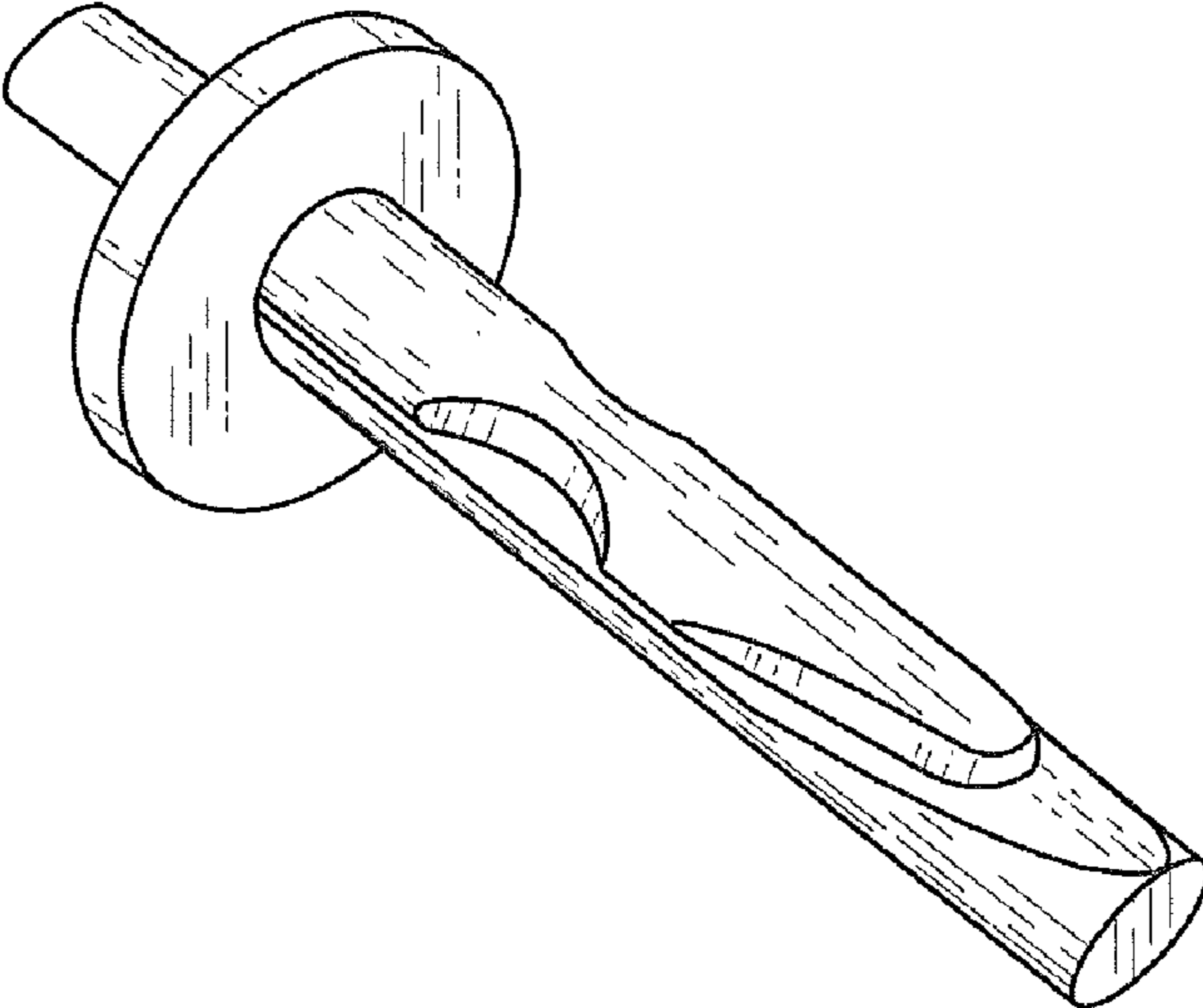

FIG. 1

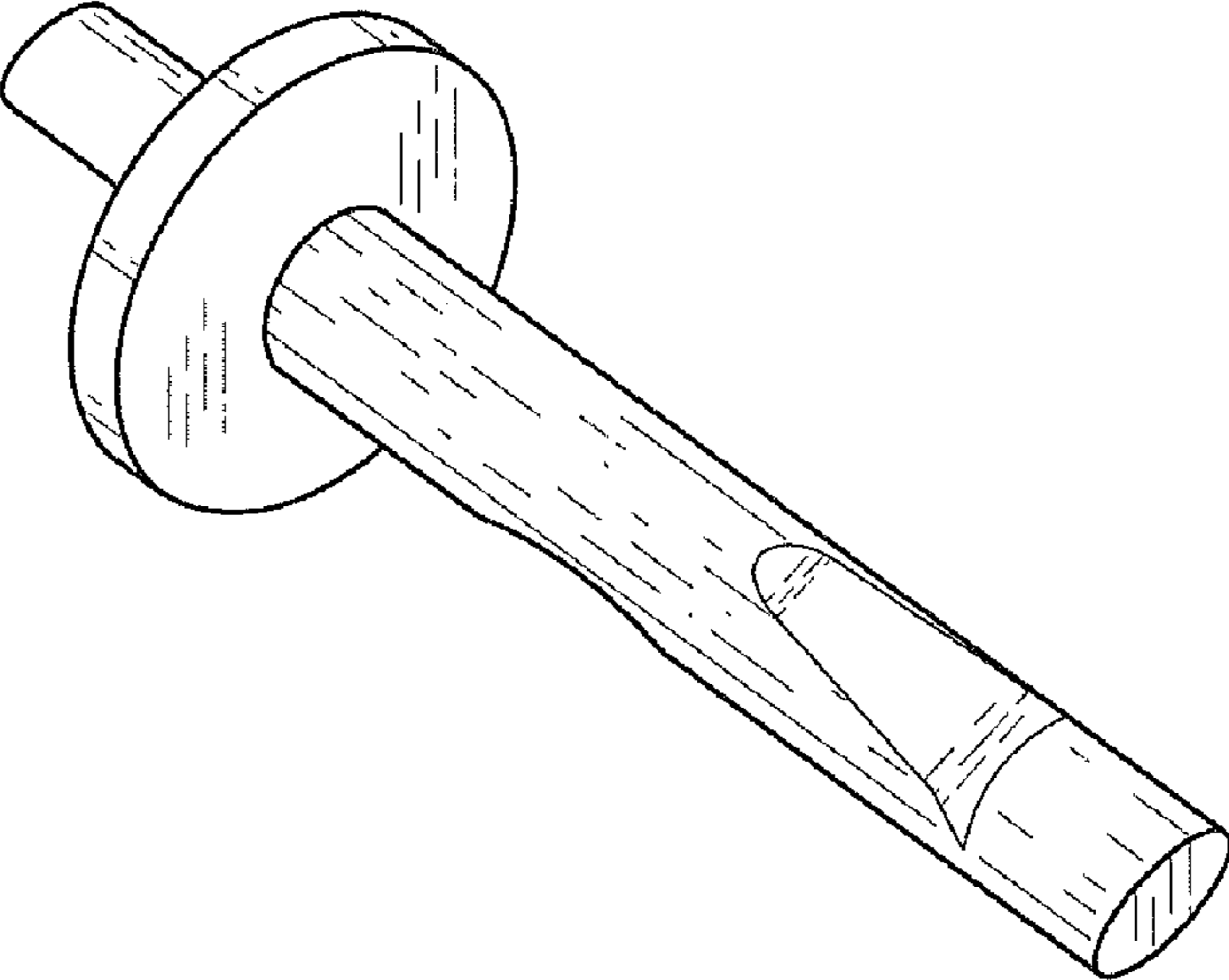

FIG. 2

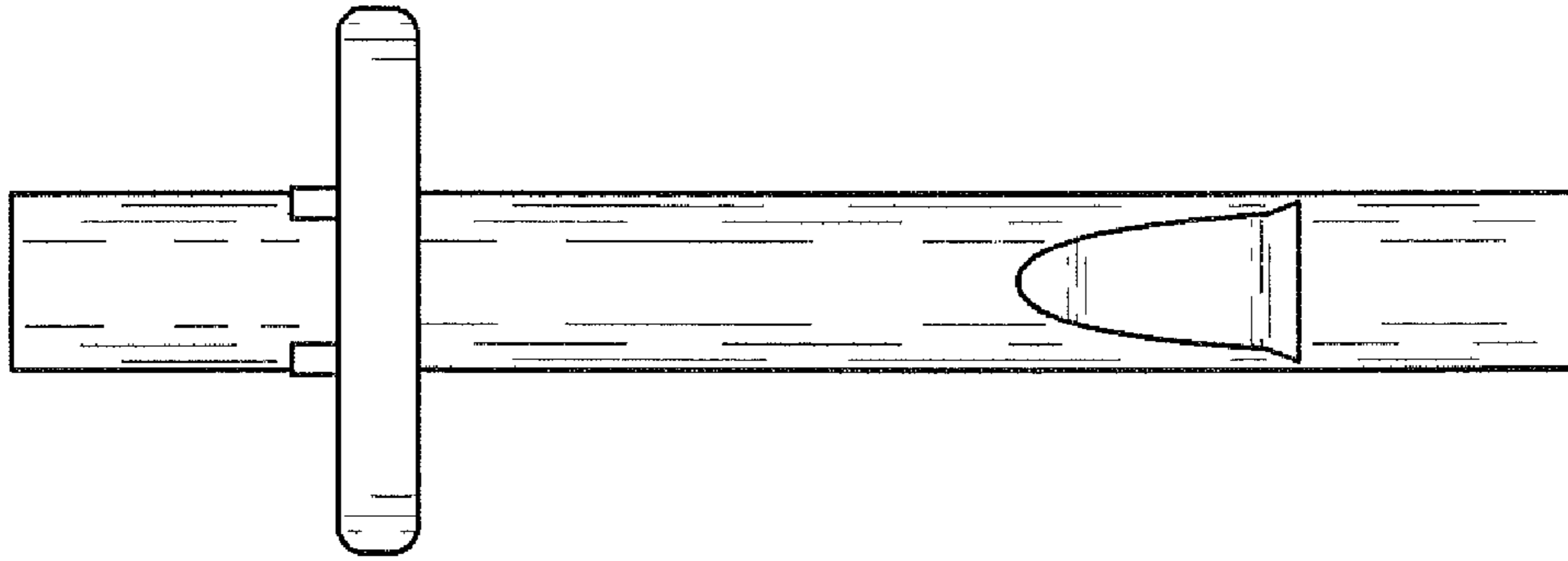

FIG. 3

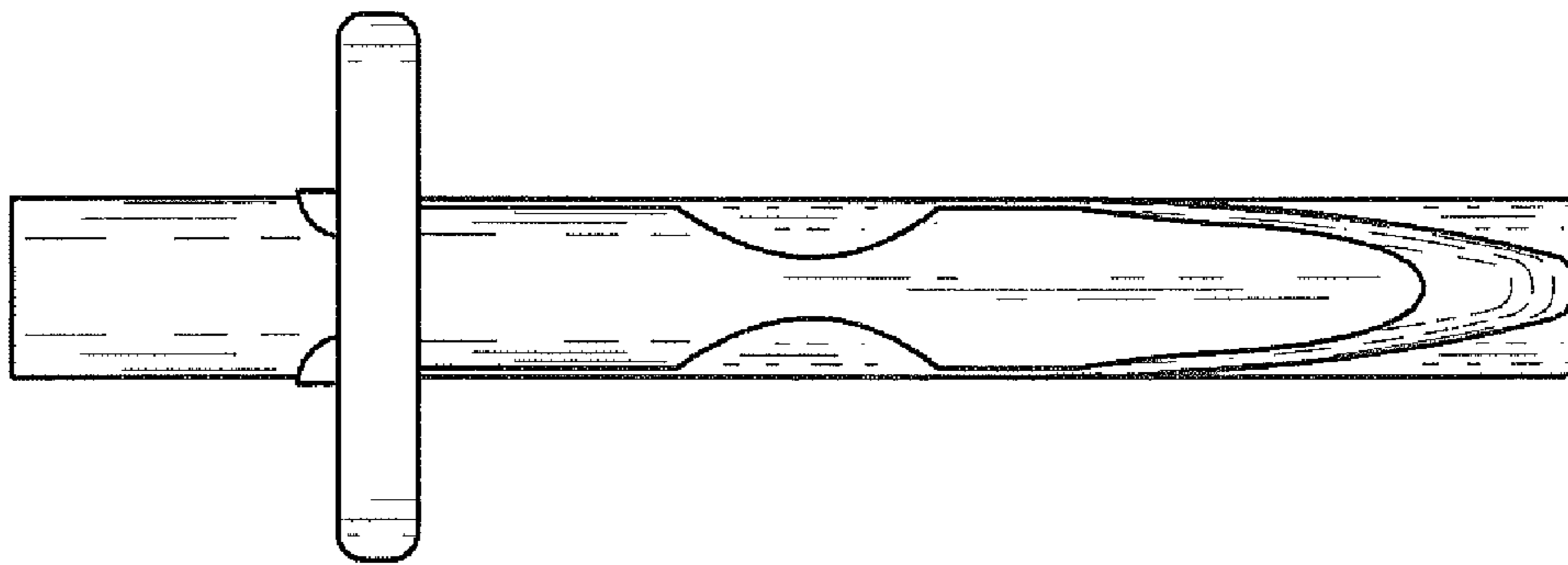

FIG. 4

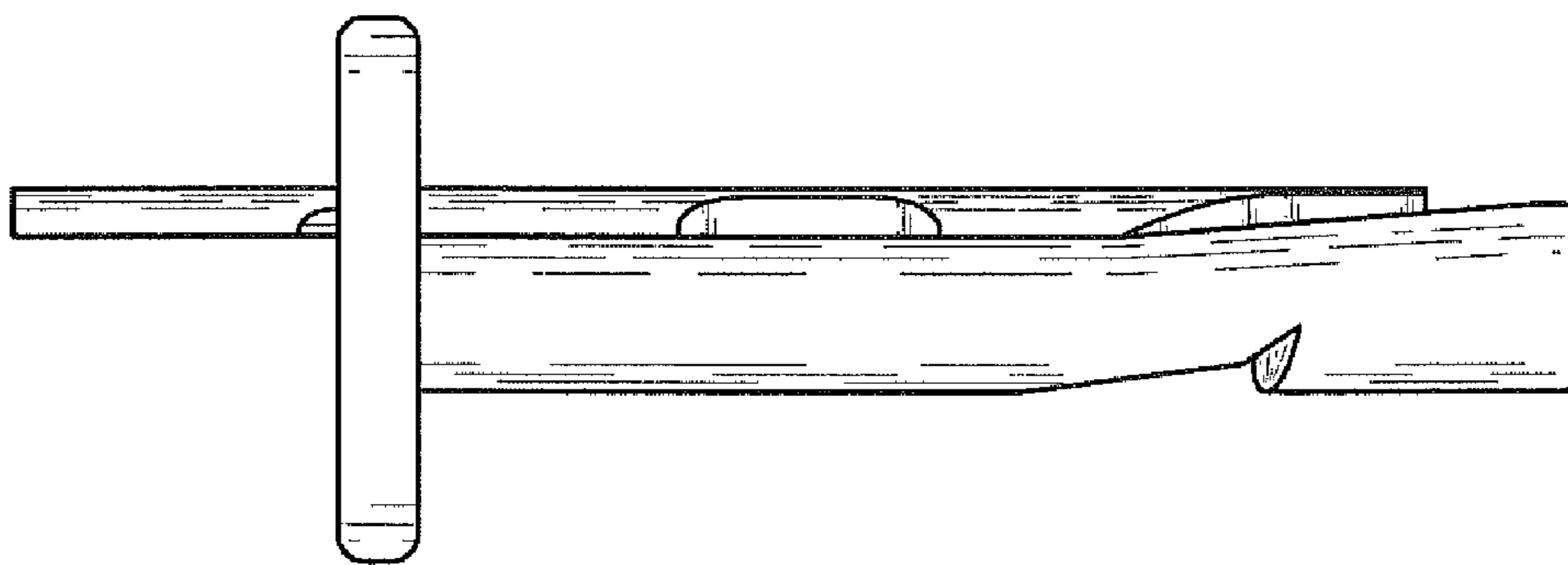

FIG. 5

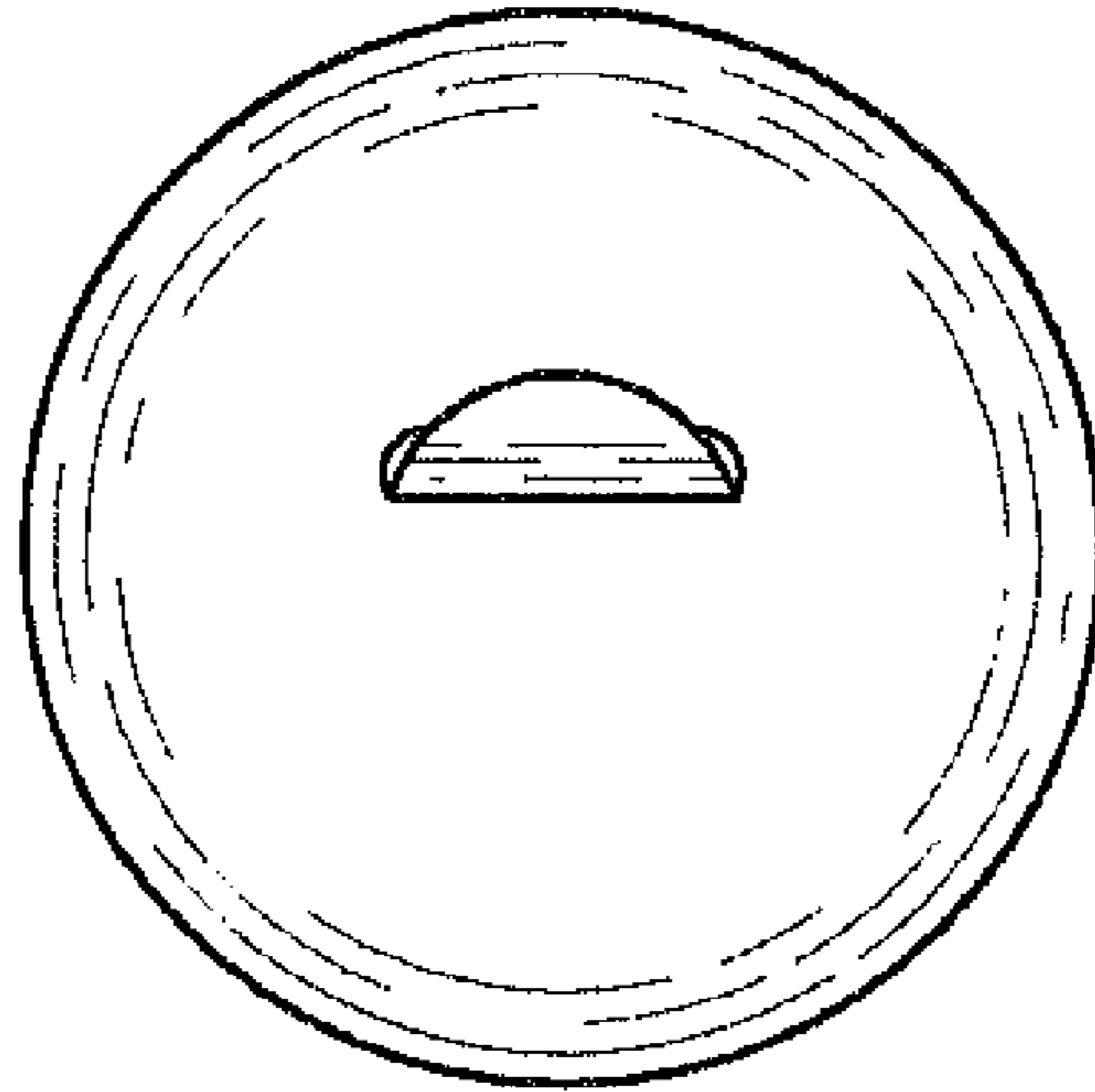

FIG. 6

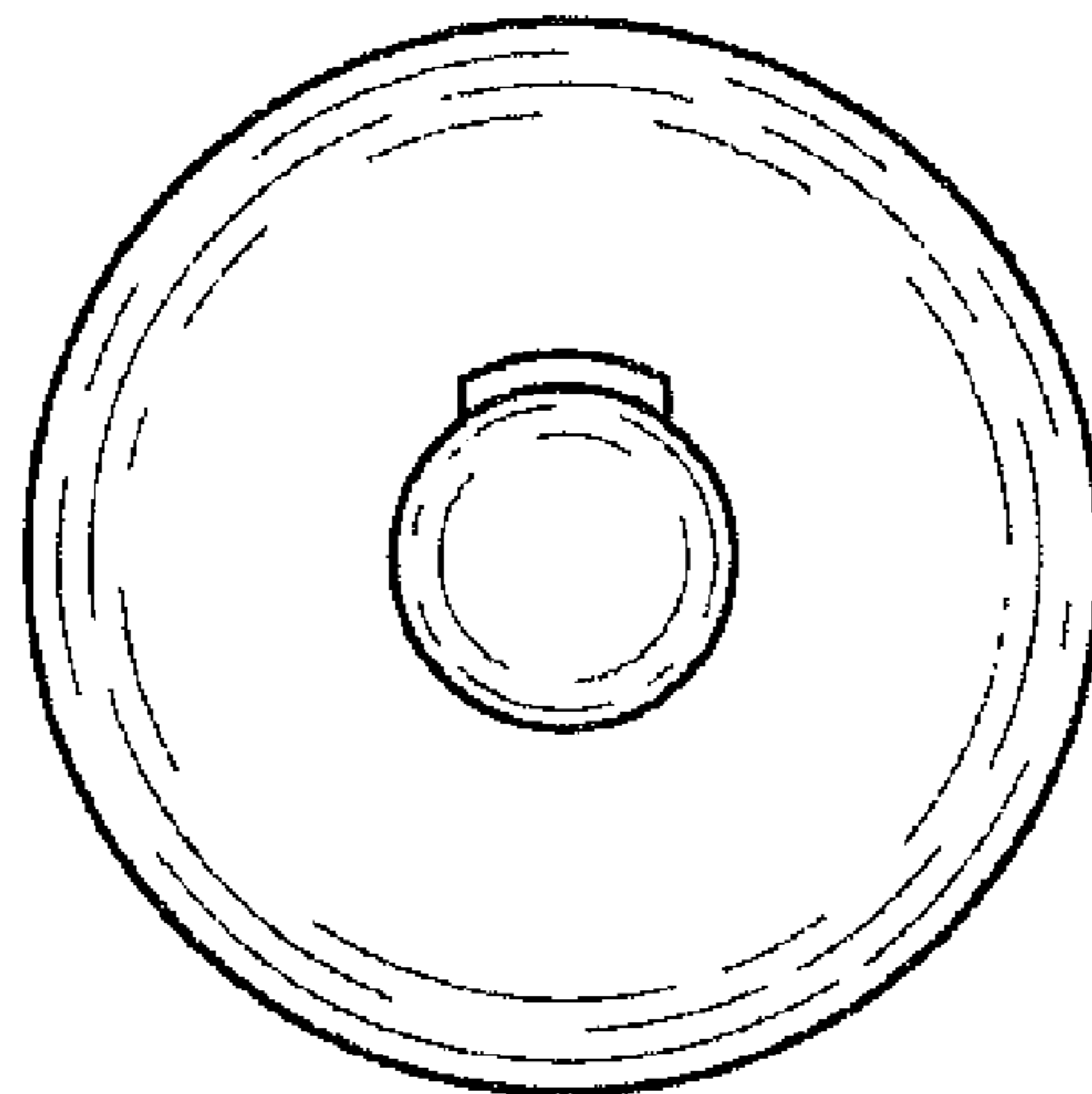

FIG. 7