



US00D619007S

(12) **United States Design Patent**
Brozell

(10) **Patent No.:** **US D619,007 S**

(45) **Date of Patent:** **** Jul. 6, 2010**

(54) **CONTAINER**

(75) Inventor: **Leonora M. Brozell**, Maumee, OH (US)

(73) Assignee: **Rexam Closure Systems Inc.**,
Perrysburg, OH (US)

(**) Term: **14 Years**

(21) Appl. No.: **29/326,035**

(22) Filed: **Oct. 10, 2008**

(51) **LOC (9) Cl.** **09-01**

(52) **U.S. Cl.** **D9/522; D9/529; D9/449**

(58) **Field of Classification Search** D9/682,
D9/686, 693-694, 522-523, 529-530, 542-543,
D9/549, 575, 414, 424, 444-446, 449; D3/273;
D28/7, 91; 215/382-384, 400; 220/660,
220/662, 669

See application file for complete search history.

(56) **References Cited**

U.S. PATENT DOCUMENTS

D51,560 S	*	12/1917	Reizenstein	D9/522
2,102,643 A	*	12/1937	Pellegrini	220/62.11 X
D253,036 S	*	10/1979	Meyer et al.	D9/543
D318,803 S	*	8/1991	Bekius et al.	D9/424
D444,068 S	*	6/2001	Farris	D9/530
D482,286 S	*	11/2003	Samson et al.	D9/522
D484,402 S	*	12/2003	Crawford	D9/693
D485,184 S	*	1/2004	Hay et al.	D9/529 X
D520,877 S	*	5/2006	Toth et al.	D9/522
D523,344 S	*	6/2006	Toth et al.	D9/522
D527,638 S	*	9/2006	Stolle	D9/529 X

D529,387 S	*	10/2006	Toth et al.	D9/522
D531,905 S	*	11/2006	Day	D9/543 X
D535,564 S	*	1/2007	Toth et al.	D9/522
D536,981 S	*	2/2007	Toth et al.	D9/522
D537,724 S	*	3/2007	Toth et al.	D9/529 X
D540,162 S	*	4/2007	Chin et al.	D9/424 X
D540,678 S	*	4/2007	Brozell	D9/449
D557,134 S	*	12/2007	Wolpert et al.	D9/414
D561,031 S	*	2/2008	Lin	D9/575 X

* cited by examiner

Primary Examiner—Carol Rademaker

(74) *Attorney, Agent, or Firm*—Reising Ethington PC

(57) **CLAIM**

I claim the ornamental design for a container, as shown and described.

DESCRIPTION

FIG. 1 is a top, front, and left side perspective view showing the claimed design;

FIG. 2 is a front elevational view thereof;

FIG. 3 is a left side elevational view thereof, the right side elevational view being a mirror image;

FIG. 4 is a rear elevational view thereof;

FIG. 5 is a top plan view thereof; and,

FIG. 6 is a bottom plan view thereof.

The broken lines shown in the drawing views are included for the purpose of showing environmental structure that forms no part of the claimed design.

1 Claim, 1 Drawing Sheet

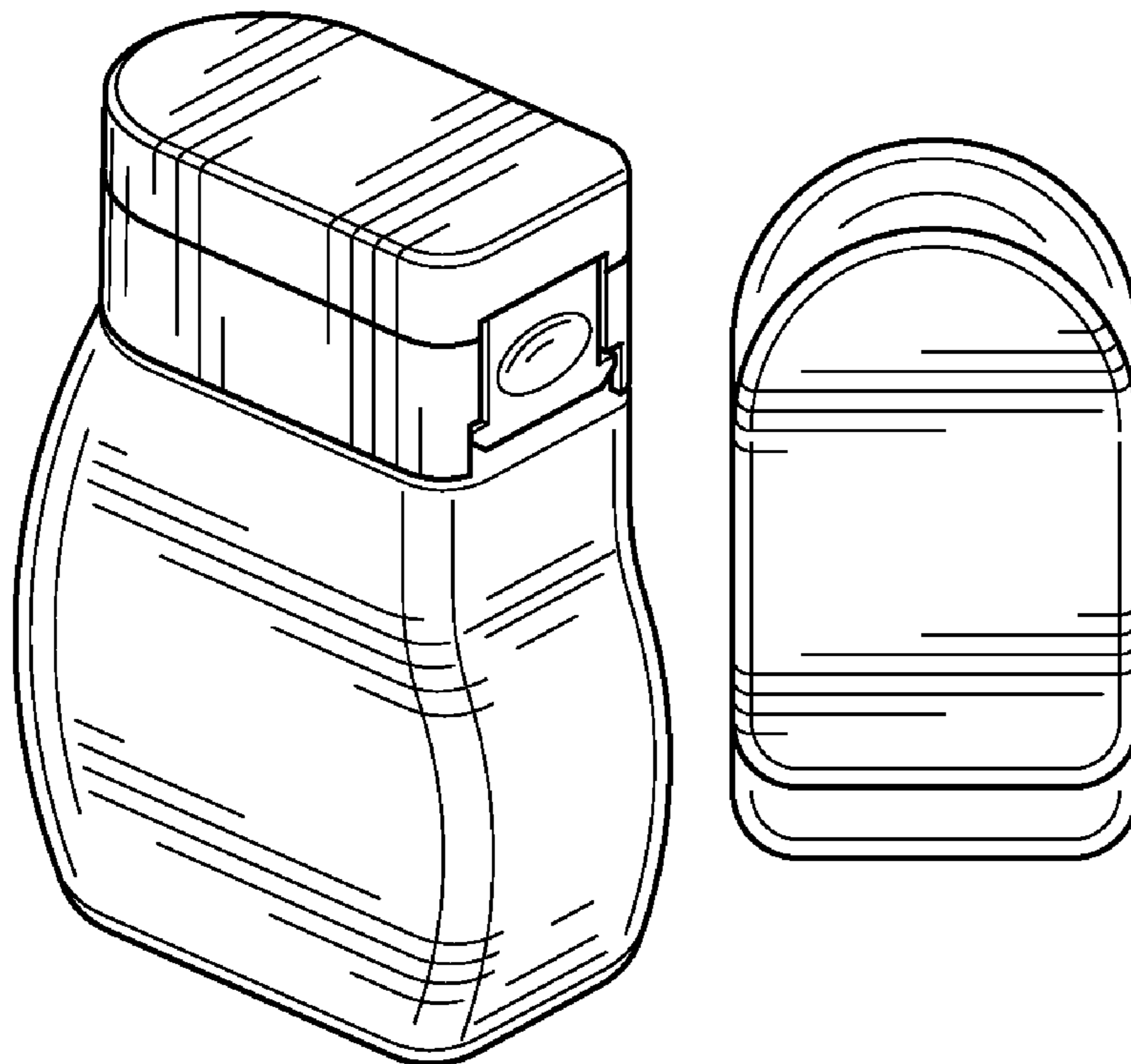

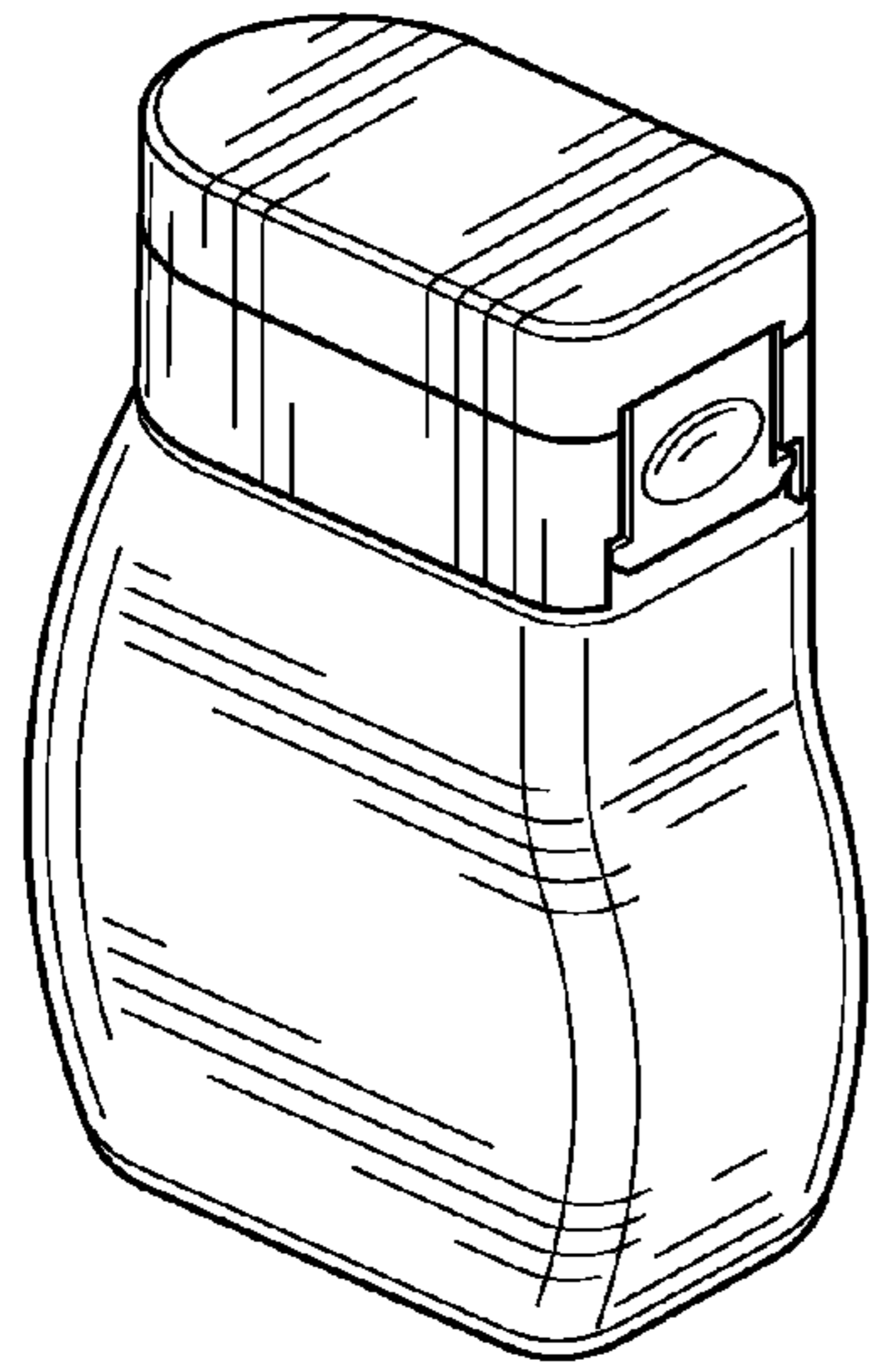

FIG. 1



FIG. 2

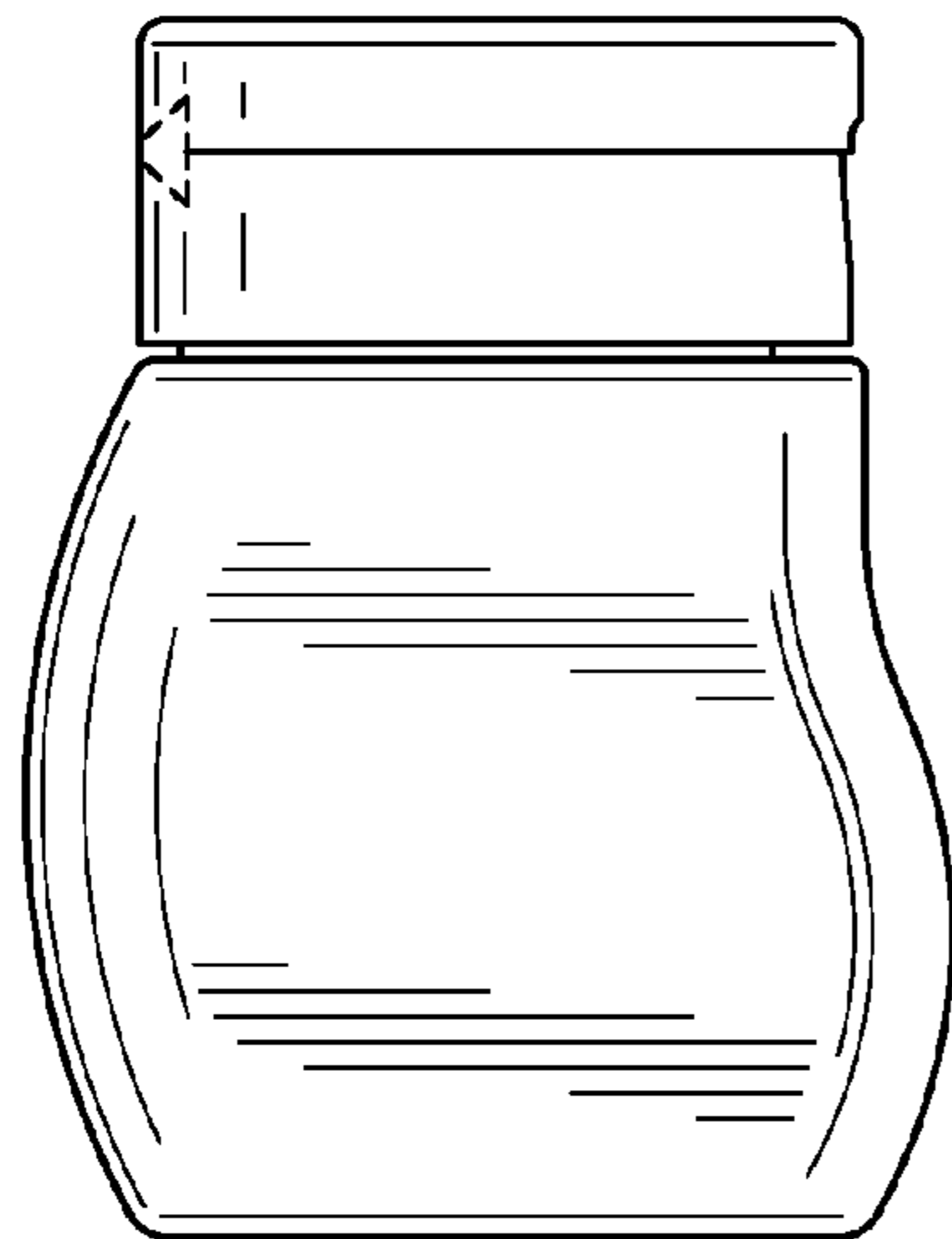

FIG. 3

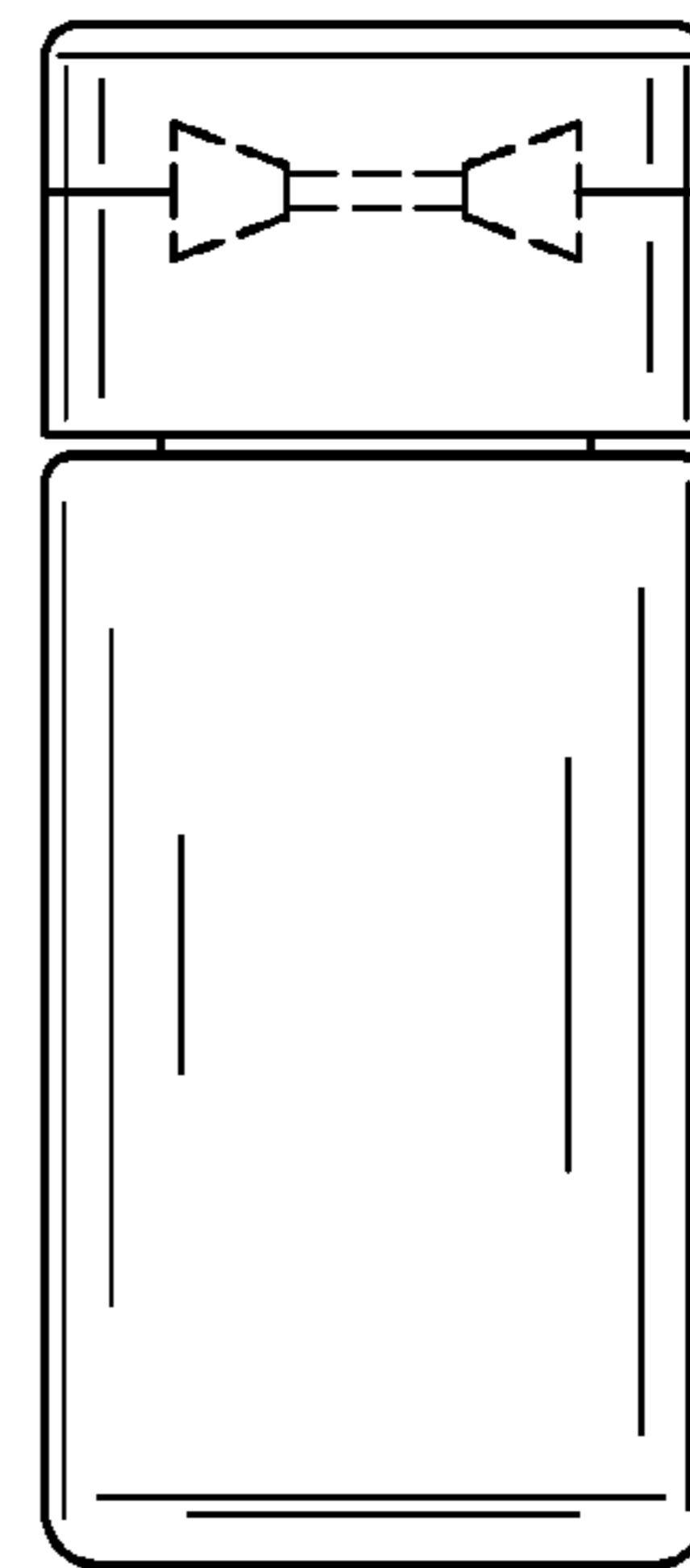

FIG. 4

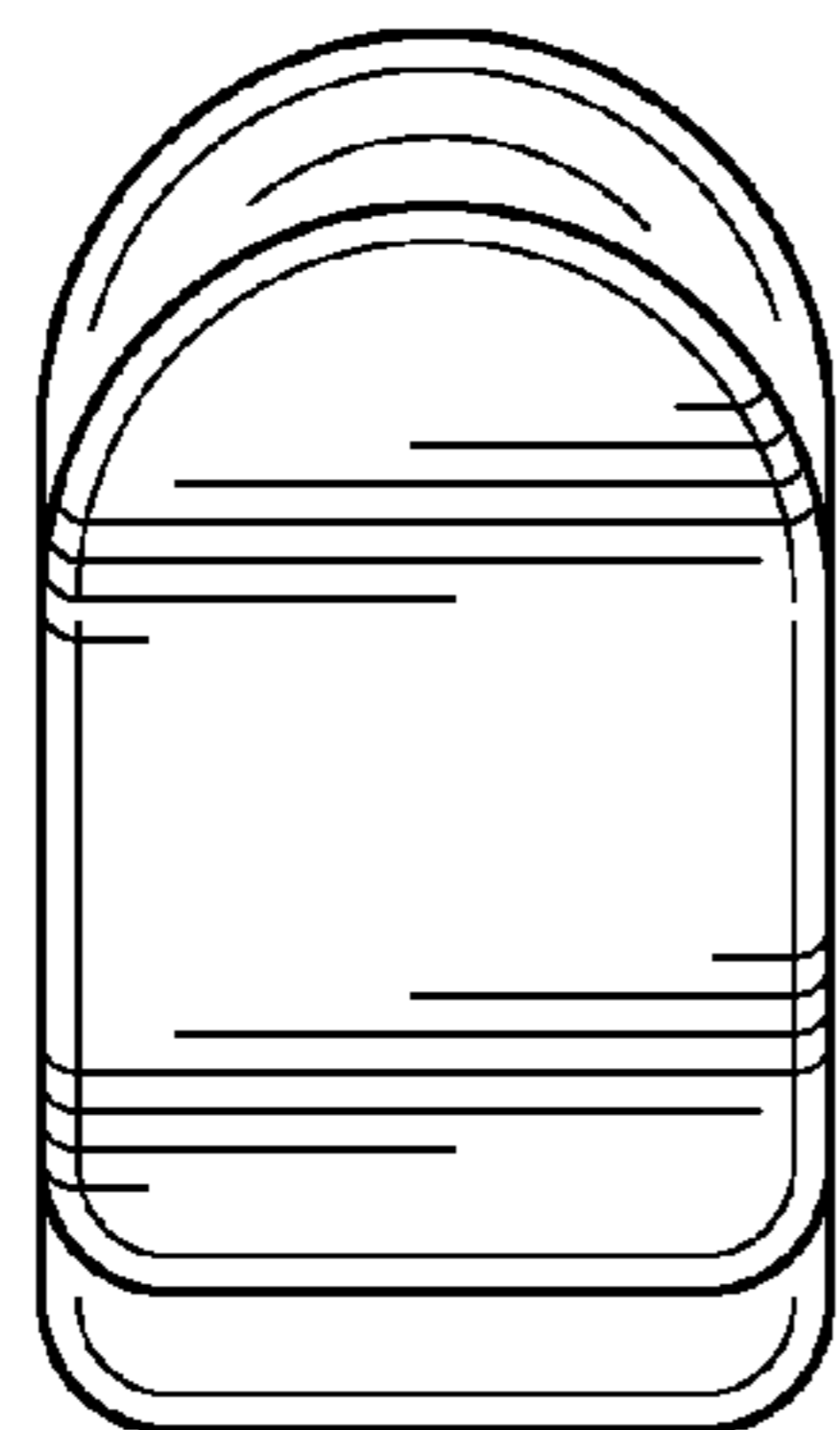

FIG. 5

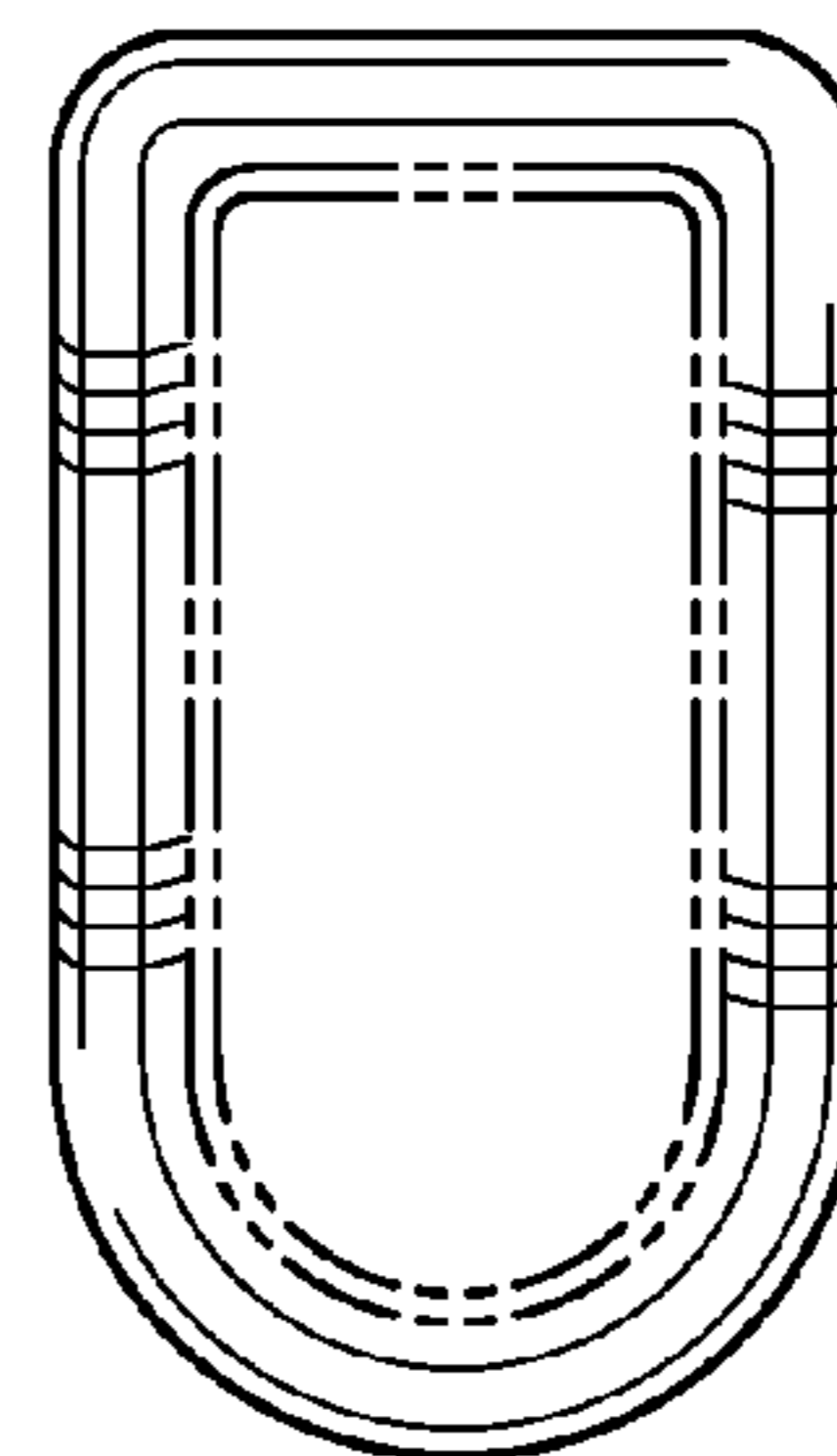

FIG. 6