



US00D619005S

(12) **United States Design Patent**
Lee

(10) **Patent No.:** **US D619,005 S**
(45) **Date of Patent:** **** Jul. 6, 2010**

(54) **TIE AND POCKET DECORATION HOLDER**

(57) **CLAIM**

(76) **Inventor:** **In Y. Lee**, 1270 Broadway, Suite 810,
New York, NY (US) 10001

The ornamental design for a tie and pocket decoration holder,
as shown and described.

(**) **Term:** **14 Years**

DESCRIPTION

(21) **Appl. No.:** **29/322,791**

FIG. 1 is a front elevational view of a first embodiment of a tie and pocket decoration holder showing my design therefor, the pocket decoration being shown as environment only and forming no part of the design;

(22) **Filed:** **Aug. 12, 2008**

FIG. 2 is a rear elevational view thereof, the pocket decoration being shown as environment only and forming no part of the design;

(51) **LOC (9) Cl.** **09-03**

(52) **U.S. Cl.** **D9/457; D9/434**

(58) **Field of Classification Search** D9/732,
D9/624, 500, 457, 456, 455, 446, 435, 434,
D9/433, 432, 418, 415, 414, 416, 420, 422,
D9/423; D20/42, 40, 28, 27, 22; 40/310;
283/62; 229/149; 206/728, 704, 703, 538,
206/534, 457, 278

FIG. 3 is a side elevational view thereof with the top opened for insertion of a pocket ornament, the opposite side being identical;

See application file for complete search history.

FIG. 4 is a top plan elevational view thereof with the top closed;

(56) **References Cited**

U.S. PATENT DOCUMENTS

- 1,398,364 A * 11/1921 Davidson 206/278
- D139,285 S * 10/1944 Gordon D9/457
- 6,328,341 B2 * 12/2001 Klure 283/62

FIG. 5 is a bottom plan view thereof;

FIG. 6 is a front elevational view of a second embodiment of the tie and pocket decoration holder showing my new design therefor, the pocket decoration being shown as environment only and forming no part of the design;

* cited by examiner

Primary Examiner—Susan Bennett Hattan
(74) *Attorney, Agent, or Firm*—Notaro, Michalos & Zaccaria P.C.

FIG. 7 is a rear elevational view thereof, the sides, top and bottom being identical to respective FIGS. 3, 4 and 5; and,

FIG. 8 is a front elevational view showing a tie and pocket decoration holder in accordance with my design with a tie and pocket decoration shown as environment only and forming no part of the design.

The broken lines in the drawings depict environmental subject matter only and form no part of the claimed design.

1 Claim, 4 Drawing Sheets

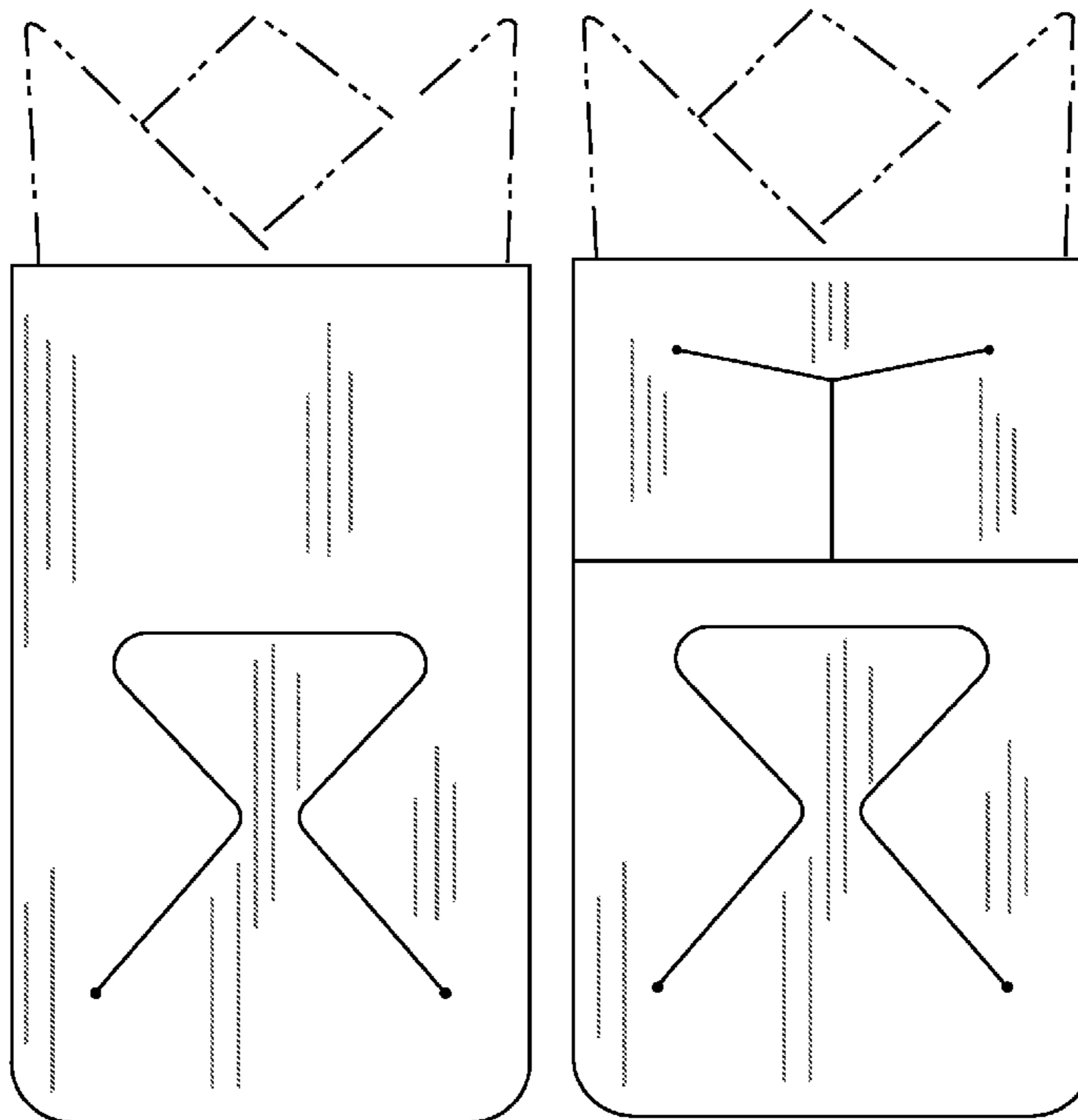

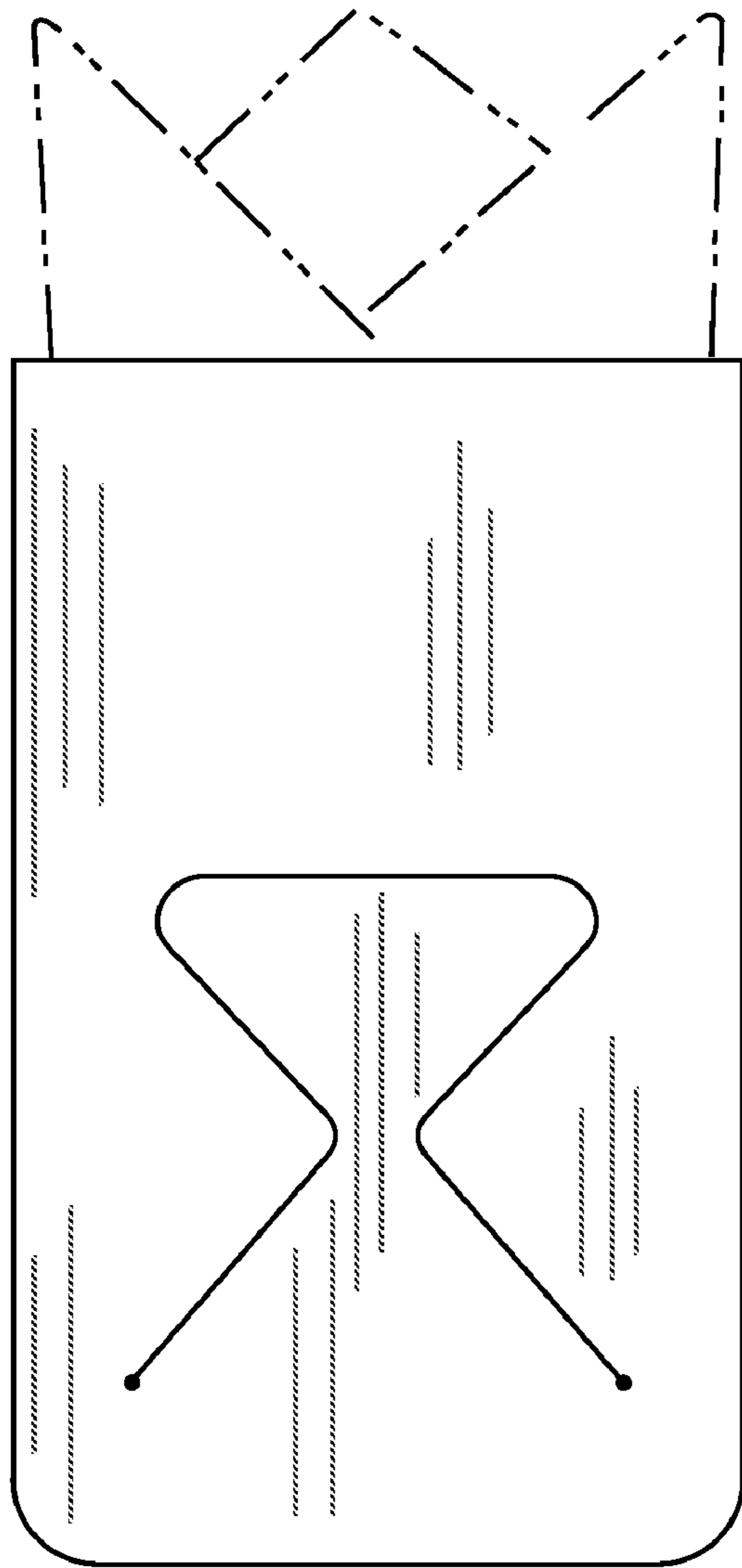

FIG. 1

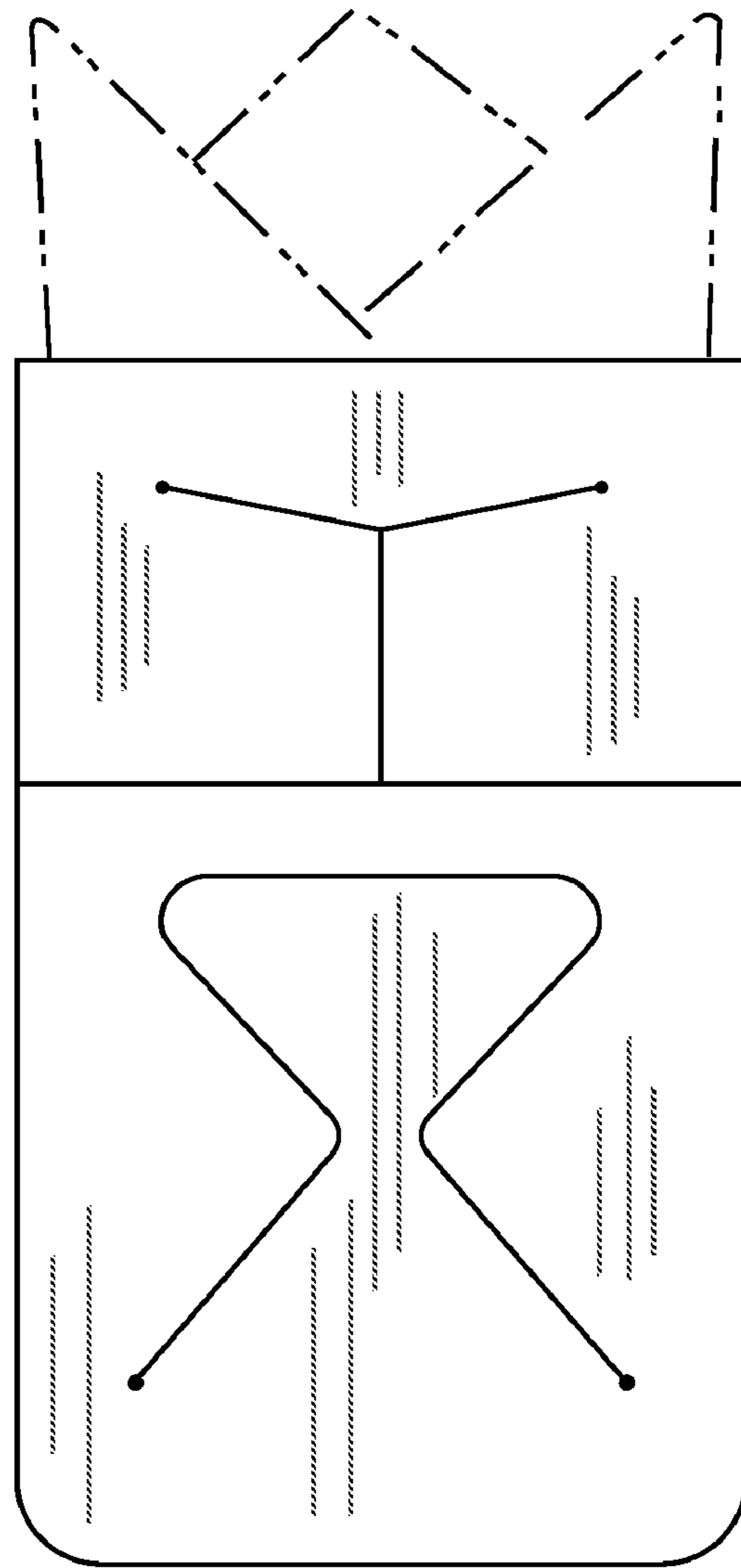

FIG. 2

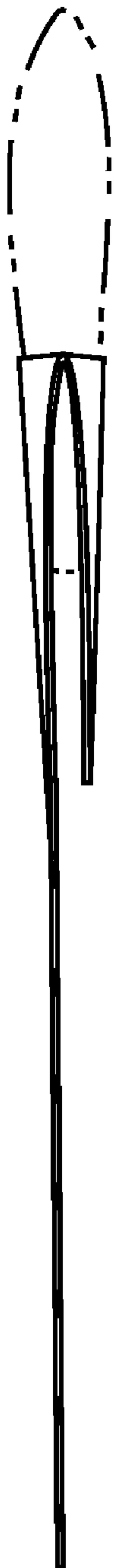

FIG. 3



FIG. 4



FIG. 5

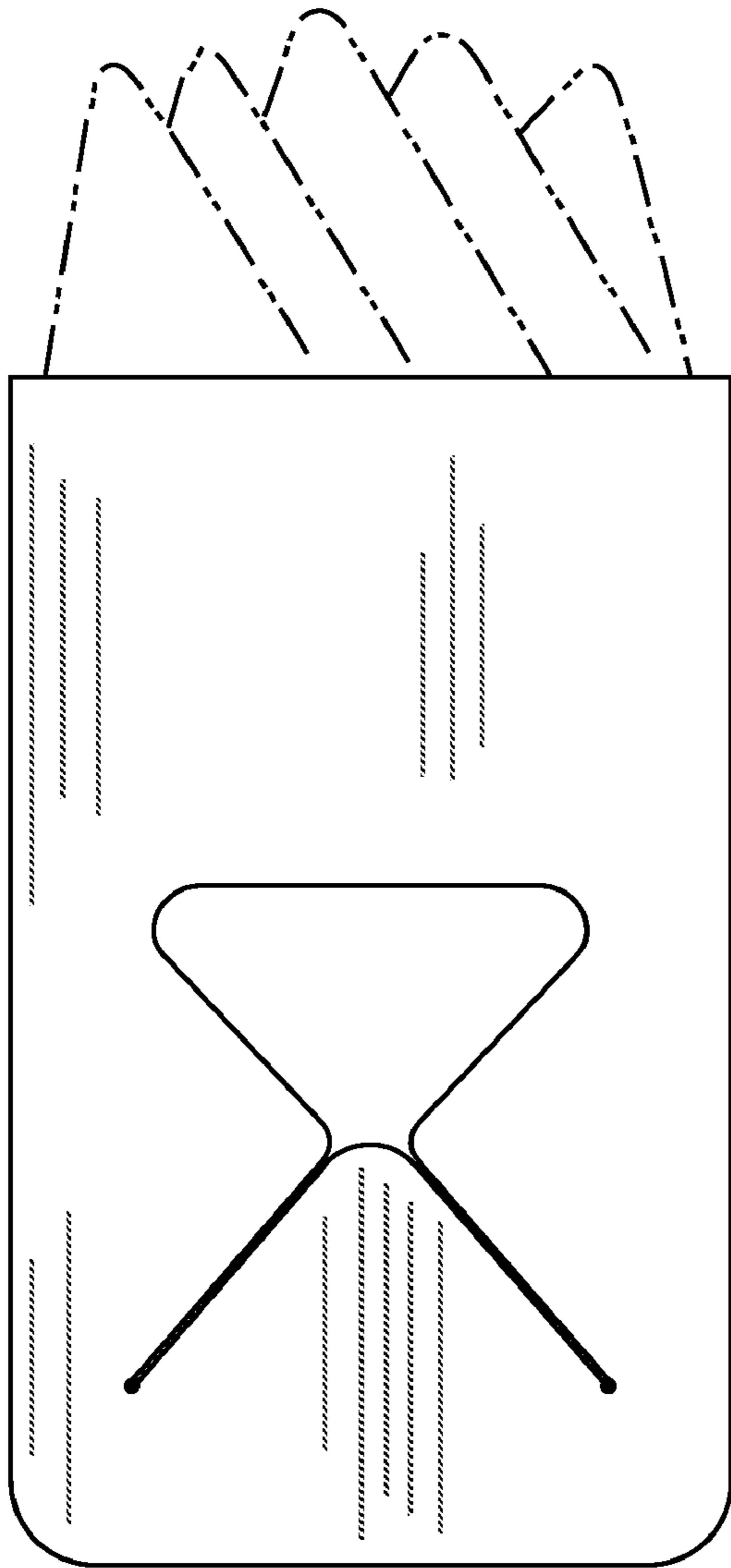

FIG. 6

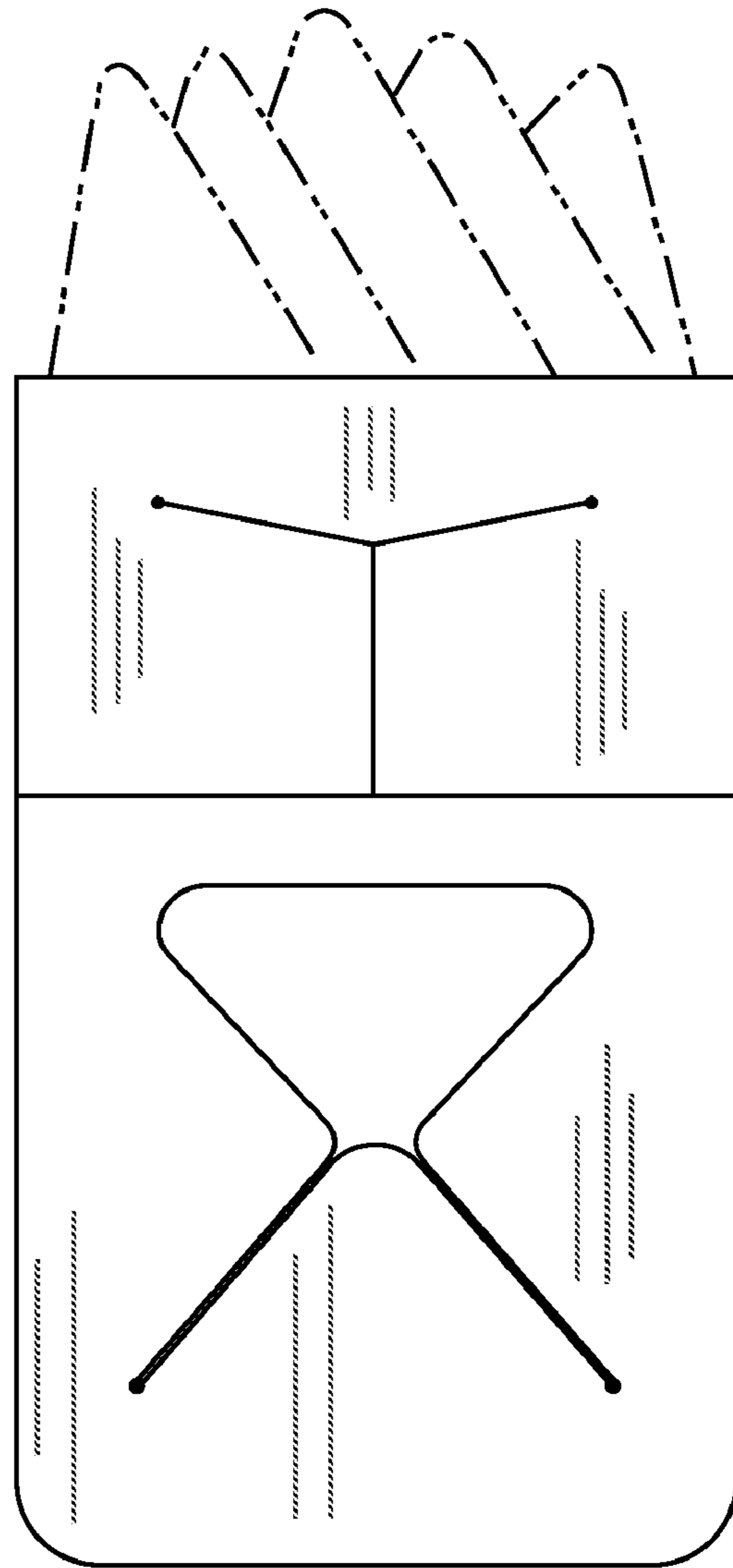

FIG. 7

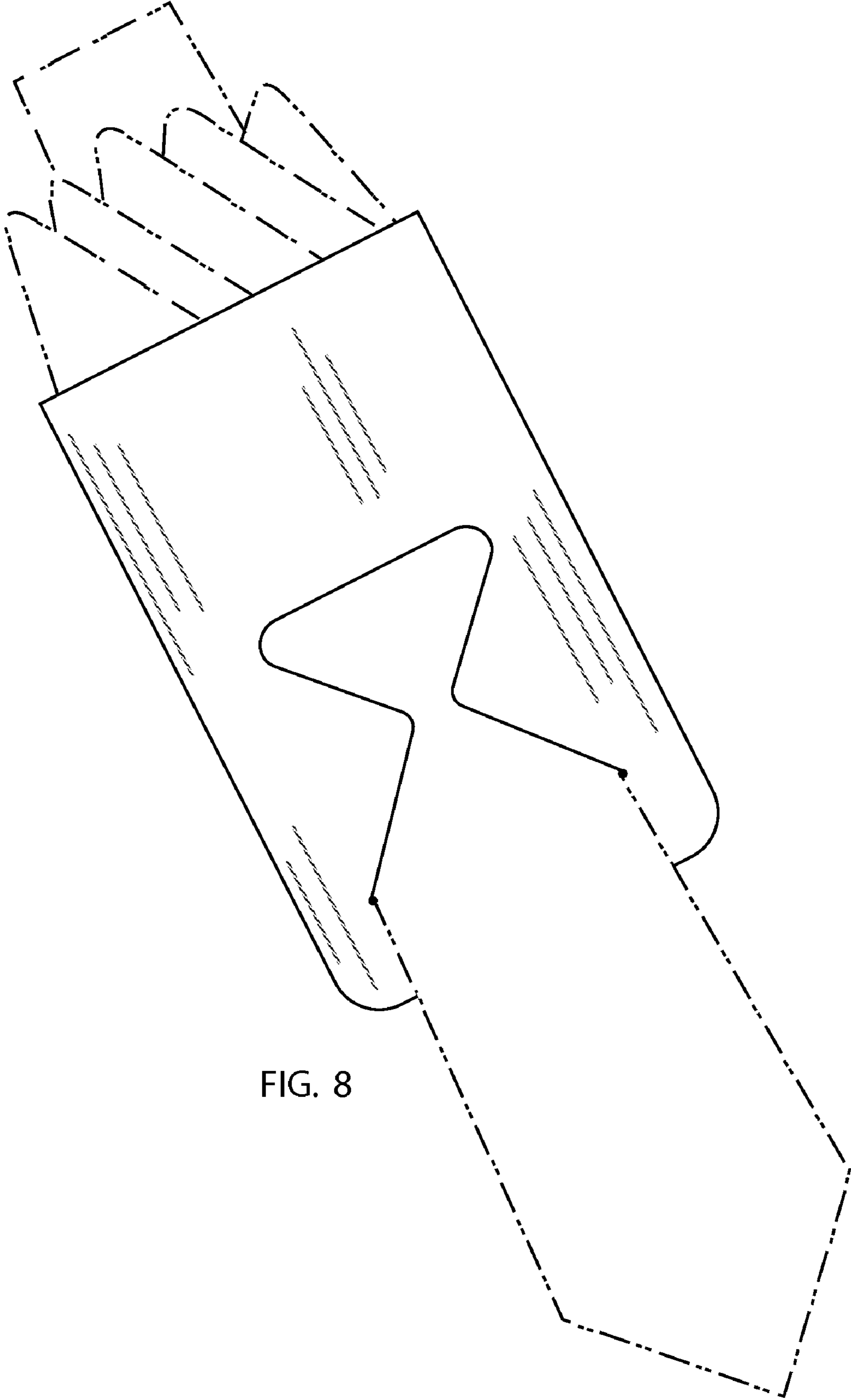

FIG. 8