



US00D618998S

(12) **United States Design Patent**  
**Pendergrass et al.**

(10) **Patent No.:** **US D618,998 S**  
(45) **Date of Patent:** **\*\* Jul. 6, 2010**

- (54) **STAND-UP FOOD TRAY**
- (75) Inventors: **William B. Pendergrass**, Asheville, NC (US); **Russell L. Bauer**, Waynesville, NC (US)
- (73) Assignee: **Associated Packaging Enterprises, Inc.**, Chadds Ford, PA (US)
- (\*\*) Term: **14 Years**
- (21) Appl. No.: **29/338,586**
- (22) Filed: **Jun. 15, 2009**

- D471,442 S 3/2003 Lee
- D482,277 S 11/2003 Castellanos et al.
- D502,869 S \* 3/2005 Clarke ..... D9/425
- D528,908 S 9/2006 Faktorovich et al.
- 2006/0237454 A1 10/2006 Clarke

\* cited by examiner

*Primary Examiner*—Prabhakar Deshmukh  
*Assistant Examiner*—Derrick Holland  
(74) *Attorney, Agent, or Firm*—Banner & Witcoff, Ltd.

**Related U.S. Application Data**

- (62) Division of application No. 29/306,302, filed on Apr. 7, 2008, now Pat. No. Des. 602,352.

- (51) **LOC (9) Cl.** ..... **09-03**
- (52) **U.S. Cl.** ..... **D9/424**
- (58) **Field of Classification Search** ..... D9/424, D9/414, 415, 416, 419, 420, 423, 425, 426, D9/429, 432, 566; D3/201, 294, 304; D7/602, D7/629; 206/449, 499, 505, 822; 220/315, 220/324, 659, 675; 229/108, 406, 407, 906  
See application file for complete search history.

(56) **References Cited**

**U.S. PATENT DOCUMENTS**

- D151,679 S 11/1948 Braun et al.
- 3,029,937 A 4/1962 Vogt
- D198,475 S 6/1964 Mojonnier
- 3,344,974 A 10/1967 Bostrom
- 3,410,698 A 11/1968 Sosin
- 3,937,389 A 2/1976 Wind
- D253,456 S 11/1979 Payne
- D276,381 S 11/1984 Nagle et al.
- D309,715 S 8/1990 Kuerti
- D312,781 S \* 12/1990 Rigby ..... D9/420
- D318,426 S \* 7/1991 Vroonen ..... D9/426
- D322,757 S \* 12/1991 Payne ..... D9/425
- D323,114 S \* 1/1992 Sheehan ..... D9/420
- 5,083,700 A 1/1992 Mello et al.
- D334,141 S 3/1993 Gottofredi
- D343,768 S \* 2/1994 Cautereels et al. .... D7/629
- D382,956 S 8/1997 Collins
- D409,911 S 5/1999 Guillin

(57) **CLAIM**

The ornamental design for a stand-up food tray, as shown and described.

**DESCRIPTION**

FIG. 1 is a perspective view of a stand-up food tray showing our new design;

FIG. 2 is a front elevation view thereof;

FIG. 3 is a rear elevation view thereof;

FIG. 4 is a left side elevation view thereof;

FIG. 5 is a right side elevation view thereof;

FIG. 6 is a top plan view thereof;

FIG. 7 is a bottom plan view thereof;

FIG. 8 is a perspective view thereof, shown in a closed condition;

FIG. 9 is a front elevation view thereof;

FIG. 10 is a rear elevation view thereof;

FIG. 11 is a left side elevation view thereof;

FIG. 12 is a right side elevation view thereof;

FIG. 13 is a left side elevation view thereof, rotated 90 degrees from FIG. 12;

FIG. 14 is a top plan view thereof; and,

FIG. 15 is a bottom plan view thereof.

The broken lines are shown for illustrative purposes only and form no part of the claimed design.

**1 Claim, 11 Drawing Sheets**

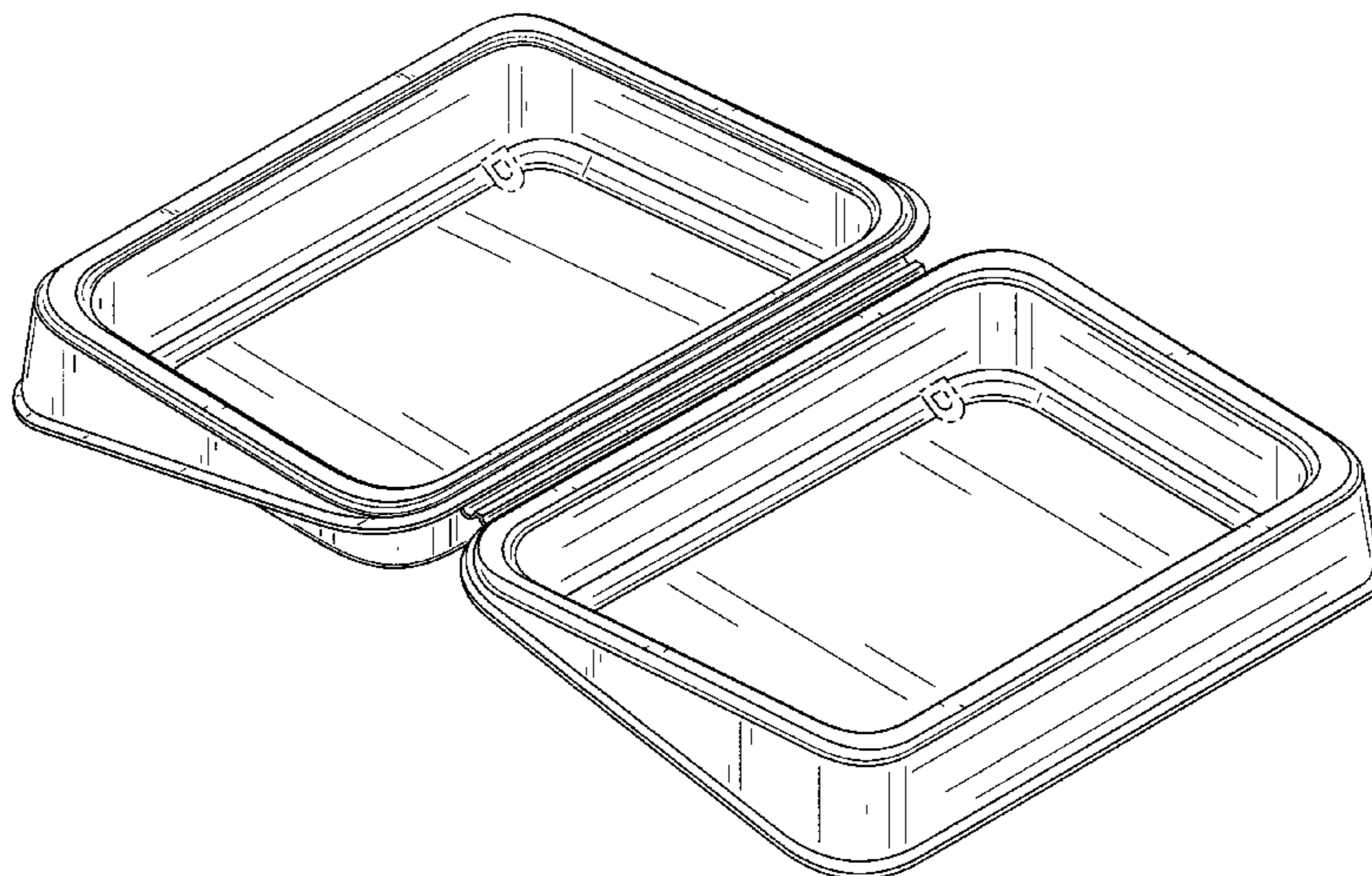

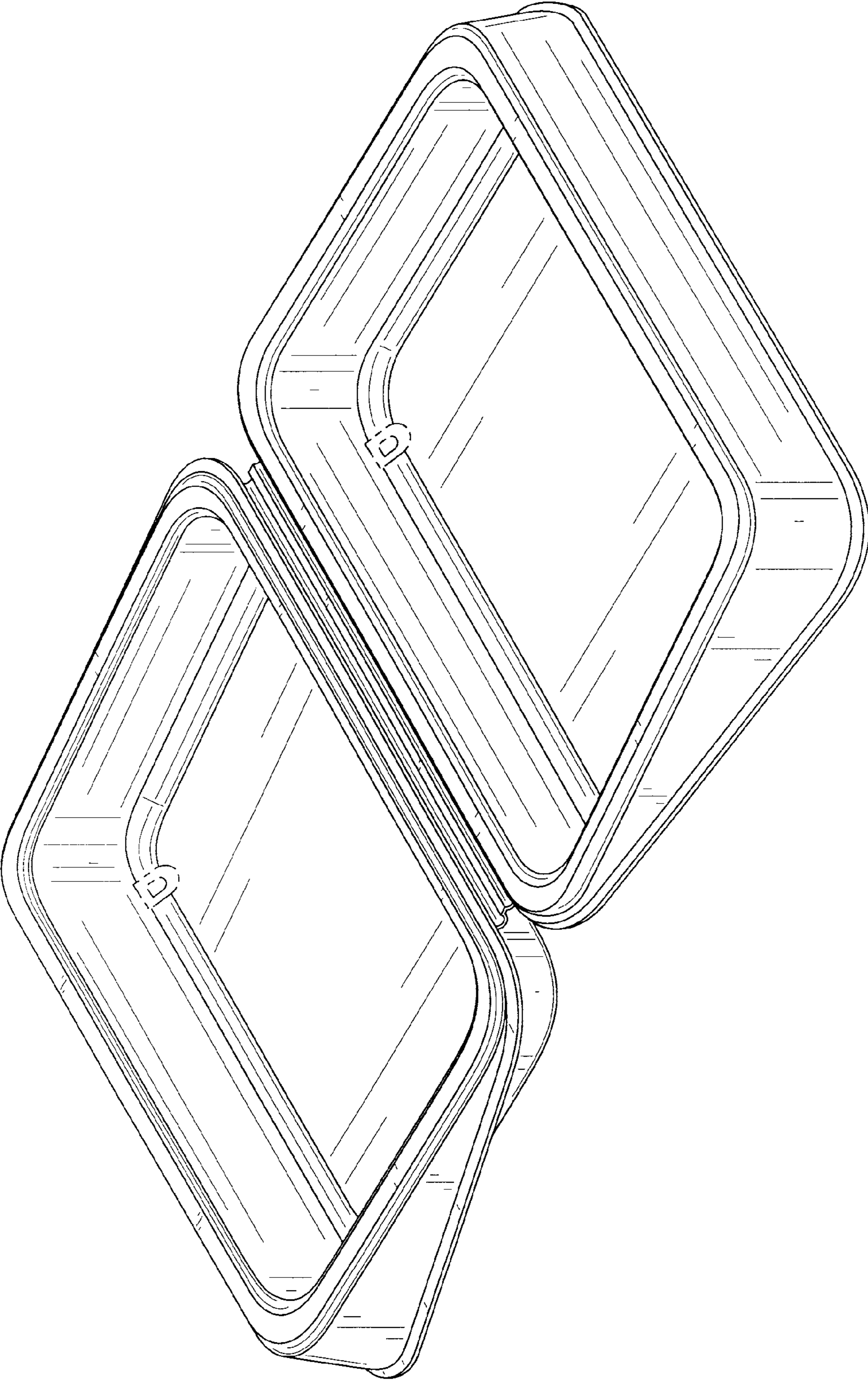

FIG. 1

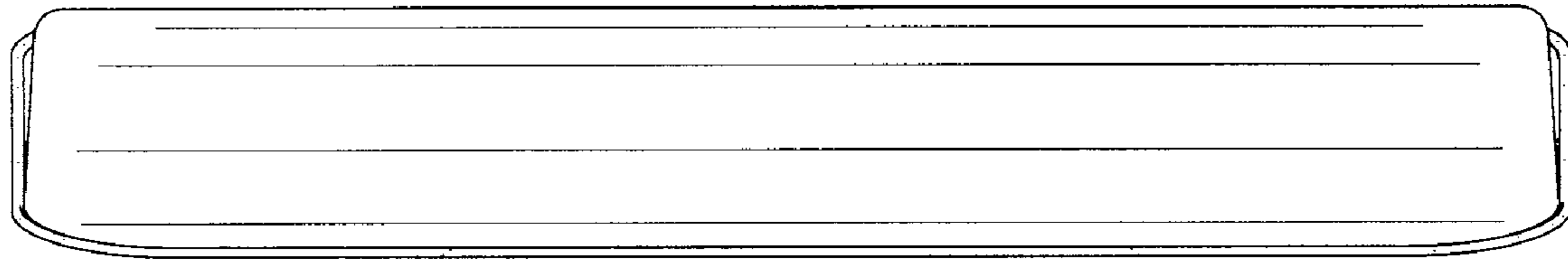

FIG. 2

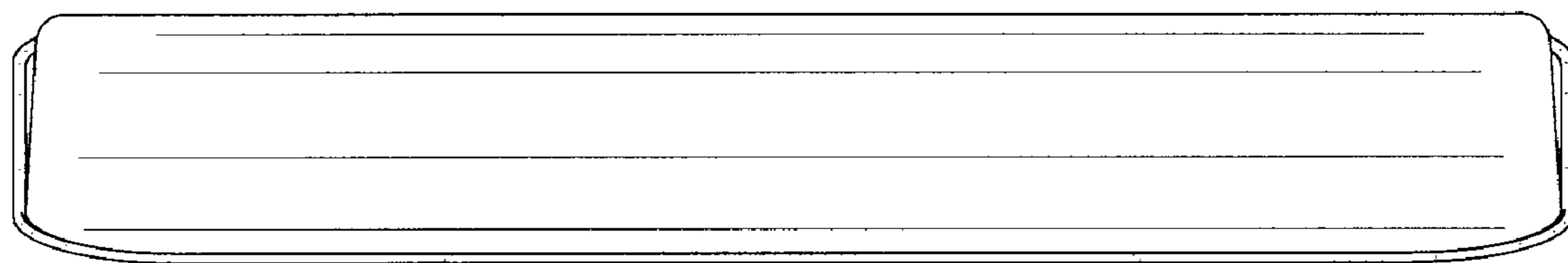

FIG. 3

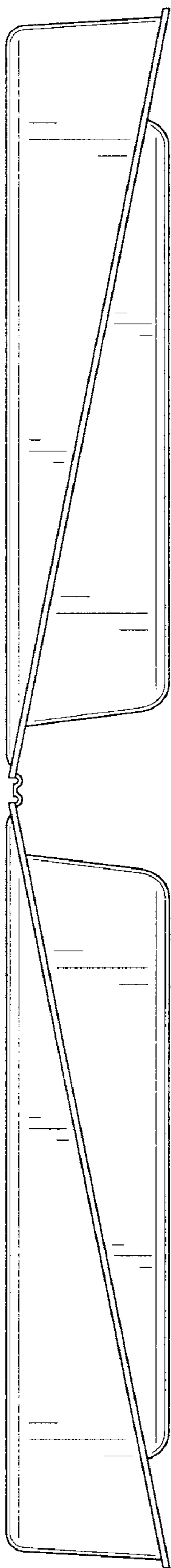

FIG. 4

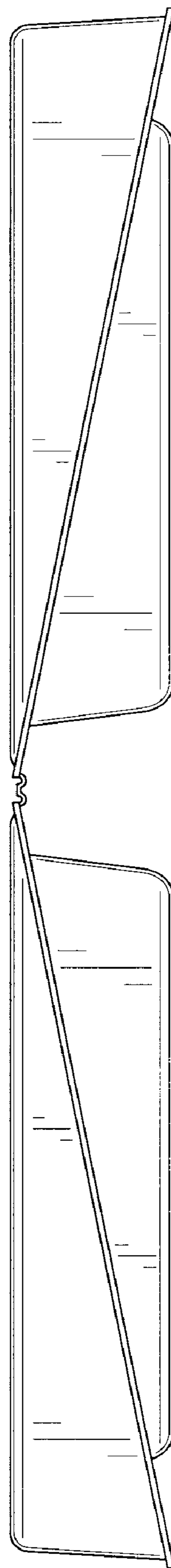

FIG. 5

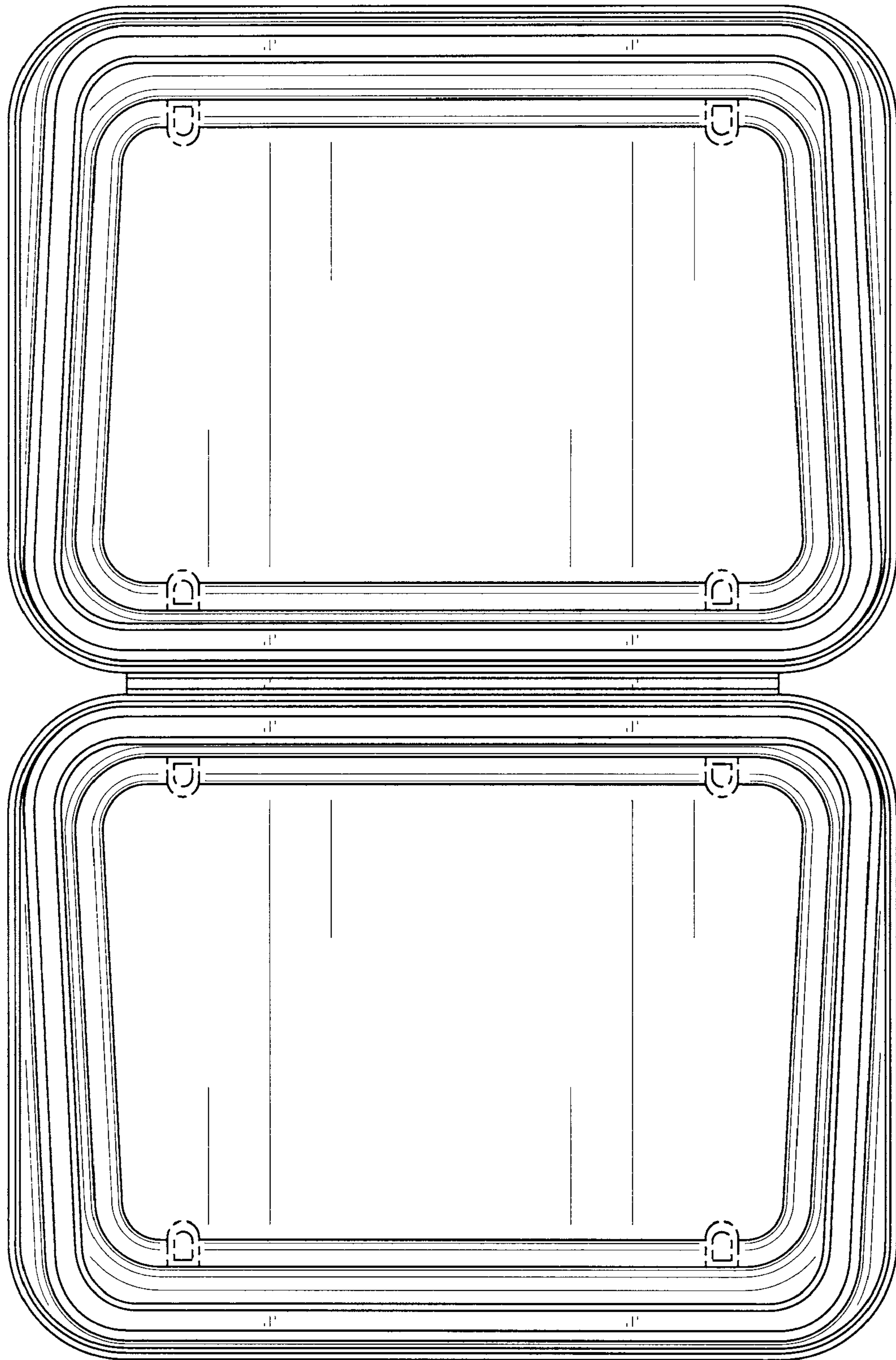

FIG. 6

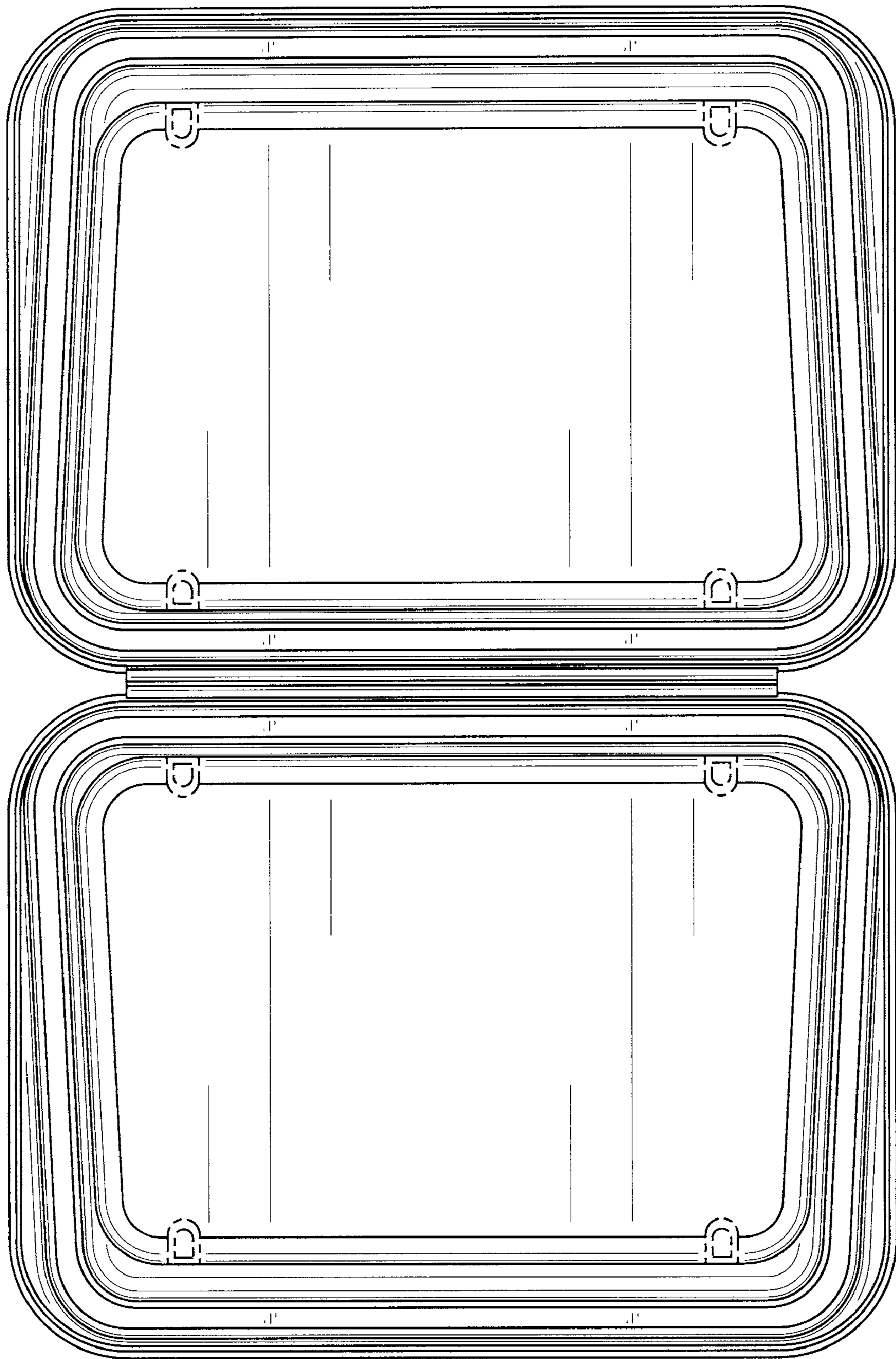

FIG. 7

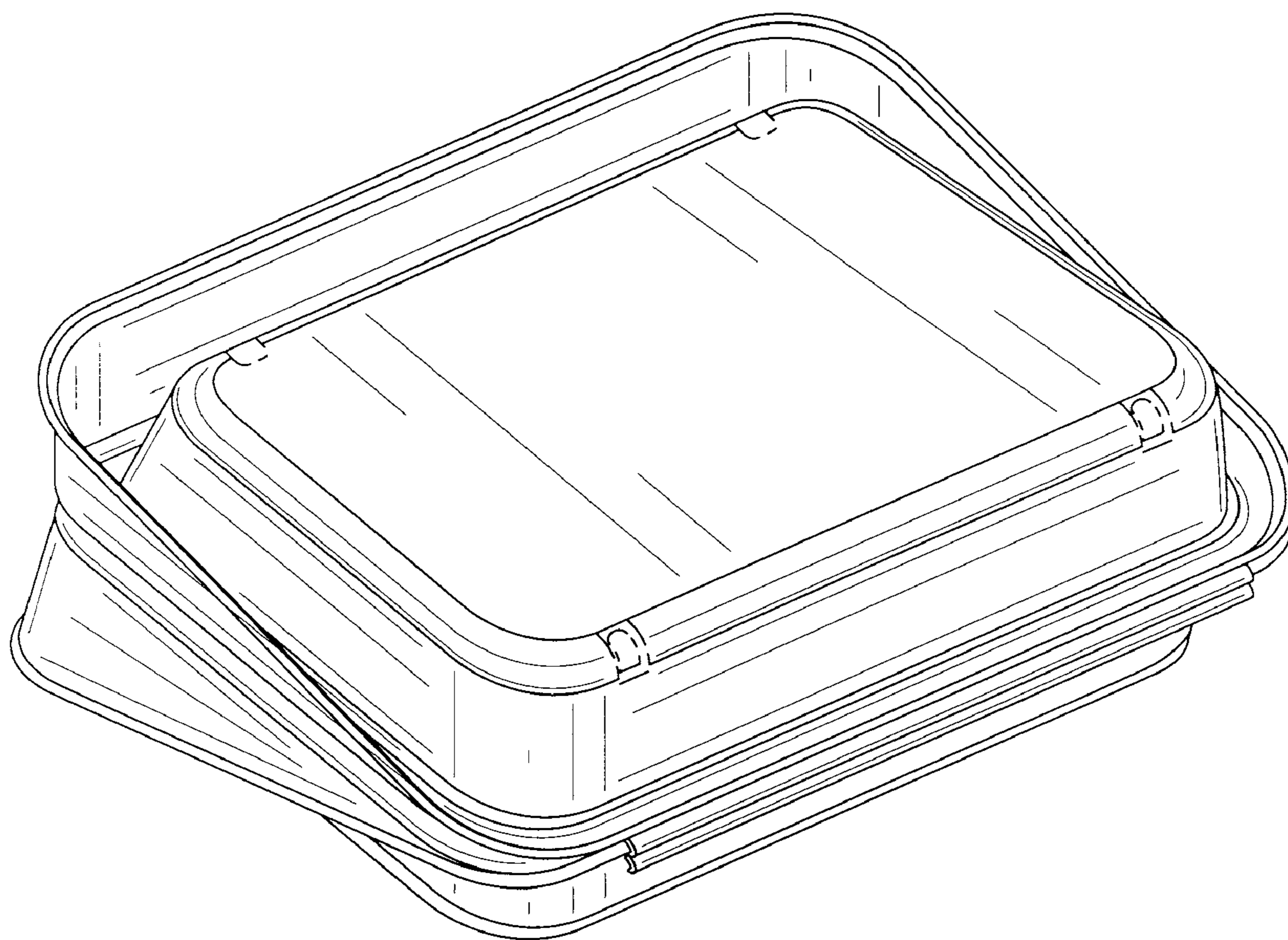

FIG. 8

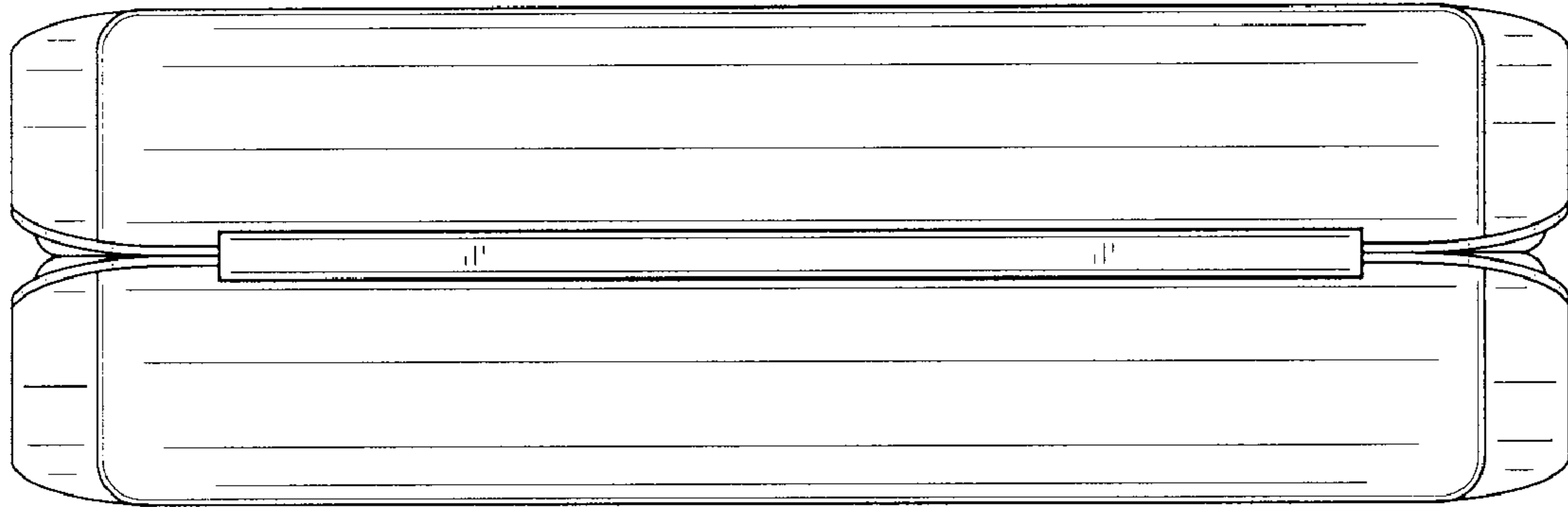

FIG. 9

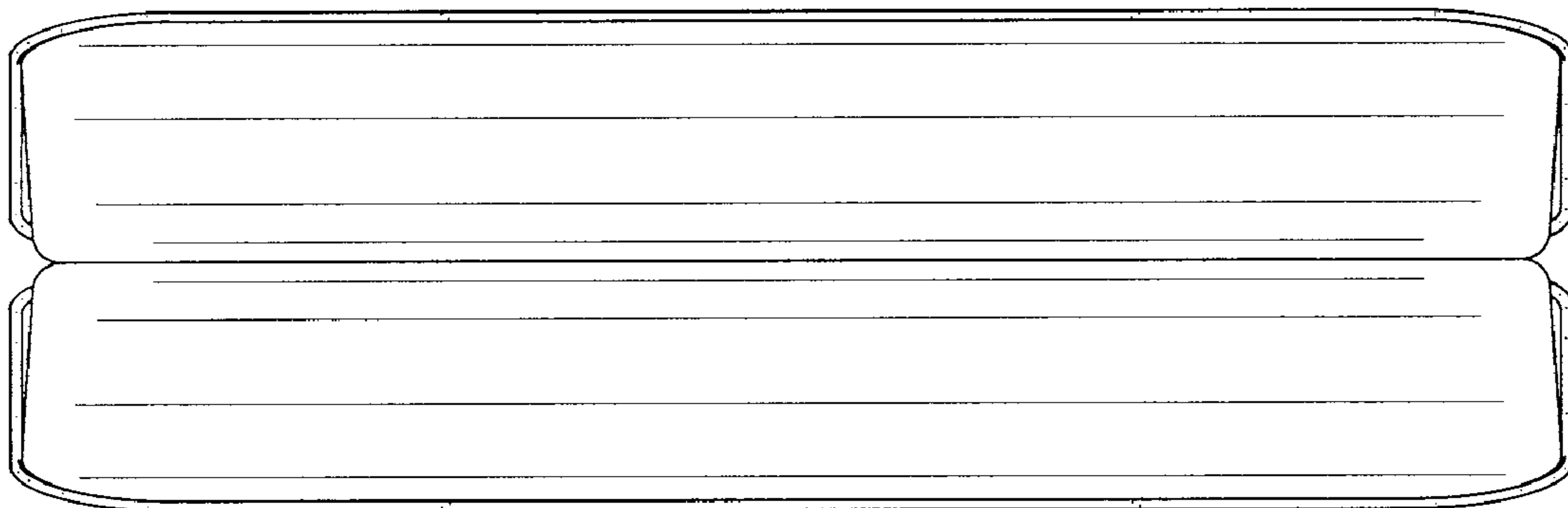

FIG. 10



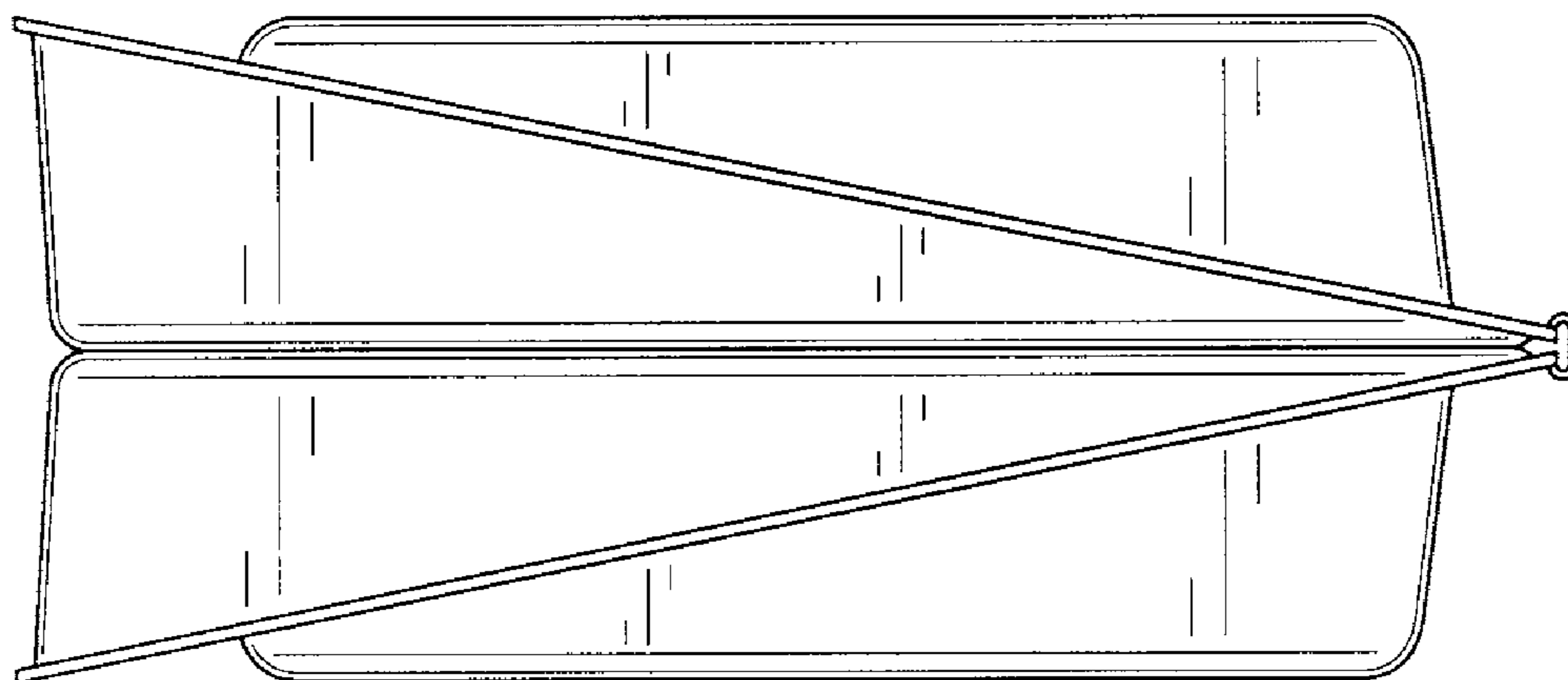

FIG. 11

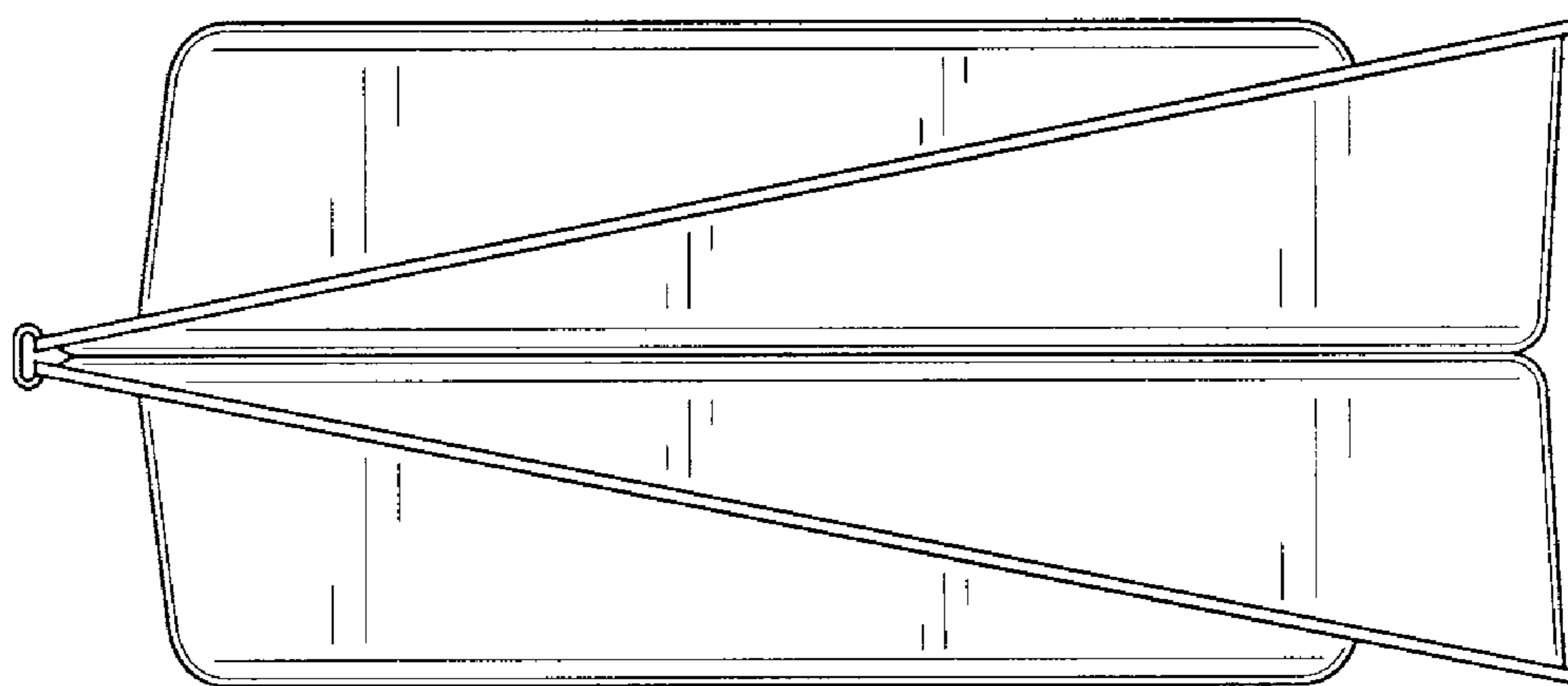

FIG. 12

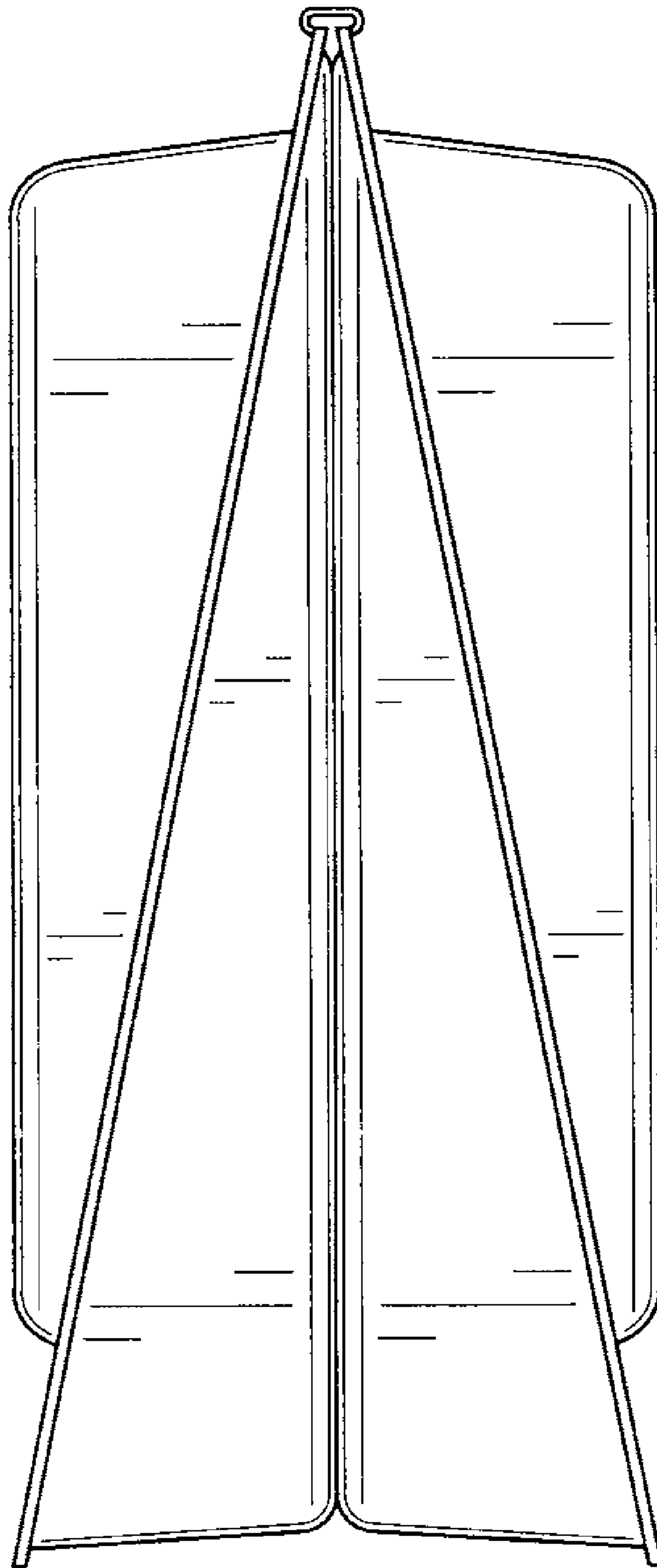

FIG. 13

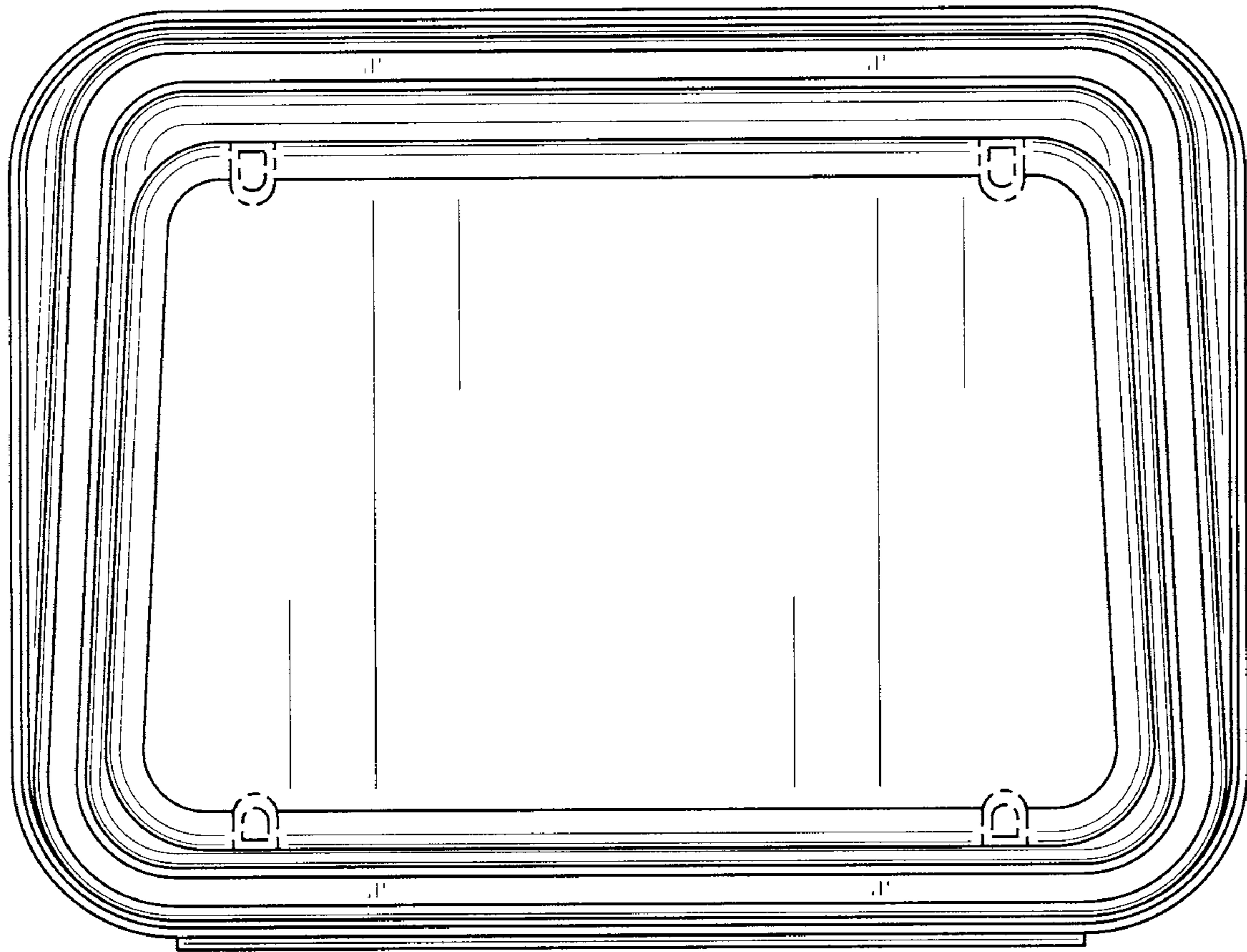

FIG. 14

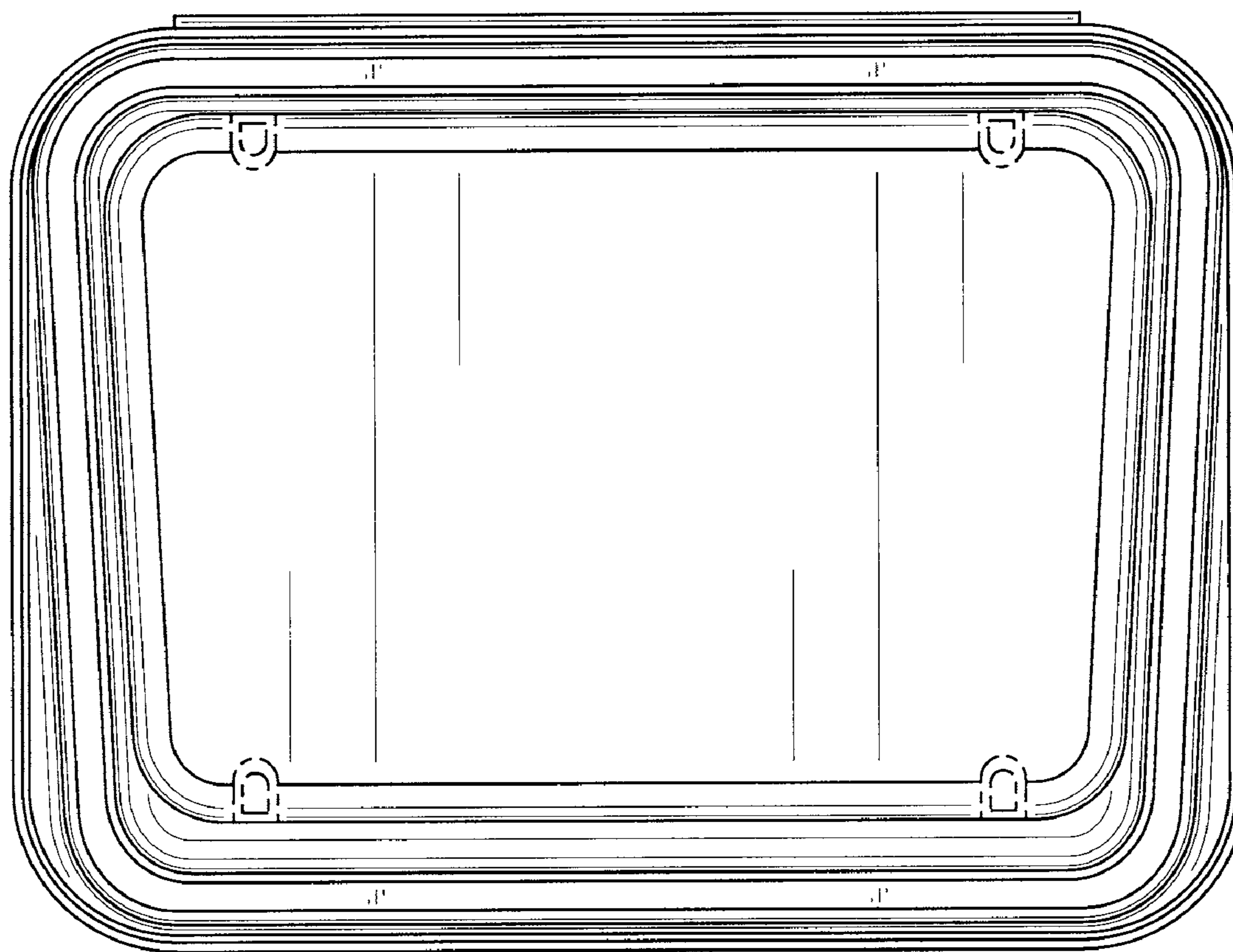

FIG. 15

UNITED STATES PATENT AND TRADEMARK OFFICE  
**CERTIFICATE OF CORRECTION**

PATENT NO. : Des. 618,998 S  
APPLICATION NO. : 29/338586  
DATED : July 6, 2010  
INVENTOR(S) : William B. Pendergrass et al.

Page 1 of 1

It is certified that error appears in the above-identified patent and that said Letters Patent is hereby corrected as shown below:

In Inventors (75):  
Please delete "Bauer" and insert -- Baur --.

Signed and Sealed this

Nineteenth Day of October, 2010

A handwritten signature in black ink that reads "David J. Kappos". The signature is written in a cursive style with a large, prominent 'D' and 'K'.

David J. Kappos  
*Director of the United States Patent and Trademark Office*