



US00D618932S

(12) **United States Design Patent**
Linder

(10) **Patent No.:** **US D618,932 S**

(45) **Date of Patent:** **** Jul. 6, 2010**

(54) **MERCHANDISE DISPLAY CABINET**

(76) **Inventor:** **Nathan Linder**, 100 N. Citrus St., #610,
West Covina, CA (US) 91791

(**) **Term:** **14 Years**

(21) **Appl. No.:** **29/342,310**

(22) **Filed:** **Aug. 21, 2009**

(51) **LOC (9) Cl.** **06-04**

(52) **U.S. Cl.** **D6/479**

(58) **Field of Classification Search** D6/449,
D6/474, 479, 478; 108/92; 211/188
See application file for complete search history.

(56) **References Cited**

U.S. PATENT DOCUMENTS

D286,114 S	*	10/1986	Bosland	D6/477
D325,680 S	*	4/1992	Kiiski	D6/479
D402,140 S	*	12/1998	Bustos	D6/473
D402,829 S	*	12/1998	Jay	D6/479
D417,977 S	*	12/1999	Veto	D6/465
D430,432 S	*	9/2000	Mason	D6/465
D519,133 S	*	4/2006	Chang	D15/81
D584,413 S	*	1/2009	Lambalot	D24/185

* cited by examiner

Primary Examiner—Elizabeth A Albert

Assistant Examiner—Kelley A Donnelly

(74) *Attorney, Agent, or Firm*—Stetina Brunda Garred & Brucker

(57) **CLAIM**

I claim the ornamental design for a merchandise display cabinet, as shown and described.

DESCRIPTION

FIG. 1 is a perspective view of the front of a merchandise display cabinet showing my new design;

FIG. 2 is a perspective view showing the back of the cabinet;

FIG. 3 is a top view thereof;

FIG. 4 is a frontal view thereof, the rear view being a mirror image thereof;

FIG. 5 is a left side view thereof;

FIG. 6 is a bottom view thereof; and,

FIG. 7 is a right side view thereof.

The broken lines showing other cabinets are included for the purpose of illustrating environment and form no part of the claimed design.

1 Claim, 2 Drawing Sheets

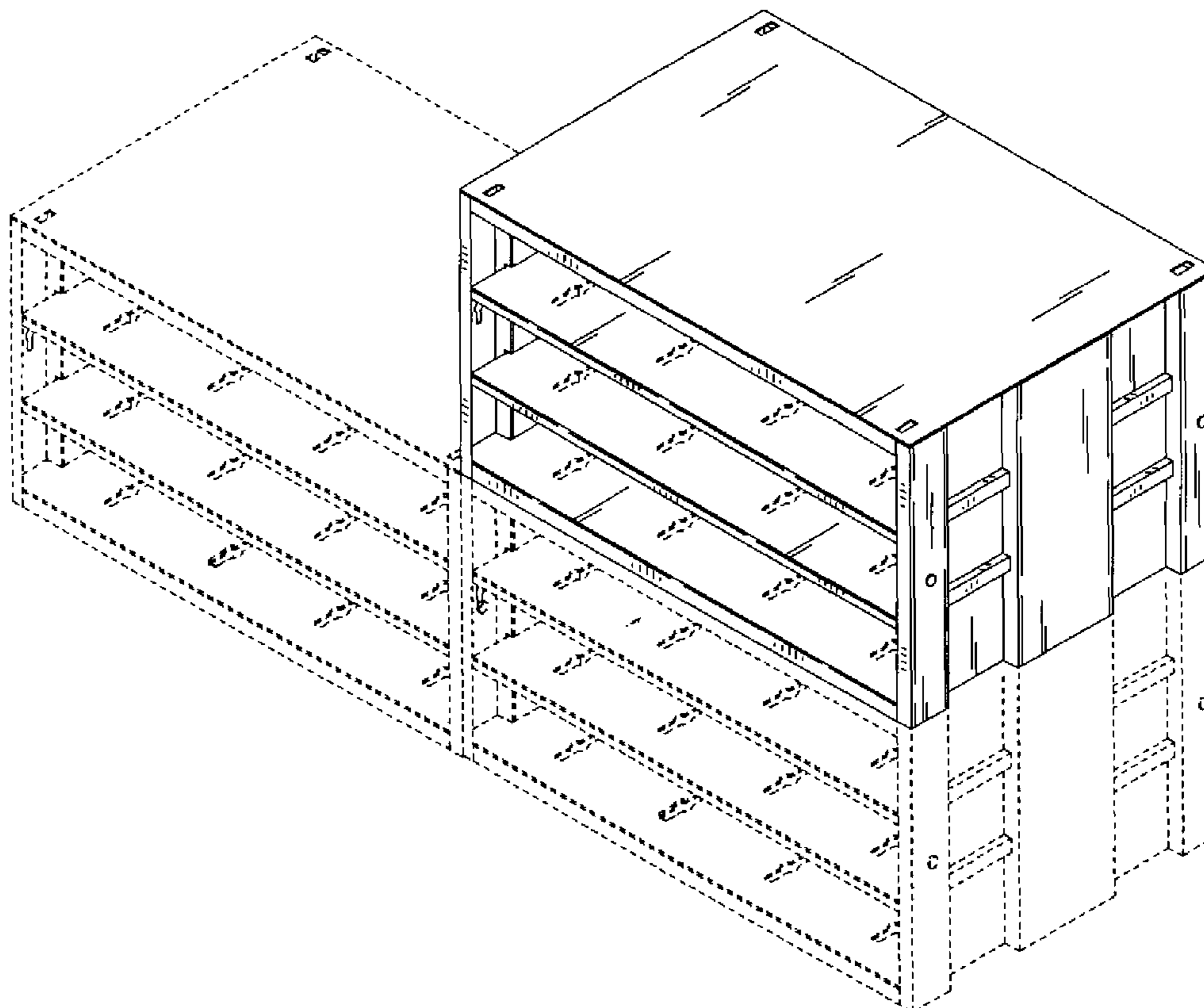

Fig. 1

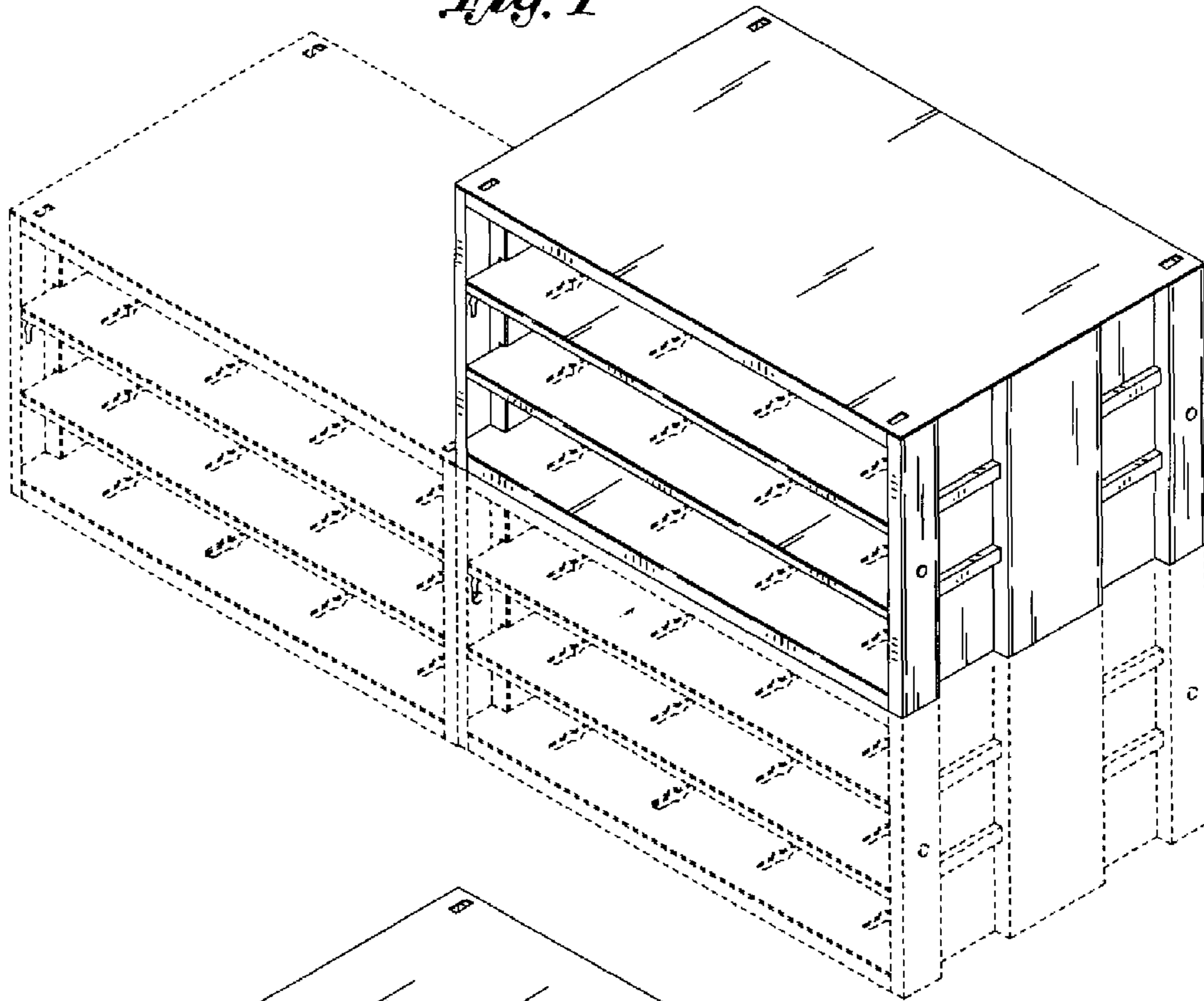
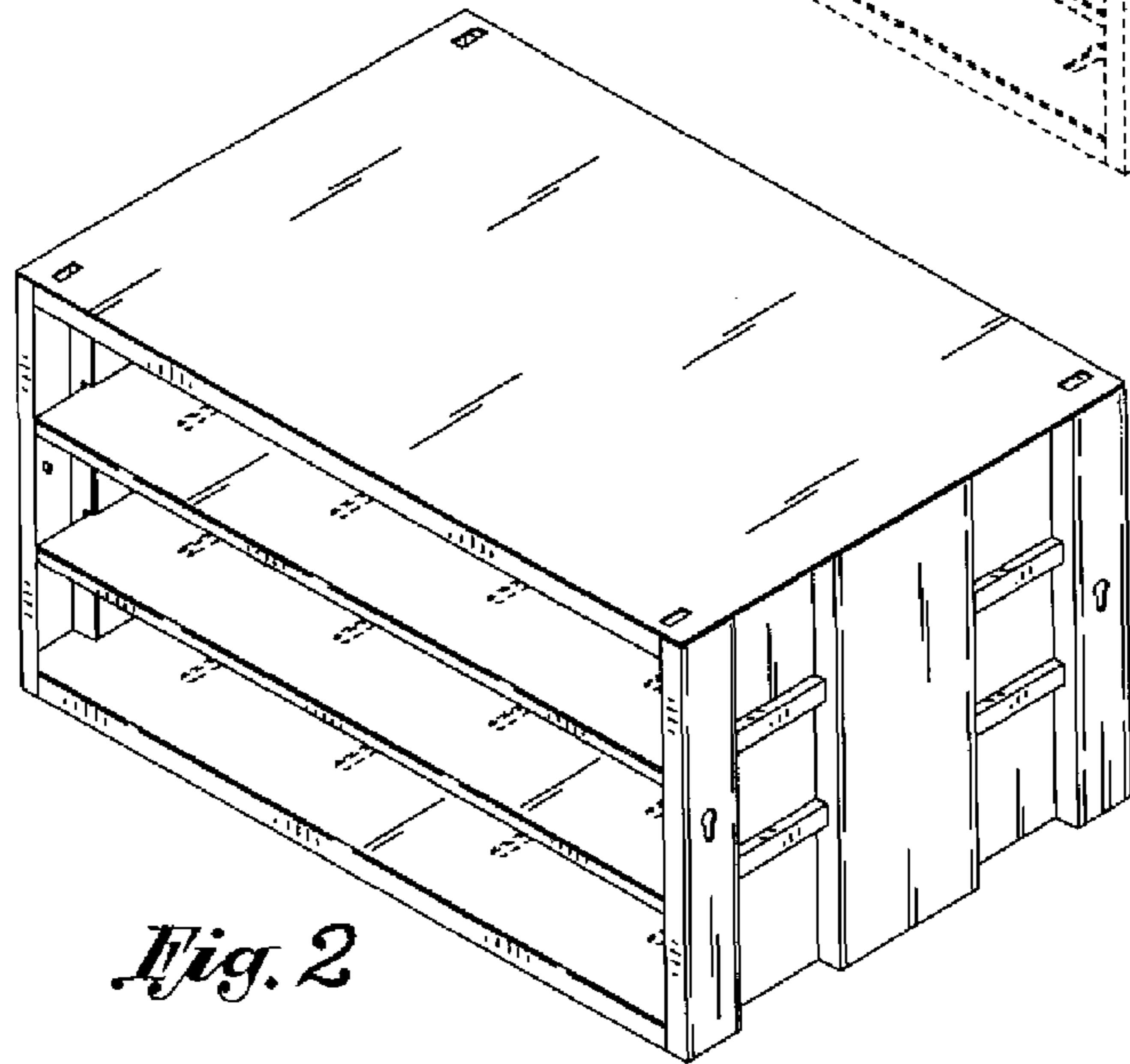

Fig. 2



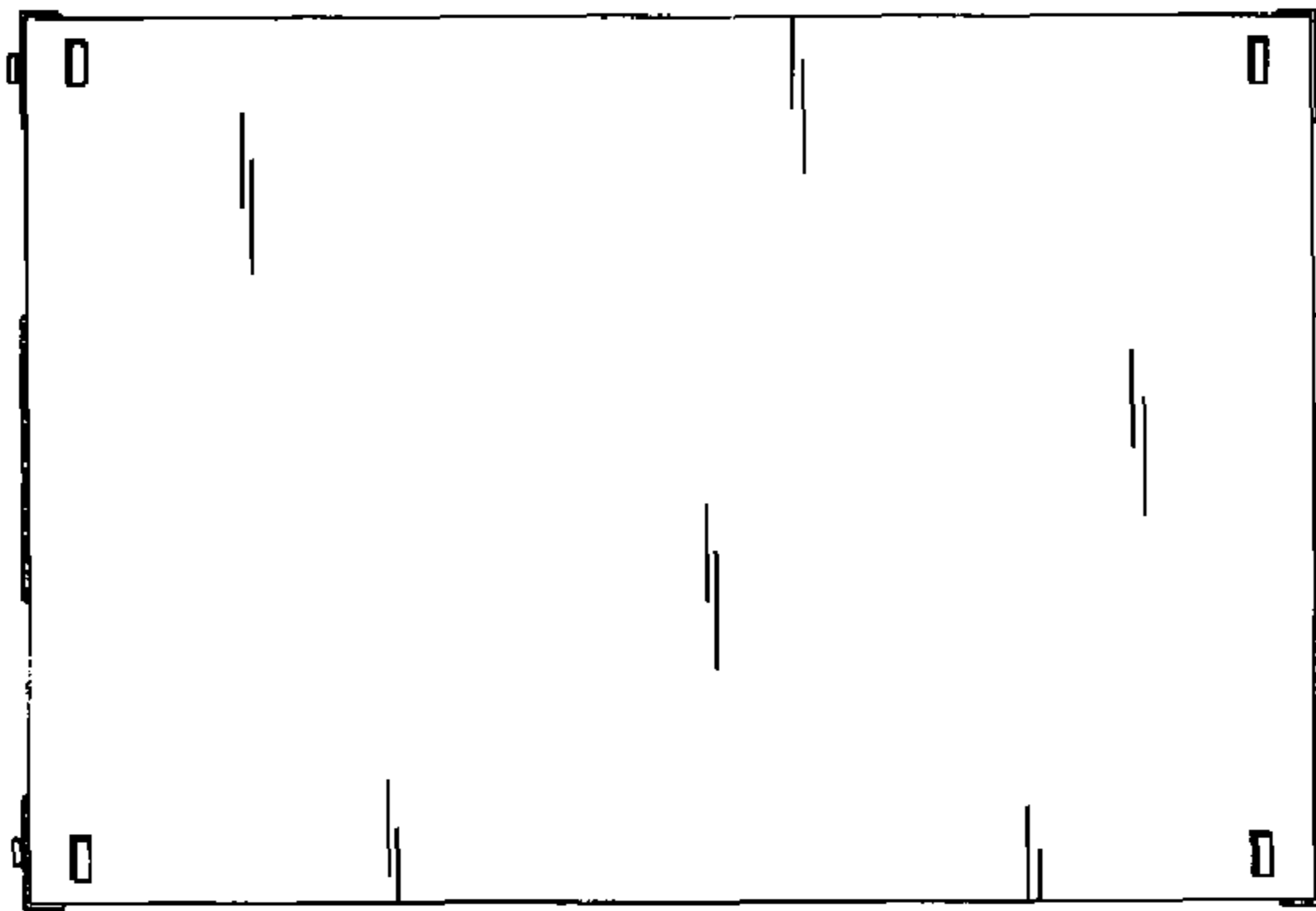

Fig. 3

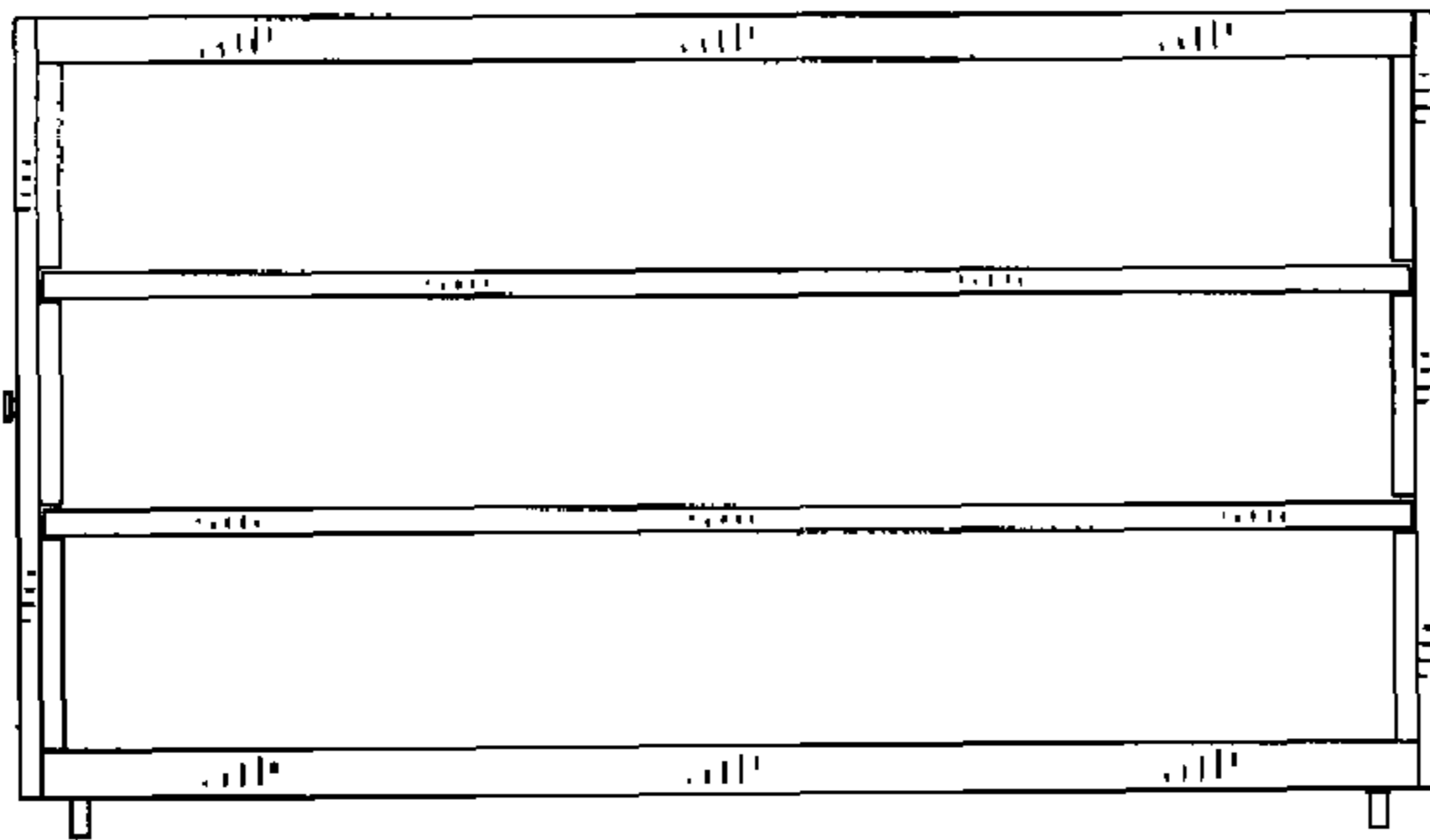

Fig. 4

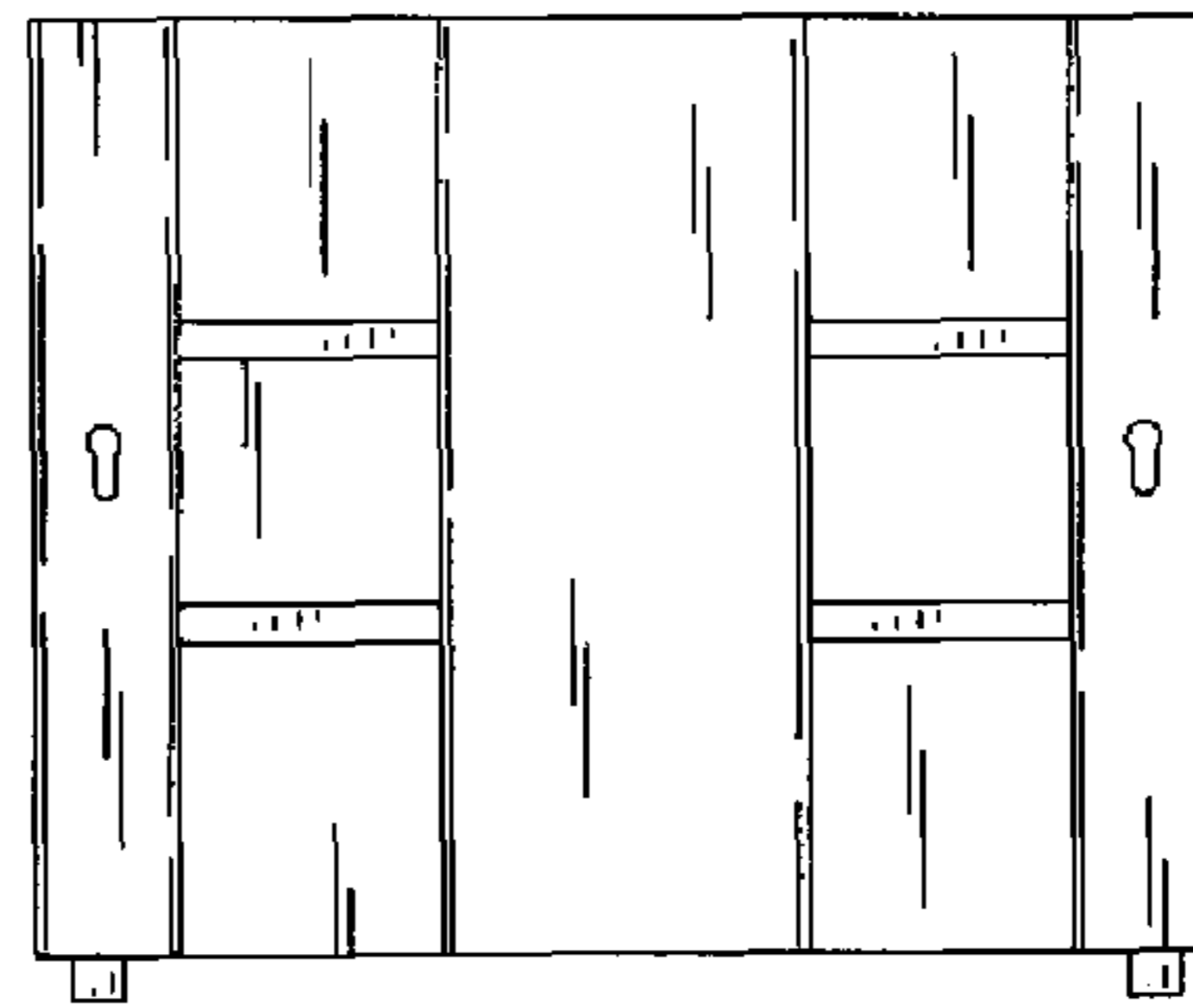

Fig. 5

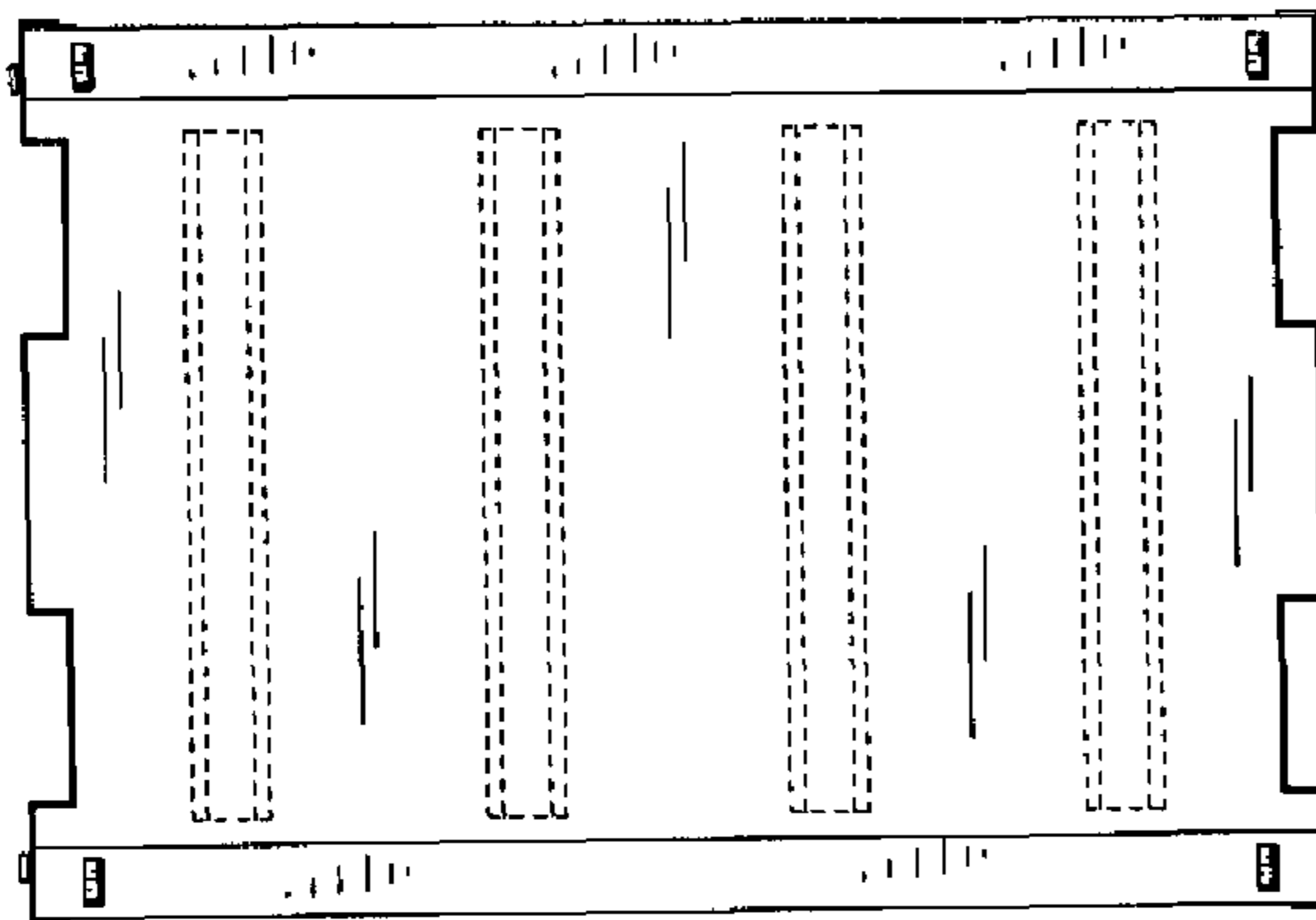

Fig. 6

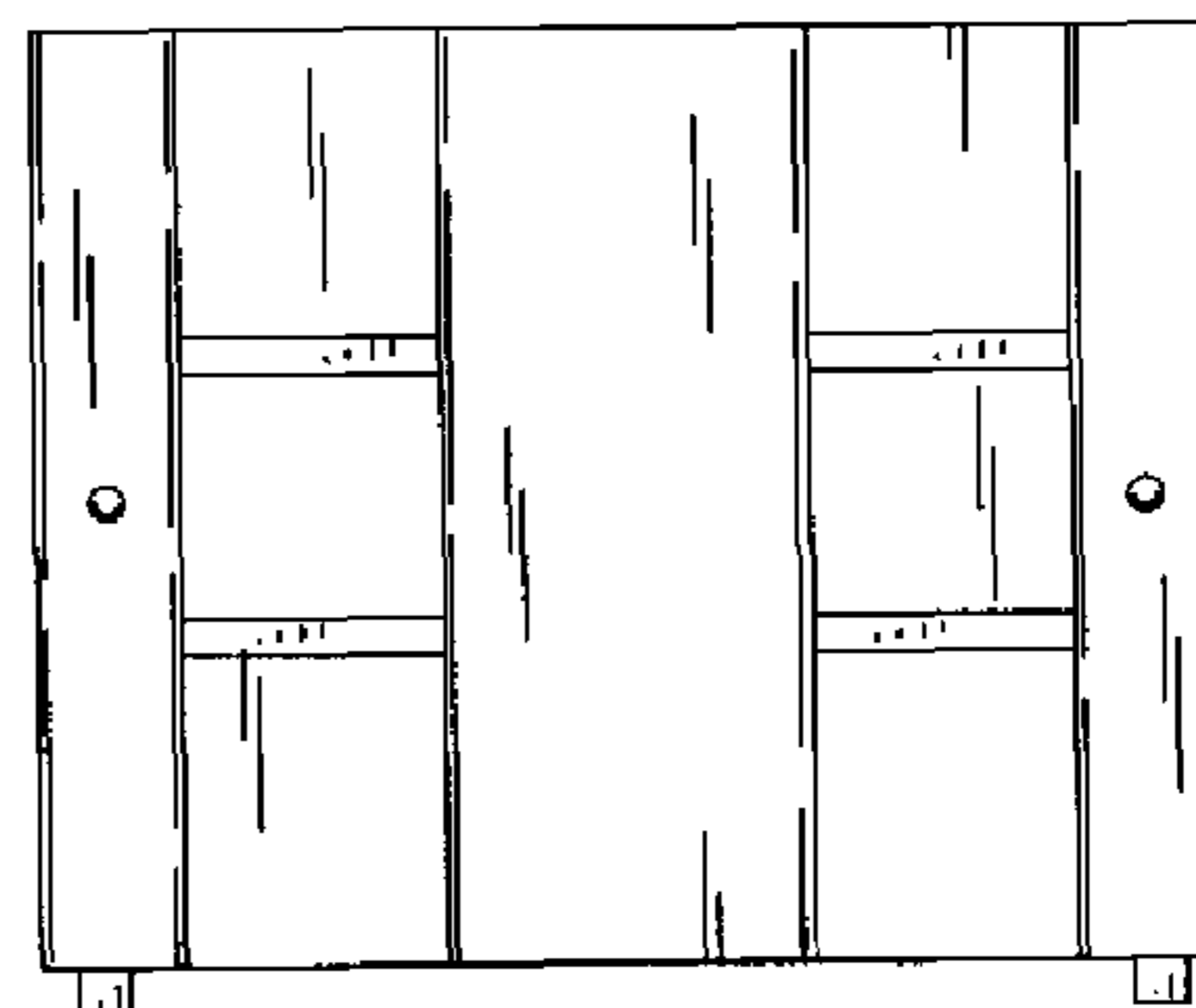

Fig. 7