



US00D618897S

(12) **United States Design Patent**
Liles

(10) **Patent No.:** **US D618,897 S**
(45) **Date of Patent:** **** Jul. 6, 2010**

(54) **SHOE**

(75) Inventor: **Timothy K. Liles**, Boston, MA (US)

(73) Assignee: **Converse, Inc.**, North Andover, MA (US)

(**) Term: **14 Years**

(21) Appl. No.: **29/358,439**

(22) Filed: **Mar. 26, 2010**

Related U.S. Application Data

(63) Continuation of application No. 11/536,353, filed on Sep. 28, 2006.

(51) **LOC (9) Cl.** **02-99**

(52) **U.S. Cl.** **D2/972**

(58) **Field of Classification Search** D2/896,
D2/902, 906-908, 943, 944, 969, 972-974,
D2/975; 36/45-49, 50.1, 77 M, 77 R, 83,
36/88, 113, 114, 126-131
See application file for complete search history.

(56) **References Cited**

U.S. PATENT DOCUMENTS

| | | | | |
|-----------|-----|---------|--------------|--------|
| 1,743,689 | A | 1/1930 | Scrogins | |
| 1,986,580 | A | 1/1935 | Johnson | |
| 2,074,697 | A | 3/1937 | Kimpton | |
| D114,917 | S * | 5/1939 | Cairns | D2/902 |
| D114,918 | S * | 5/1939 | Cairns | D2/902 |
| D117,330 | S * | 10/1939 | Cairns | D2/902 |
| D128,519 | S * | 7/1941 | Hard | D2/902 |
| D148,451 | S * | 1/1948 | Campagna | D2/902 |
| D148,519 | S * | 2/1948 | Campagna | D2/973 |
| 2,444,428 | A | 7/1948 | Carrier | |
| D155,816 | S * | 11/1949 | Little | D2/902 |
| D157,034 | S * | 1/1950 | Eldon | D2/902 |
| 2,531,763 | A | 11/1950 | Andre | |
| 2,591,211 | A | 4/1952 | Spencer | |
| D173,030 | S * | 9/1954 | Hoza | D2/902 |
| 3,837,098 | A | 9/1974 | Rathmell | |
| 4,571,856 | A | 2/1986 | Lin et al. | |
| D296,722 | S | 7/1988 | Brown et al. | |

| | | | |
|----------|---|---------|--------|
| D345,451 | S | 3/1994 | Teague |
| D346,478 | S | 5/1994 | Teague |
| D347,109 | S | 5/1994 | Avar |
| D348,764 | S | 7/1994 | Teague |
| D364,499 | S | 11/1995 | Avar |
| D365,201 | S | 12/1995 | Avar |

(Continued)

OTHER PUBLICATIONS

International Search Report dated Mar. 26, 2008 for PCT/US2007/079558, pp. 1-3.

Primary Examiner—Dominic Simone

(74) *Attorney, Agent, or Firm*—Banner & Witcoff, Ltd.

(57) **CLAIM**

The ornamental design for a shoe, as shown and described.

DESCRIPTION

FIG. 1 is a lateral side view of a shoe showing my new design;

FIG. 2 is a medial side view thereof;

FIG. 3 is a rear view thereof;

FIG. 4 is a front view thereof;

FIG. 5 is a lateral side view of the shoe of FIGS. 1-4 with the disclaimed stitching removed for clarity;

FIG. 6 is a medial side view thereof;

FIG. 7 is a rear view thereof; and,

FIG. 8 is a front view thereof.

The even broken lines within the shaded area of FIGS. 1-4 represent disclaimed stitching and form no part of the claimed design. The uneven broken lines immediately adjacent to the shaded area of FIGS. 1-8 represent unclaimed boundaries of the design.

The uneven broken line showing of remainder of the shoe in FIGS. 1-8 is for environmental purposes only and forms no part of the claimed design.

1 Claim, 6 Drawing Sheets

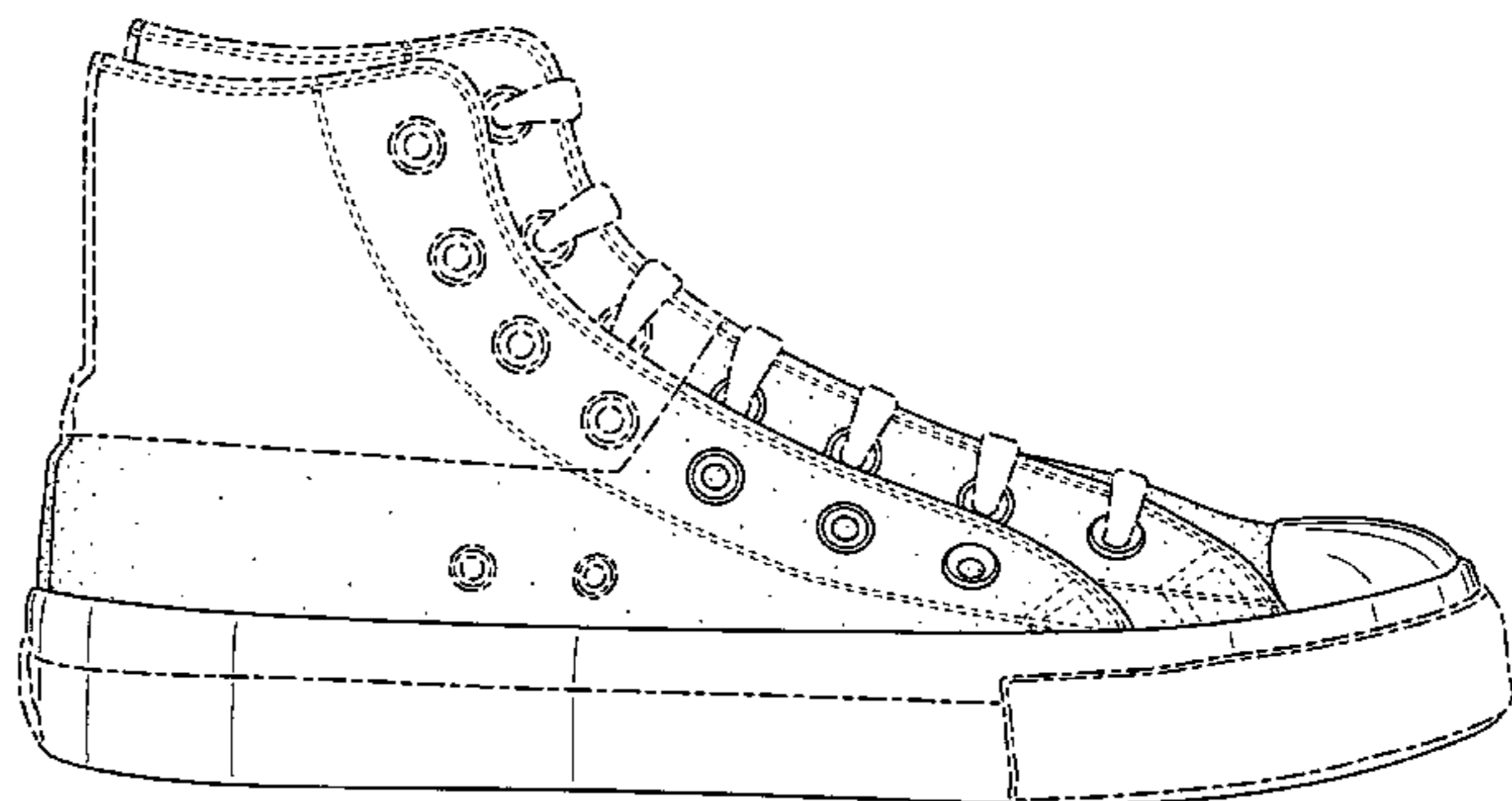
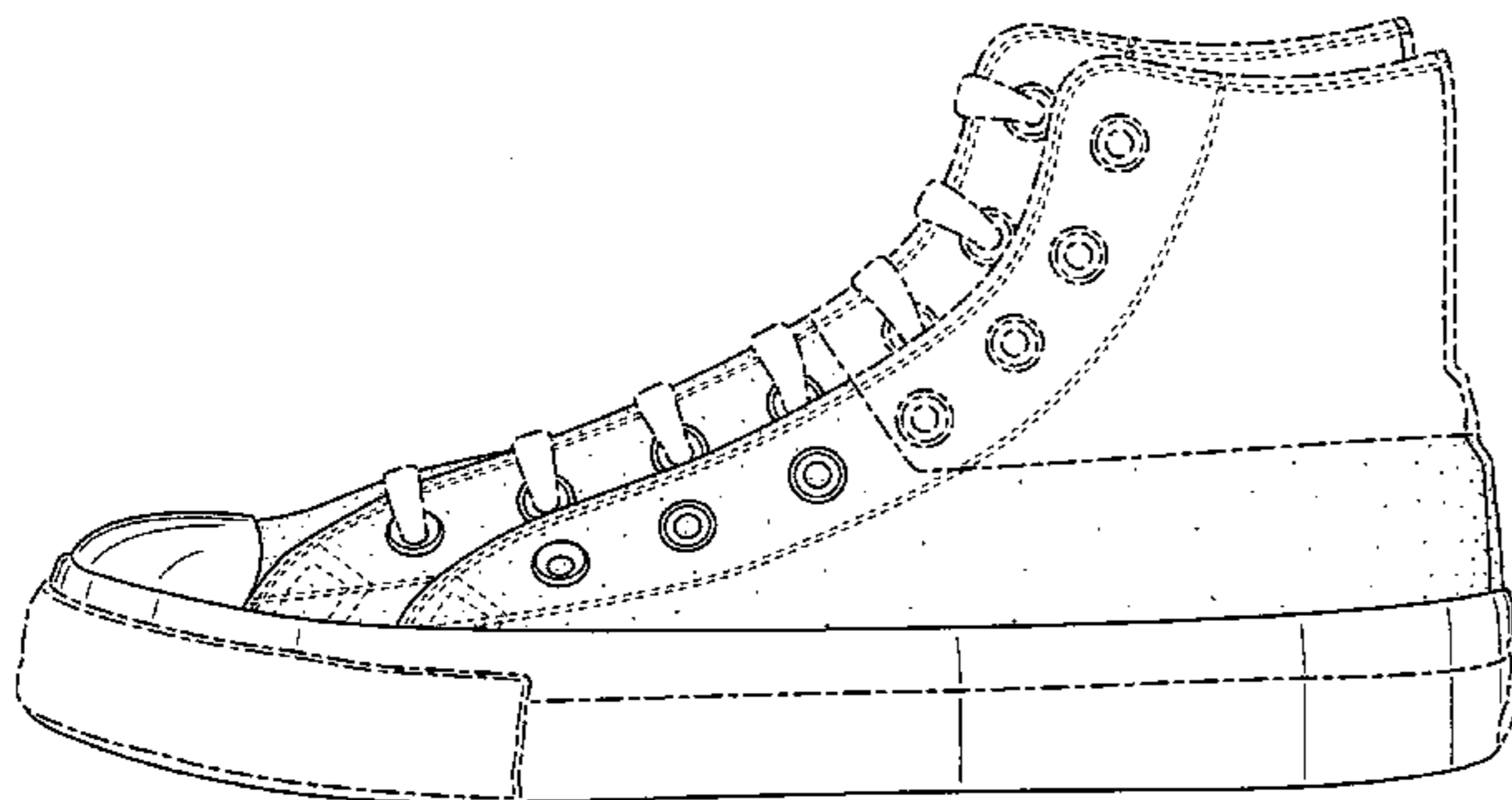

US D618,897 S

Page 2

U.S. PATENT DOCUMENTS

| | | | | | | |
|-------------|--------|------------------|--------------|---------|------------------|--------|
| D393,348 S | 4/1998 | Backus | D412,053 S | 7/1999 | Blakeslee et al. | |
| D393,349 S | 4/1998 | Backus | 7,086,181 B2 | 8/2006 | Farys | |
| 5,909,947 A | 6/1999 | DeMarchi | D555,332 S * | 11/2007 | Liles | D2/902 |
| D412,052 S | 7/1999 | Blakeslee et al. | D555,333 S * | 11/2007 | Riebesell | D2/902 |

* cited by examiner

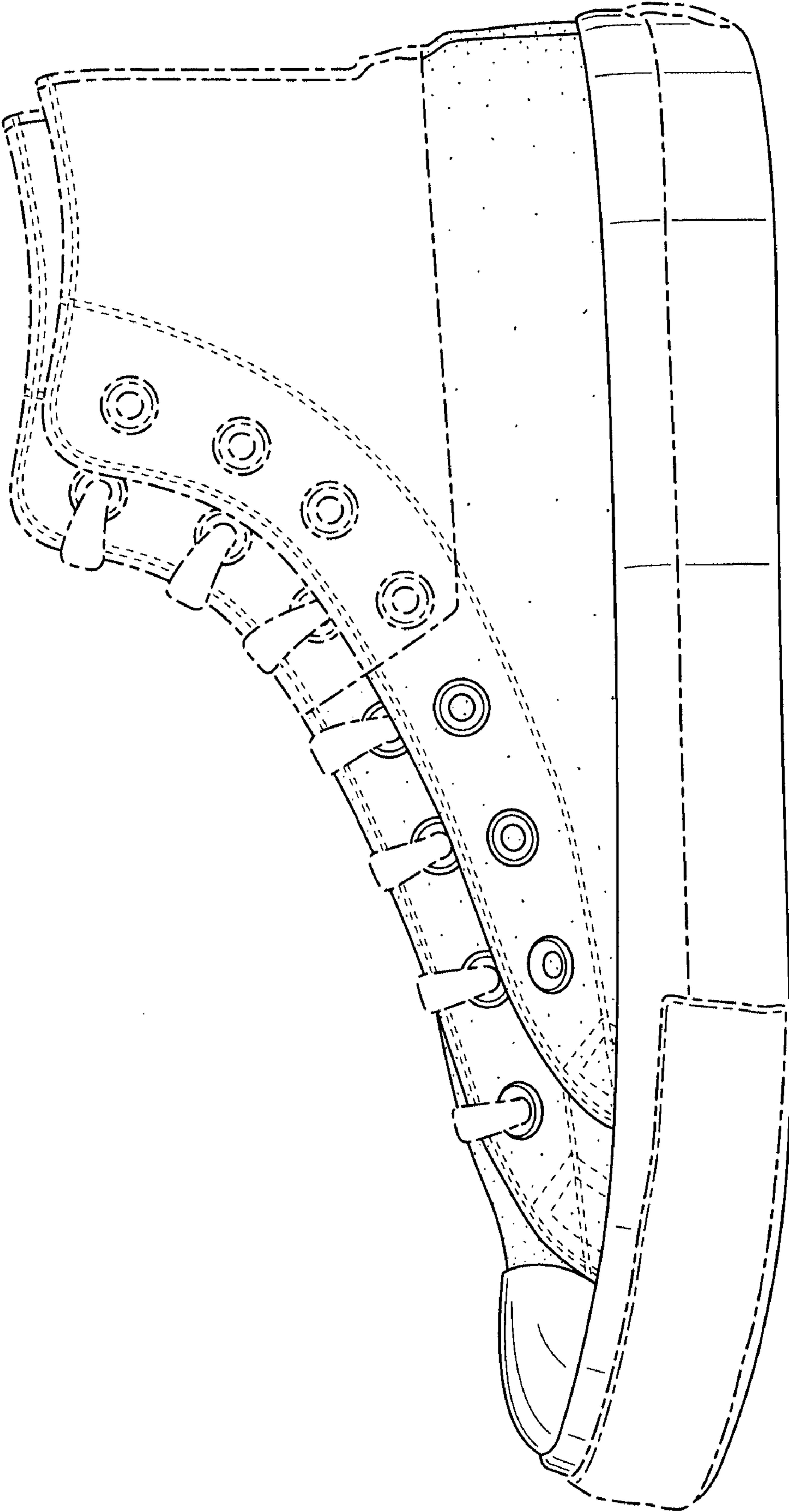

FIG. 1

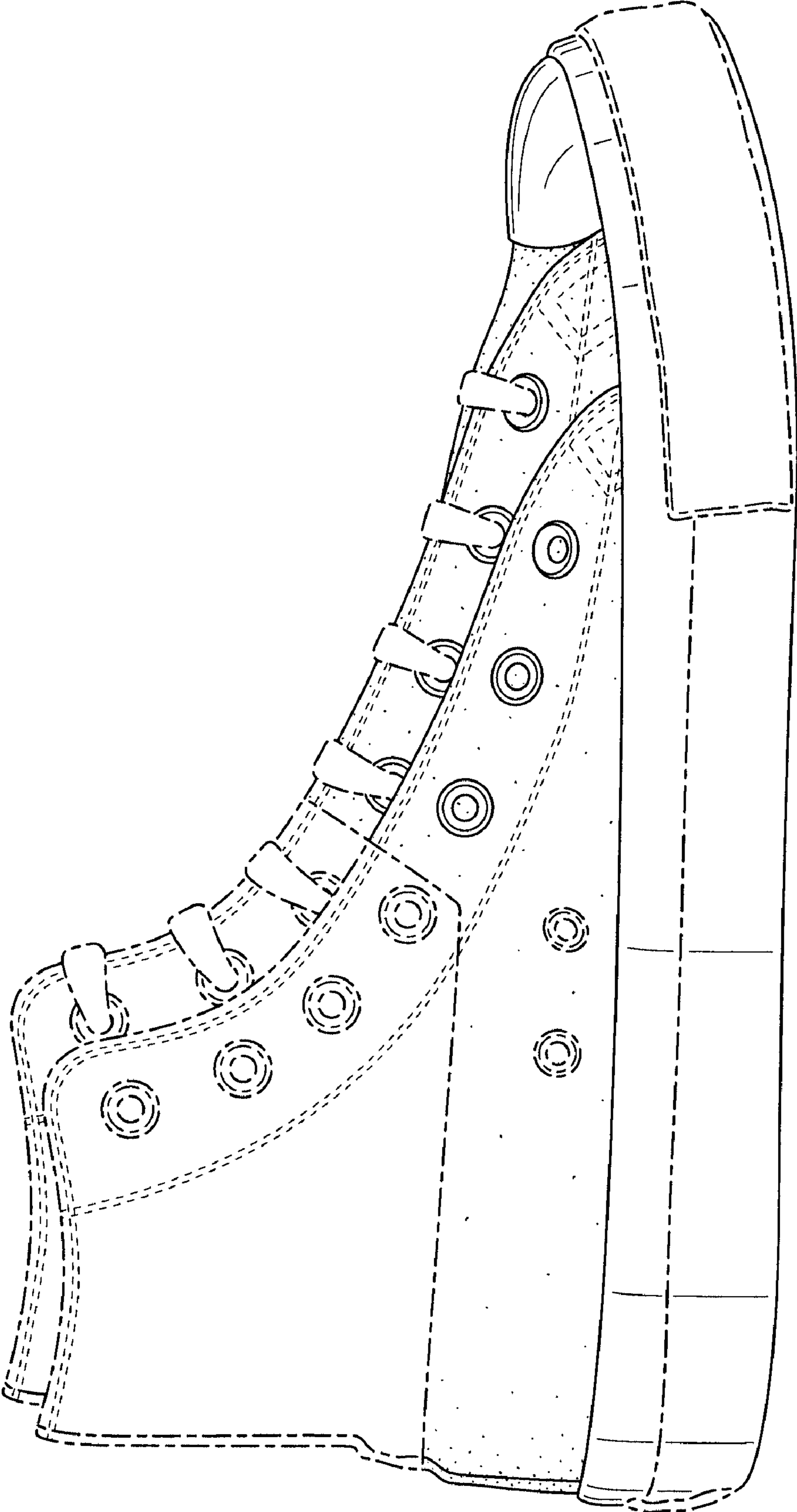

FIG. 2

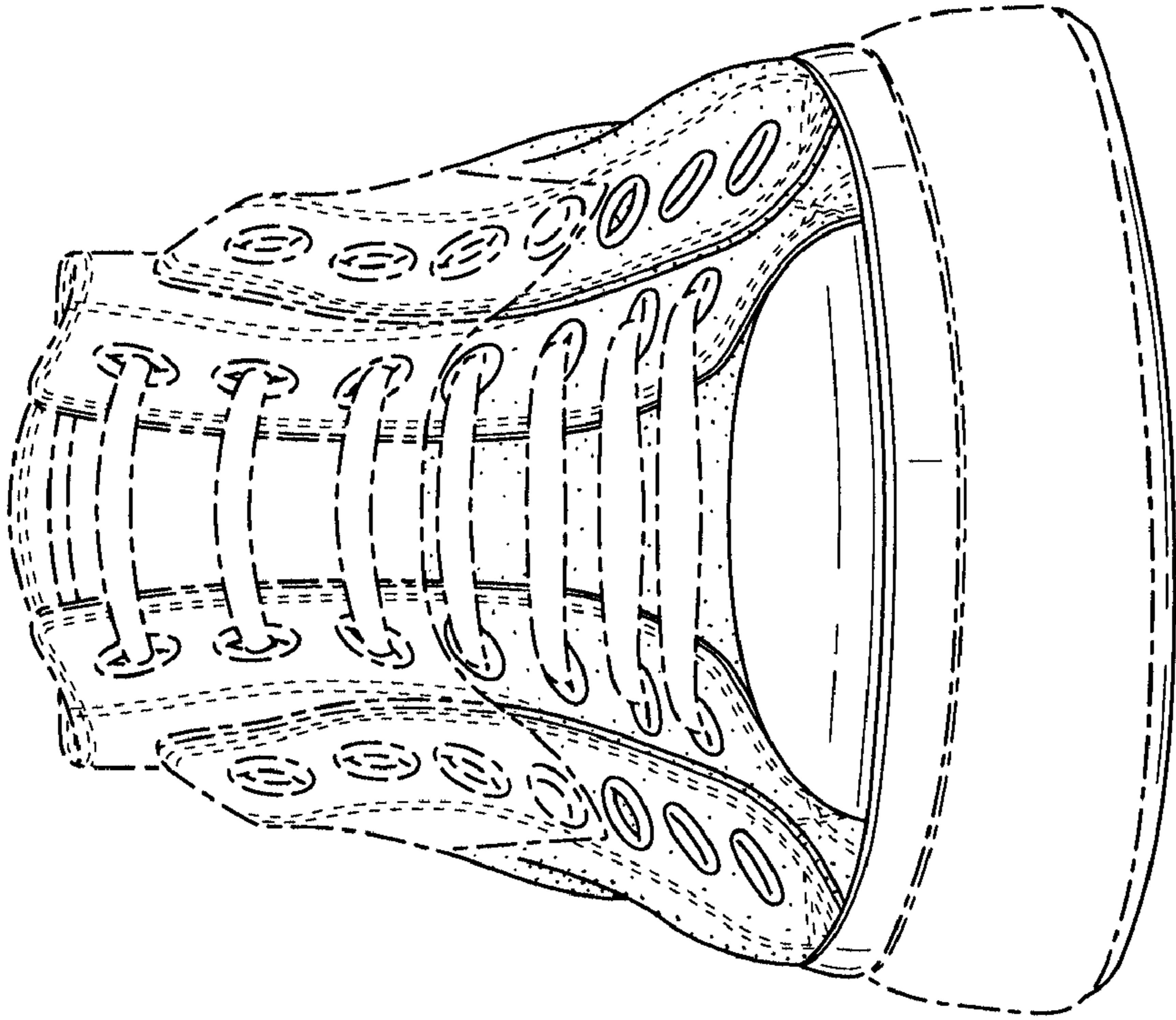

FIG. 4

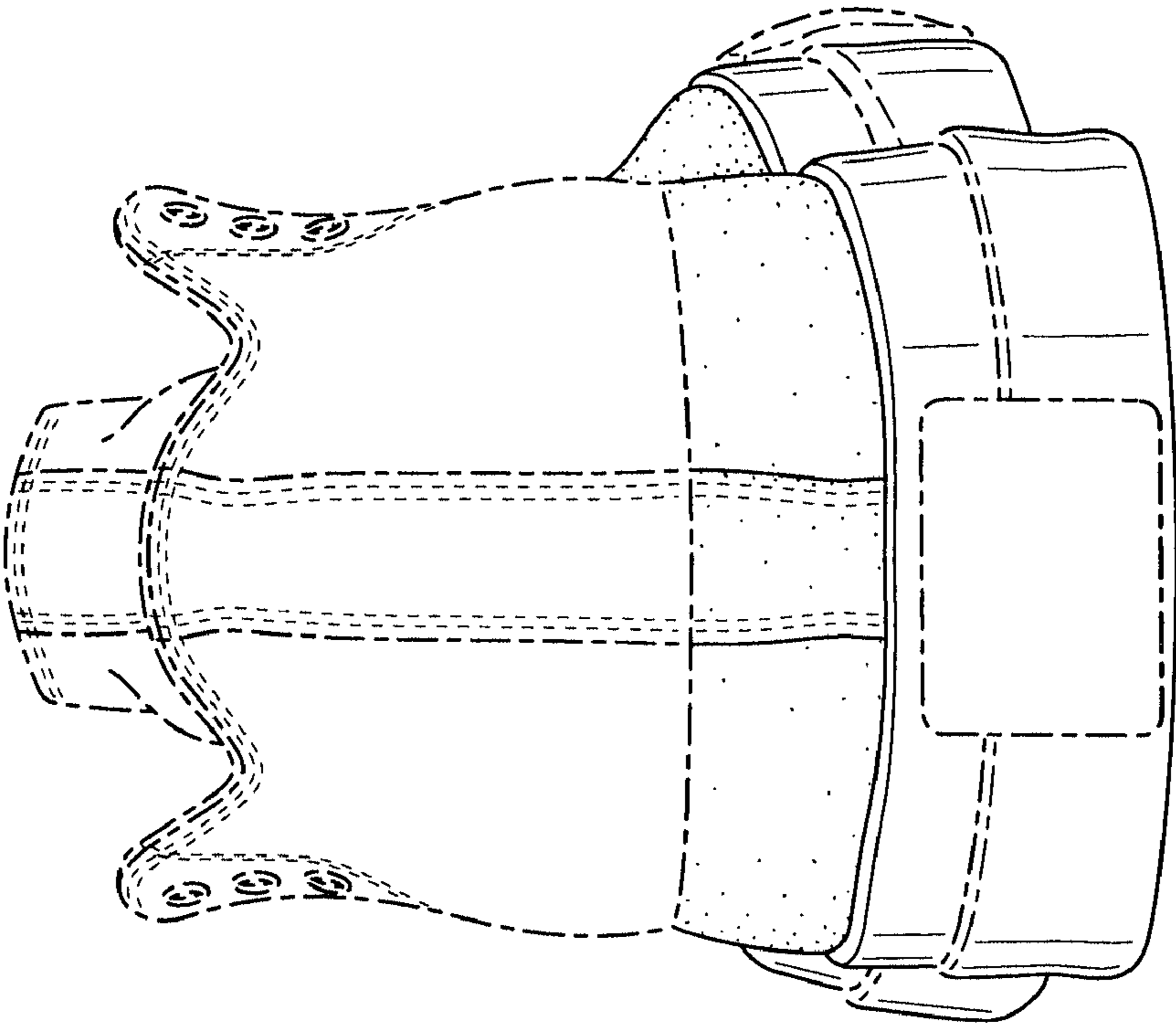

FIG. 3

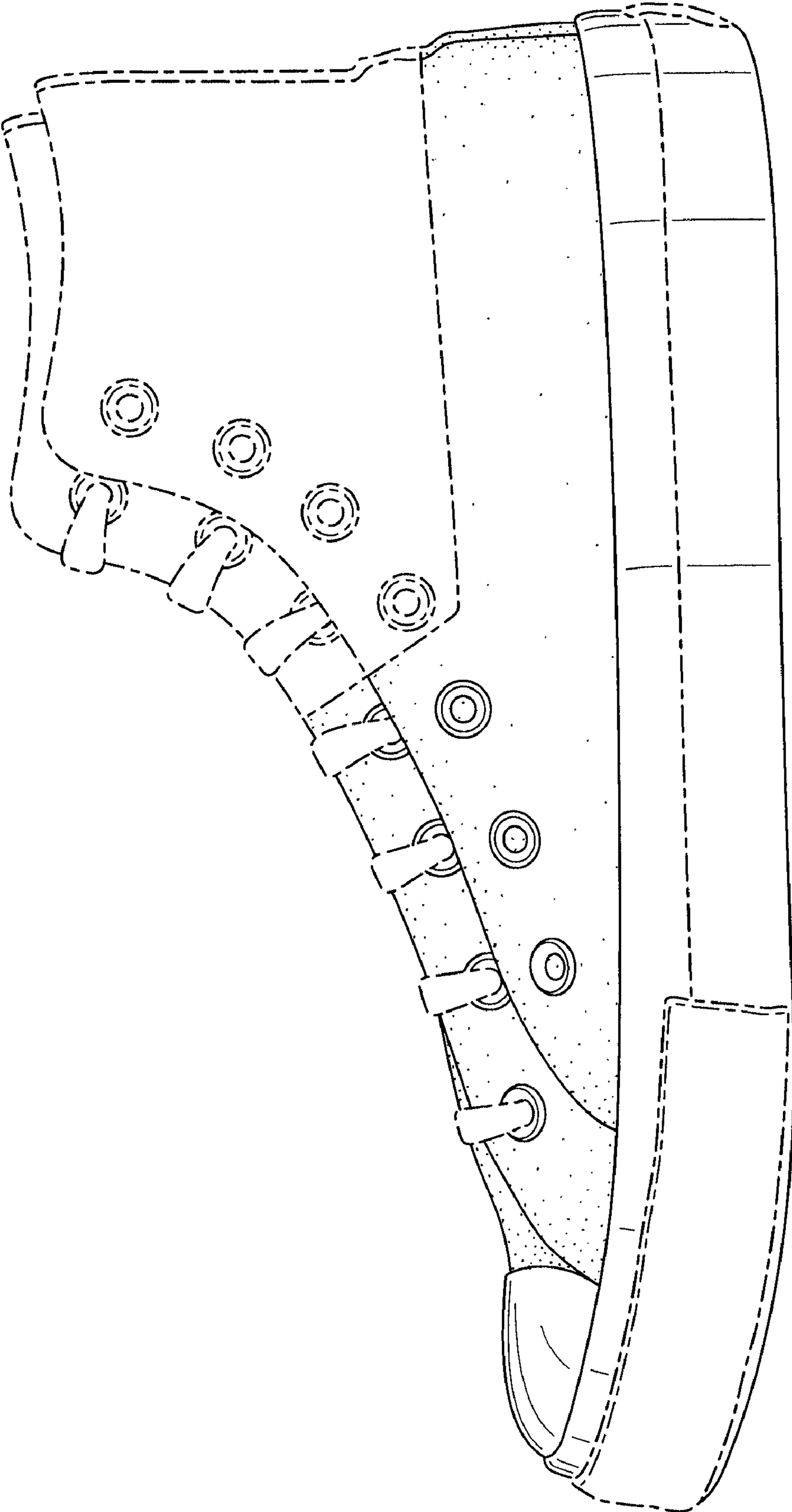

FIG. 5

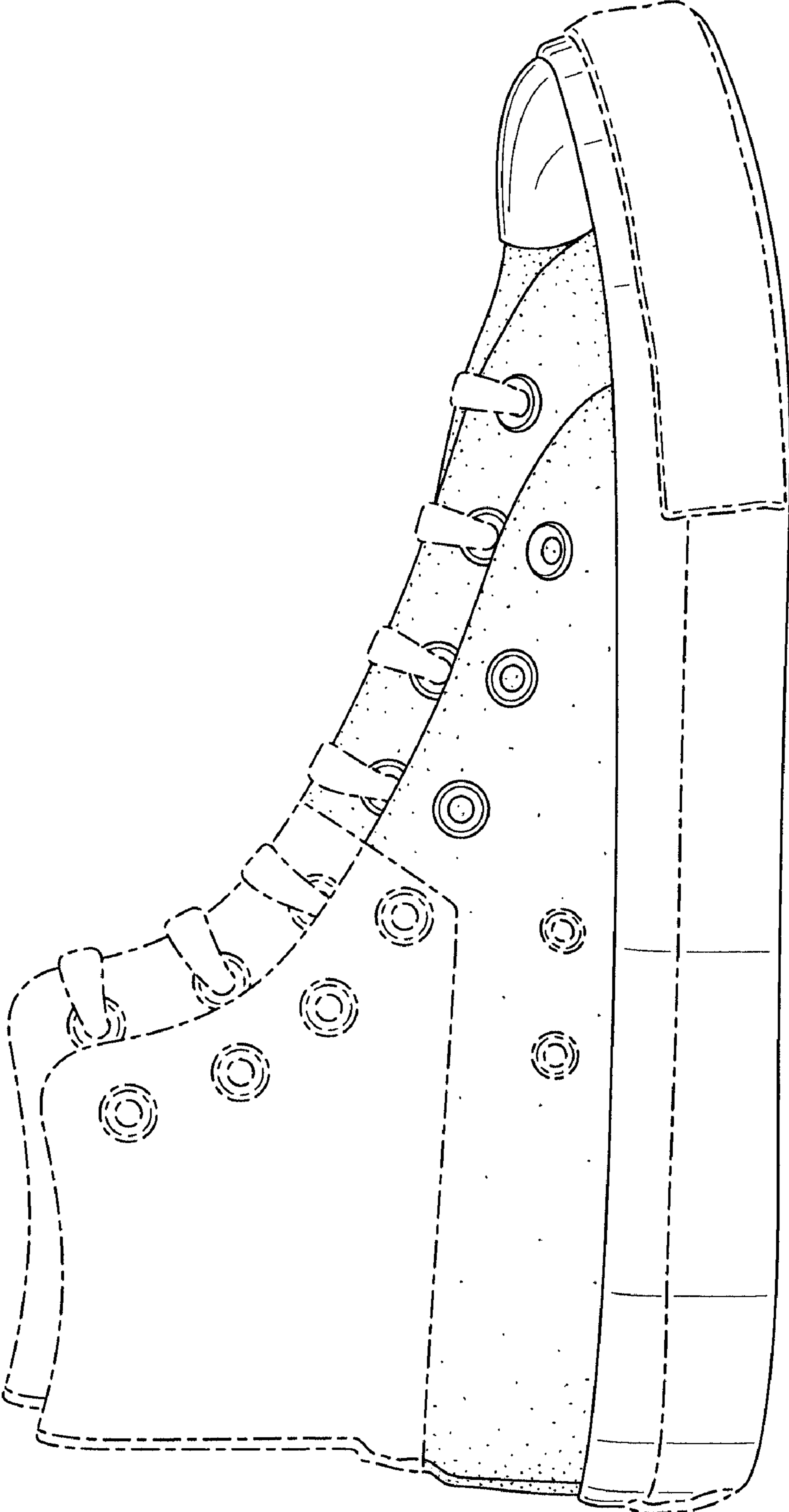

FIG. 6

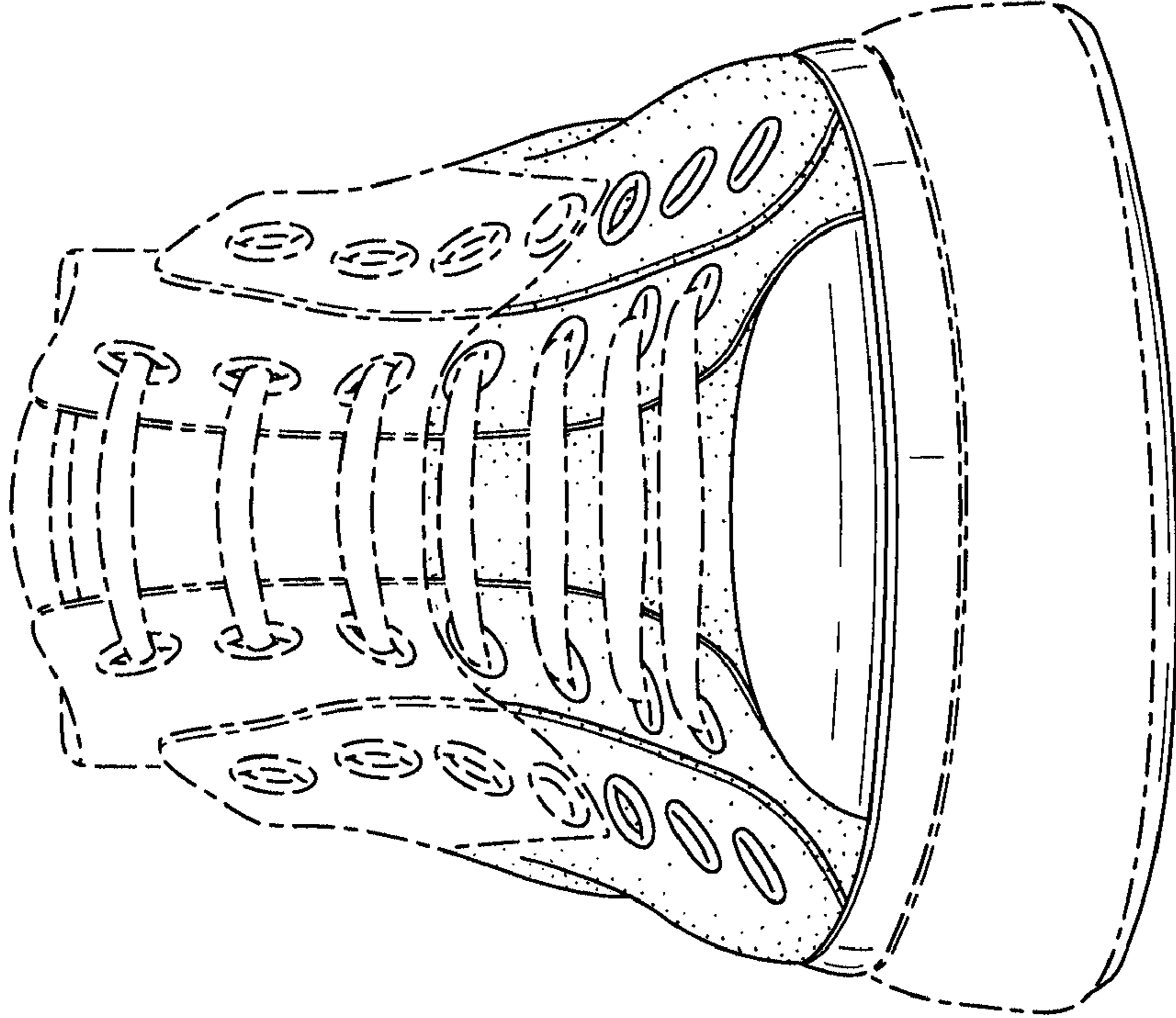

FIG. 8

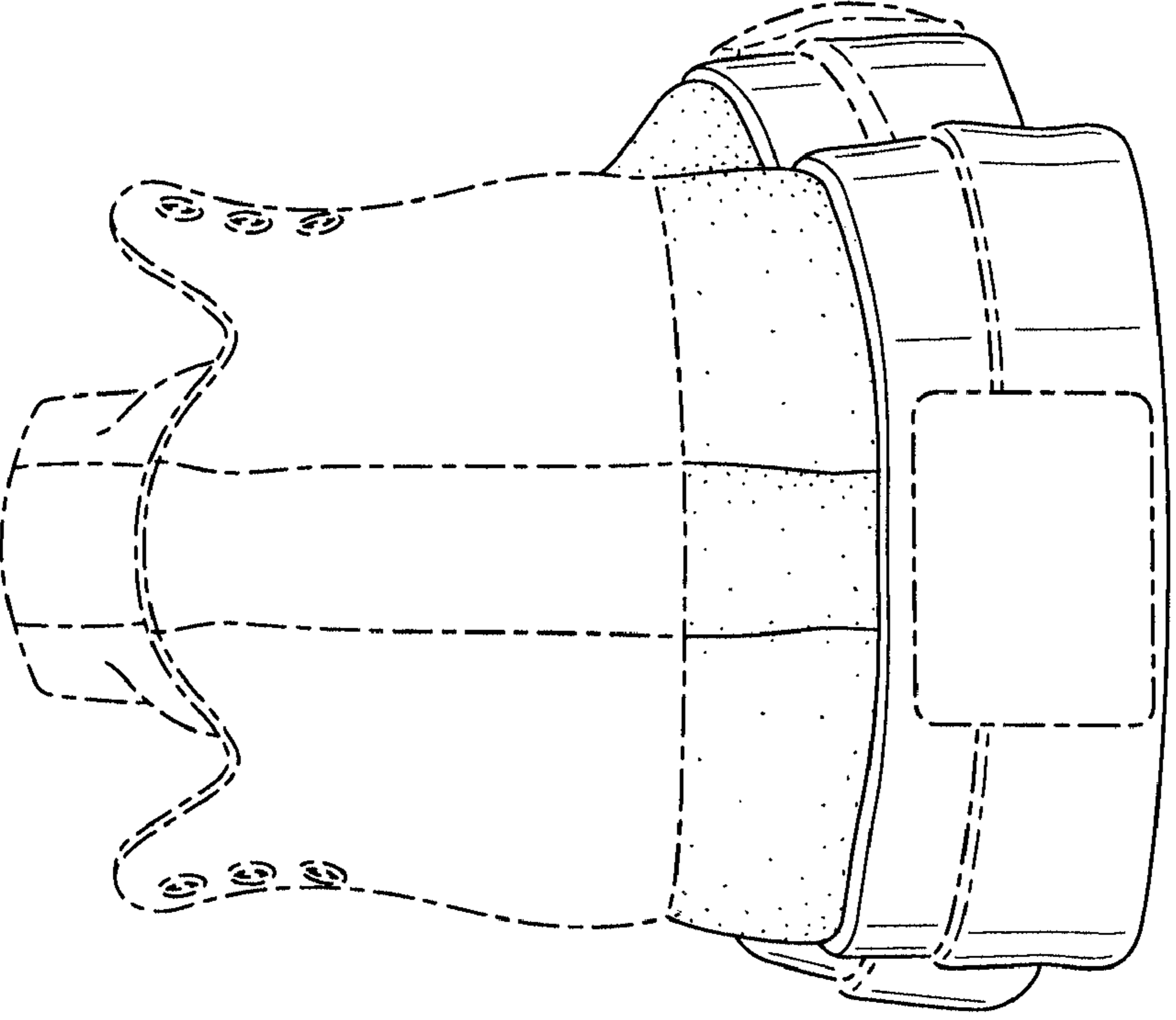

FIG. 7