



US00D618822S

(12) **United States Design Patent**
Card

(10) **Patent No.:** **US D618,822 S**
(45) **Date of Patent:** **** Jun. 29, 2010**

(54) **WINDOW**

(57) **CLAIM**

(75) **Inventor:** **Geoffrey Charles Card**, Chaska, MN
(US)

The ornamental design for a window, as shown and described.

(73) **Assignee:** **SureView, Inc.**, Cleveland, OH (US)

DESCRIPTION

(**) **Term:** **14 Years**

FIG. 1 is a front perspective view of a window showing my new design.

(21) **Appl. No.:** **29/342,073**

FIG. 2 is a rear perspective view thereof.

(22) **Filed:** **Aug. 18, 2009**

FIG. 3 is front elevation view thereof.

(51) **LOC (9) Cl.** **25-02**

FIG. 4 is rear elevation view thereof.

(52) **U.S. Cl.** **D25/52**

FIG. 5 is a side view thereof.

(58) **Field of Classification Search** D25/52;
49/504, DIG. 2; 52/202, 204.5, 204.51
See application file for complete search history.

FIG. 6 is an opposite side view thereof.

FIG. 7 is a top view thereof.

FIG. 8 is a bottom view thereof.

(56) **References Cited**

FIG. 9 is a sectional view taken at line 9—9 of FIG. 4.

FIG. 10 is a sectional view taken at line 10—10 of FIG. 4.

FIG. 11 is a perspective sectional view taken at line 11—11 of FIG. 2.

U.S. PATENT DOCUMENTS

FIG. 12 is a perspective sectional view taken at line 12—12 of FIG. 1.

2,402,247 A * 6/1946 Green 52/202

FIG. 13 is a plan sectional view of one frame extrusion of the window, which extends along the lengths of the top and bottom moveable sections of the window frame and the two opposite vertical moveable sections of the window frame; and,

4,122,633 A * 10/1978 Holdiman 49/501

FIG. 14 is a plan sectional view of another frame extrusion of the window, which extends along the lengths of the top and bottom stationary sections of the window frame and the two opposite vertical stationary sections of the window frame.

4,753,043 A * 6/1988 Bockwinkel 49/501

D394,714 S * 5/1998 Plummer D25/52

5,921,037 A * 7/1999 Minter 52/204.5

6,385,924 B1 * 5/2002 Emek 52/204.5

6,606,832 B2 * 8/2003 Richardson et al. 52/204.1

2003/0056442 A1 * 3/2003 Gerard 49/504

The broken lines in the figures are for illustrative purposes only and form no part of the claimed design.

* cited by examiner

Primary Examiner—Doris Clark
(74) *Attorney, Agent, or Firm*—Jones Day

1 Claim, 6 Drawing Sheets

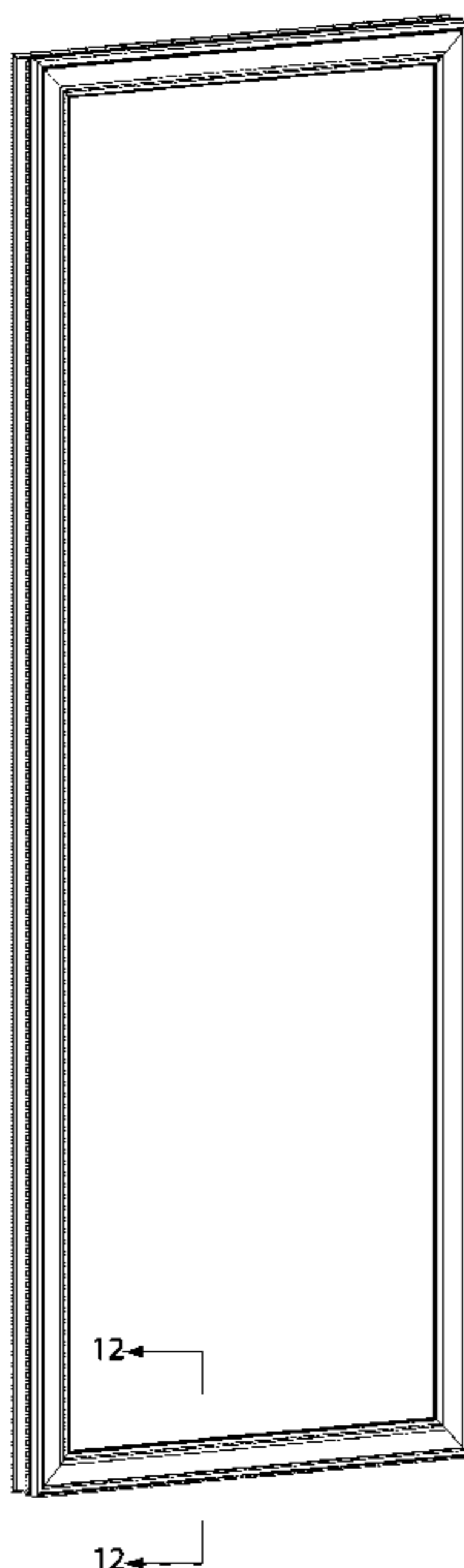

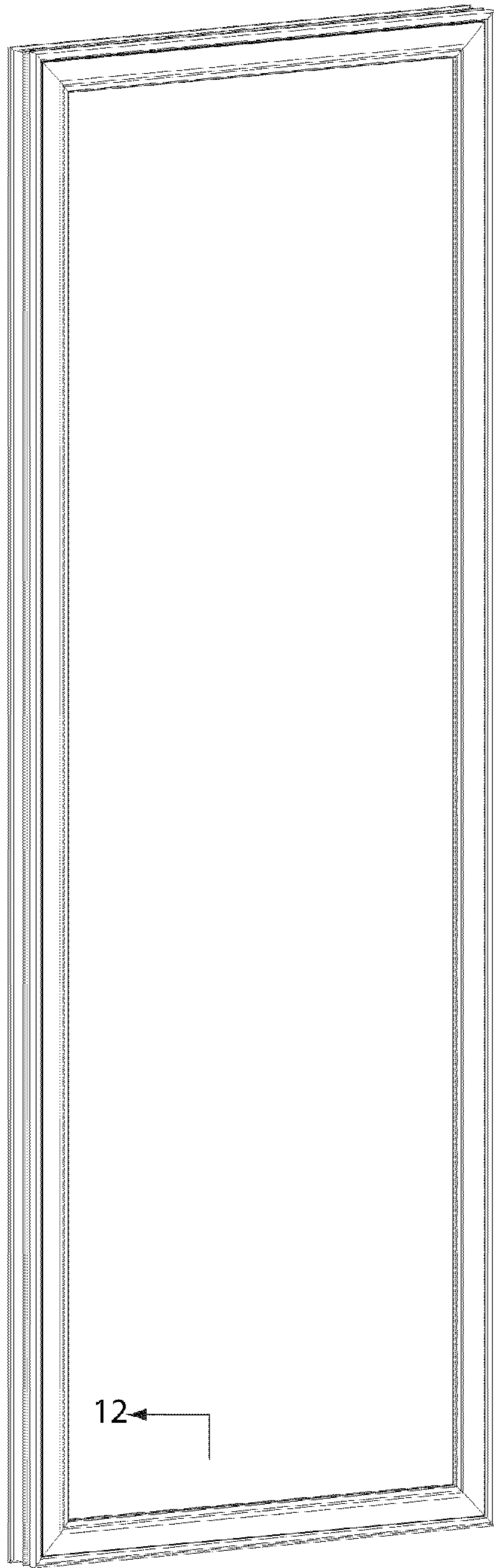

12 ← Fig. 1

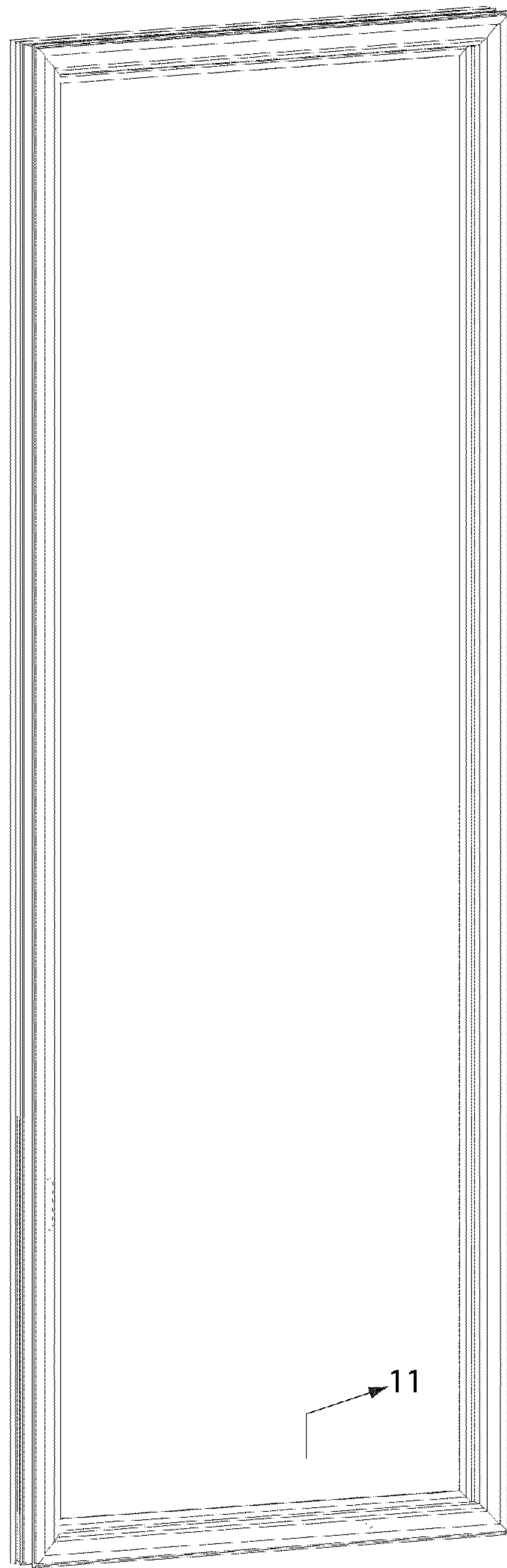

Fig. 2 → 11

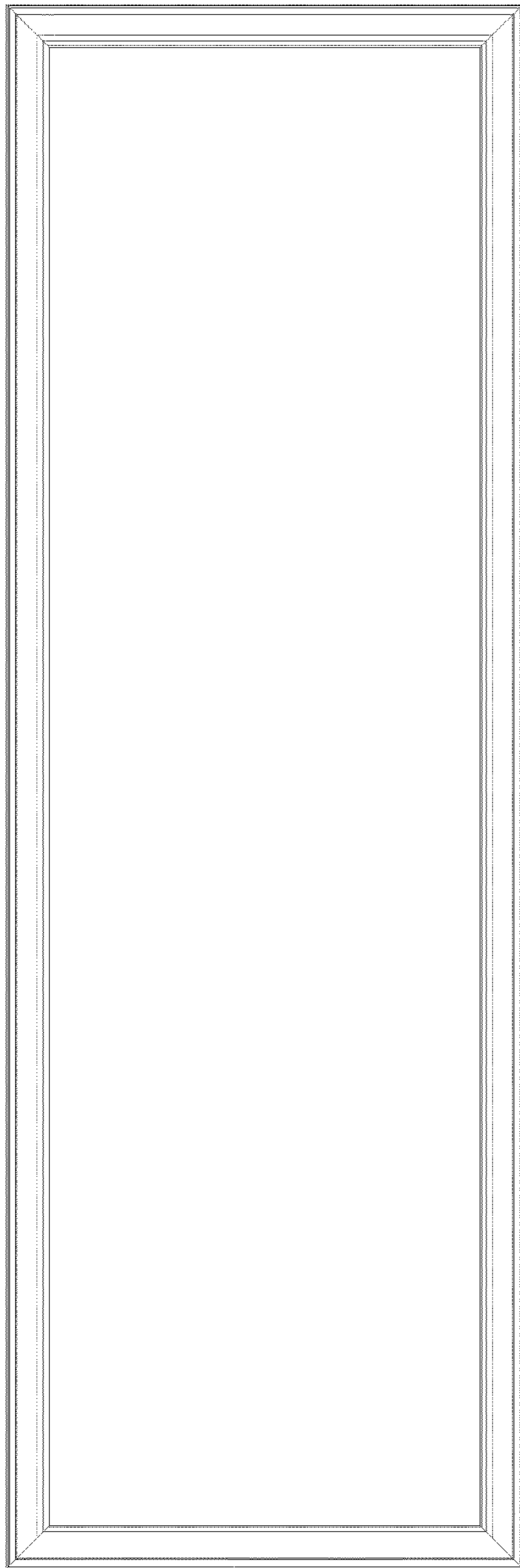

Fig. 3

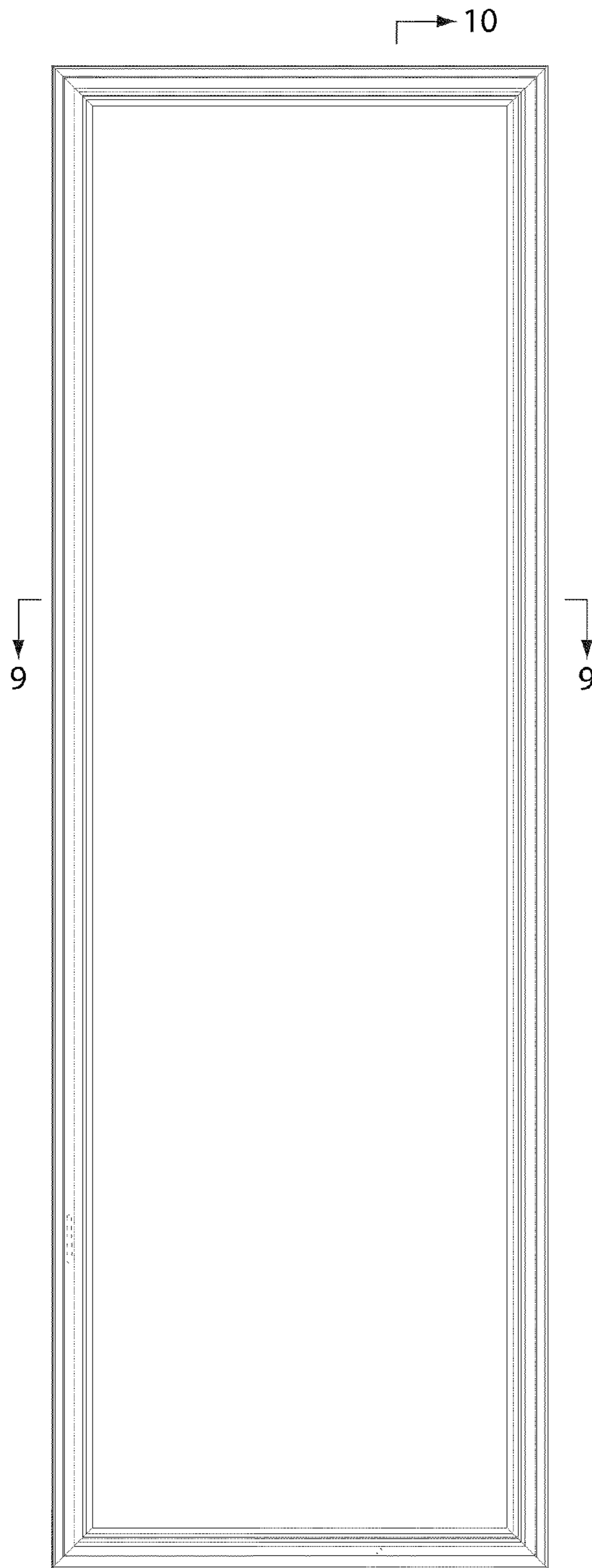

Fig. 4

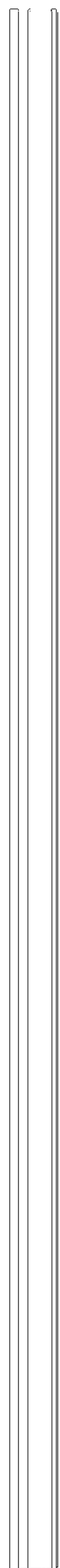

Fig. 5



Fig. 6

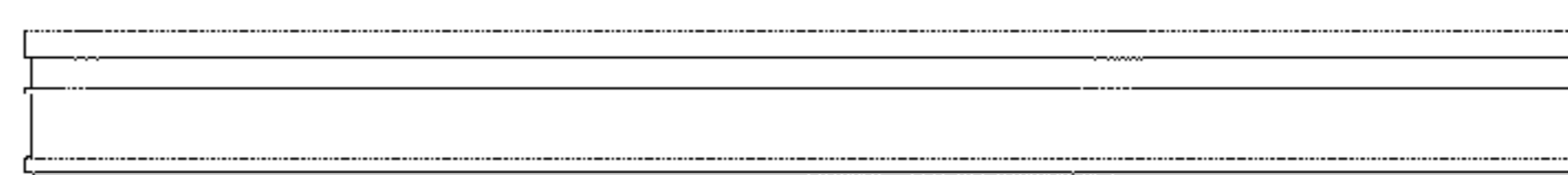

Fig. 7

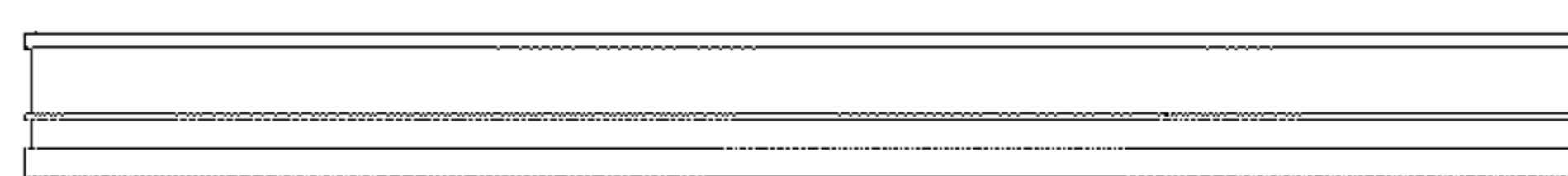

Fig. 8

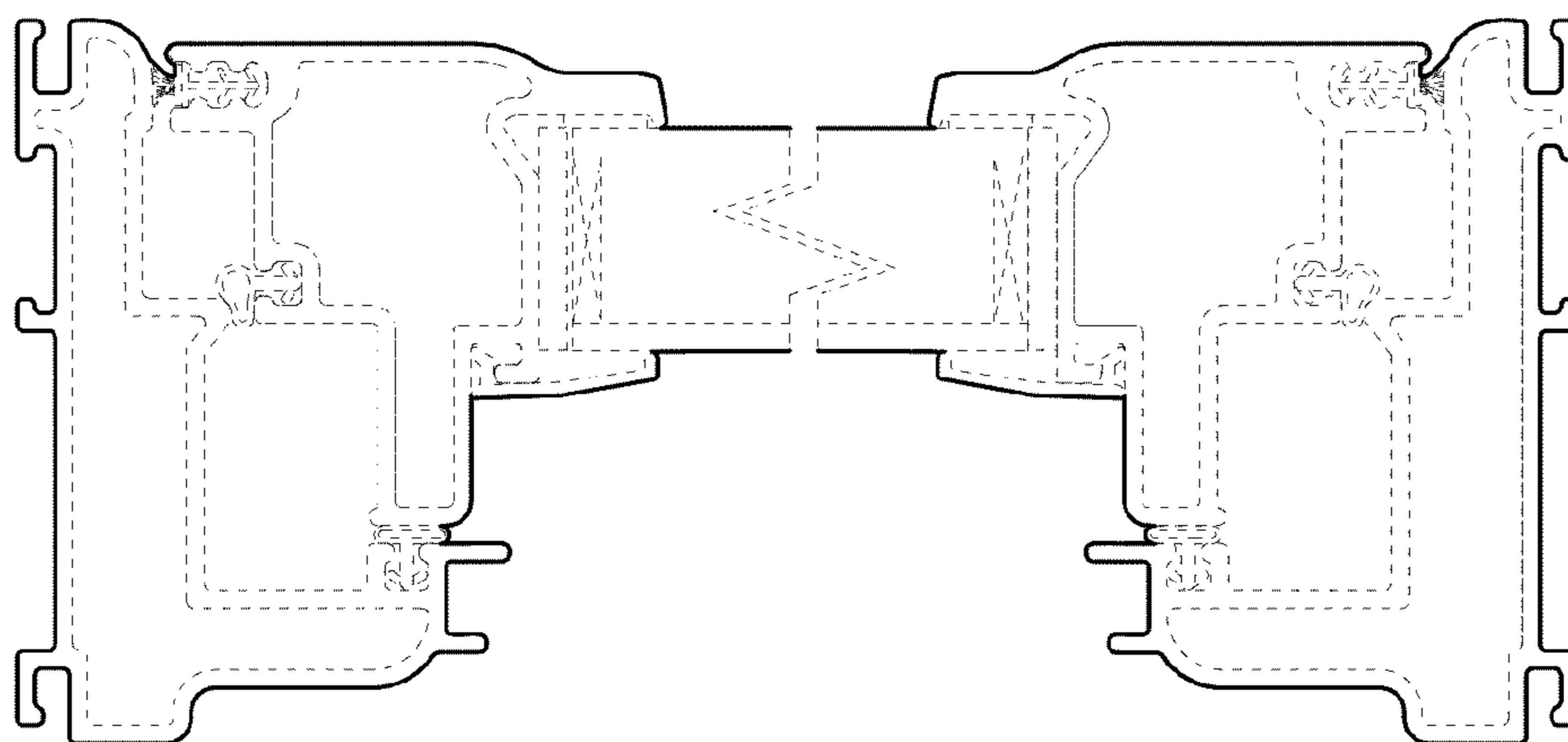

Fig. 9

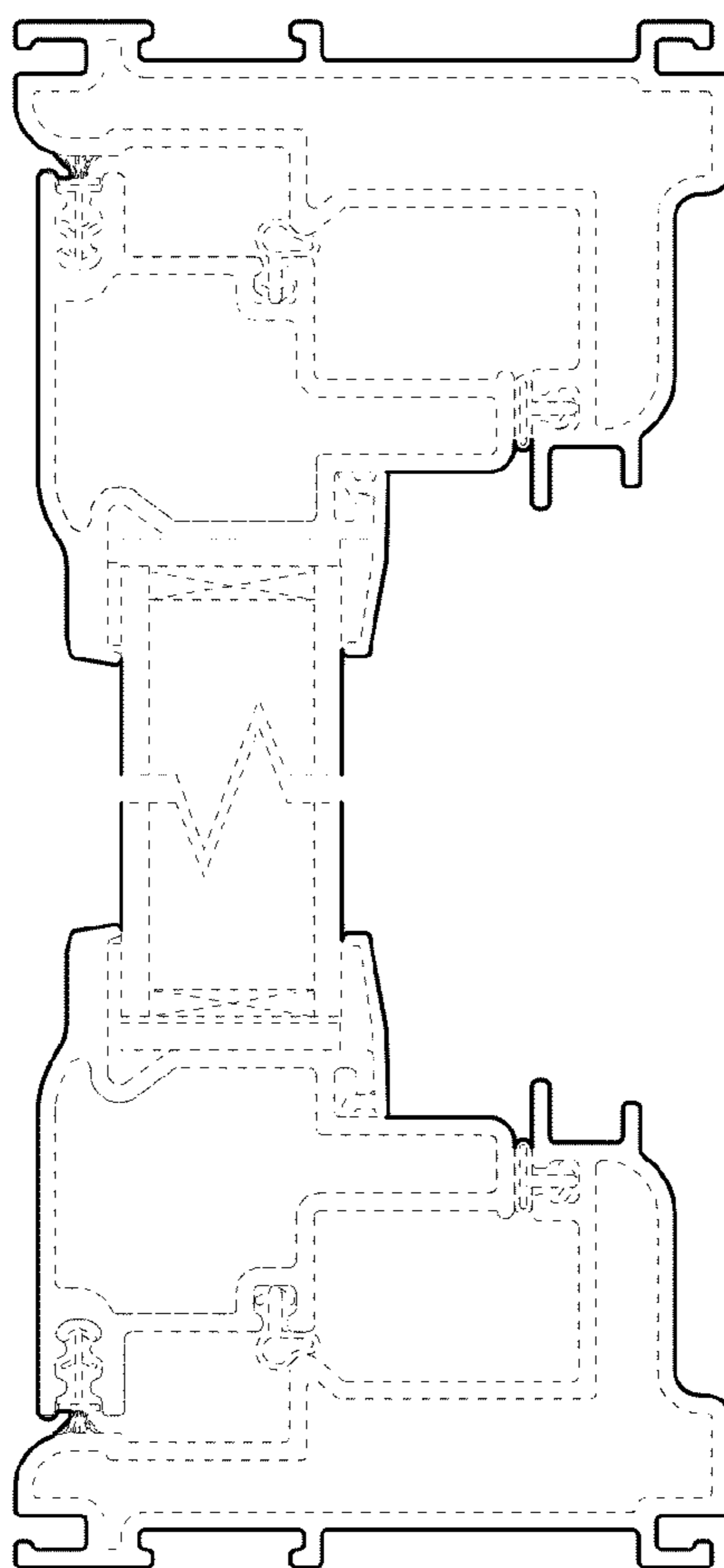

Fig. 10

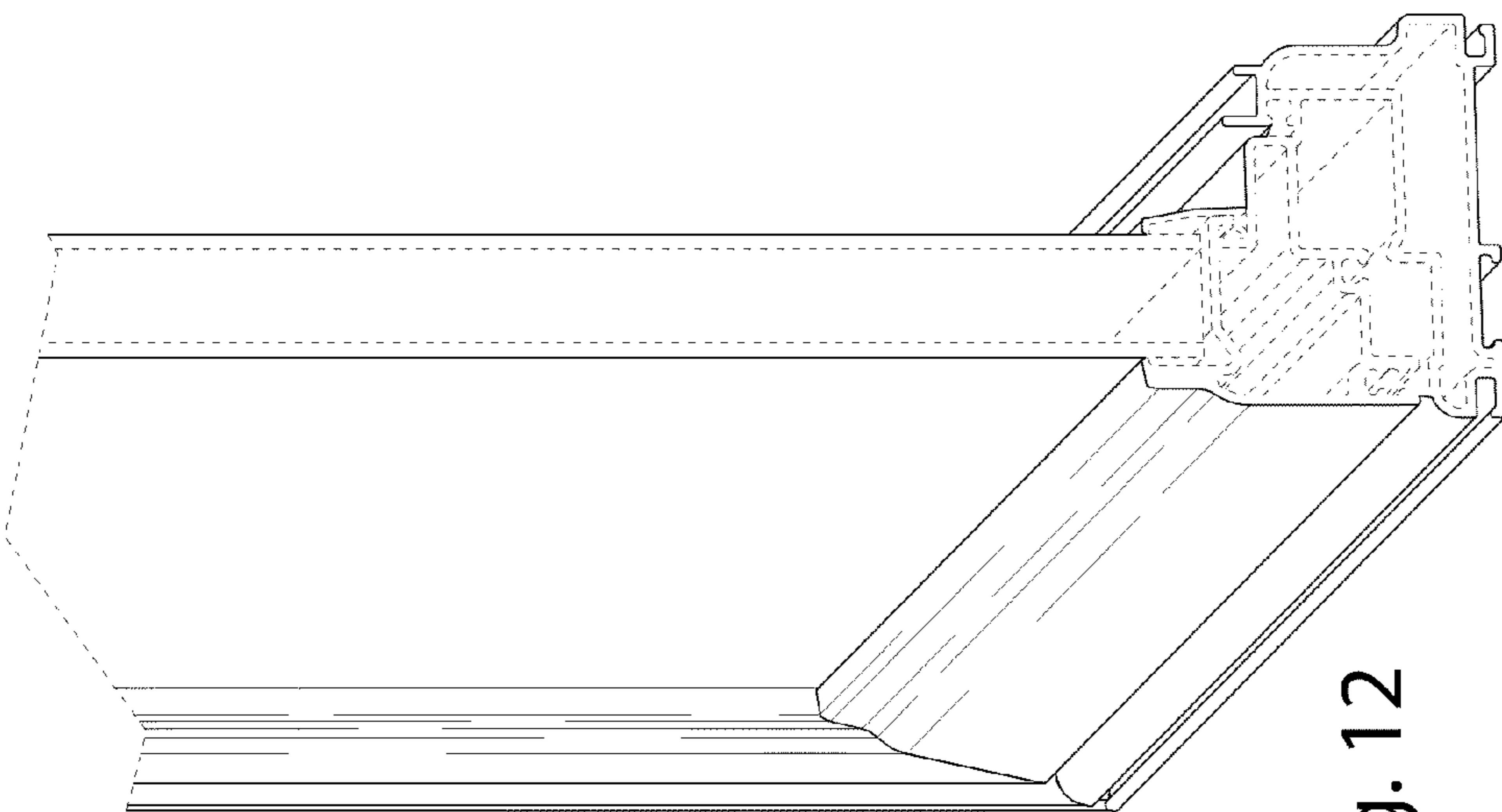

Fig. 12

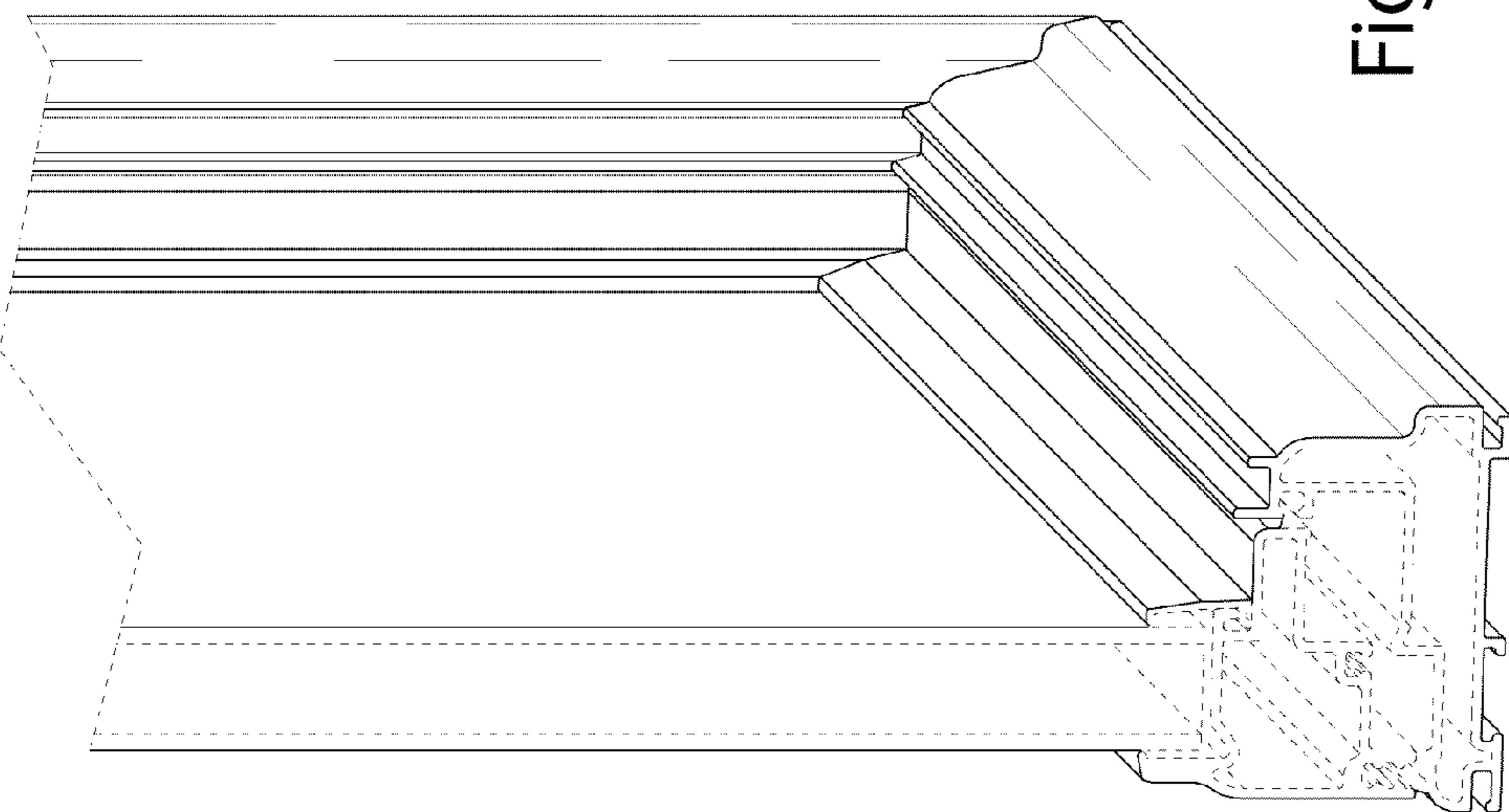

Fig. 11

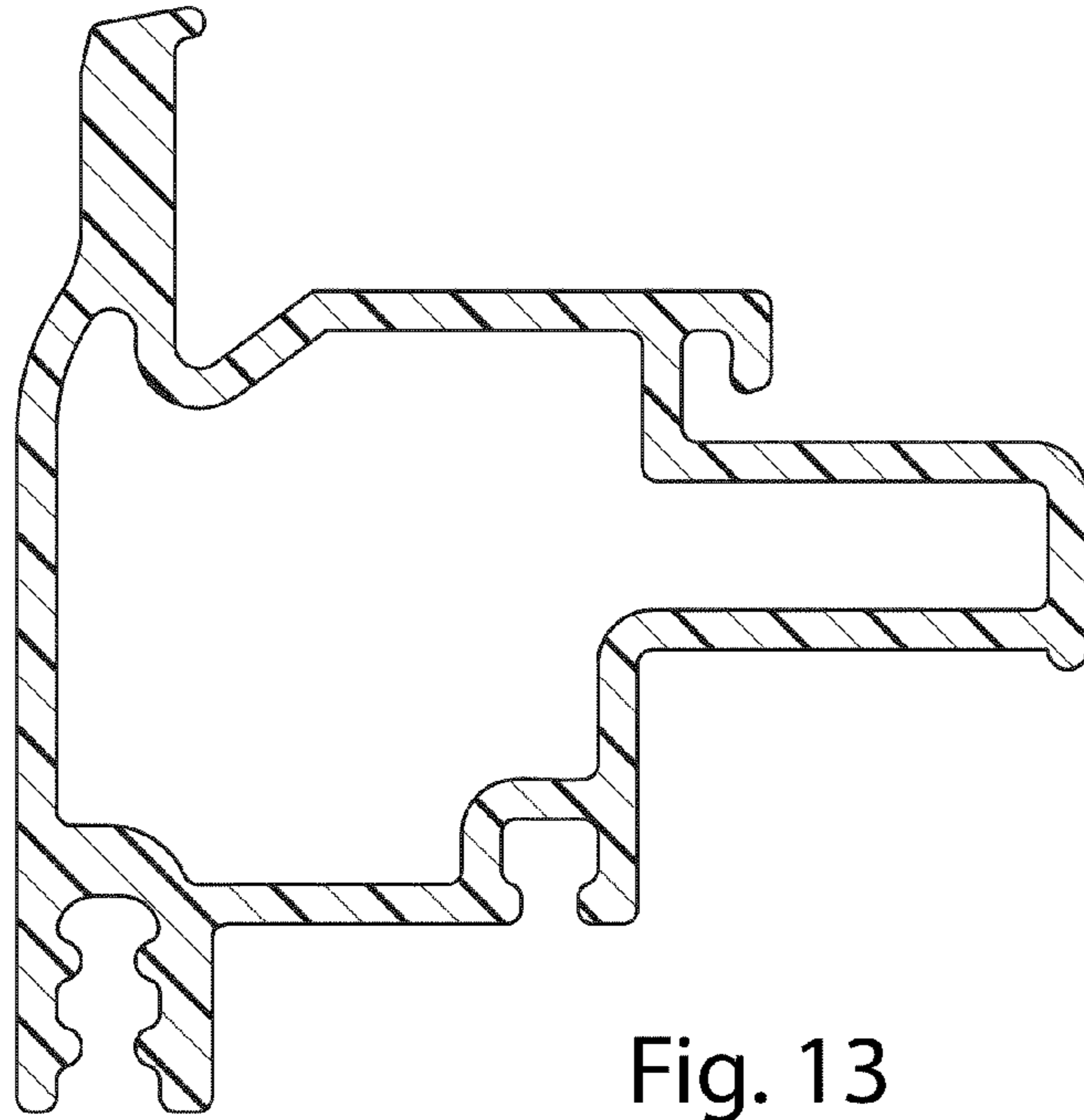

Fig. 13

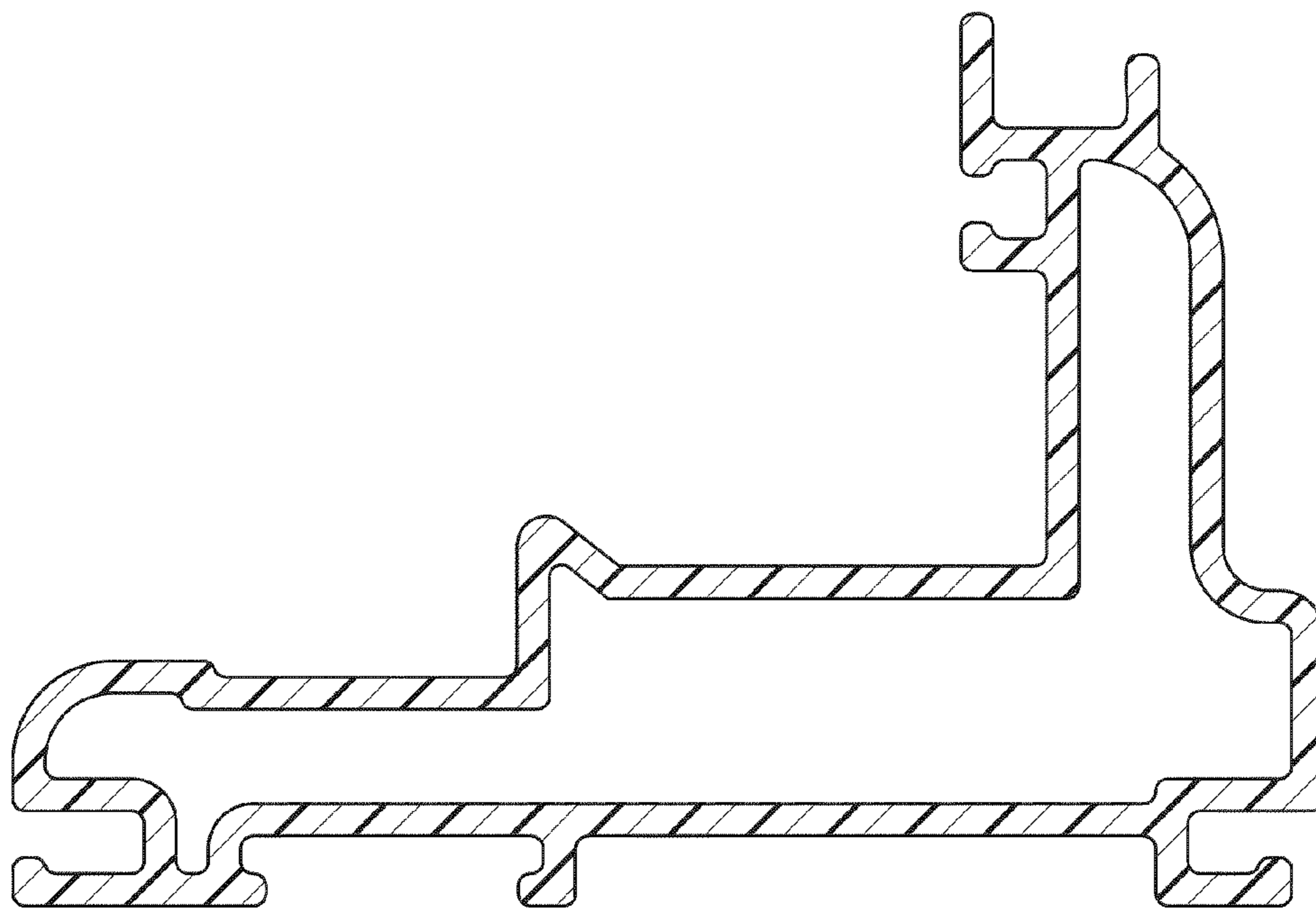

Fig. 14