



US00D618799S

(12) **United States Design Patent**  
**Plank et al.**

(10) **Patent No.:** **US D618,799 S**  
(45) **Date of Patent:** **\*\* Jun. 29, 2010**

(54) **COMBINED LIGHT HARDENING  
APPARATUS AND BASE UNIT THEREFOR**

(75) Inventors: **Wolfgang Plank**, Rankweil (AT); **Bruno Senn**, Buchs (CH); **Reinhard Goerge**, Lindau (DE)

(73) Assignee: **Ivoclar Vivadent AG**, Schaan (LI)

(\*\*) Term: **14 Years**

(21) Appl. No.: **29/315,622**

(22) Filed: **Jul. 11, 2009**

**Related U.S. Application Data**

(62) Division of application No. 29/289,369, filed on Jul. 16, 2007, now Pat. No. Des. 599,018.

(30) **Foreign Application Priority Data**

Jul. 16, 2007 (DE) ..... 4 07 00 267

(51) **LOC (9) Cl.** ..... **24-01**

(52) **U.S. Cl.** ..... **D24/152**

(58) **Field of Classification Search** ..... D24/152,  
D24/176-181; 433/173, 176, 49, 70, 168.1,  
433/141; D13/107, 108; D28/65

See application file for complete search history.

(56) **References Cited**

**U.S. PATENT DOCUMENTS**

5,098,292 A \* 3/1992 Lazarof ..... 433/141

(Continued)

*Primary Examiner*—Charles A Rademaker

(74) *Attorney, Agent, or Firm*—Alan S. Korman; John C. Thompson; Sandra J. Thompson

(57) **CLAIM**

We claim the ornamental design for a combined light hardening apparatus and base unit therefor, as shown.

**DESCRIPTION**

FIG. 1 is a perspective view of the combined light hardening apparatus and base unit therefor showing our new design;

FIG. 2 is a front elevational view of the design shown in FIG. 1;

FIG. 3 is a right side elevational view of the design shown in FIG. 1;

FIG. 4 is a top plan view of the design shown in FIG. 1;

FIG. 5 is a left side elevational view of the design shown in FIG. 1;

FIG. 6 is a rear view of the design shown in FIG. 1;

FIG. 7 is a bottom view of the design shown in FIG. 1, the structural environment being shown in broken lines;

FIG. 8 is a perspective view of the base unit of the combined light hardening apparatus and base unit therefor showing our new design;

FIG. 9 is a front elevational view of the design shown in FIG. 8;

FIG. 10 is a right side elevational view of the design shown in FIG. 8;

FIG. 11 is a top plan view of the design shown in FIG. 8;

FIG. 12 is a left side elevational view of the design shown in FIG. 8;

FIG. 13 is a bottom view of the design shown in FIG. 8, the structural environment being shown in broken lines; and,

FIG. 14 is a rear view of the design shown in FIG. 8.

The broken lines shown in the drawings illustrate structural environment and form no part of the claimed design.

**1 Claim, 14 Drawing Sheets**

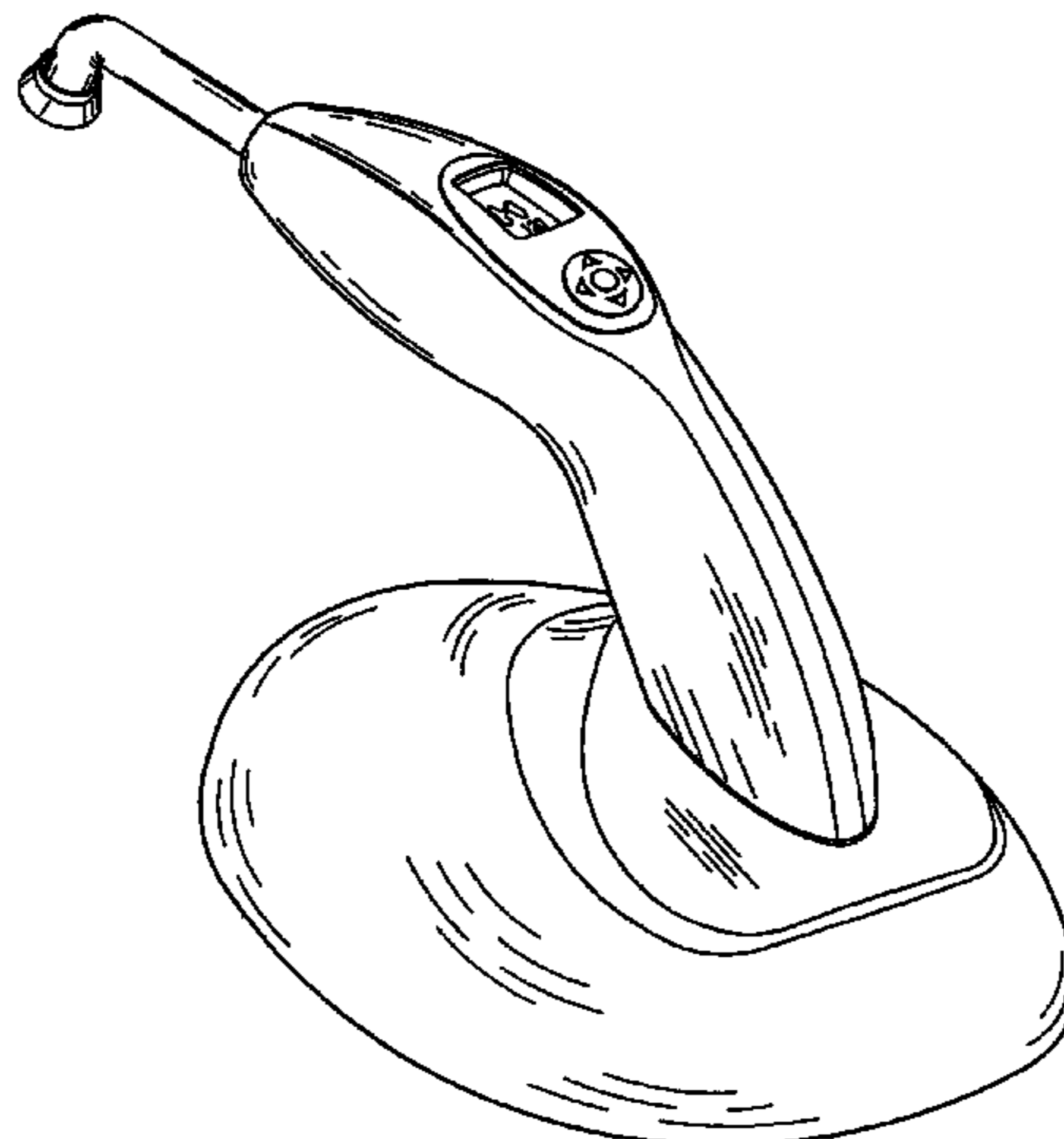

# US D618,799 S

Page 2

---

## U.S. PATENT DOCUMENTS

D340,521 S *	10/1993	Heinzelman et al. ....	D24/176	D521,927 S *	5/2006	Franck et al. ....	D13/108
D342,718 S *	12/1993	Mackay .....	D13/108	D525,583 S *	7/2006	Vu .....	D13/108
D354,566 S *	1/1995	Donahoo .....	D24/152	D532,907 S *	11/2006	Feinbloom et al. ....	D24/152
D494,322 S *	8/2004	Winkler .....	D28/65	D533,276 S *	12/2006	Nakanishi .....	D24/152
D494,679 S *	8/2004	Takahashi .....	D24/158	D580,855 S *	11/2008	Haspil et al. ....	D13/108
D515,214 S *	2/2006	Jackson et al. ....	D24/176	D585,369 S *	1/2009	Castellucci et al. ....	D13/108
D520,446 S *	5/2006	Liu et al. ....	D13/108	D596,561 S *	7/2009	Chon et al. ....	D13/108
				D602,858 S *	10/2009	Ellis et al. ....	D13/108

\* cited by examiner

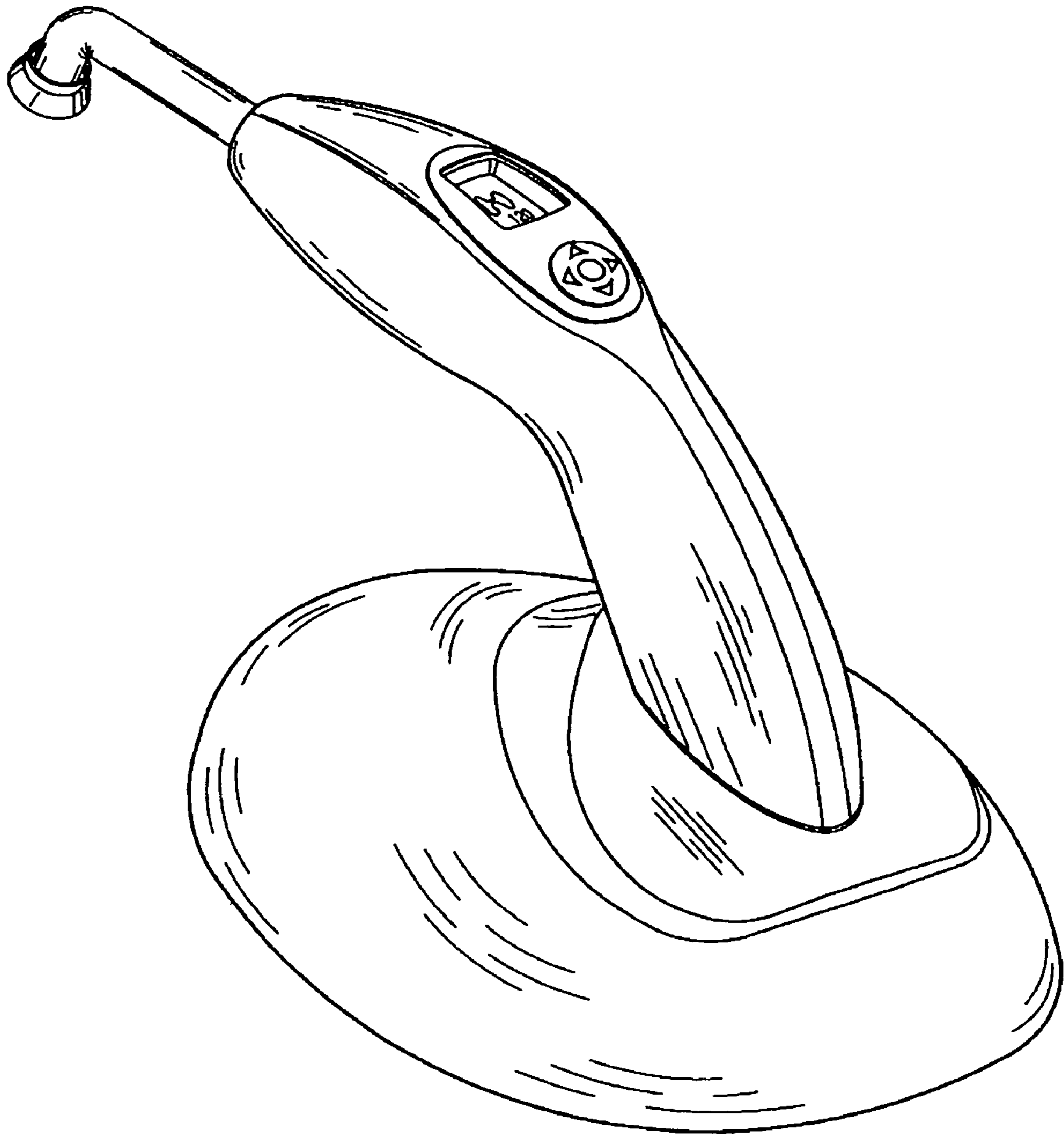

Fig. 1

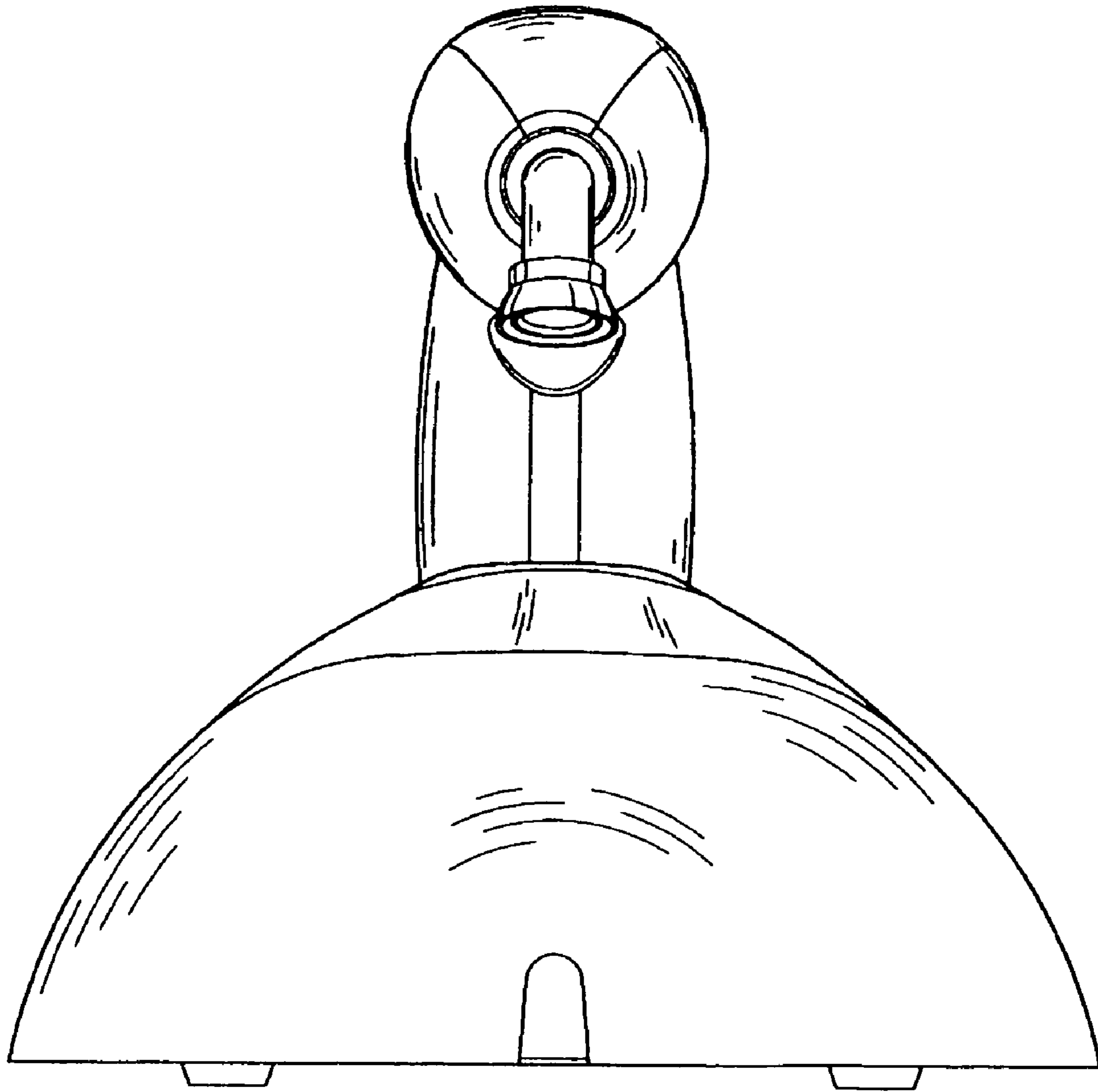

Fig. 2

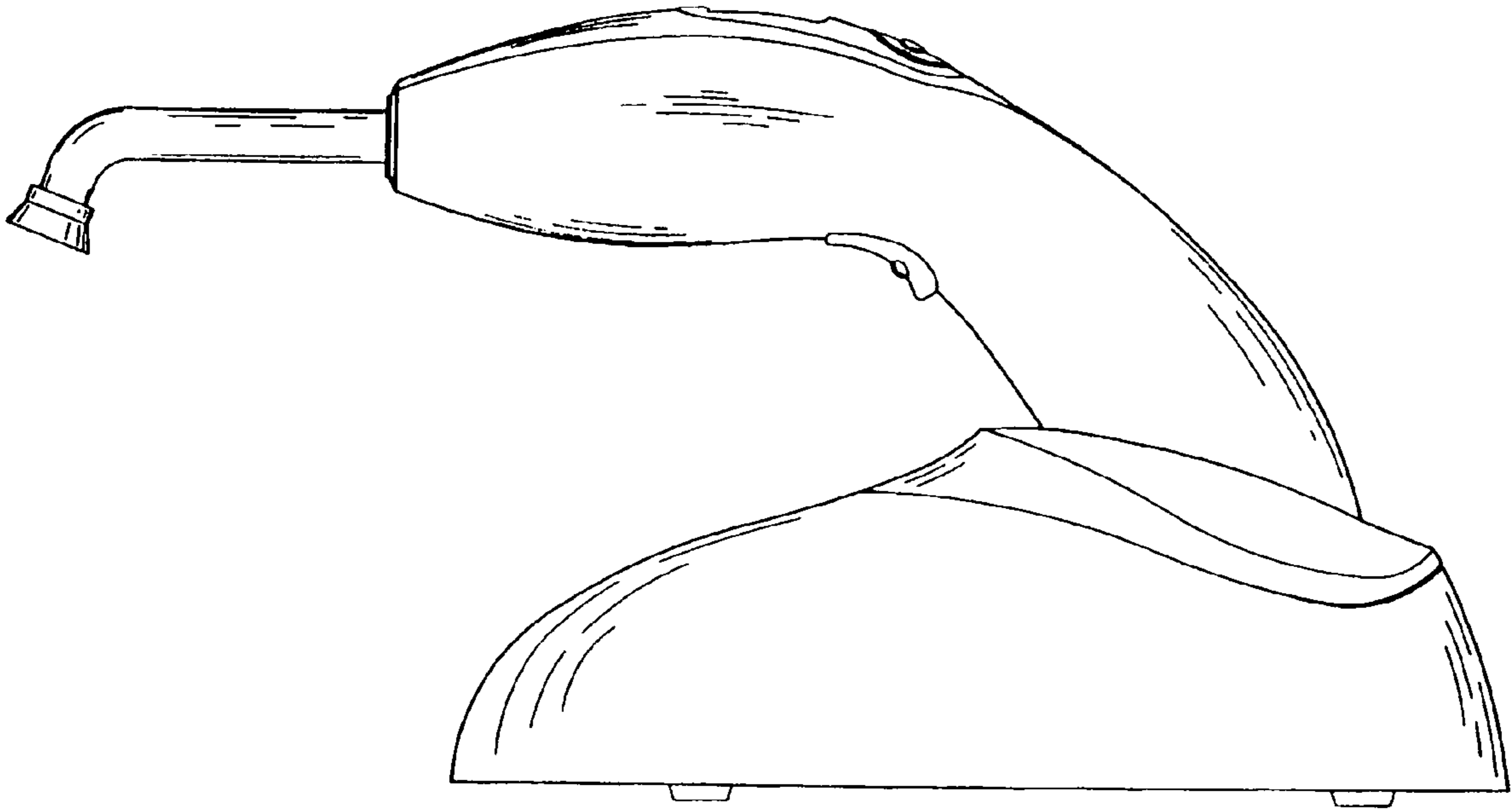

Fig. 3

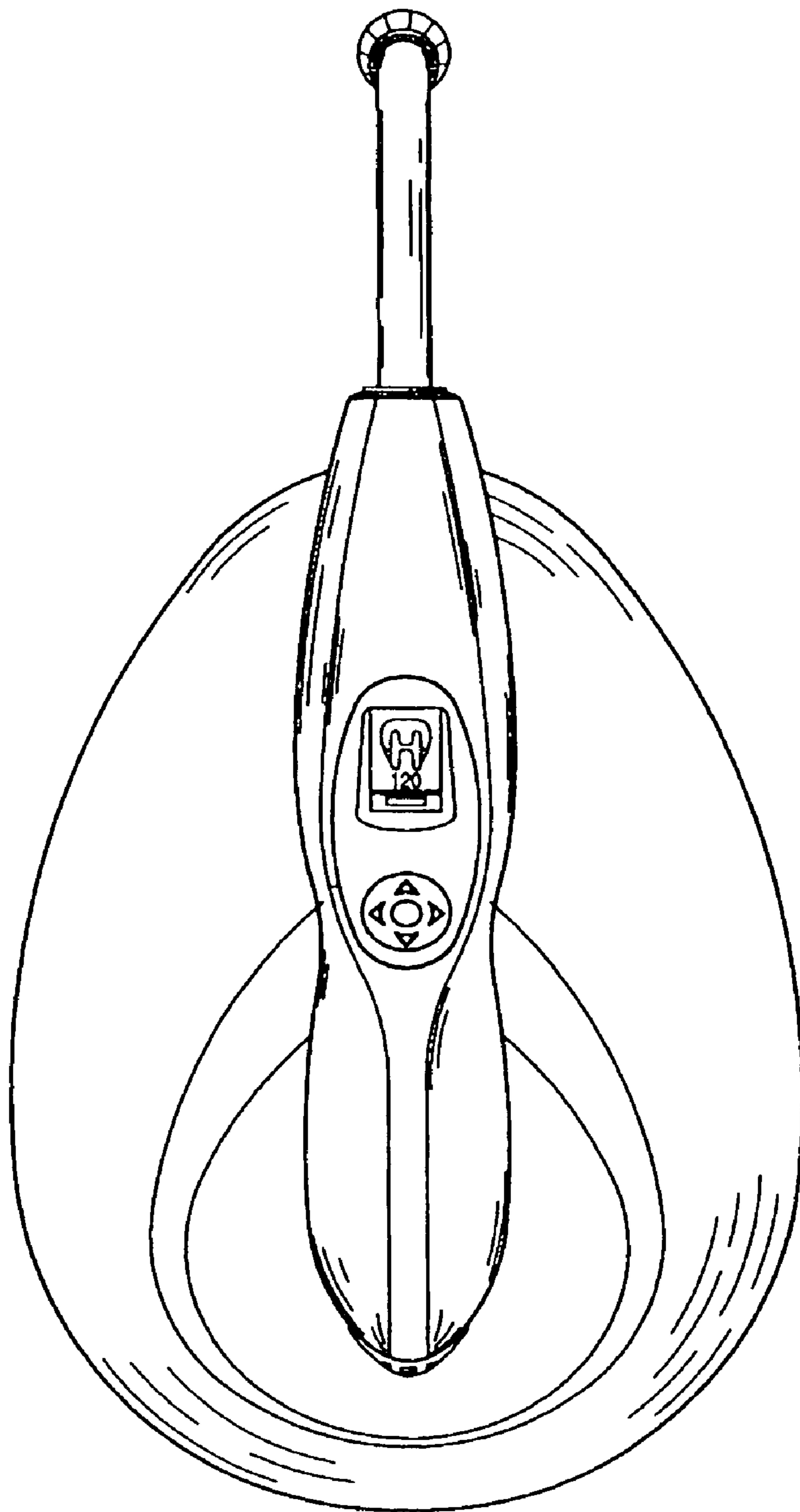

Fig. 4

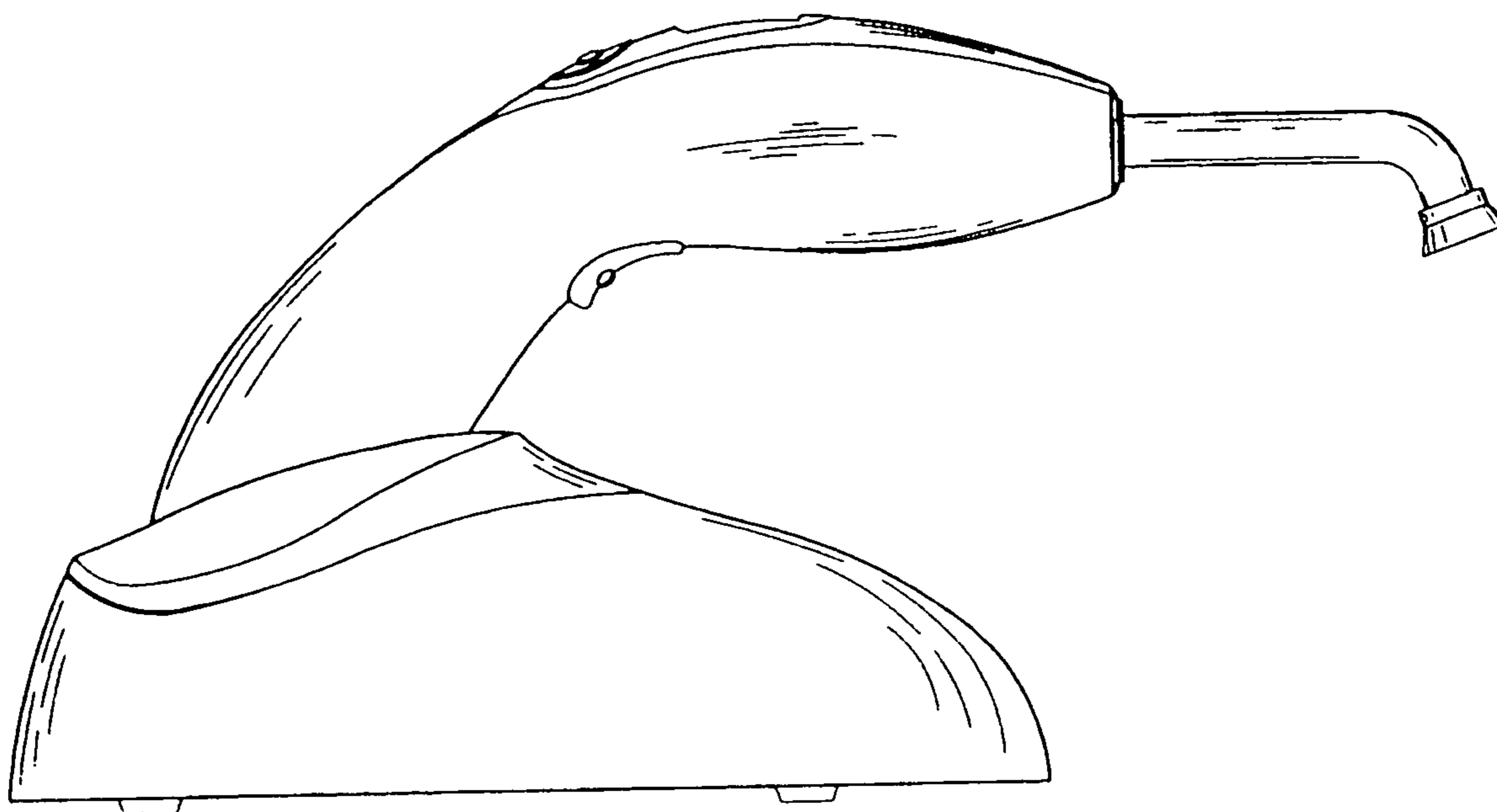

Fig. 5

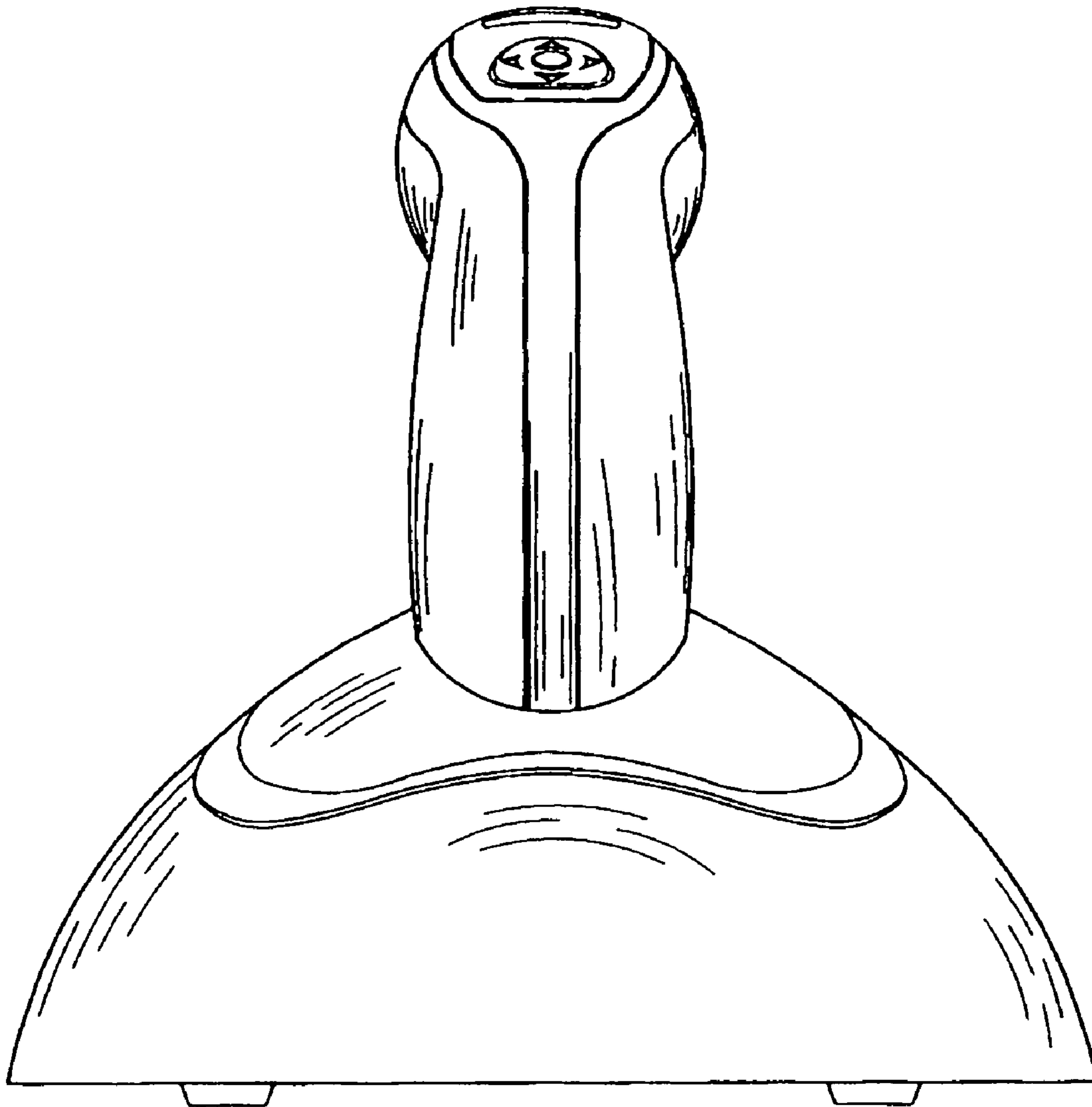

Fig. 6



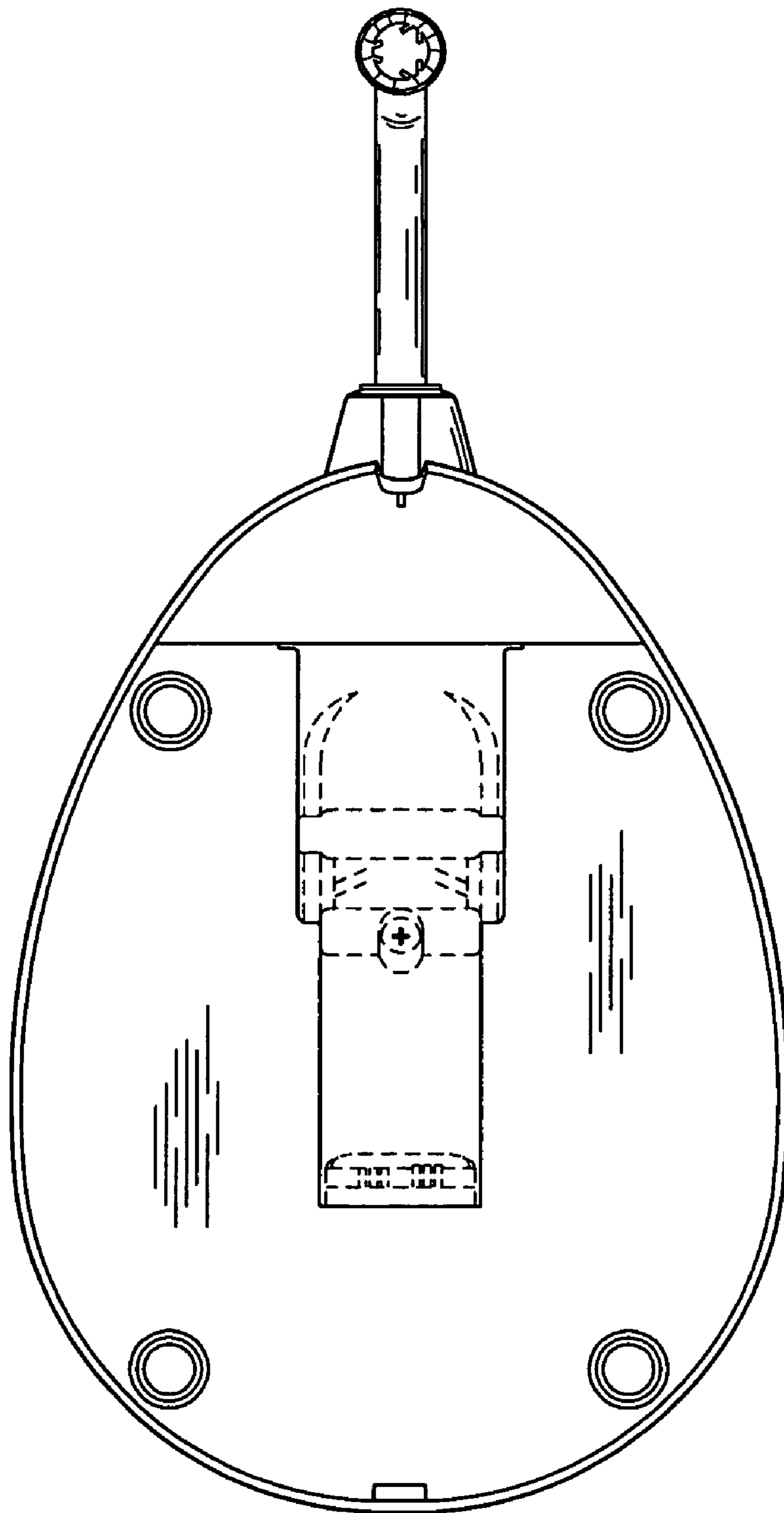

Fig. 7

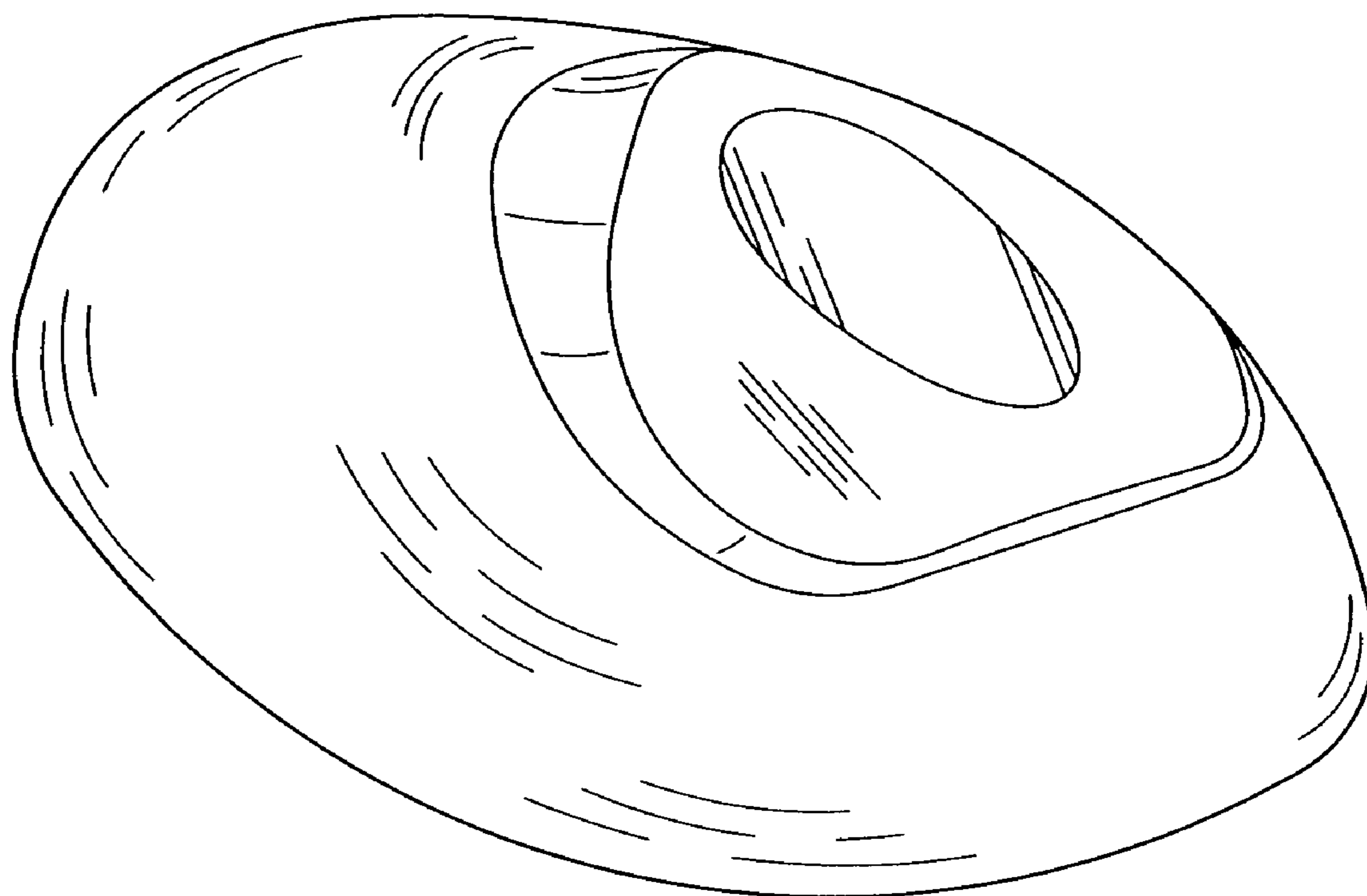

FIG. 8

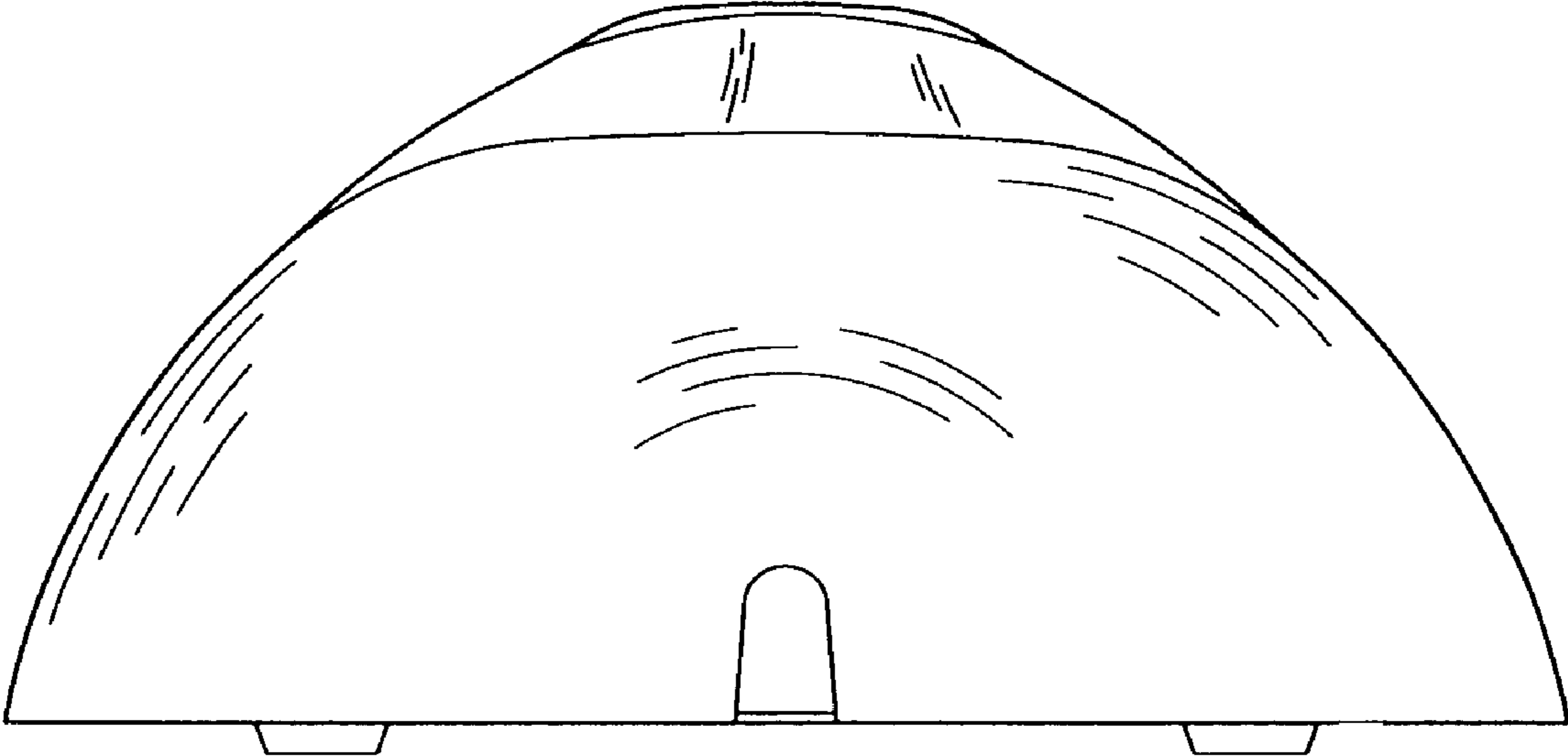

FIG. 9

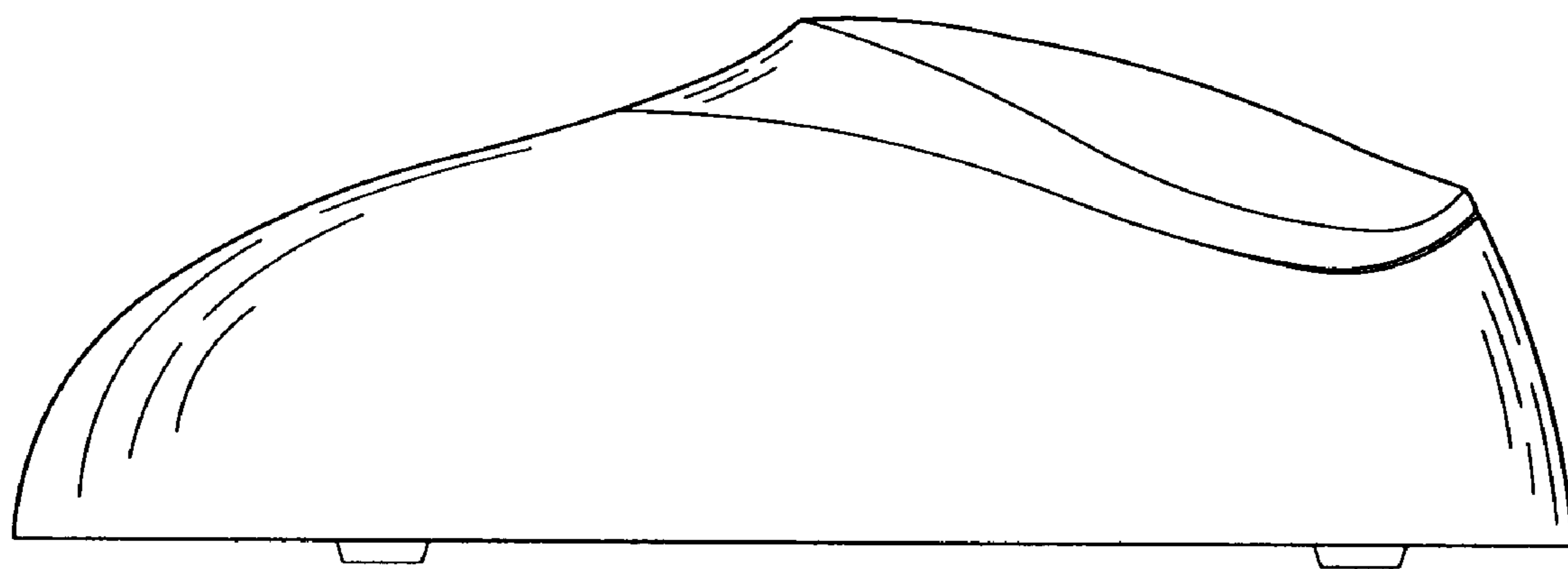

FIG. 10

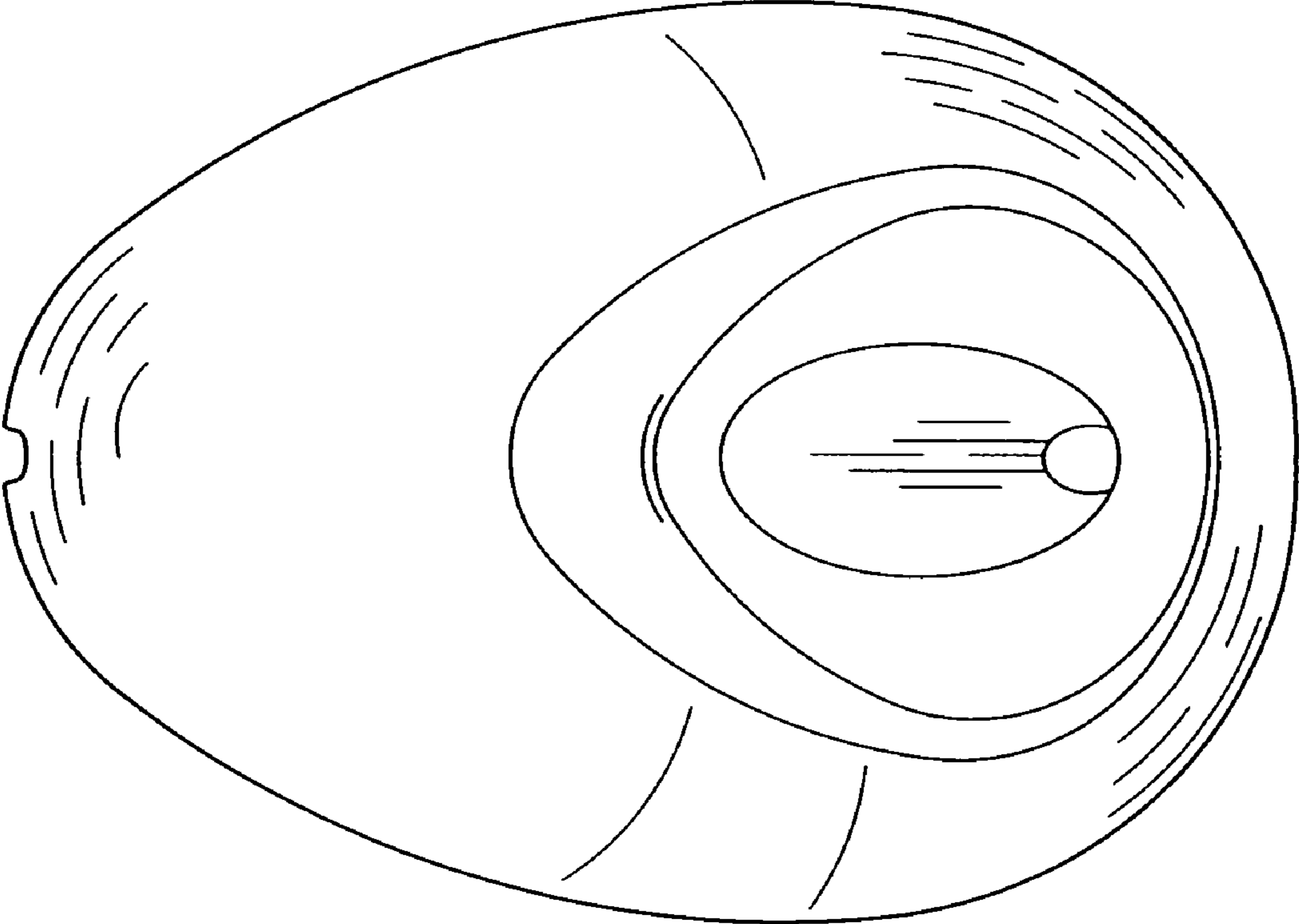

FIG. 11

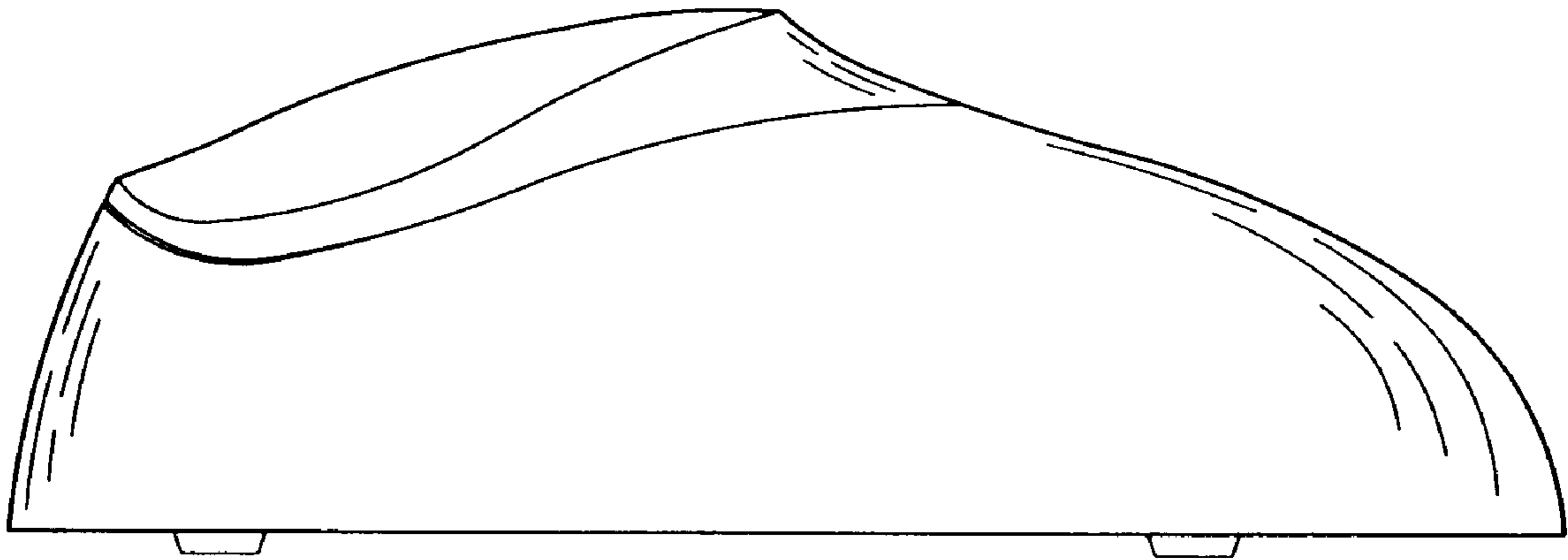

FIG. 12

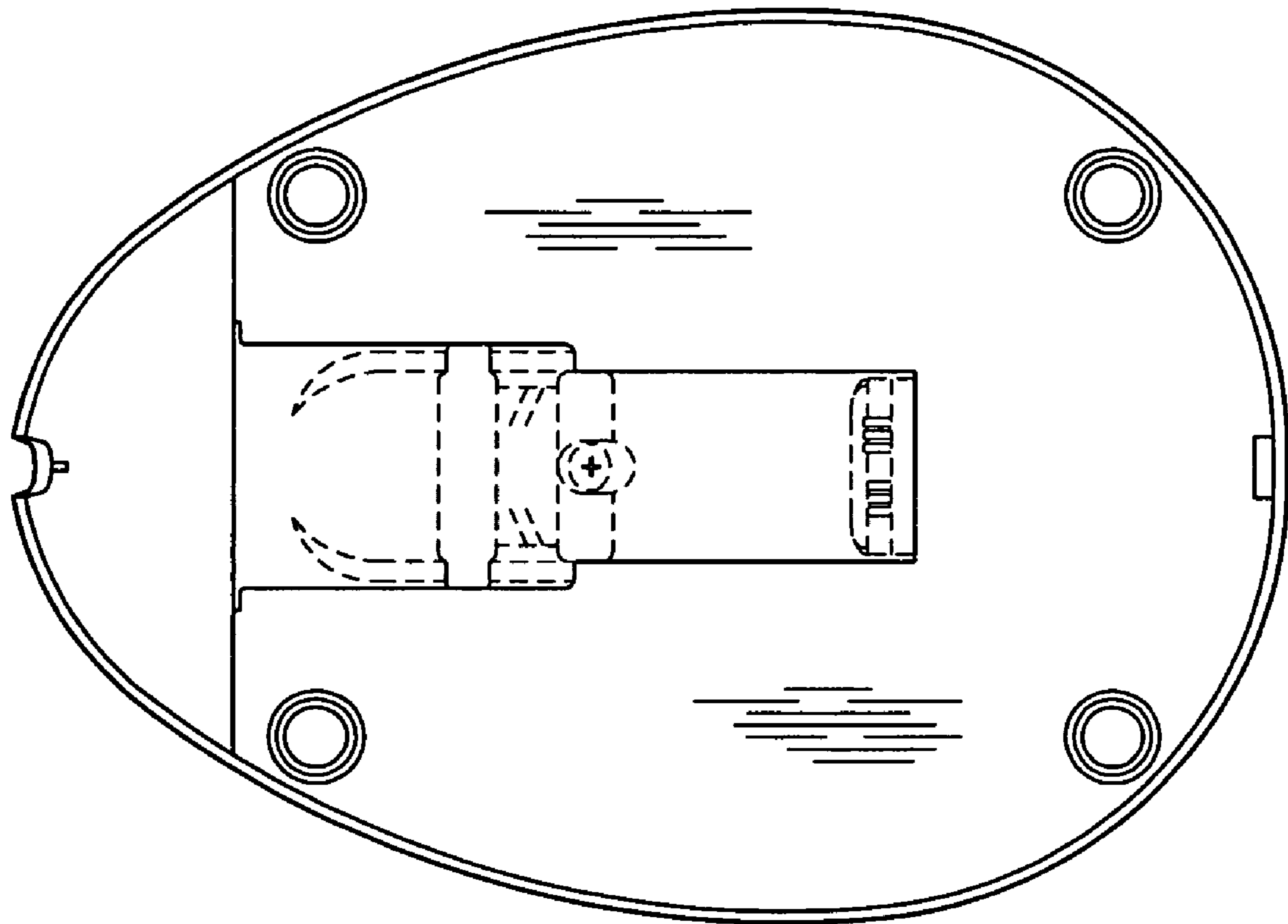

Fig. 13

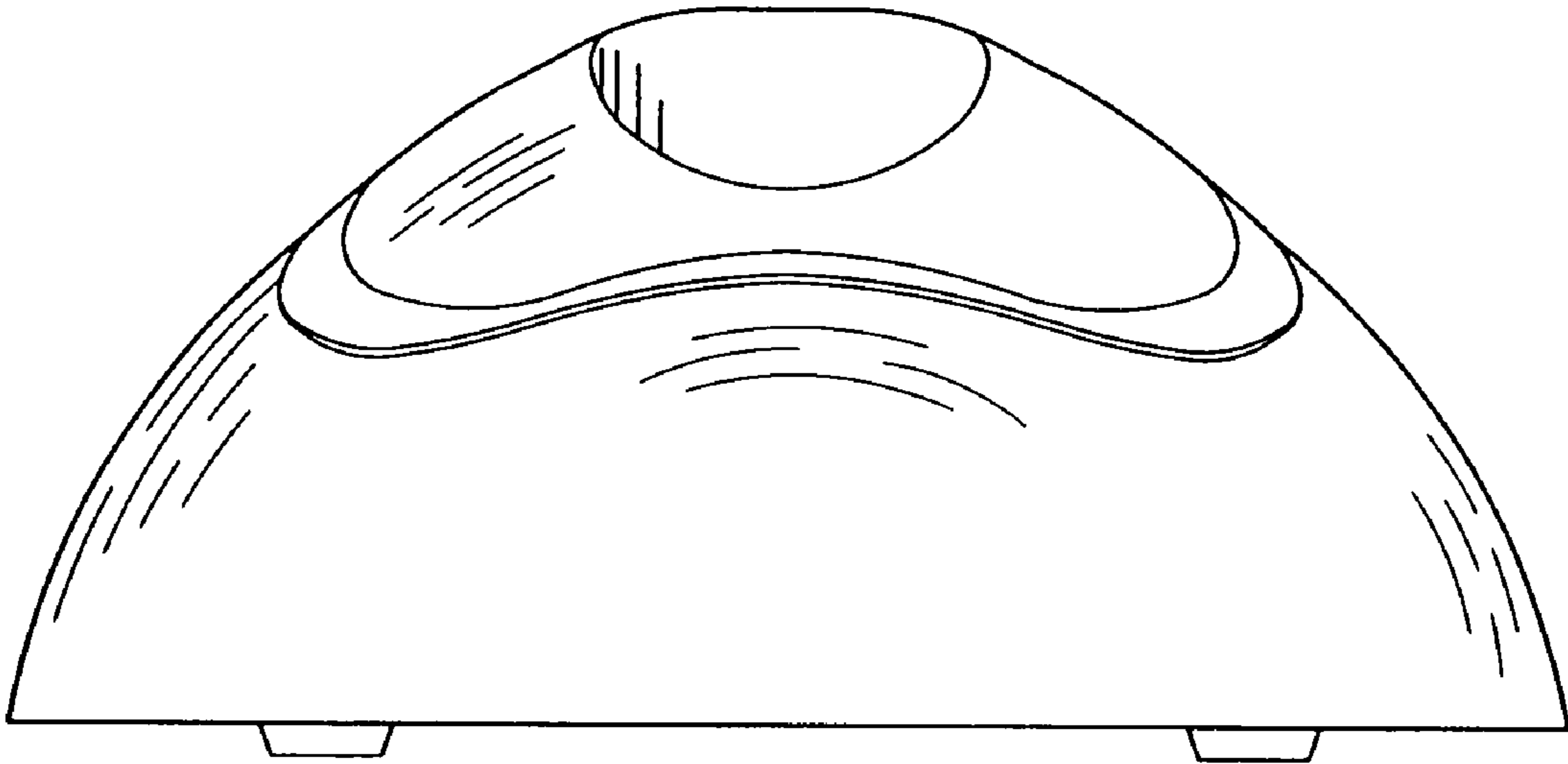

FIG. 14