



US00D618754S

(12) **United States Design Patent**
Schweigert et al.

(10) **Patent No.:** **US D618,754 S**
(45) **Date of Patent:** **** Jun. 29, 2010**

(54) **GOLF CLUB HEAD**

D442,245 S 5/2001 Roach et al.
D445,470 S 7/2001 Teramoto

(75) Inventors: **Bradley D. Schweigert**, Anthem, AZ
(US); **Xiaojian Chen**, Phoenix, AZ
(US); **Michael R. Nicolette**, Scottsdale,
AZ (US); **John A. Solheim**, Phoenix, AZ
(US)

(Continued)

(73) Assignee: **Karsten Manufacturing Corporation**,
Phoenix, AZ (US)

OTHER PUBLICATIONS

Bradley D. Schweigert et al., "Golf Clubs and Methods of Manufac-
ture," U.S. Appl. No. 11/828,158, filed Jul. 25, 2007.

(**) Term: **14 Years**

(Continued)

(21) Appl. No.: **29/357,167**

Primary Examiner—Mitchell I Siegel

(22) Filed: **Mar. 8, 2010**

(57) **CLAIM**

(51) **LOC (9) Cl.** **21-02**

(52) **U.S. Cl.** **D21/759**

(58) **Field of Classification Search** D21/733,
D21/752, 759; 473/324–331, 343–346

The ornamental design for a golf club head, as shown and
described.

See application file for complete search history.

DESCRIPTION

(56) **References Cited**

U.S. PATENT DOCUMENTS

1,993,928 A	3/1935	Glover
D248,179 S	6/1978	Riley
4,139,196 A	2/1979	Riley
5,310,186 A	5/1994	Karsten
5,335,914 A	8/1994	Long
D352,755 S	11/1994	Cornish, III
D357,290 S	4/1995	Viollaz et al.
5,547,188 A	8/1996	Dumontier et al.
D379,391 S	5/1997	Moore
5,658,206 A	8/1997	Antonious
5,795,245 A	8/1998	Chang et al.
D398,682 S	9/1998	Moore
D404,098 S	1/1999	Ishikawa et al.
D418,888 S	1/2000	Williams, Jr.
D425,589 S	5/2000	Ishikawa et al.
D426,604 S	6/2000	Besnard et al.
6,074,310 A	6/2000	Ota
6,080,069 A	6/2000	Long
D441,818 S	5/2001	Sato

FIG. 1 is a top perspective view of a golf club head;
 FIG. 2 is a bottom perspective view of the golf club head of
 FIG. 1;
 FIG. 3 is a front elevational view of the golf club head of FIG.
 1;
 FIG. 4 is a rear elevational view of the golf club head of FIG.
 1;
 FIG. 5 is a top view of the golf club head of FIG. 1;
 FIG. 6 is a bottom view of the golf club head of FIG. 1;
 FIG. 7 is a left side view of the golf club head of FIG. 1; and,
 FIG. 8 is a right side view of the golf club head of FIG. 1.
 The broken lines shown in one or more of the figures are for
 illustrative purposes only and form no part of the claimed
 design.

1 Claim, 4 Drawing Sheets

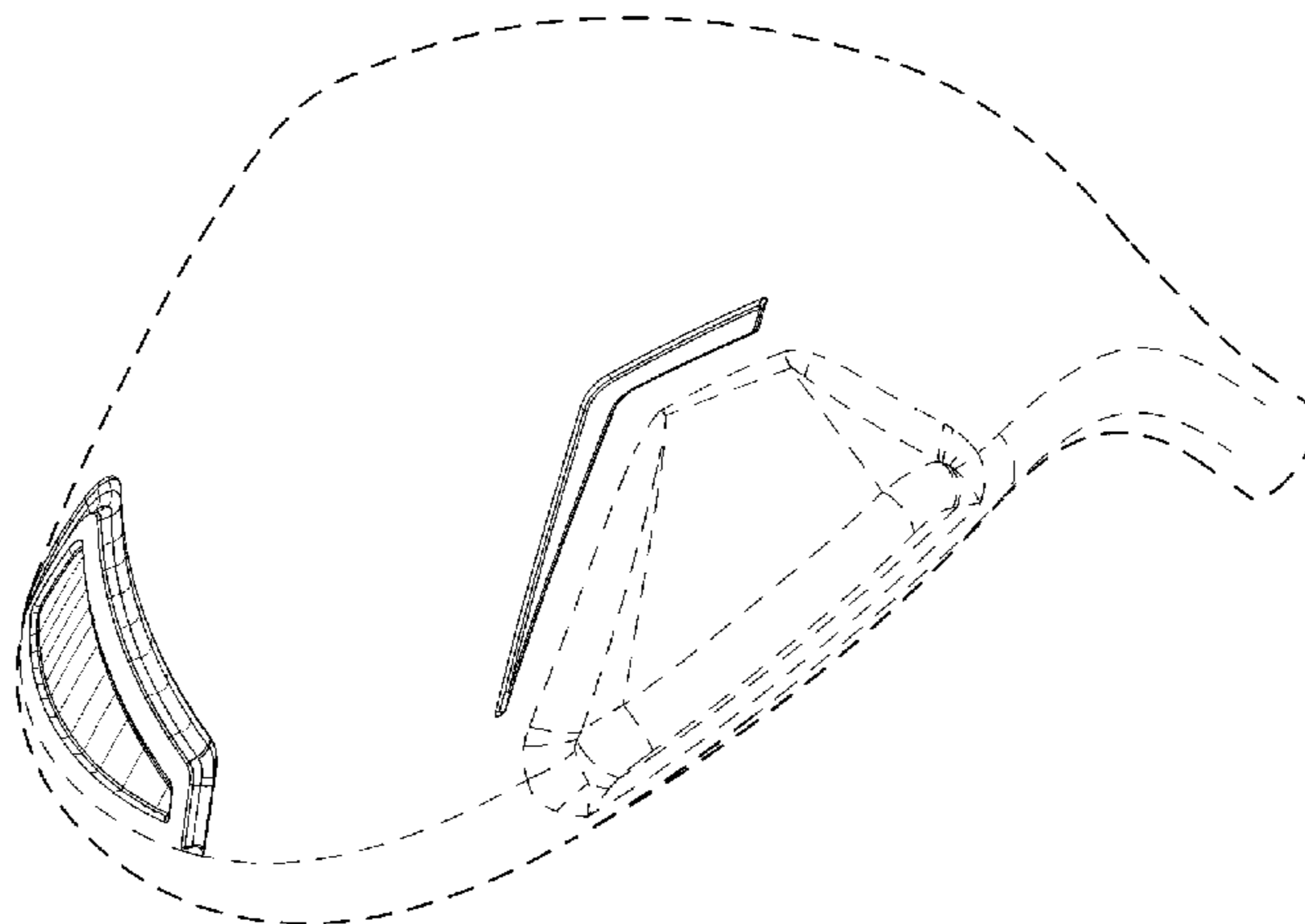

US D618,754 S

Page 2

U.S. PATENT DOCUMENTS

D446,268 S	8/2001	Sato et al.	D566,214 S	4/2008	Evans et al.
D446,563 S	8/2001	Besnard et al.	D567,317 S	4/2008	Jertson et al.
D461,865 S	8/2002	Nagai et al.	D567,891 S	4/2008	Serrano et al.
D463,838 S	10/2002	Besnard et al.	D569,933 S	5/2008	Jertson et al.
6,475,102 B2	11/2002	Helmstetter et al.	D569,934 S	5/2008	Jertson et al.
D472,950 S	4/2003	Burnett et al.	D569,935 S	5/2008	Schweigert et al.
D490,489 S	5/2004	Madore	D569,936 S	5/2008	Schweigert et al.
D492,745 S	7/2004	Tang	D570,937 S	6/2008	Schweigert et al.
D508,544 S	8/2005	Madore	D570,938 S	6/2008	Jertson et al.
D509,272 S	9/2005	Smith et al.	D570,939 S	6/2008	Chen et al.
6,939,247 B1	9/2005	Schweigert et al.	D570,940 S	6/2008	Chen et al.
D513,424 S	1/2006	Erickson et al.	D570,941 S	6/2008	Chen et al.
D514,179 S	1/2006	Chen et al.	D571,882 S	6/2008	Soracco
6,988,960 B2	1/2006	Mahaffey et al.	D572,324 S	7/2008	Chen et al.
D518,129 S	3/2006	Poynor et al.	D572,785 S	7/2008	Chen et al.
D518,543 S	4/2006	Aguinaldo et al.	D572,787 S	7/2008	Sanchez et al.
D521,093 S	5/2006	Jorgensen et al.	D572,791 S	7/2008	Jertson et al.
D522,077 S	5/2006	Schweigert et al.	D573,216 S	7/2008	Sanchez et al.
D522,601 S	6/2006	Schweigert et al.	D573,217 S	7/2008	Sanchez et al.
D523,103 S	6/2006	Hocknell et al.	D573,218 S	7/2008	Sanchez et al.
D523,498 S	6/2006	Chen et al.	D573,676 S	7/2008	Chen et al.
D523,502 S	6/2006	Jorgensen	D574,046 S	7/2008	Chen et al.
D526,694 S	8/2006	Schweigert et al.	D574,048 S	7/2008	Kadoya
D530,761 S	10/2006	Evans et al.	D574,050 S *	7/2008	Jones et al. D21/759
D532,473 S	11/2006	Chen et al.	D574,456 S *	8/2008	Chen et al. D21/759
D532,854 S	11/2006	Oldknow	D578,587 S	10/2008	Hoffman et al.
D535,343 S	1/2007	Chen et al.	D579,066 S	10/2008	Dipert et al.
D536,049 S	1/2007	Evans et al.	D579,067 S	10/2008	Hoffman et al.
D537,139 S	2/2007	Breier et al.	D580,504 S	11/2008	Bosilkovski et al.
D537,495 S	2/2007	Schweigert et al.	D583,432 S	12/2008	Serrano et al.
D537,496 S	2/2007	Serrano et al.	D587,772 S	3/2009	Ferguson et al.
D537,895 S	3/2007	Breier et al.	D588,217 S	3/2009	Jertson et al.
D538,363 S	3/2007	Schweigert et al.	D588,659 S	3/2009	Jertson et al.
D538,367 S	3/2007	Foster et al.	7,503,854 B2	3/2009	Galloway et al.
D538,371 S	3/2007	Kawami	D594,518 S	6/2009	Schweigert
D538,866 S	3/2007	Kim et al.	D594,520 S	6/2009	Schweigert et al.
D538,867 S	3/2007	Cleveland et al.	D594,521 S *	6/2009	Jertson et al. D21/759
D539,371 S	3/2007	Chen et al.	D594,919 S	6/2009	Schweigert et al.
D550,318 S	9/2007	Oldknow	D596,252 S *	7/2009	Jertson et al. D21/752
D550,799 S	9/2007	Lin	D600,297 S *	9/2009	Jertson et al. D21/752
D552,198 S	10/2007	Schweigert et al.	D603,472 S	11/2009	Schweigert et al.
D553,206 S	10/2007	Morales et al.	D606,144 S *	12/2009	Kim et al. D21/752
D555,745 S	11/2007	Rollinson et al.	2005/0043117 A1	2/2005	Gilbert et al.
D557,362 S	12/2007	Serrano et al.	2008/0039228 A1	2/2008	Breier et al.
D557,363 S	12/2007	Jertson et al.	2008/0153625 A1	6/2008	Morales et al.
D558,287 S	12/2007	Jertson et al.	2008/0171612 A1	7/2008	Serrano et al.
D558,288 S	12/2007	Jertson et al.	2009/0275419 A1	11/2009	Cackett et al.
D561,286 S	2/2008	Morales et al.			
D562,421 S	2/2008	Jertson et al.			
7,326,472 B2	2/2008	Shimazaki et al.			
D563,498 S	3/2008	Jertson et al.			
D564,054 S	3/2008	Jertson et al.			
D564,055 S	3/2008	Jertson et al.			
D564,056 S	3/2008	Chen et al.			

OTHER PUBLICATIONS

Marty R. Jertson et al., "Golf Club Head," U.S. Appl. No. 29/342,399, filed Aug. 24, 2009.

Bradley D. Schweigert et al., "Golf Club Head," U.S. Appl. No. 29/357,169, filed Mar. 8, 2010.

* cited by examiner

Fig. 1

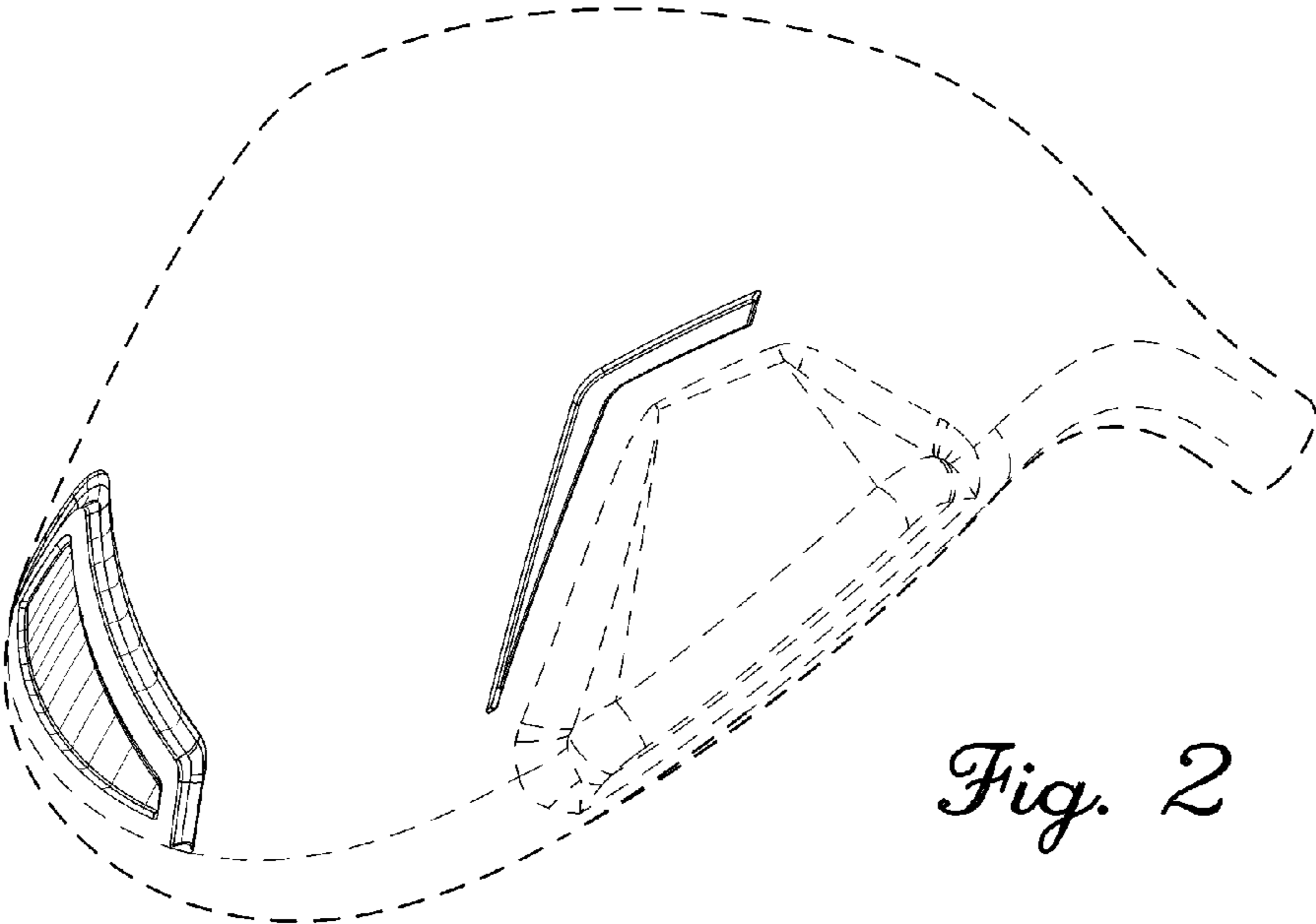
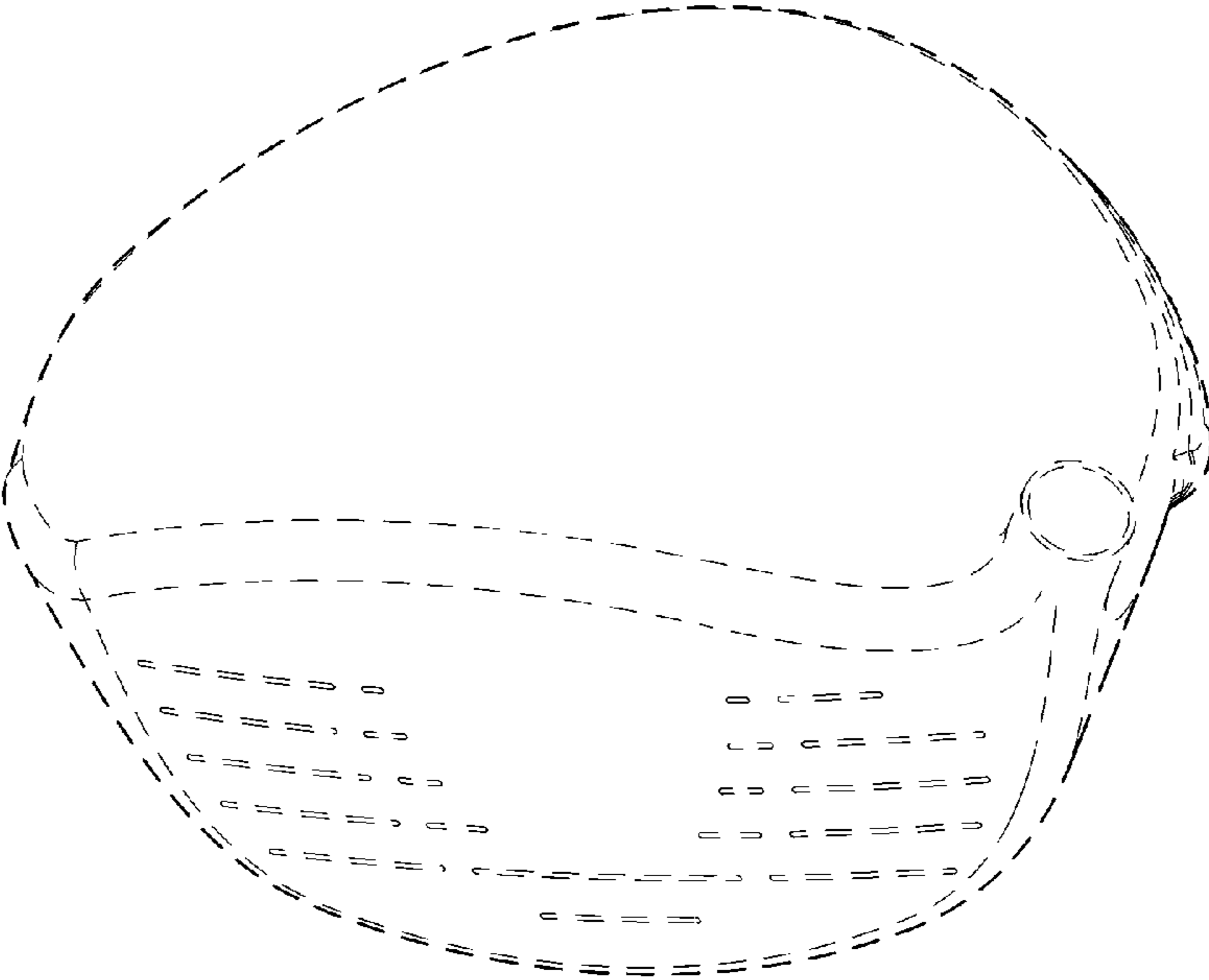

Fig. 2

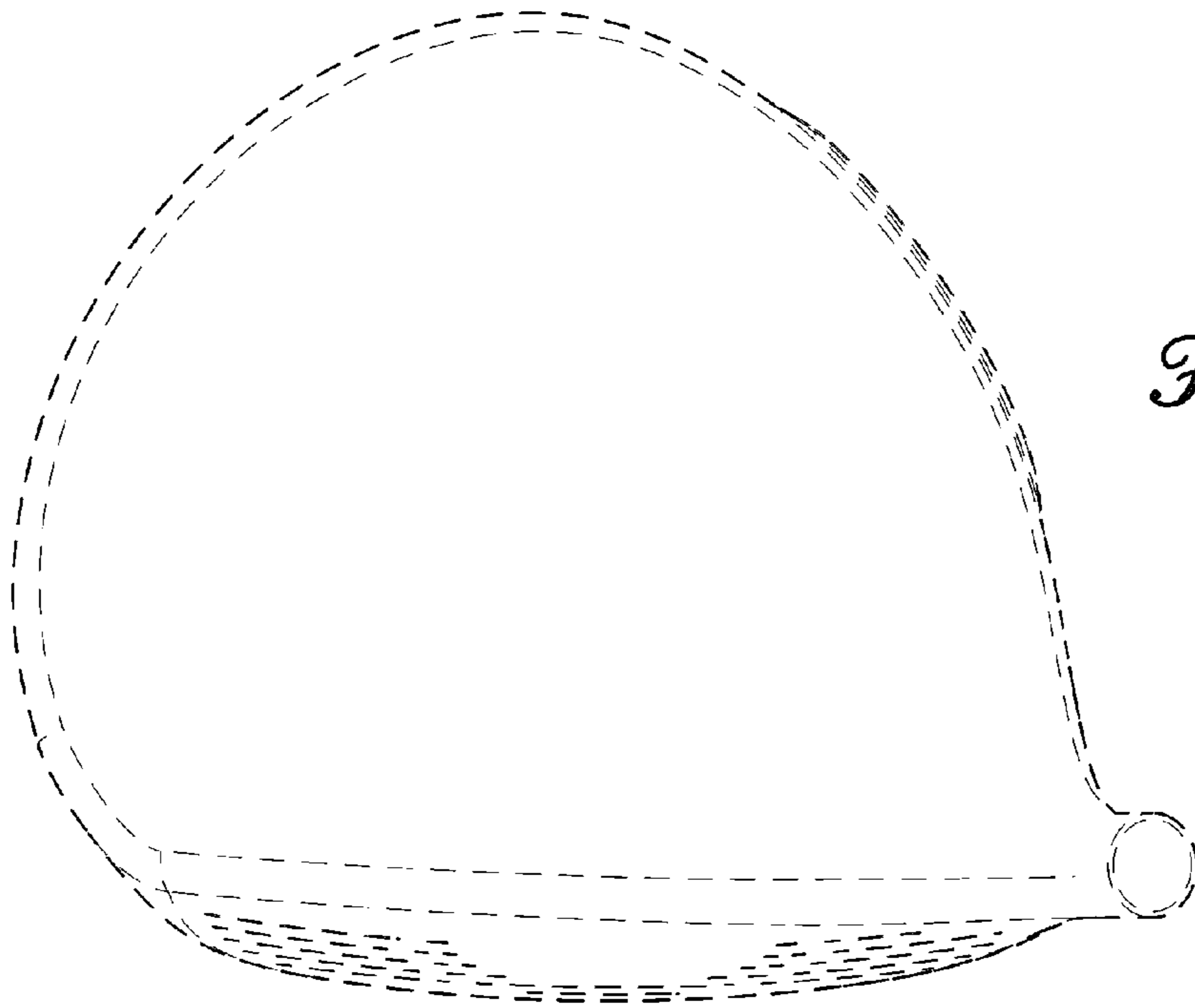

Fig. 3

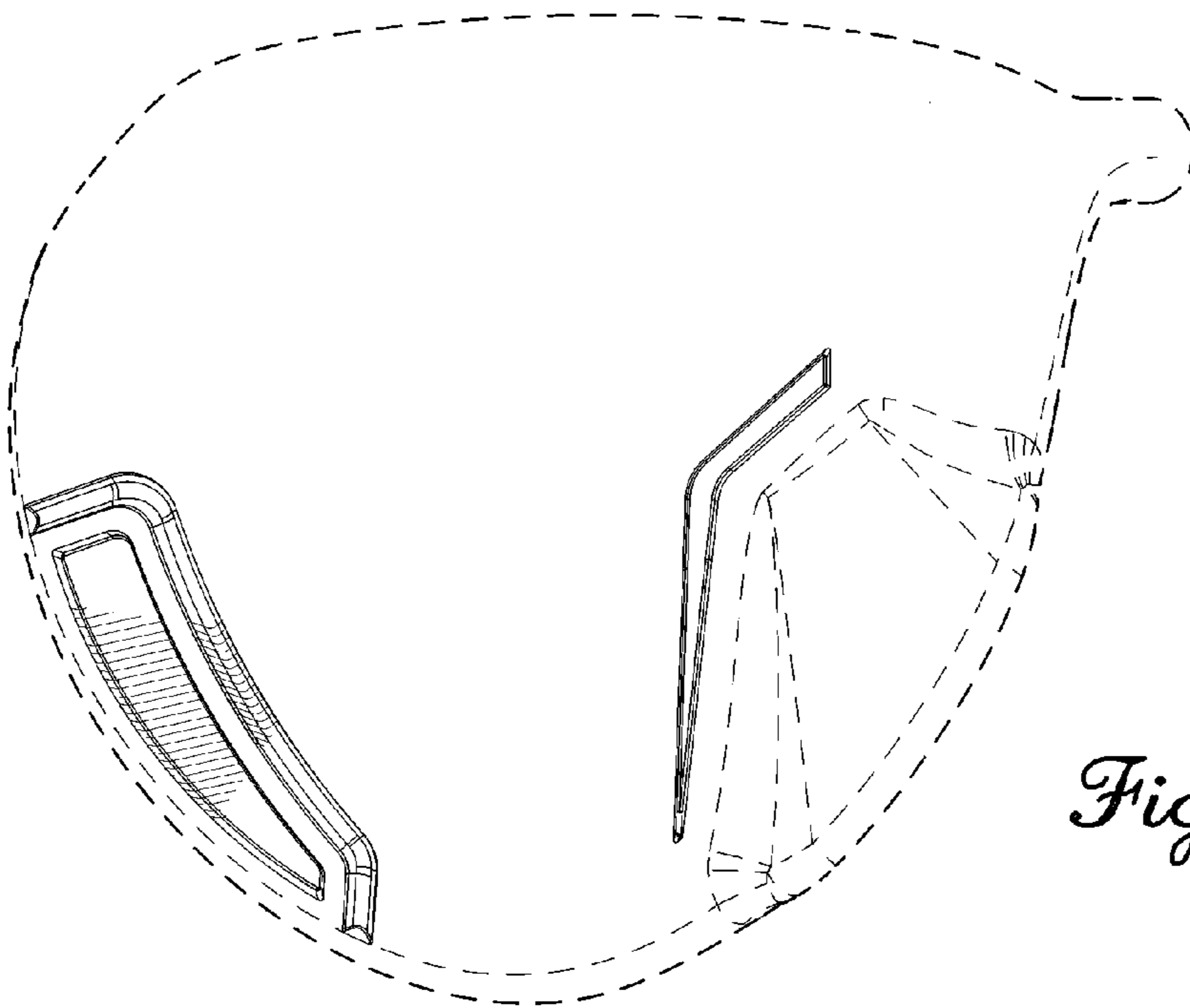

Fig. 4

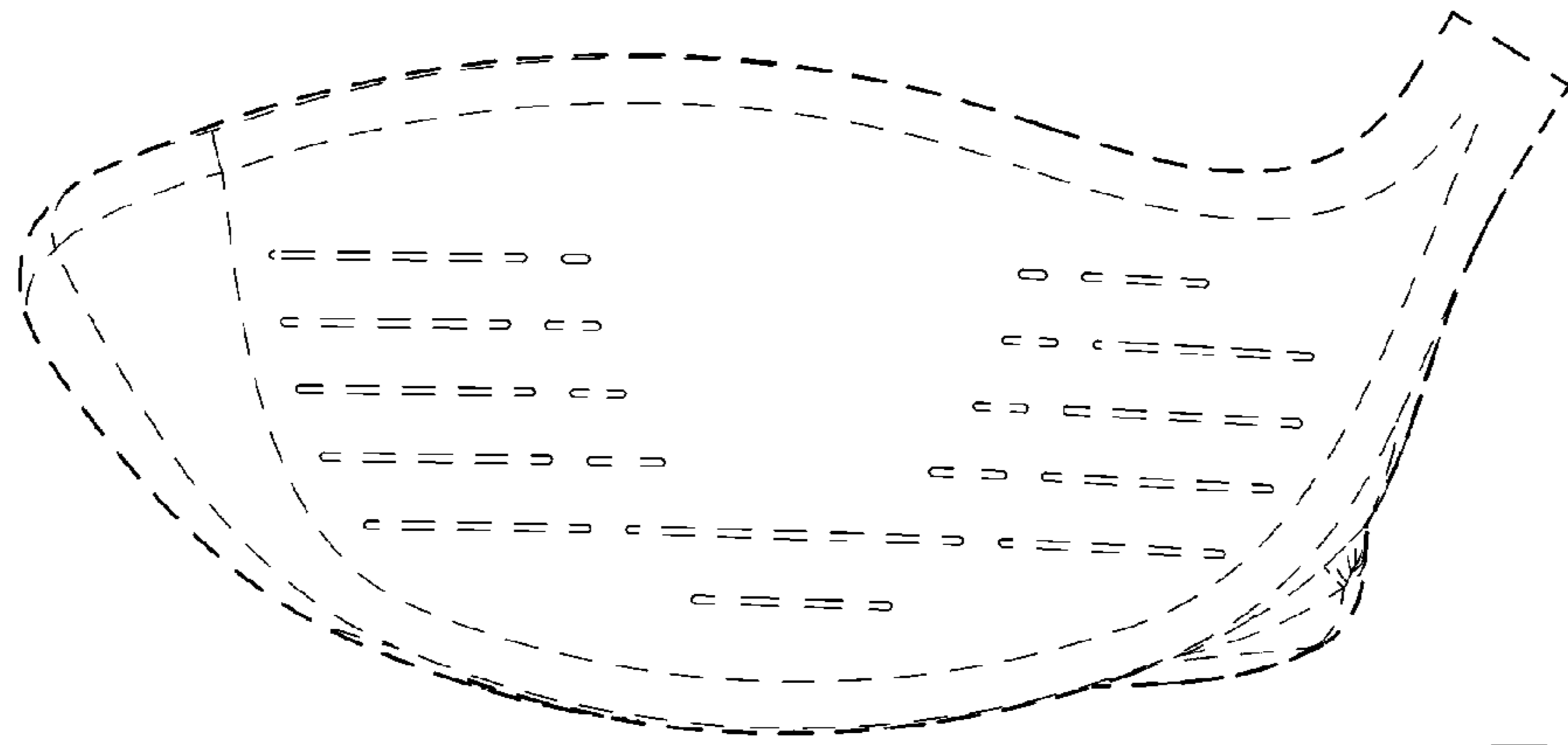

Fig. 5

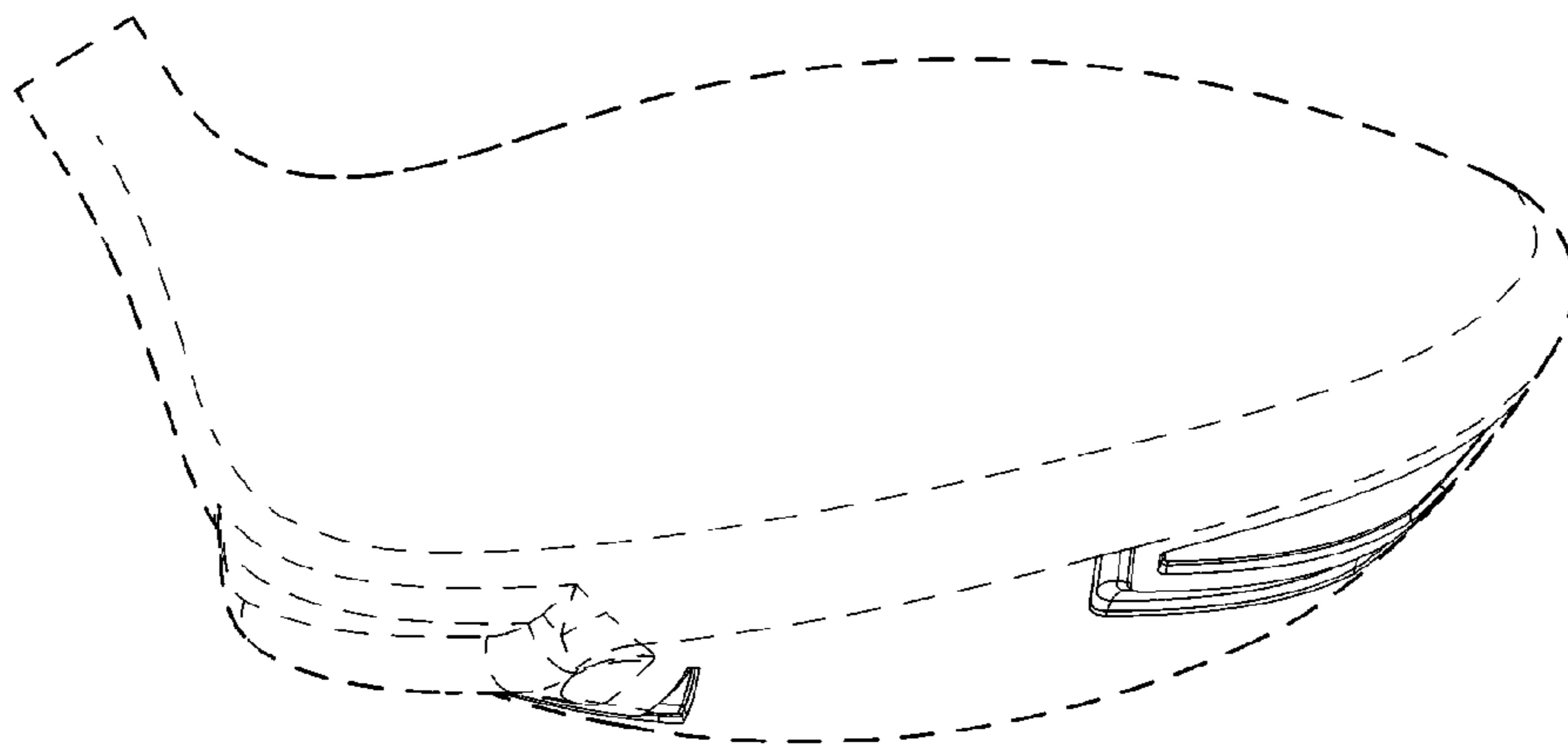

Fig. 6

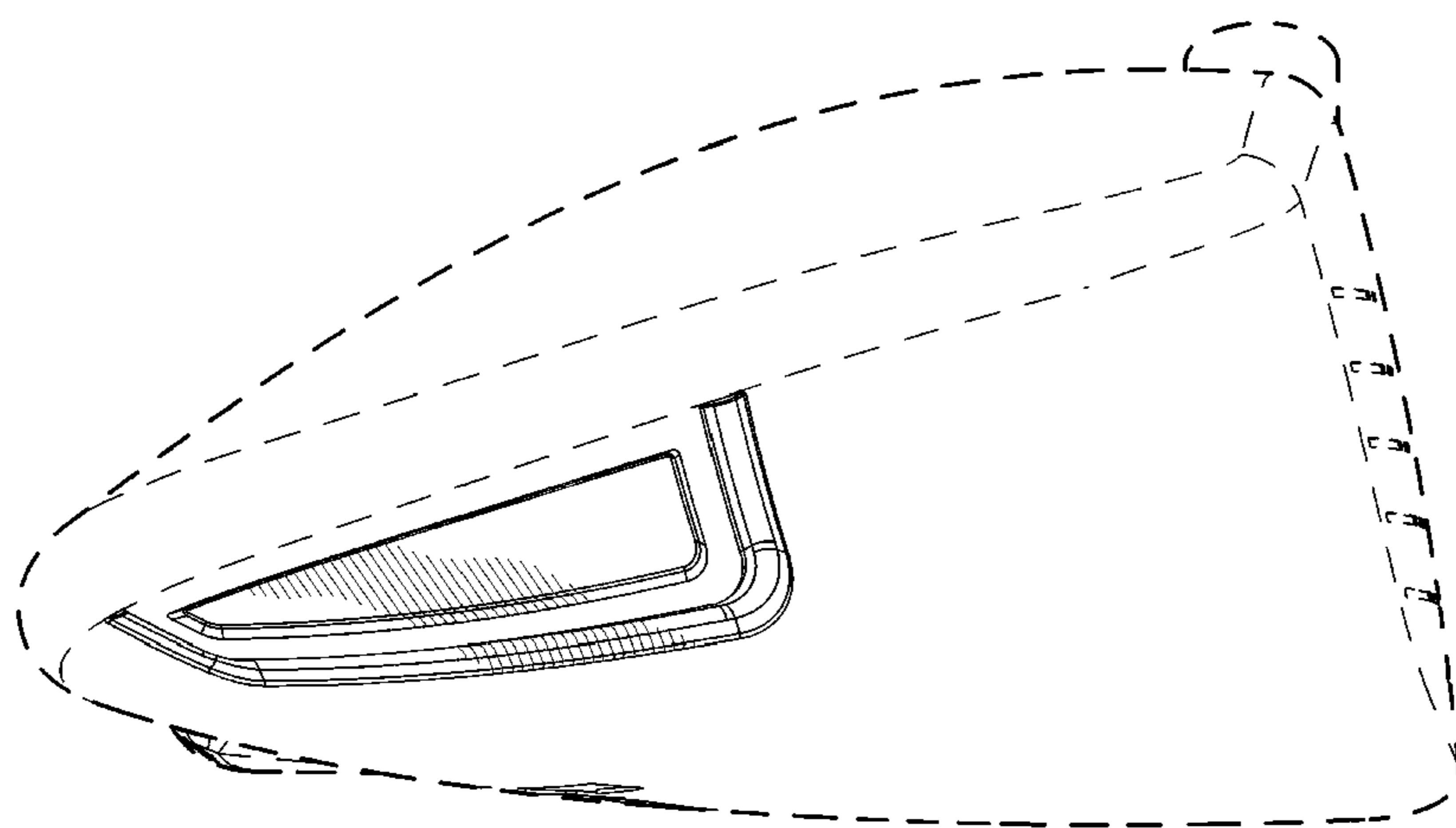

Fig. 7

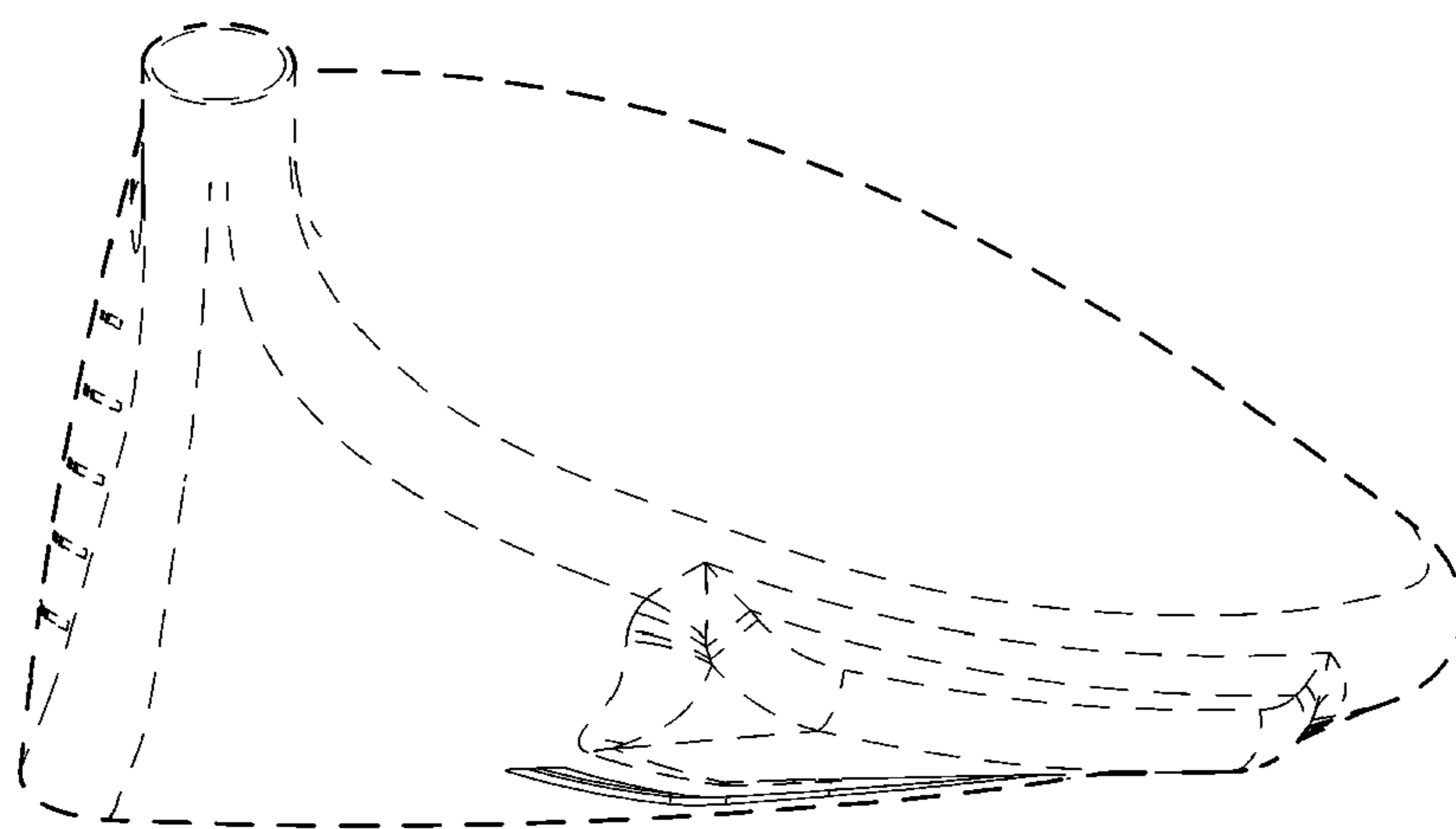

Fig. 8

UNITED STATES PATENT AND TRADEMARK OFFICE
CERTIFICATE OF CORRECTION

PATENT NO. : D618,754 S
APPLICATION NO. : 29/357167
DATED : June 29, 2010
INVENTOR(S) : Bradley D. Schweigert et al.

Page 1 of 1

It is certified that error appears in the above-identified patent and that said Letters Patent is hereby corrected as shown below:

Title Page

In the DESCRIPTION:

After "FIG. 3 is a", delete "front elevational" and insert --top--;

After "FIG. 4 is a", delete "rear elevational" and insert --bottom--;

After "FIG. 5 is a", delete "top" and insert --front elevational--;

After "FIG. 6 is a", delete "bottom" and insert --rear elevational--;

Signed and Sealed this
First Day of March, 2011

A handwritten signature in black ink, reading "David J. Kappos". The signature is written in a cursive style with a large initial "D".

David J. Kappos
Director of the United States Patent and Trademark Office