



US00D618673S

(12) **United States Design Patent**
Mota Veiga et al.

(10) **Patent No.:** **US D618,673 S**
(45) **Date of Patent:** **** Jun. 29, 2010**

(54) **MOBILE DEVICE HOUSING**

D572,693 S * 7/2008 Miake D14/138 AA

(75) Inventors: **Daniel Mota Veiga**, San Clemente, CA
(US); **Michael A. Gailloux**, Overland
Park, KS (US)

(Continued)

(73) Assignee: **Sprint Communications Company**
L.P., Overland Park, KS (US)

FOREIGN PATENT DOCUMENTS

WO DM/071244 * 9/2008

(**) Term: **14 Years**

(21) Appl. No.: **29/321,979**

OTHER PUBLICATIONS

(22) Filed: **Jul. 28, 2008**

Samsung ACE, <URL:http://nextelonline.nextel.com/NASApp/
onlinestore/en/Action/DisplayPhones?audience=INDIVIDUAL
&language=EN&id12=UHP_PhonesTab_link_AllPhones>,
retrieved from interent Jan. 31, 2010.*

(51) **LOC (9) Cl.** **14-03**

(52) **U.S. Cl.** **D14/248**

(58) **Field of Classification Search** D14/138 AA,
D14/138 AB, 138 AC, 138 AD, 138 C, 138 G,
D14/138 R, 147-148, 156, 218, 247-248,
D14/341-347, 390, 399, 455-456, 496, 172,
D14/188, 191, 192, 194, 167; D21/329,
D21/331, 333, 517; 348/14.01-14.02; 361/814;
379/433.01-433.13; 455/90.3, 556.1-556.2,
455/566, 575.1, 575.3, 575.4; D13/164,
D13/168; 345/167, 168, 169
See application file for complete search history.

(Continued)

Primary Examiner—Robert M Spear
Assistant Examiner—Carla Jobe Wright

(57) **CLAIM**

The ornamental design for a mobile device housing, as shown
and described.

(56) **References Cited**

DESCRIPTION

U.S. PATENT DOCUMENTS

- D395,301 S * 6/1998 Harris et al. D14/138 AA
- D408,811 S * 4/1999 Page et al. D14/137
- D434,410 S * 11/2000 Frye et al. D14/248
- D470,117 S * 2/2003 Langford D14/138 AA
- D487,069 S * 2/2004 Thaler et al. D14/138 AA
- D546,314 S * 7/2007 Im D14/138 AA
- D548,217 S * 8/2007 Choi et al. D14/138 AA
- D551,653 S * 9/2007 Nohara D14/167
- D552,582 S * 10/2007 Moon et al. D14/138 AA
- D556,176 S * 11/2007 Kim et al. D14/138 AA
- D561,199 S * 2/2008 Morisawa D14/496
- D562,283 S * 2/2008 Moon et al. D14/138 AA
- D562,297 S * 2/2008 Kim et al. D14/138 AA
- D565,528 S * 4/2008 Swallow D14/137
- D572,268 S * 7/2008 Niizawa et al. D14/496

FIG. 1 is a perspective view of a mobile device housing
illustrating our new design;
FIG. 2 is a front elevation view of the mobile device housing;
FIG. 3 is a bottom plan view of the mobile device housing;
FIG. 4 is a rear elevation view of the mobile device housing;
FIG. 5 is a top plan view of the mobile device housing; and,
FIG. 6 is a side elevation view of the mobile device housing.
The broken lines in the drawings of the mobile device housing
are for illustrative purposes only and form no part of the
claimed design.

1 Claim, 2 Drawing Sheets

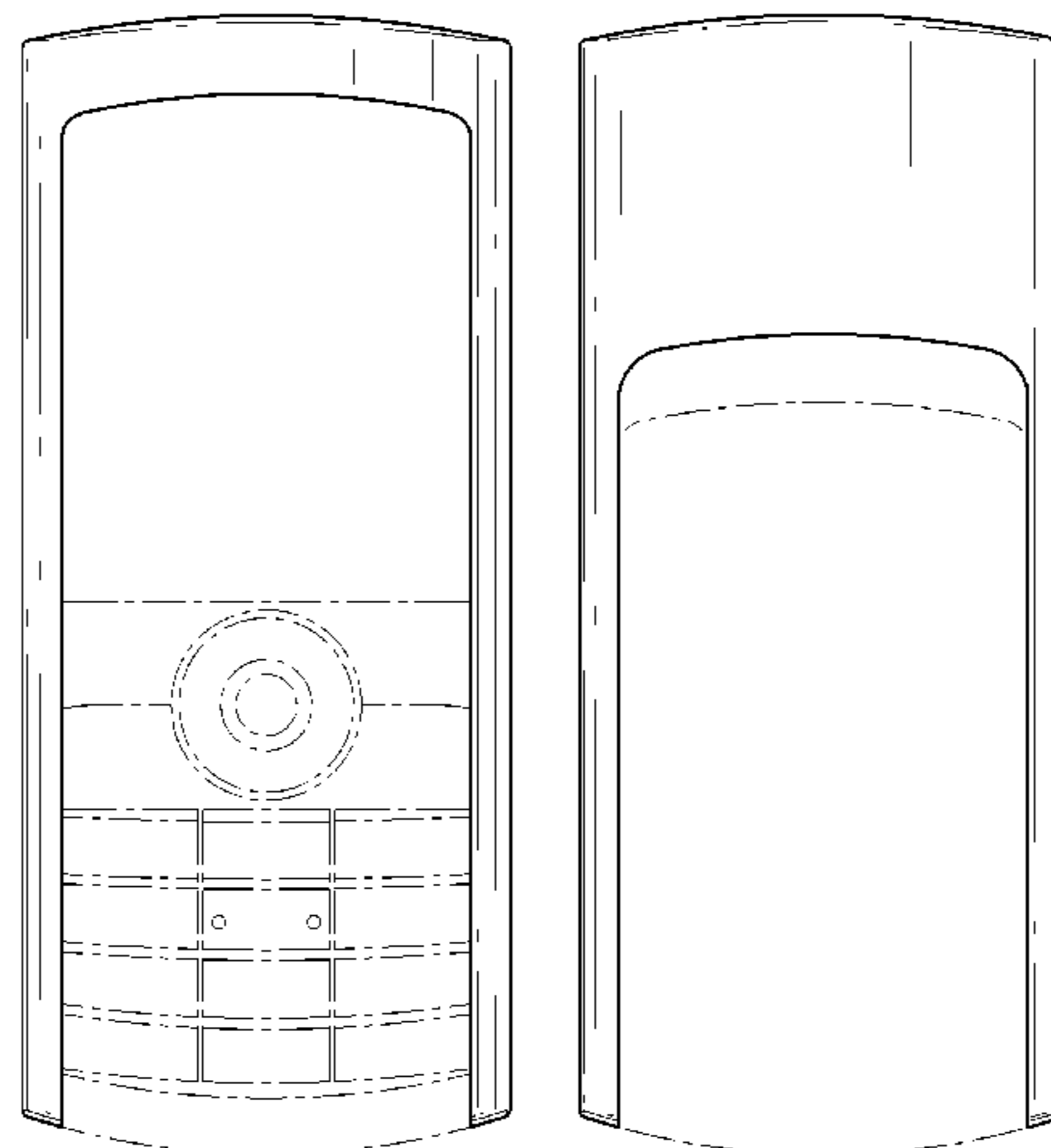

US D618,673 S

Page 2

U.S. PATENT DOCUMENTS

D573,972 S * 7/2008 Lee et al. D14/138 AA
D576,994 S * 9/2008 Oh et al. D14/138 AA
D584,262 S * 1/2009 Hu et al. D14/138 AA
D584,271 S * 1/2009 Ko et al. D14/138 AA
D585,367 S * 1/2009 Dunbar et al. D13/108
D593,050 S * 5/2009 Kim et al. D14/138 R
D597,050 S * 7/2009 Kim et al. D14/138 AA
D599,764 S * 9/2009 Park D14/138 AA
D606,994 S * 12/2009 Griffin et al. D14/346

2009/0209305 A1* 8/2009 Lee et al. 455/575.4

OTHER PUBLICATIONS

Nokia X6 16GB, announced Jan. 1020, <URL:http://www.gsmarena.com/nokia_x6_16gb-3109.php>, retrieved from internet Jan. 31, 2010.*

Sony Ericsson W902, announced Jul. 2008, <URL:http://www.gsmarena.com/sony_ericsson_w902-2468.php>, retrieved from Internet Jan. 31, 2010.*

* cited by examiner

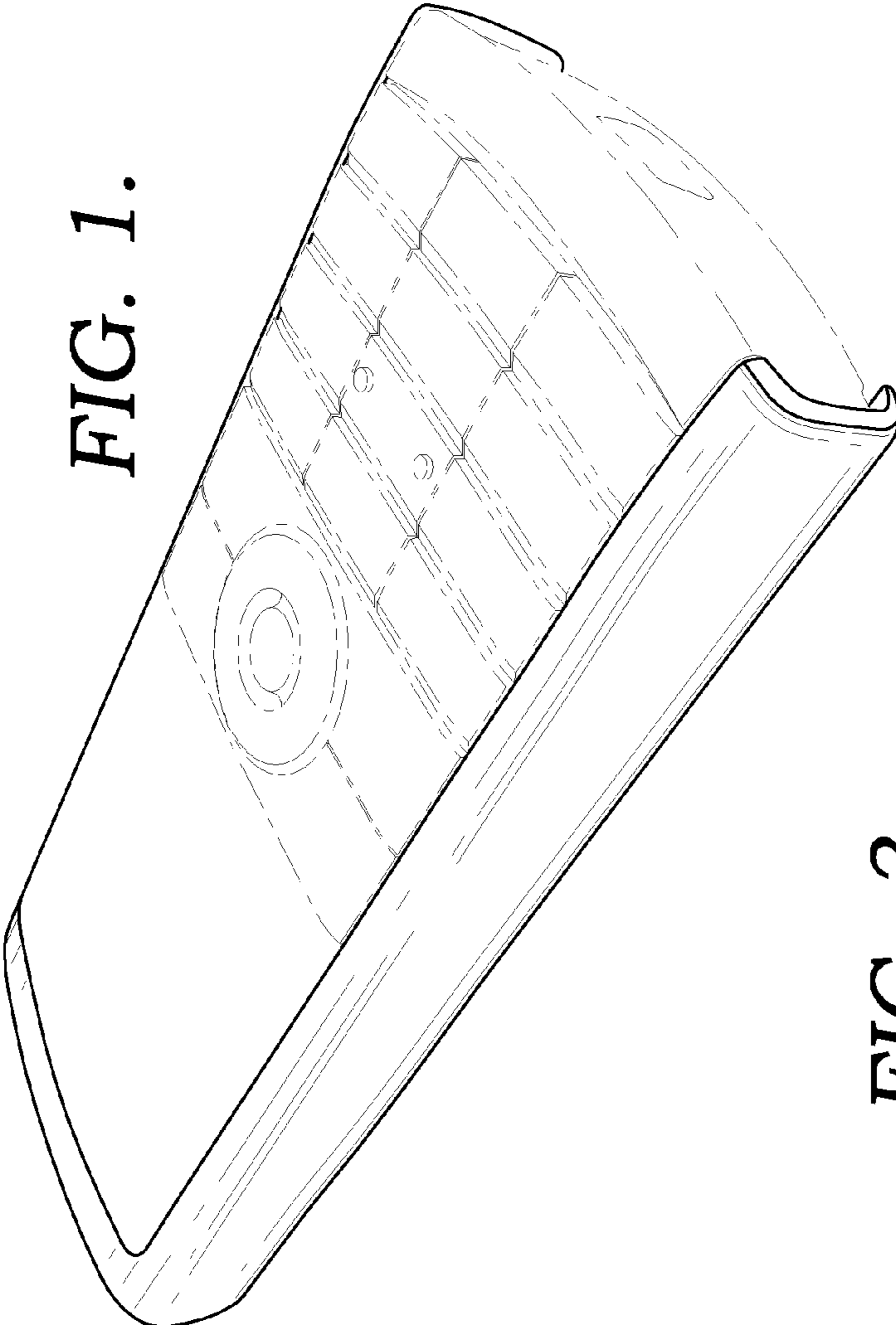

FIG. 1.

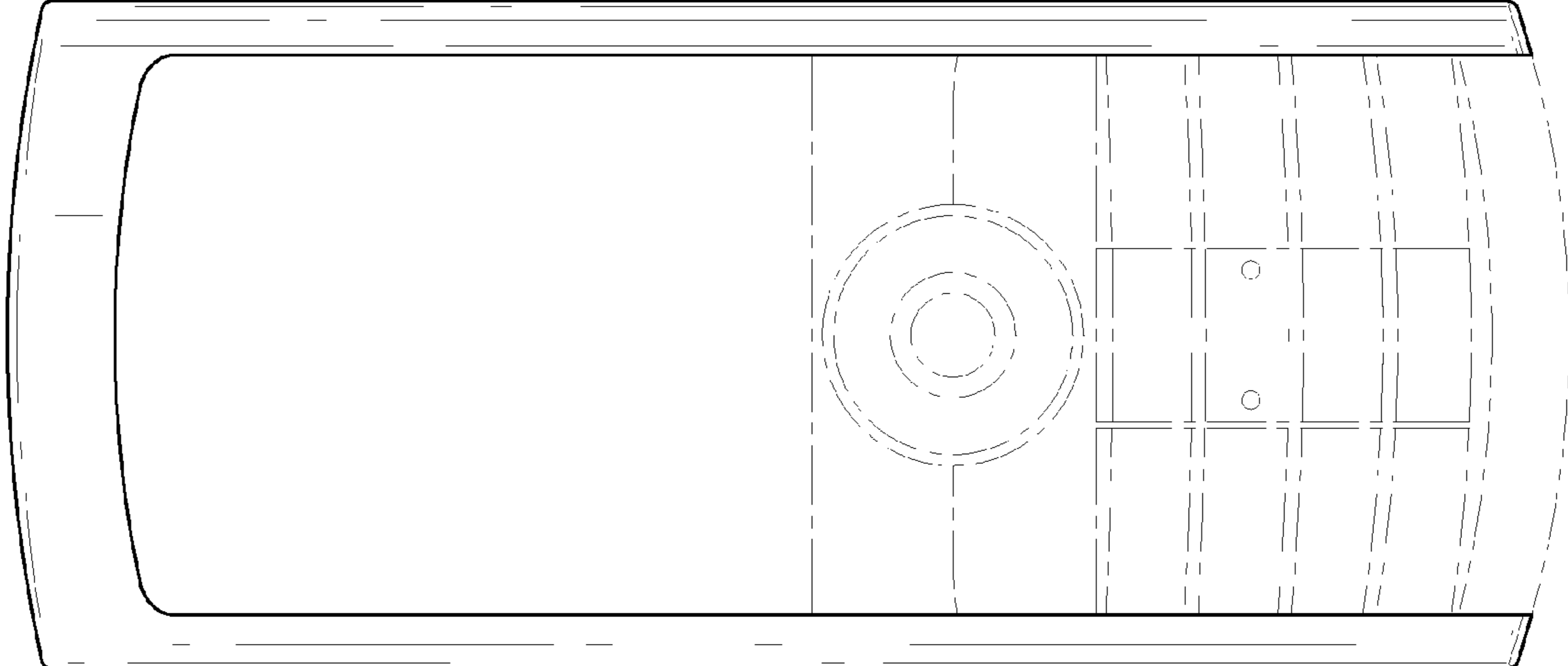
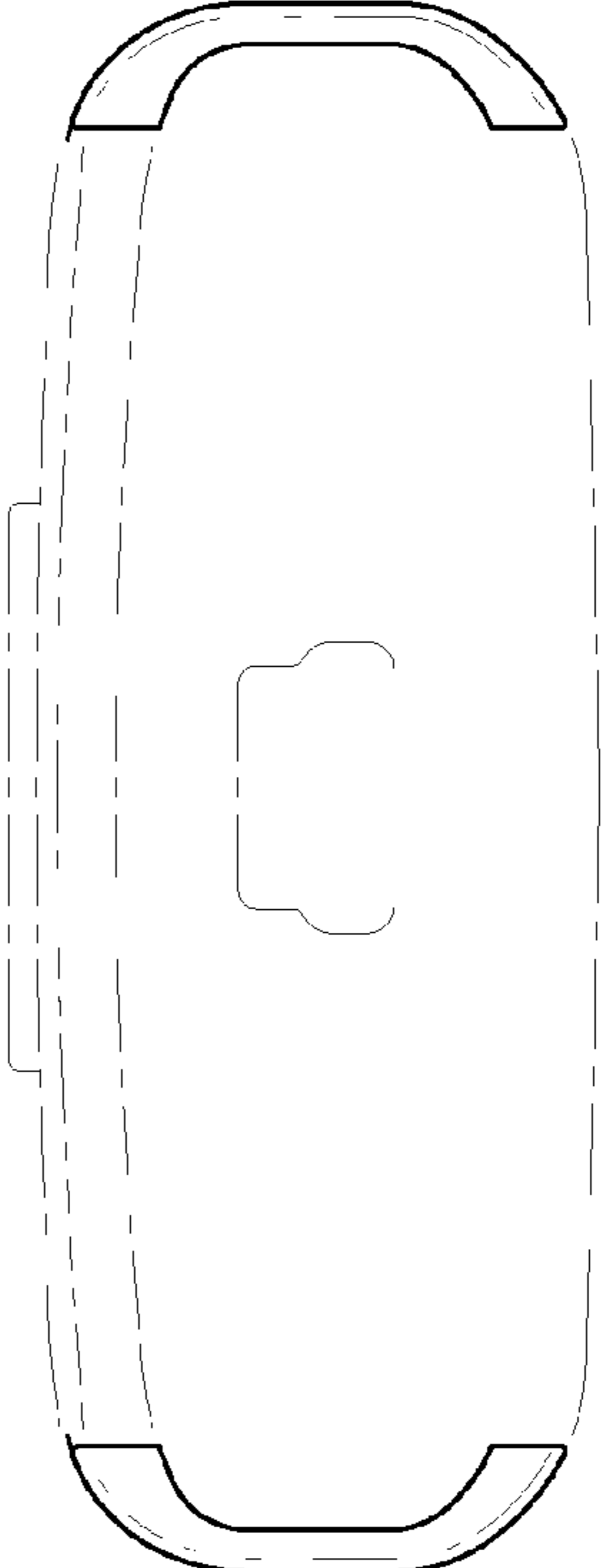

FIG. 2.

FIG. 3.



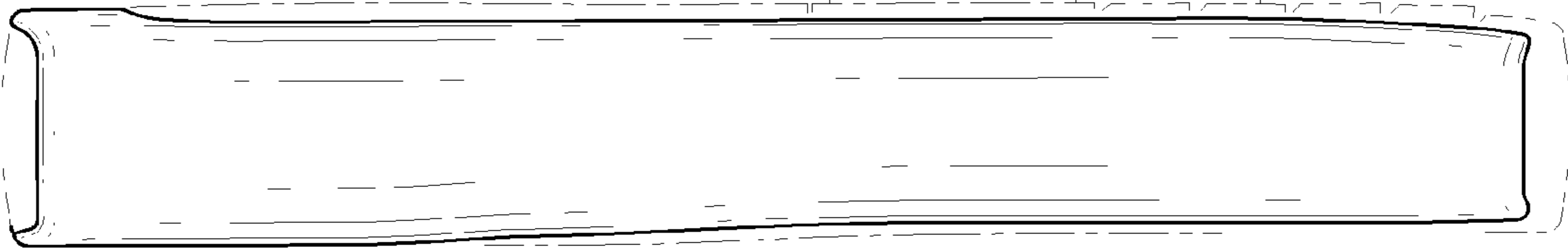

FIG. 4.

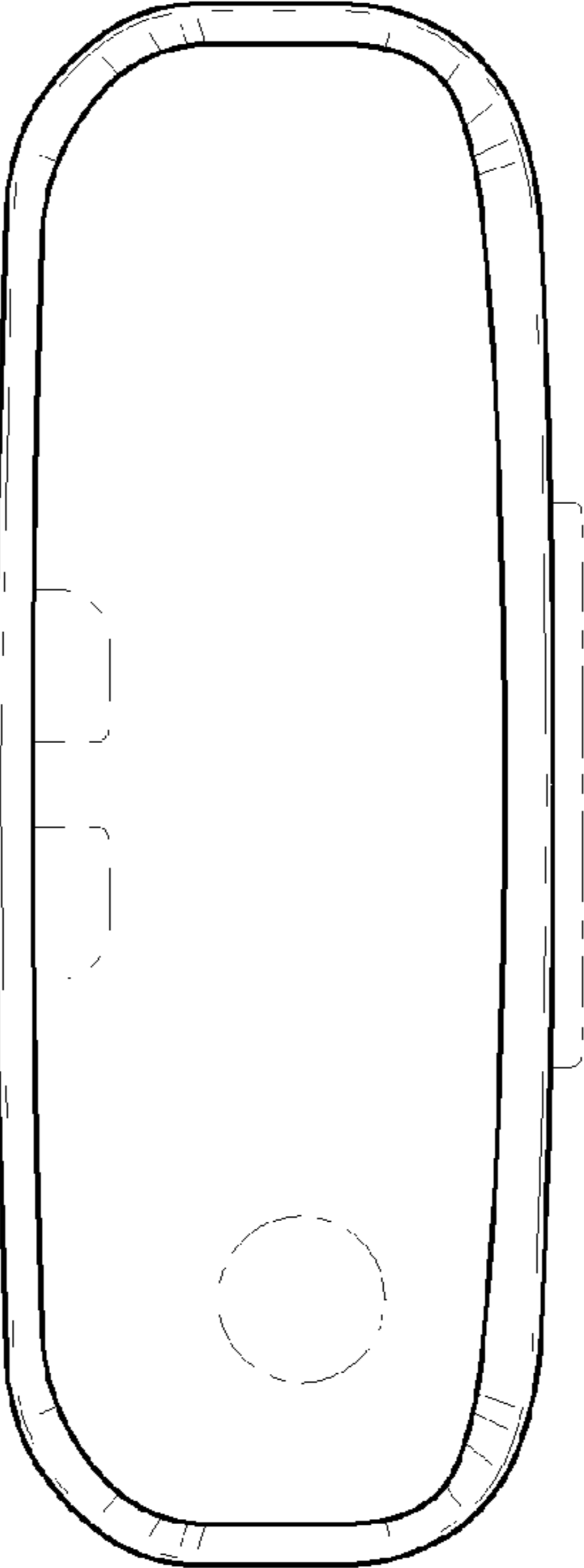

FIG. 5.

FIG. 6.

