



US00D618587S

(12) **United States Design Patent**
Weldon

(10) **Patent No.:** **US D618,587 S**

(45) **Date of Patent:** **** Jun. 29, 2010**

(54) **JEAN CLIP**

(76) **Inventor:** **Jennifer Weldon**, 39 Farmside Dr.,
Pembroke, MA (US) 02359

(**) **Term:** **14 Years**

(21) **Appl. No.:** **29/316,693**

(22) **Filed:** **Oct. 23, 2009**

(51) **LOC (9) Cl.** **02-07**

(52) **U.S. Cl.** **D11/215; D11/74**

(58) **Field of Classification Search** D11/74,
D11/1, 40, 44, 48, 56, 79, 81, 87, 200, 202,
D11/212, 204, 214, 215; D2/895, 976; D99/25;
24/1, 72.1, 564, 560, 563, 546, 555; 2/217,
2/218, 144

See application file for complete search history.

(56) **References Cited**

U.S. PATENT DOCUMENTS

- 271,891 A * 2/1883 McDermott 24/316
- D85,346 S * 10/1931 Riker D2/976
- 2,107,516 A * 2/1938 Bishop 24/72.1
- D127,898 S * 6/1941 Behr D28/42
- D150,960 S * 9/1948 Katz D11/44
- D168,806 S * 2/1953 Rearick D11/45
- D174,279 S * 3/1955 Katz D11/44
- D204,133 S * 3/1966 Lee D11/215
- D277,534 S * 2/1985 Warmath D6/328

- 5,079,808 A * 1/1992 Brown 24/67.7
- D413,542 S * 9/1999 Guarino D11/74
- D439,202 S * 3/2001 Takabayashi D11/215
- D457,465 S * 5/2002 Hollingsworth et al. D11/215
- 7,237,306 B1 * 7/2007 Flowers et al. 24/72.1
- 2006/0010661 A1 * 1/2006 Murphy 24/545
- 2007/0192998 A1 * 8/2007 Ryder 24/1

* cited by examiner

Primary Examiner—Robert M Spear

Assistant Examiner—Rashida C McCoy

(74) *Attorney, Agent, or Firm*—Lambert & Associates; Adam
J. Bruno; Gary E. Lambert

(57) **CLAIM**

I claim the ornamental design for the jean clip, as shown and
described.

DESCRIPTION

FIG. 1 is a back side perspective view of the jean clip showing
my new design;

FIG. 2 is a back view thereof;

FIG. 3 is a front view thereof;

FIG. 4 is a top plan view thereof;

FIG. 5 is bottom view thereof;

FIG. 6 is a left side view thereof; and,

FIG. 7 is a right side view thereof.

1 Claim, 2 Drawing Sheets

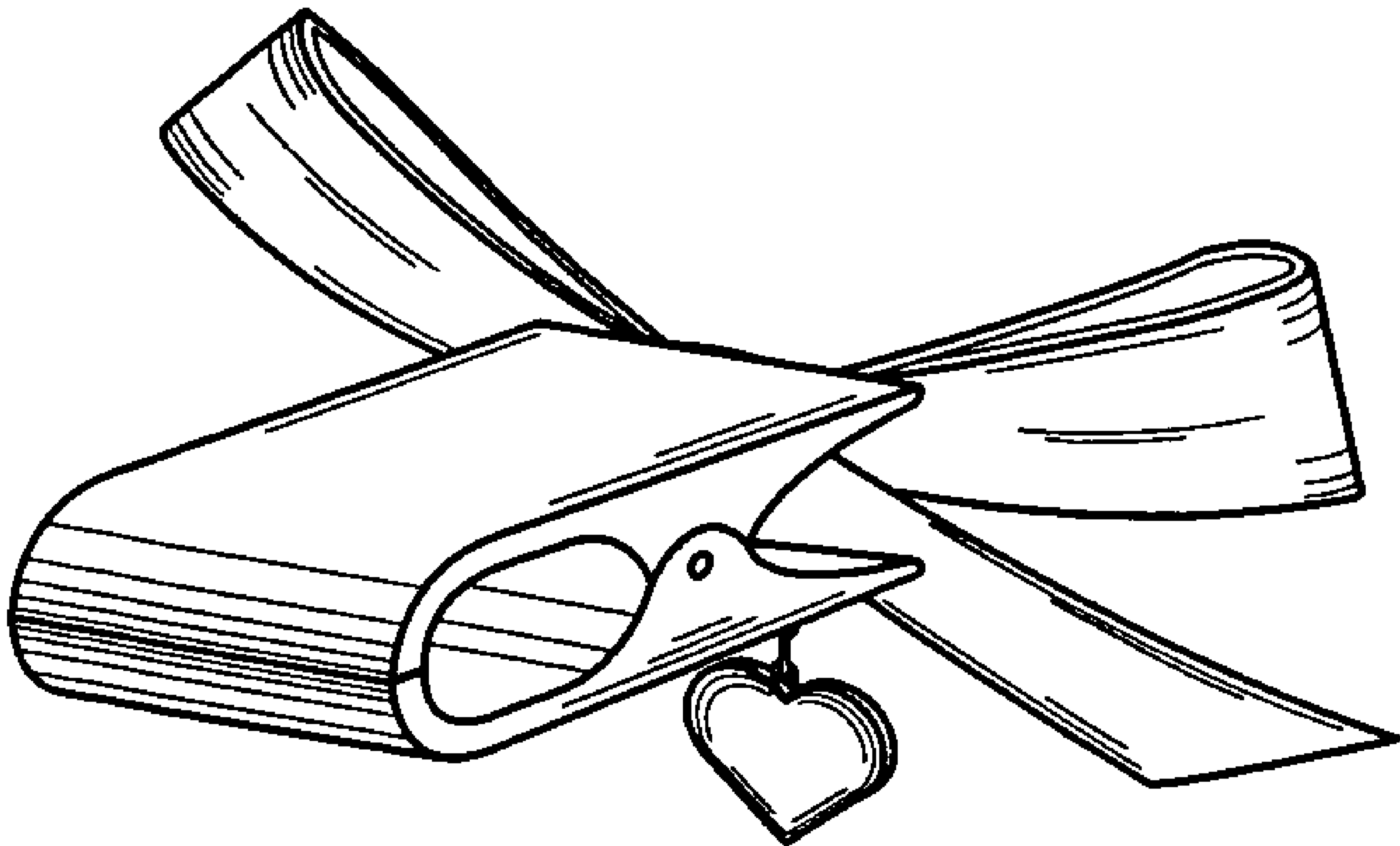

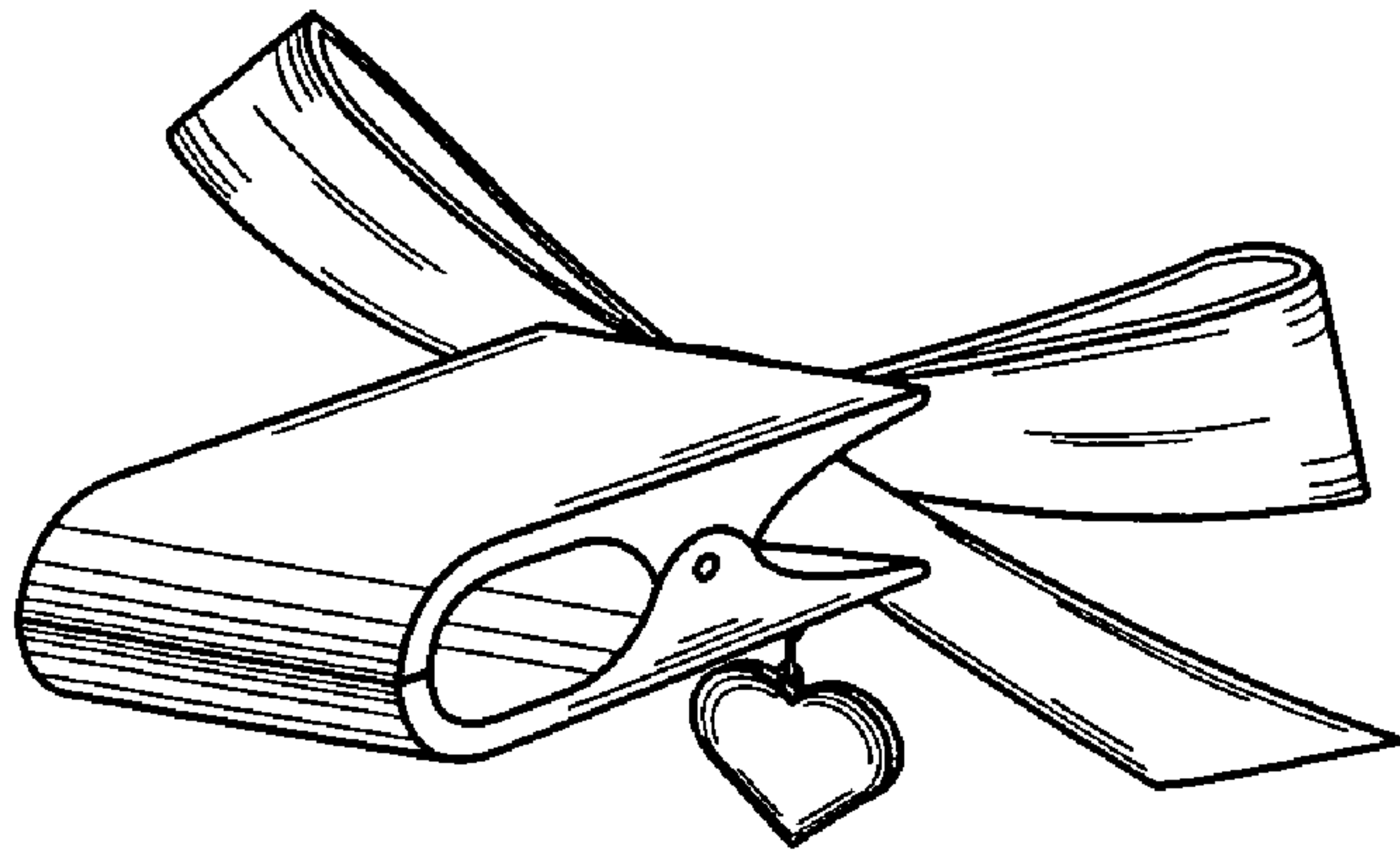

FIG. 1

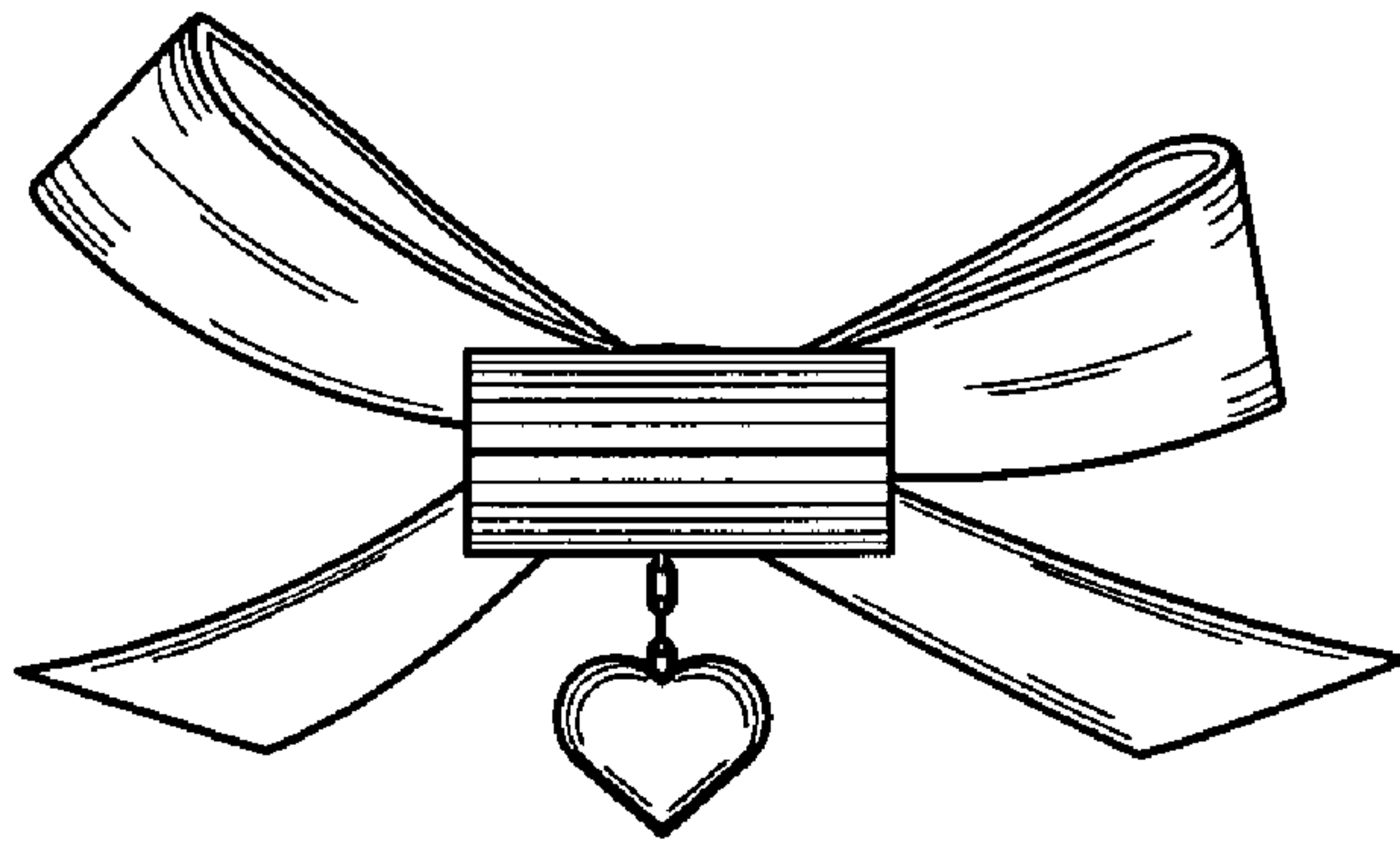

FIG. 2

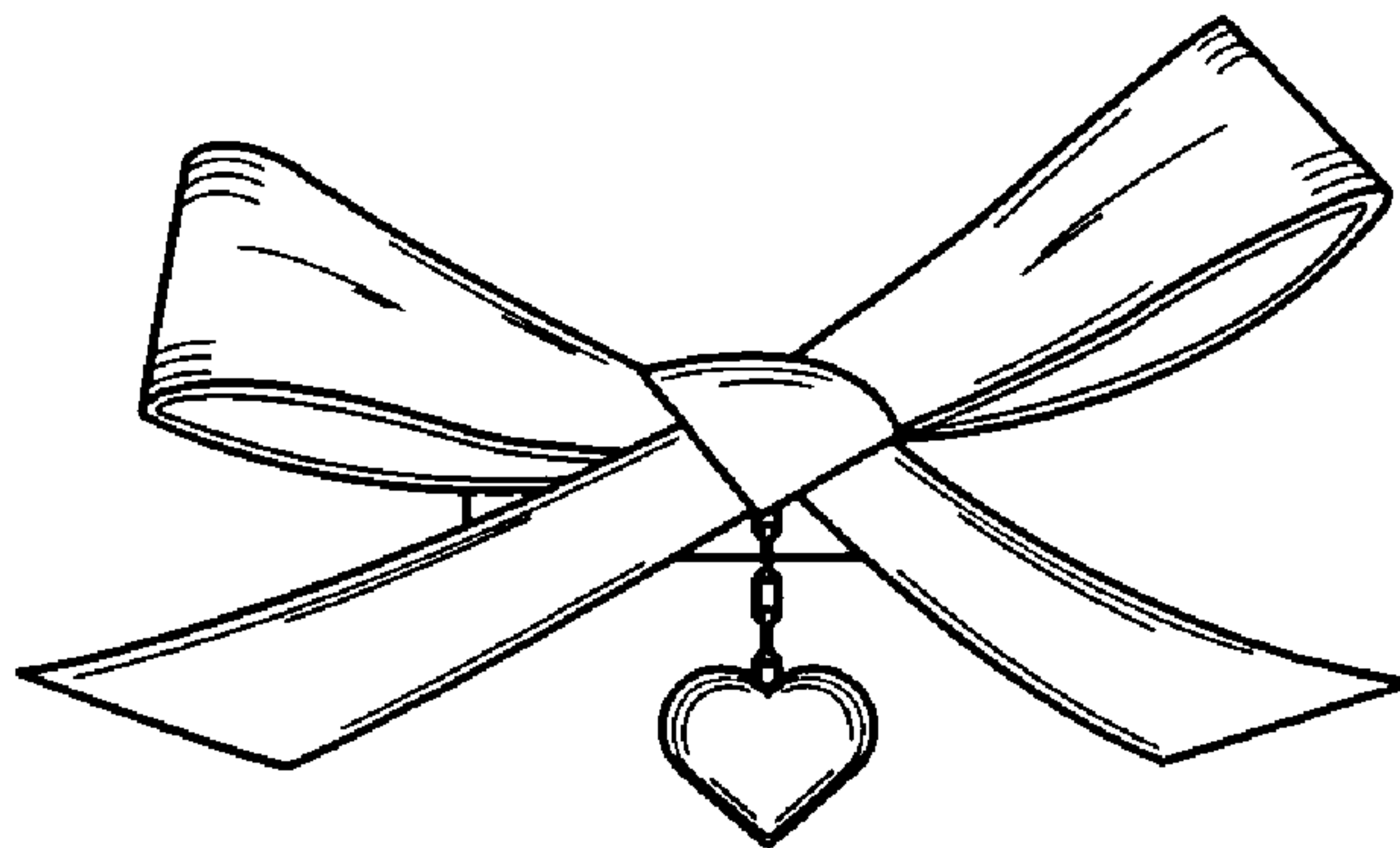

FIG. 3

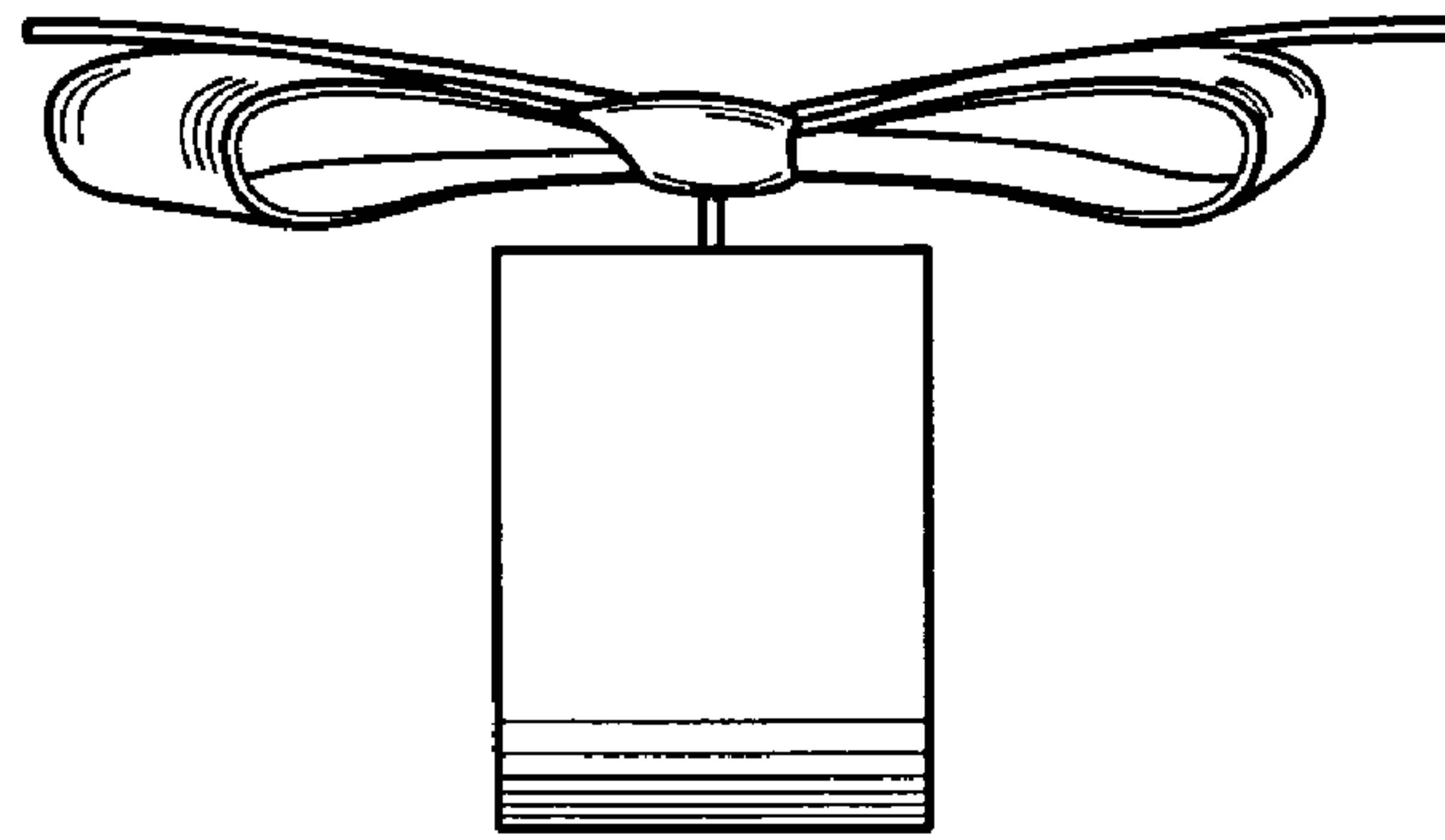

FIG. 4

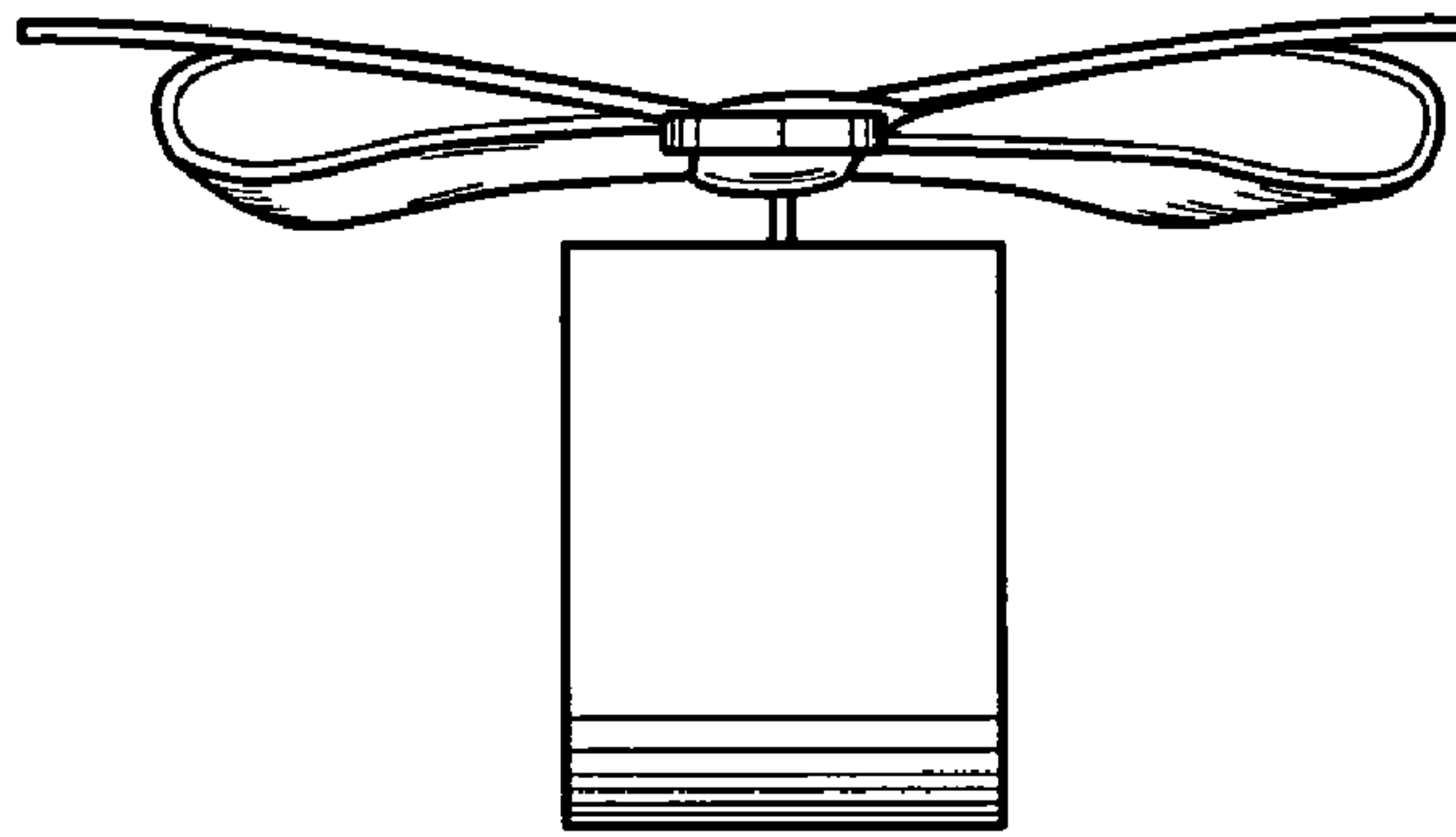

FIG. 5

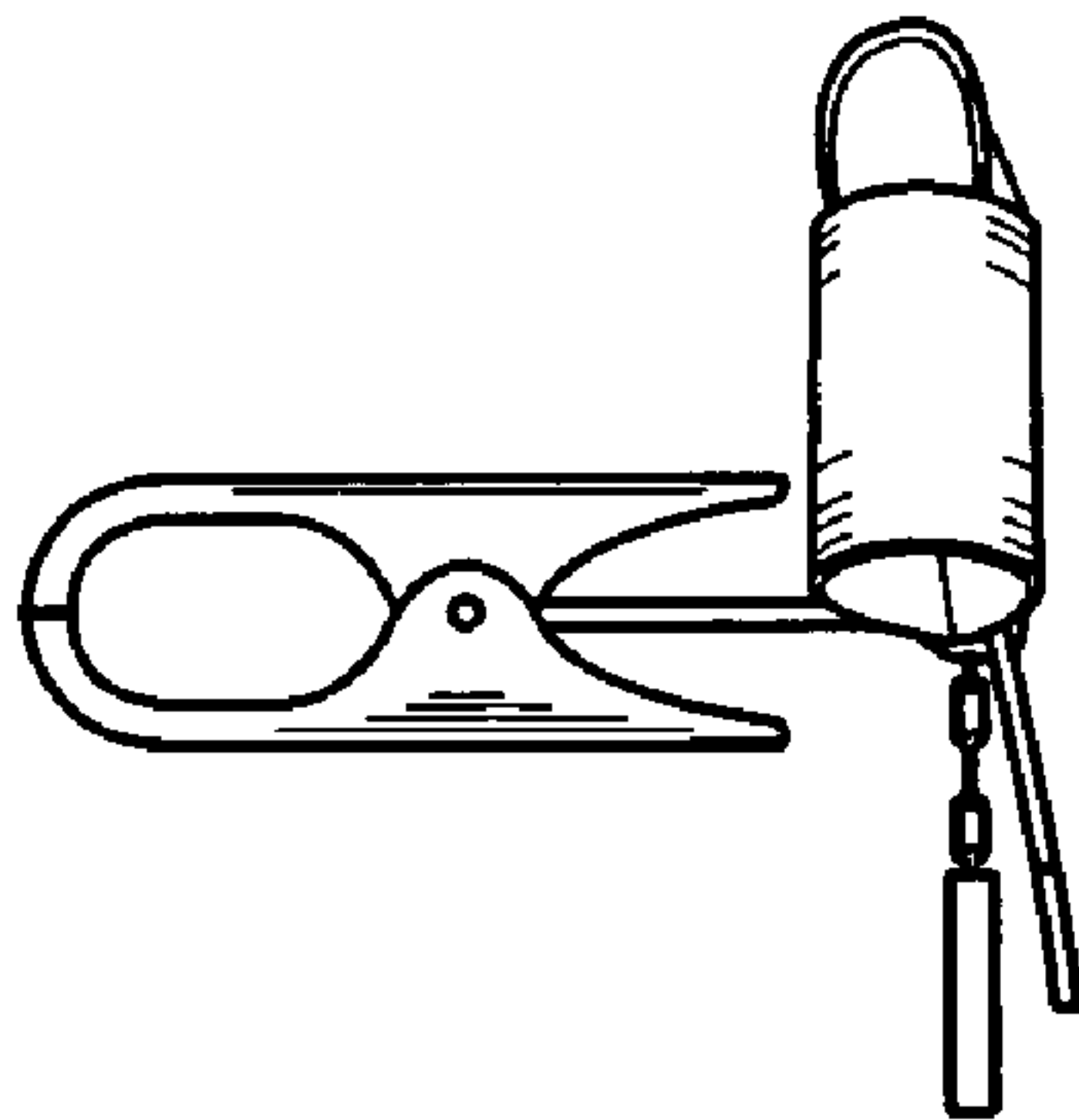

FIG. 6

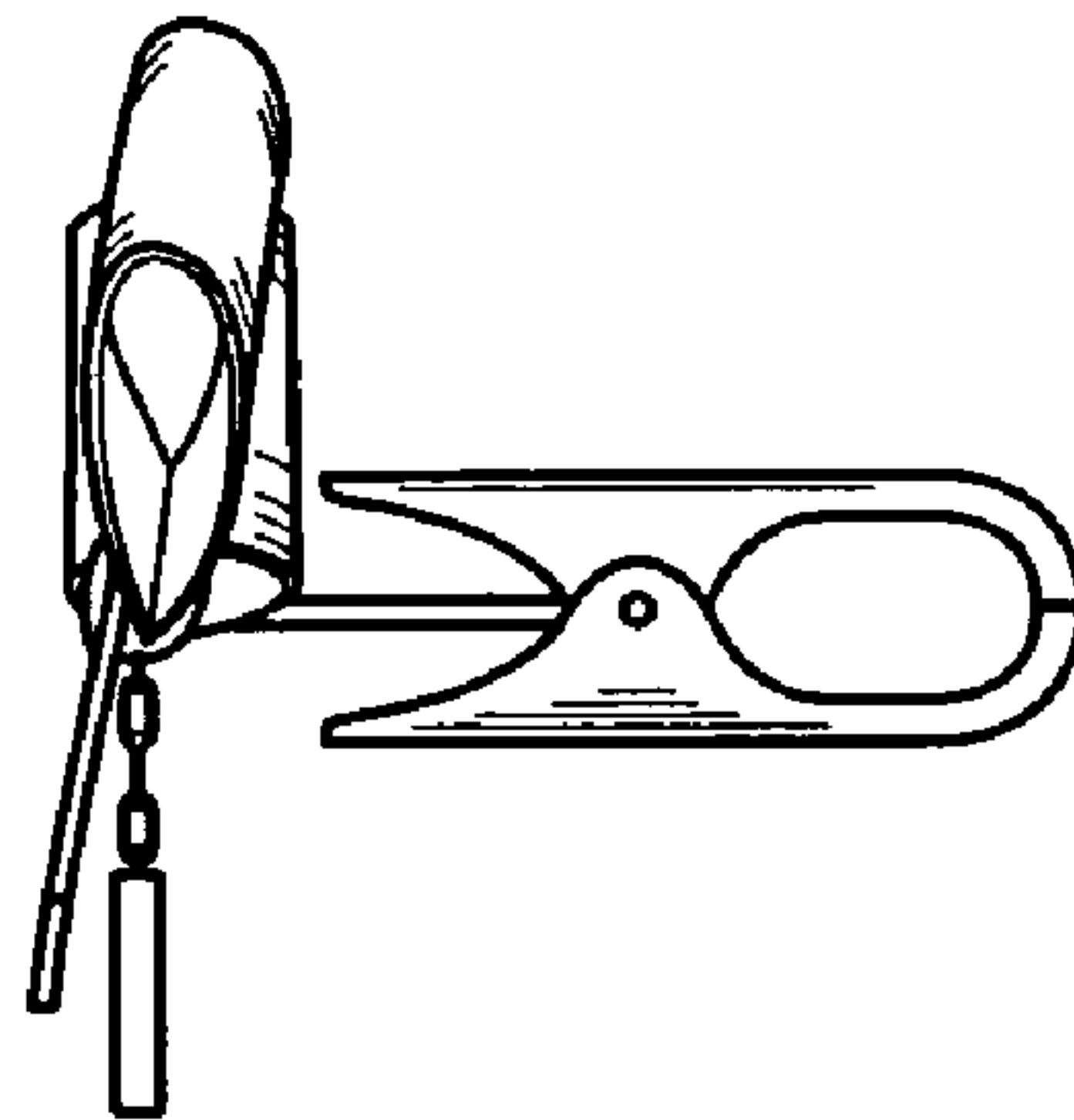

FIG. 7