



US00D618515S

(12) **United States Design Patent**
Roth et al.

(10) **Patent No.:** **US D618,515 S**
(45) **Date of Patent:** **** Jun. 29, 2010**

(54) **CONTAINER**

(76) Inventors: **Donna Roth**, 10 Cordage Park Cir.,
Suite 212, Plymouth, MA (US) 02360;
Henry Roth, 10 Cordage Park Cir., Suite
212, Plymouth, MA (US) 02360

(**) Term: **14 Years**

(21) Appl. No.: **29/306,924**

(22) Filed: **Apr. 18, 2008**

(51) **LOC (9) Cl.** **07-07**

(52) **U.S. Cl.** **D7/629**

(58) **Field of Classification Search** D7/601,
D7/602, 629, 538-542; D9/424-432, 761;
220/574-575, 780-806

See application file for complete search history.

(56) **References Cited**

U.S. PATENT DOCUMENTS

4,147,277	A *	4/1979	Bateman et al.	220/574.2
5,419,451	A *	5/1995	Bitel, Jr.	220/575
D395,985	S *	7/1998	Krupa et al.	D7/629
D446,085	S *	8/2001	Dretzka	D7/629
D451,018	S *	11/2001	Chen et al.	D9/428
D489,579	S *	5/2004	Wright	D7/629
D527,227	S *	8/2006	Bertulis	D7/629
D530,625	S *	10/2006	Darin	D9/761
D557,993	S *	12/2007	Stamper et al.	D7/629
2005/0006390	A1 *	1/2005	Wang	220/256.1
2005/0035125	A1 *	2/2005	Bae	220/784
2006/0201952	A1 *	9/2006	Hakim	220/574

* cited by examiner

Primary Examiner—Terry A Wallace
(74) *Attorney, Agent, or Firm*—Steven M. Jensen; Edwards
Angell Palmer & Dodge LLP

(57) **CLAIM**

We claim a new ornamental design for a container, as shown
and described.

DESCRIPTION

FIG. 1 is a perspective view of a container according to a first
preferred embodiment of our new design;

FIG. 2 is top plan view of the container of FIG. 1;

FIG. 3 is a bottom plan view of the container of FIG. 1;

FIG. 4 is a front elevational view of the container of FIG. 1;

FIG. 5 is a rear elevational view of the container of FIG. 1;

FIG. 6 is a right side elevational view of the container of FIG.
1;

FIG. 7 is a left side elevational view of the container of FIG.
1;

FIG. 8 is a perspective view of a container according to a
second preferred embodiment of our new design;

FIG. 9 is top plan view of the container of FIG. 8;

FIG. 10 is a bottom plan view of the container of FIG. 8;

FIG. 11 is a front elevational view of the container of FIG. 8;

FIG. 12 is a rear elevational view of the container of FIG. 8;

FIG. 13 is a right side elevational view of the container of FIG.
8; and,

FIG. 14 is a left side elevational view of the container of FIG.
8.

The broken lines in FIGS. 1-14 represent environment and
are for illustrative purposes only and do not constitute part of
the claimed design.

1 Claim, 8 Drawing Sheets

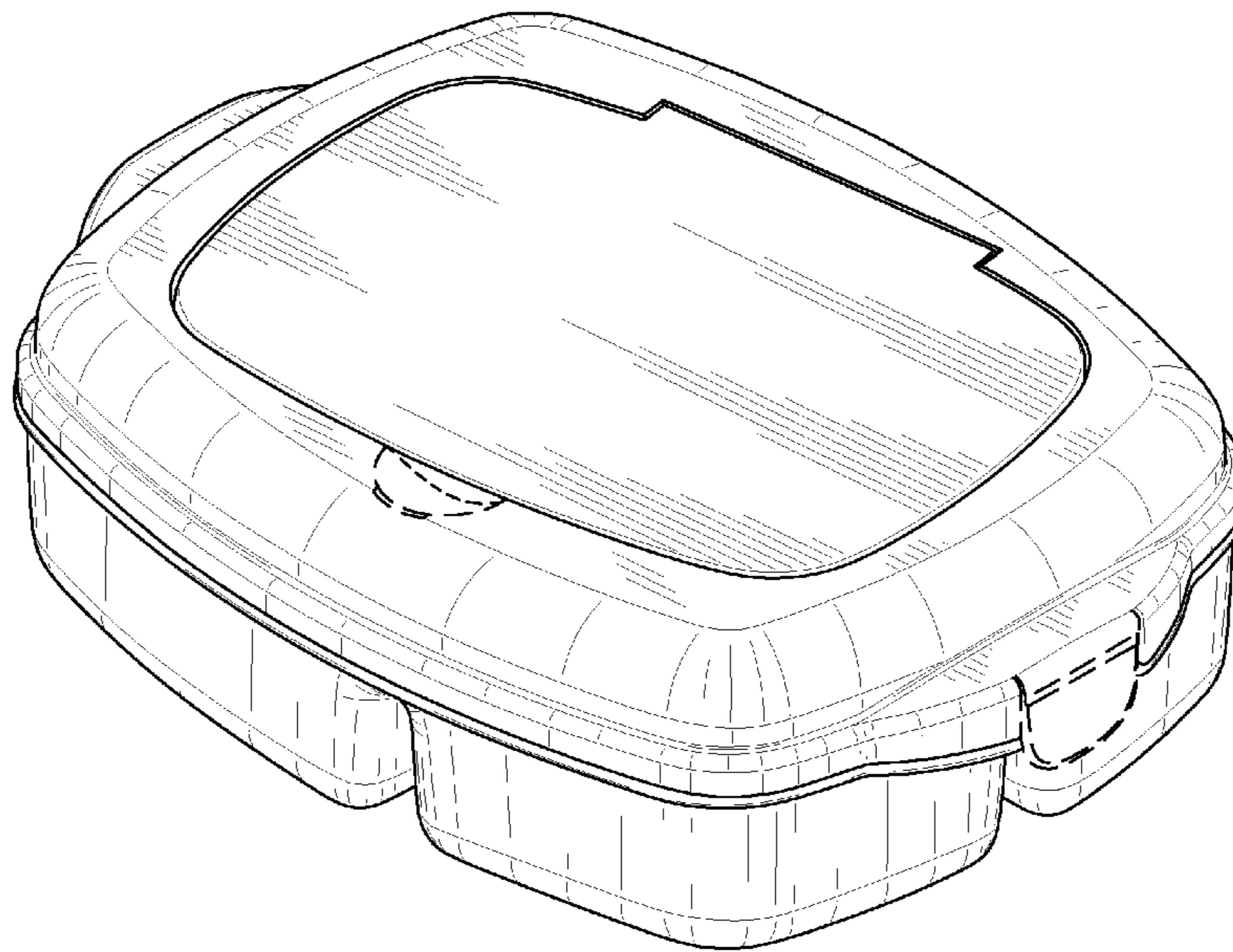

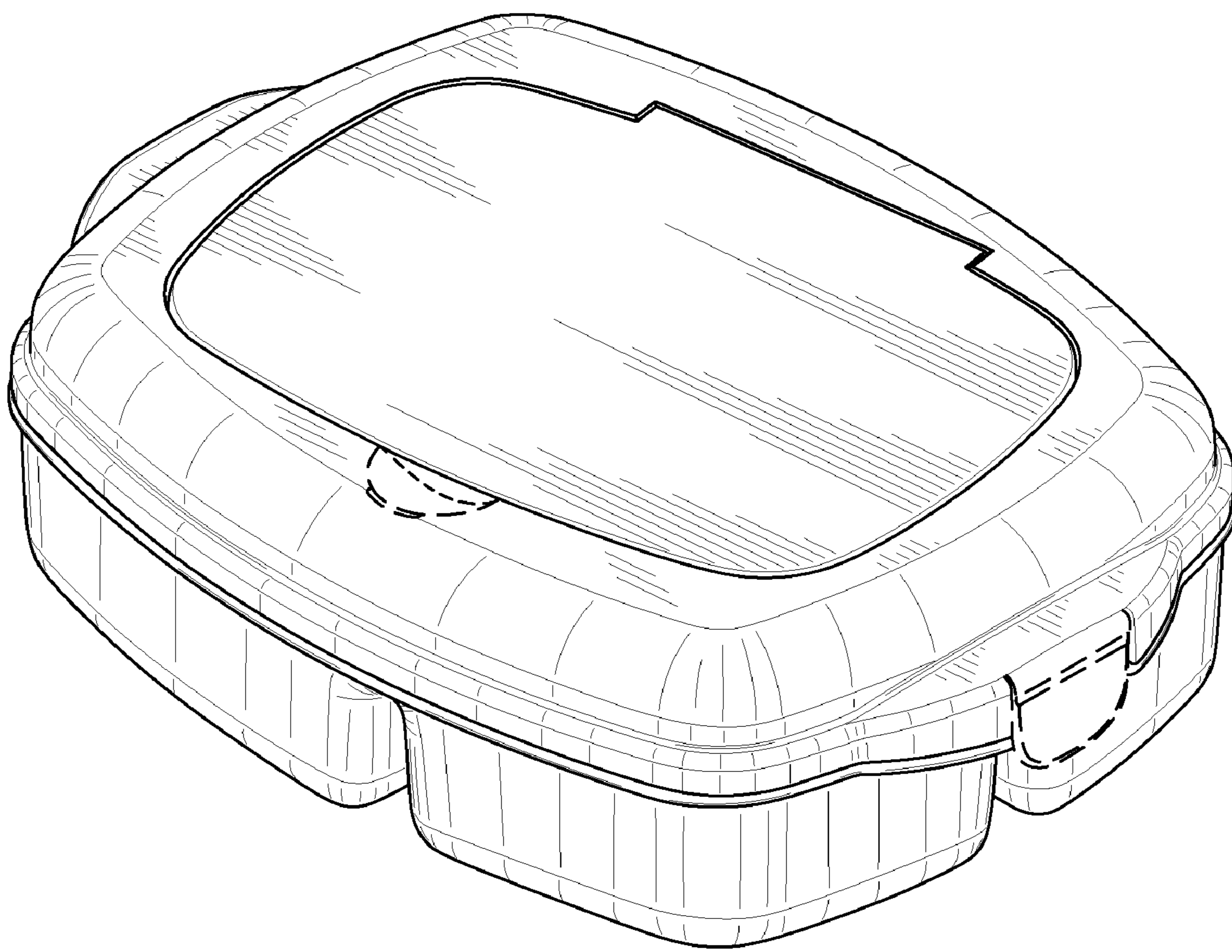

FIG. 1

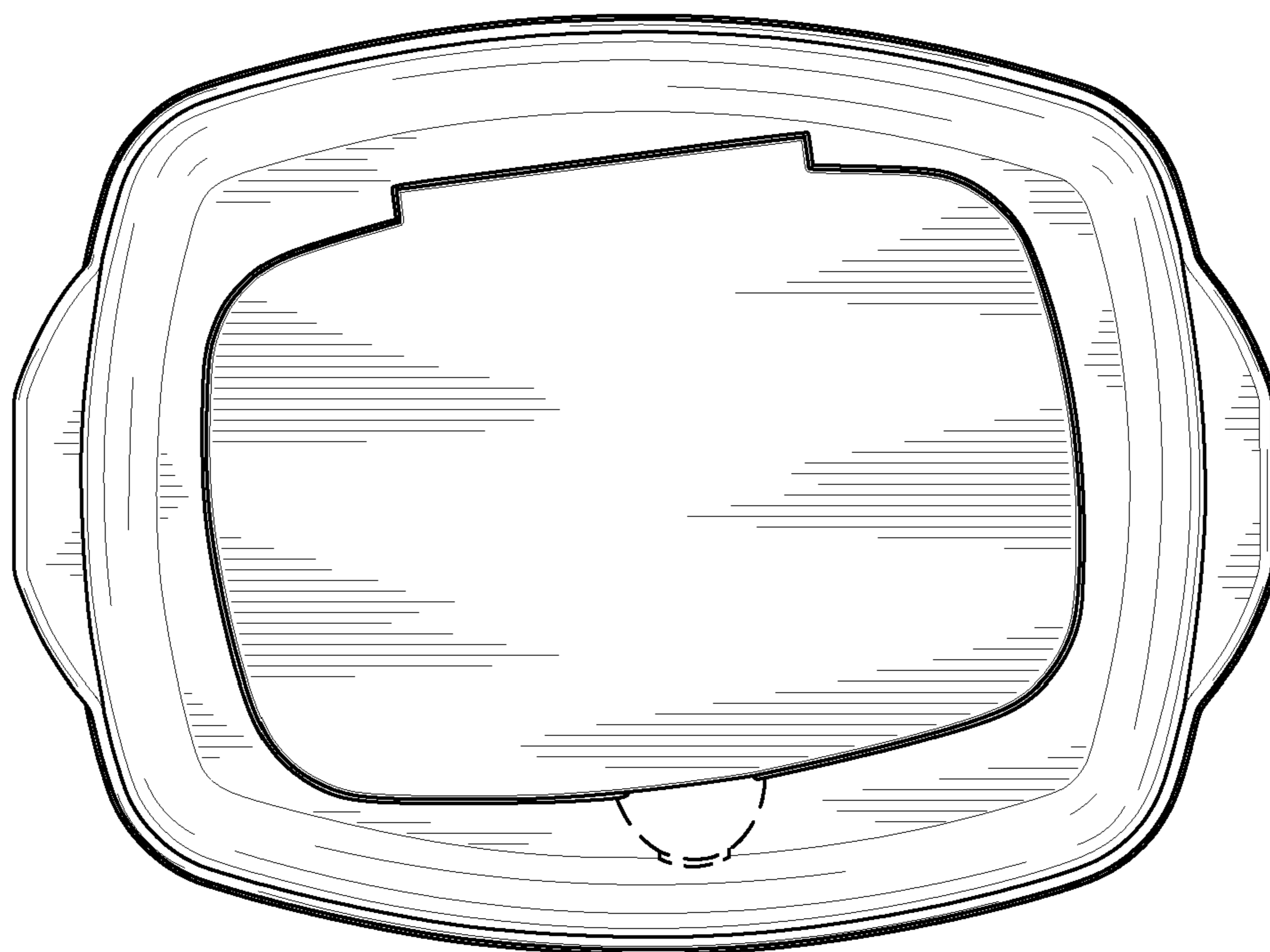

FIG. 2

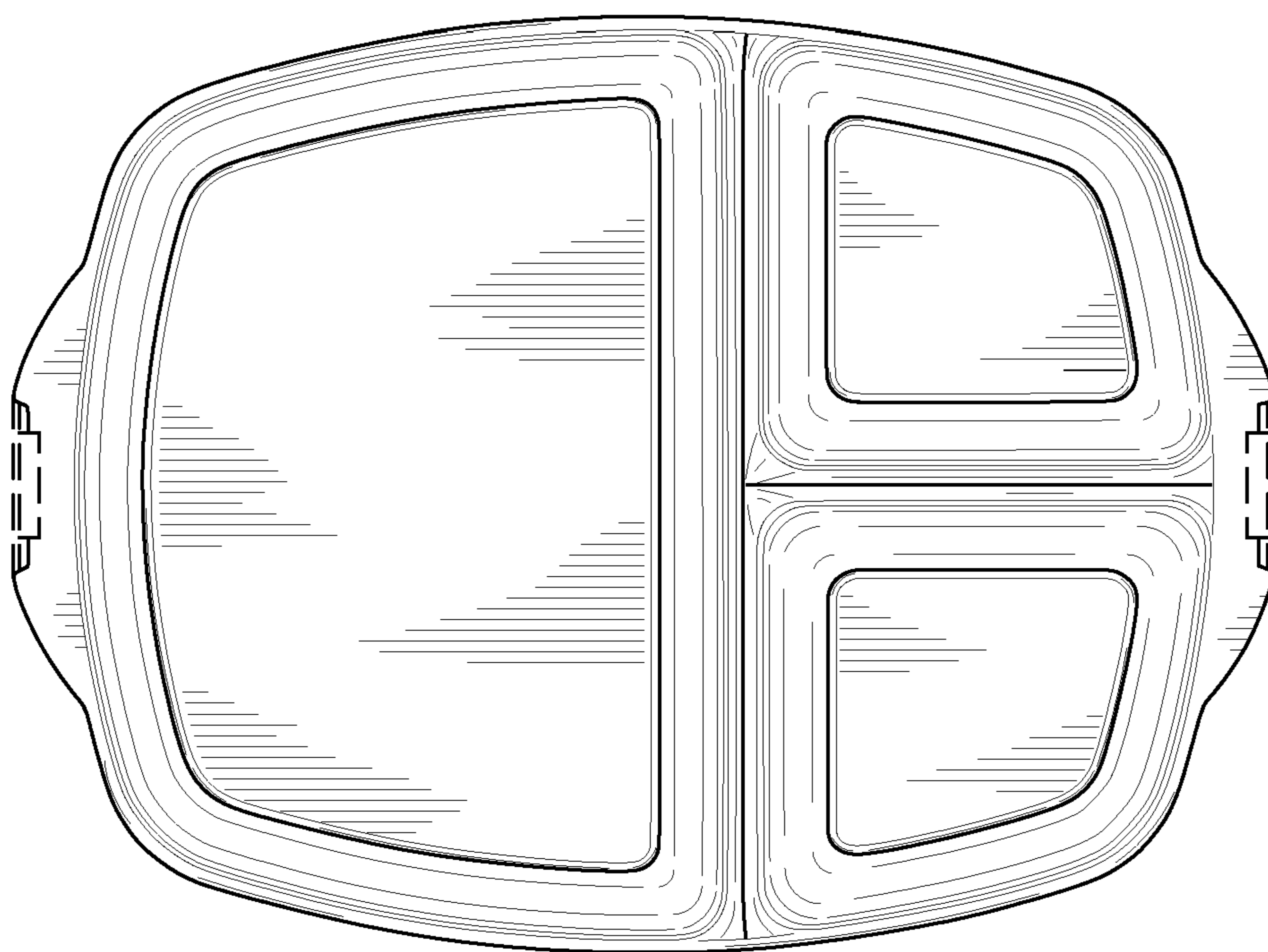

FIG. 3

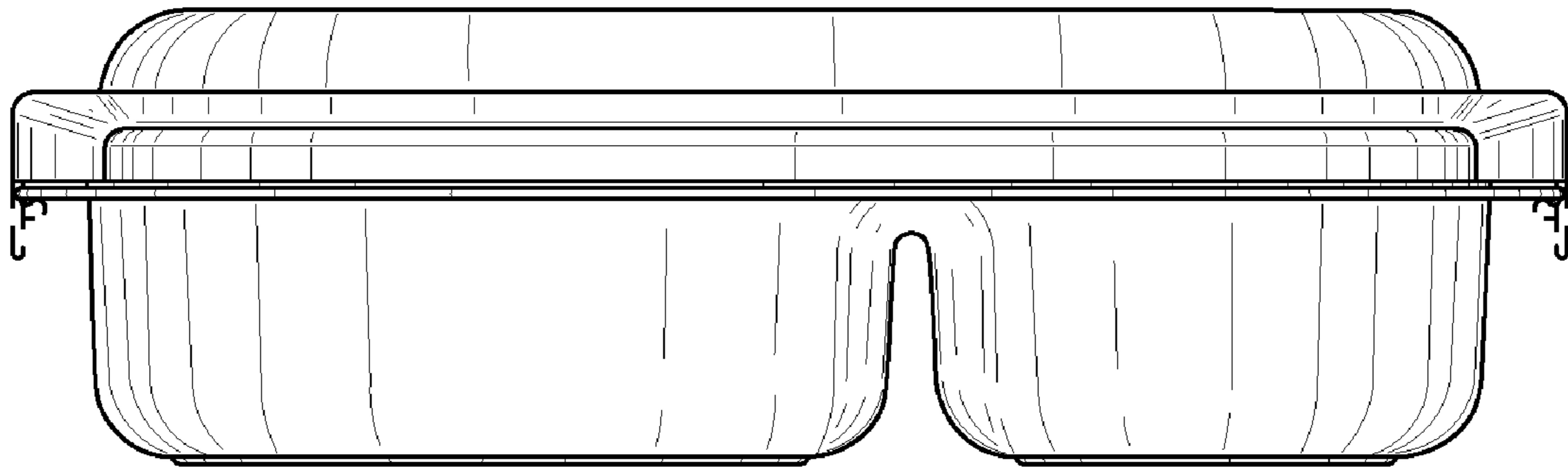

FIG. 4

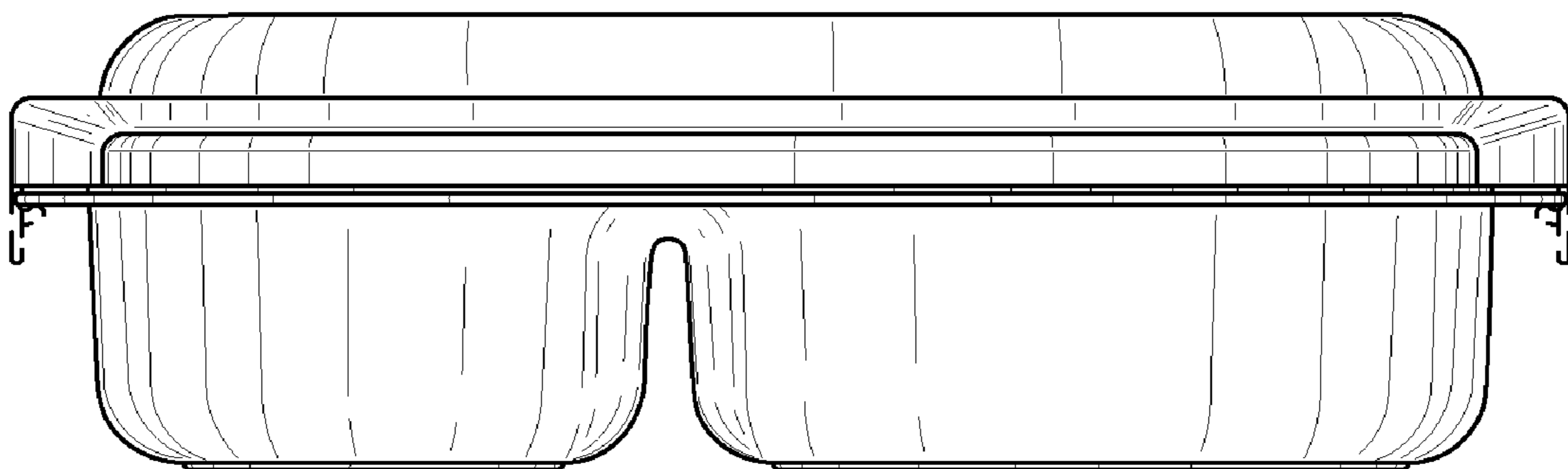

FIG. 5

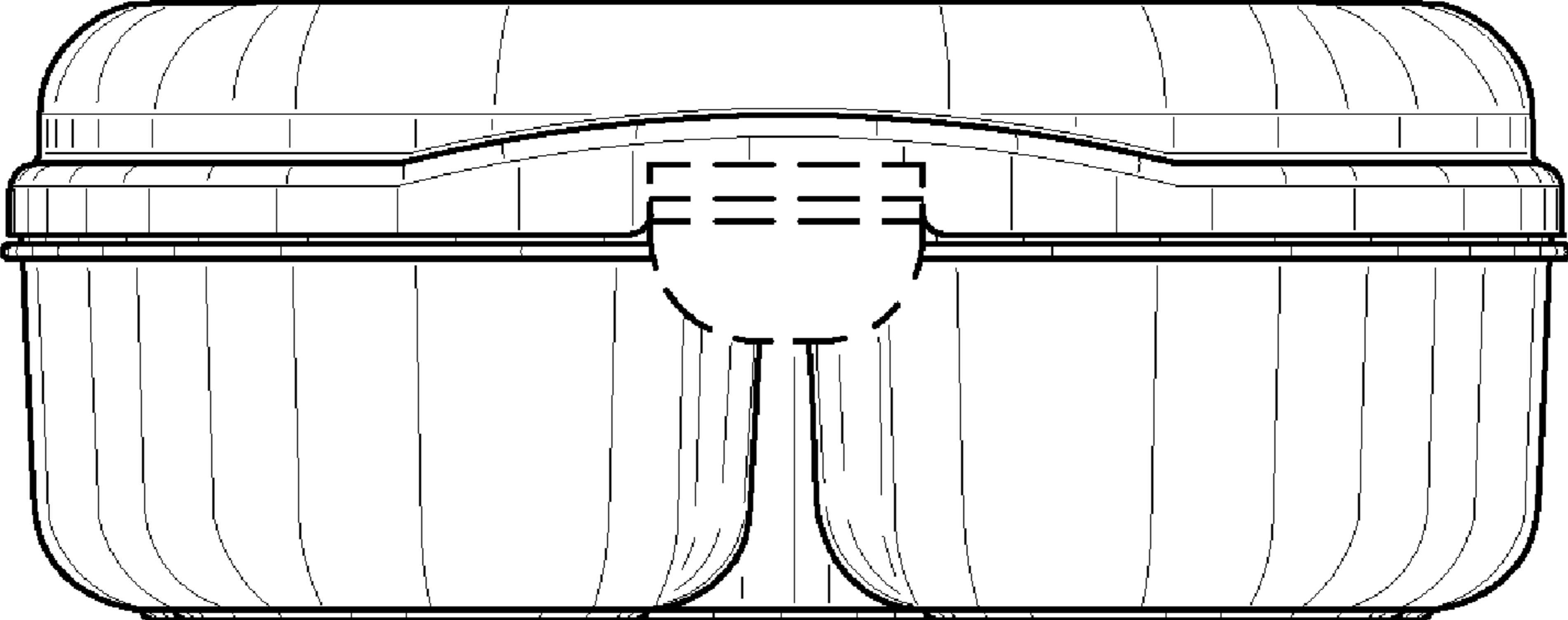

FIG. 6

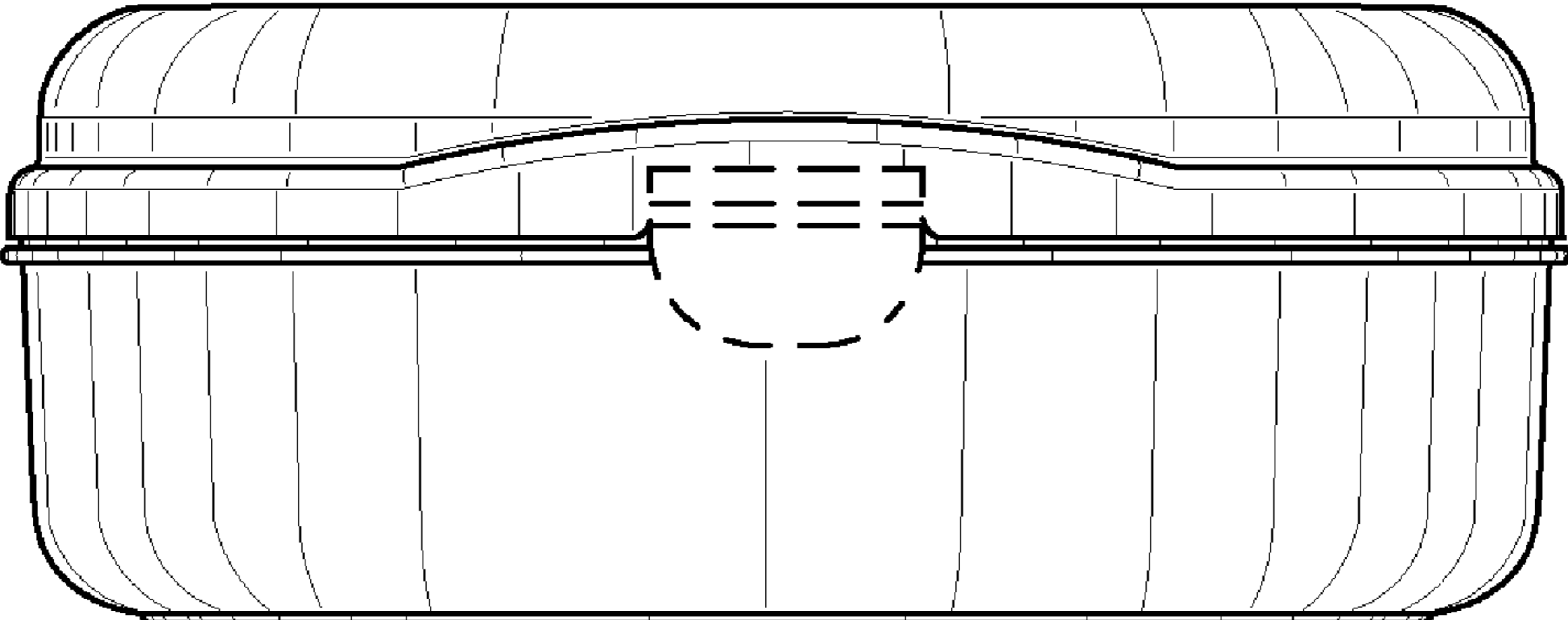

FIG. 7

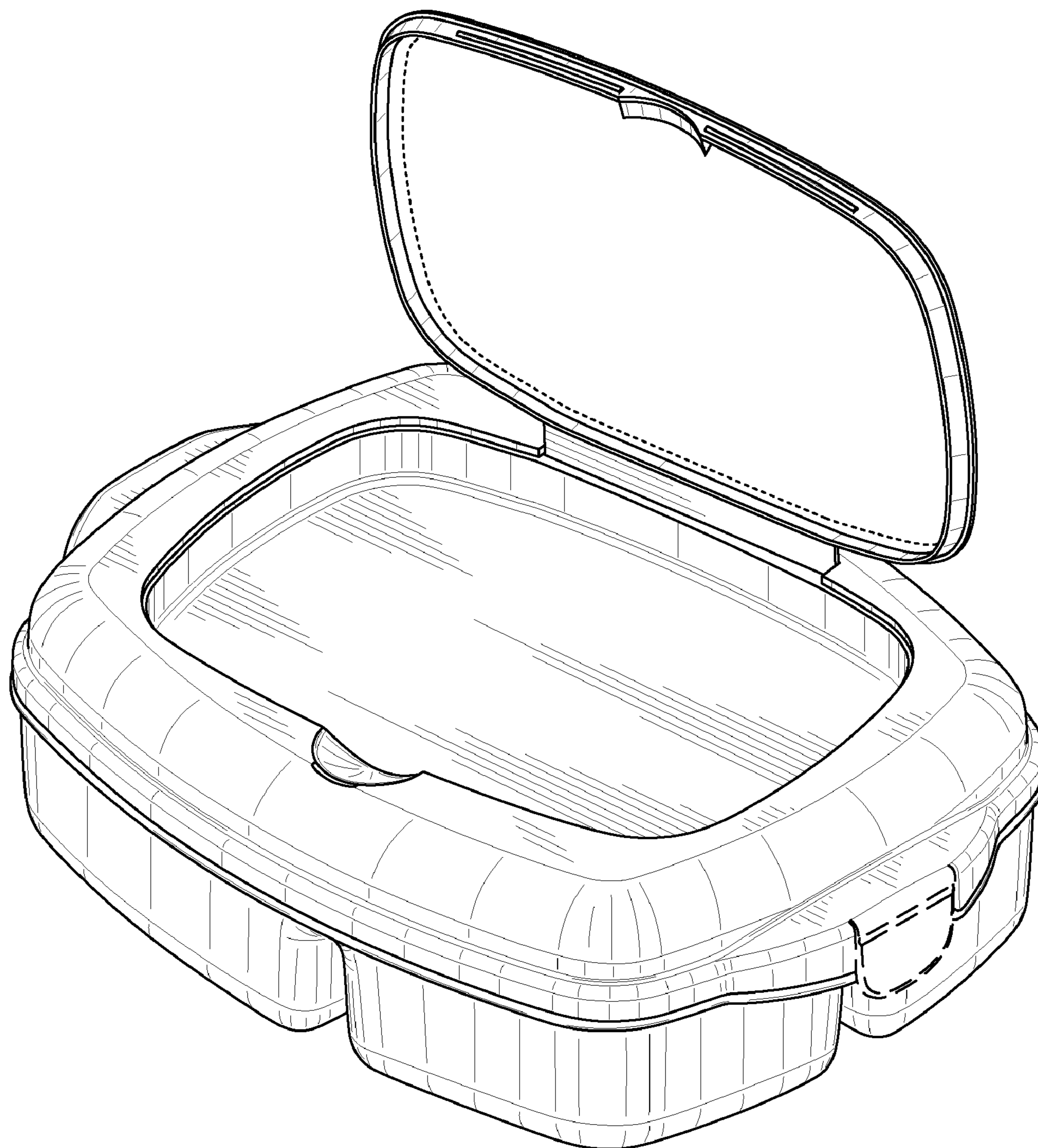

FIG. 8

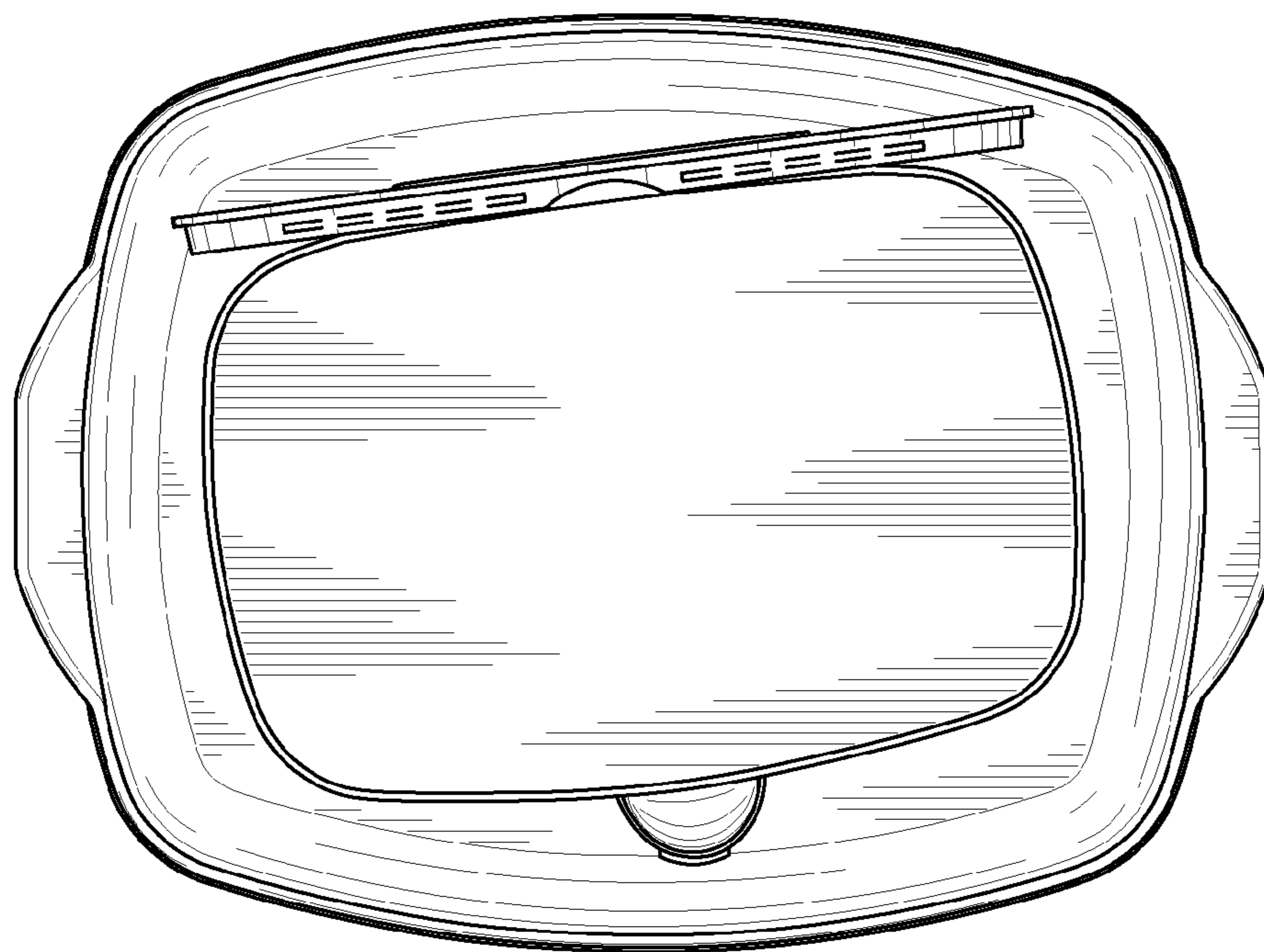

FIG. 9

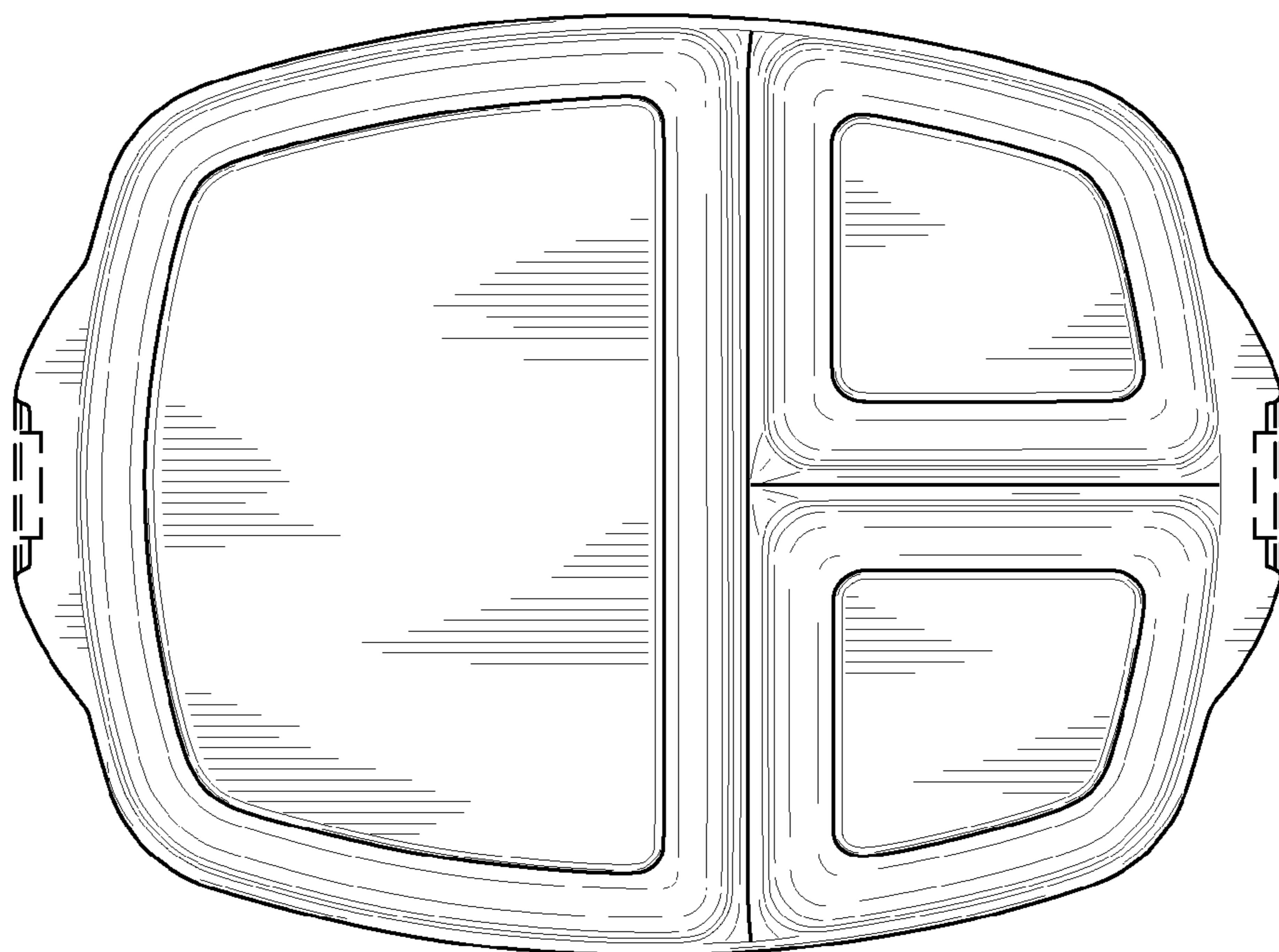

FIG. 10

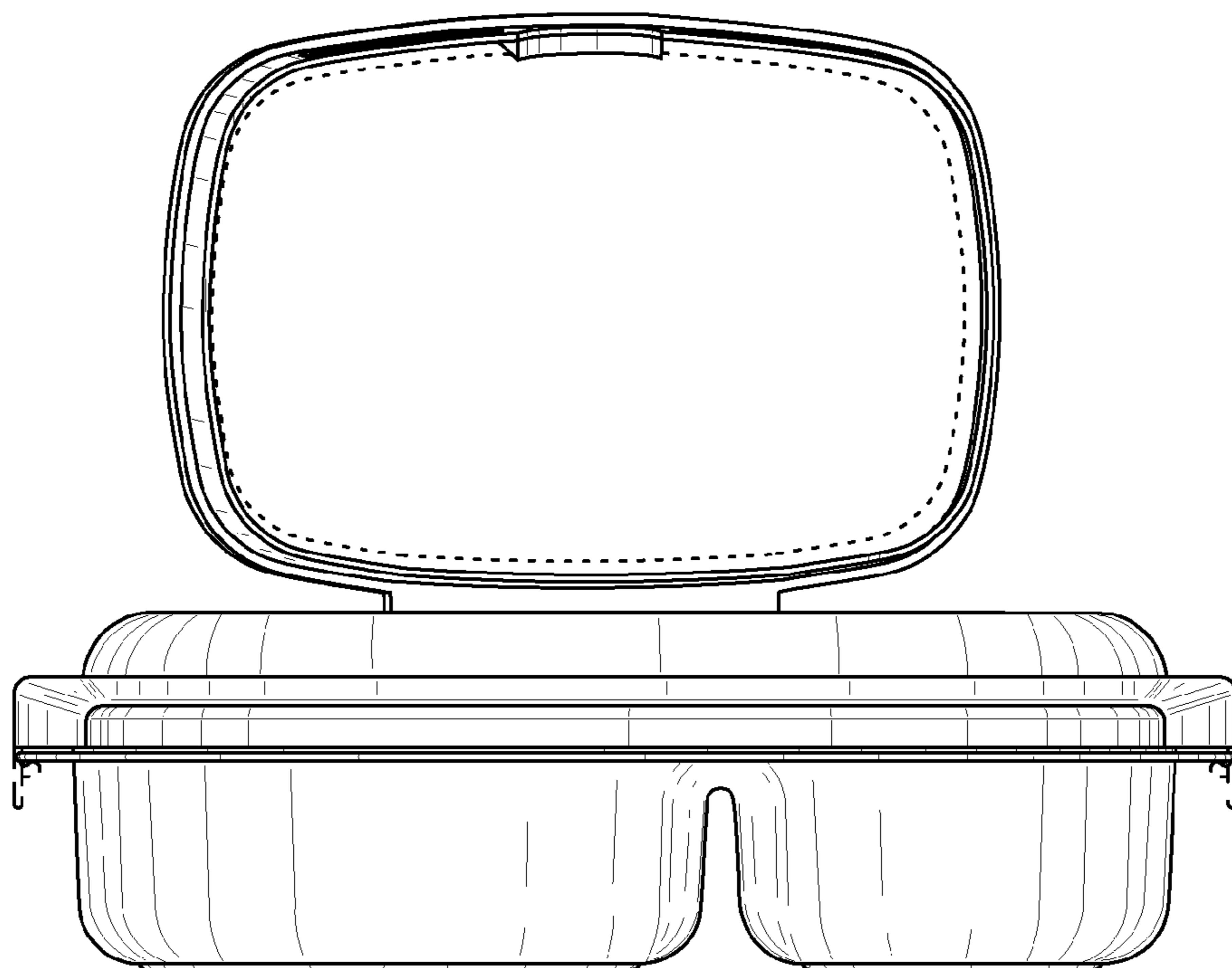

FIG. 11

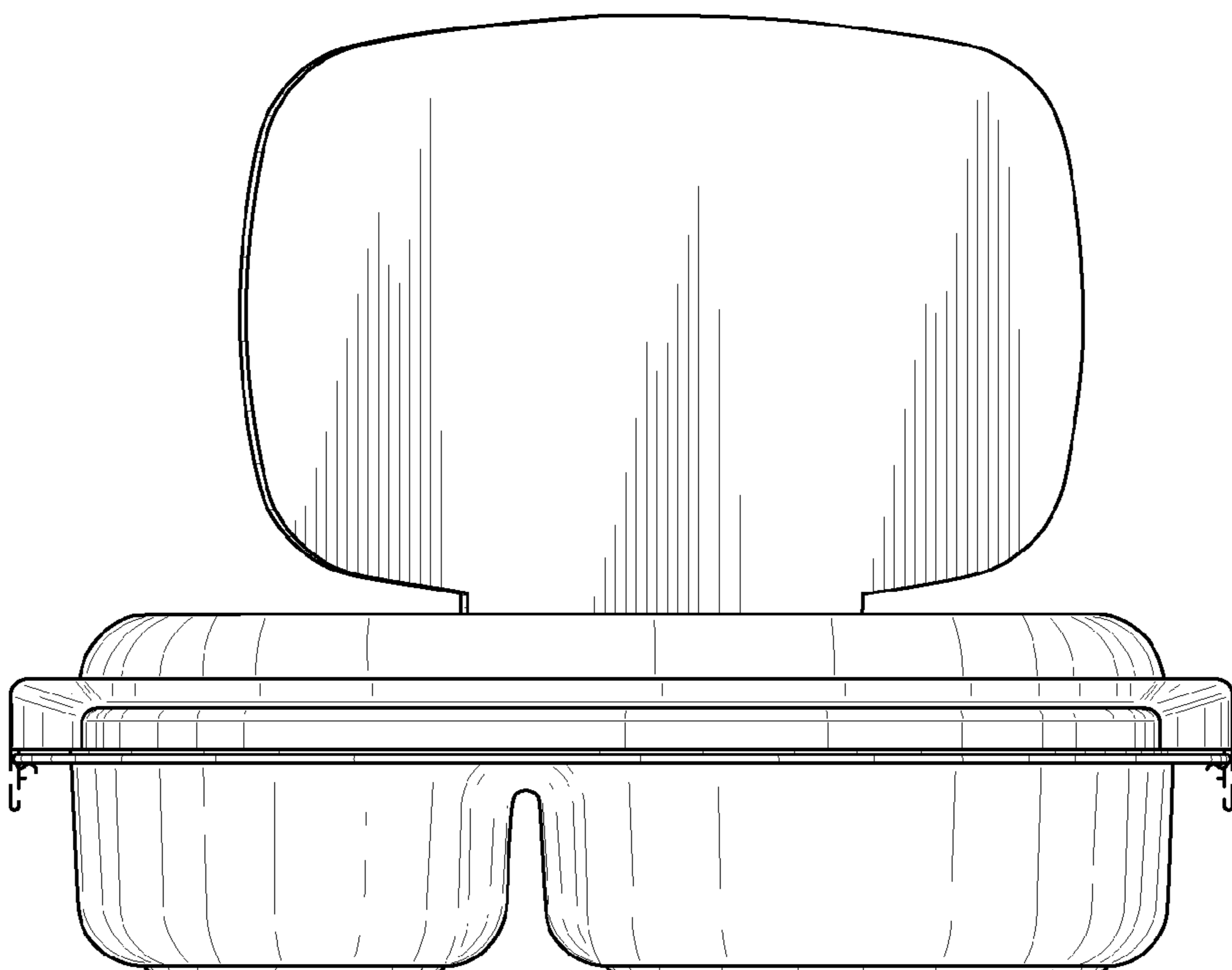

FIG. 12

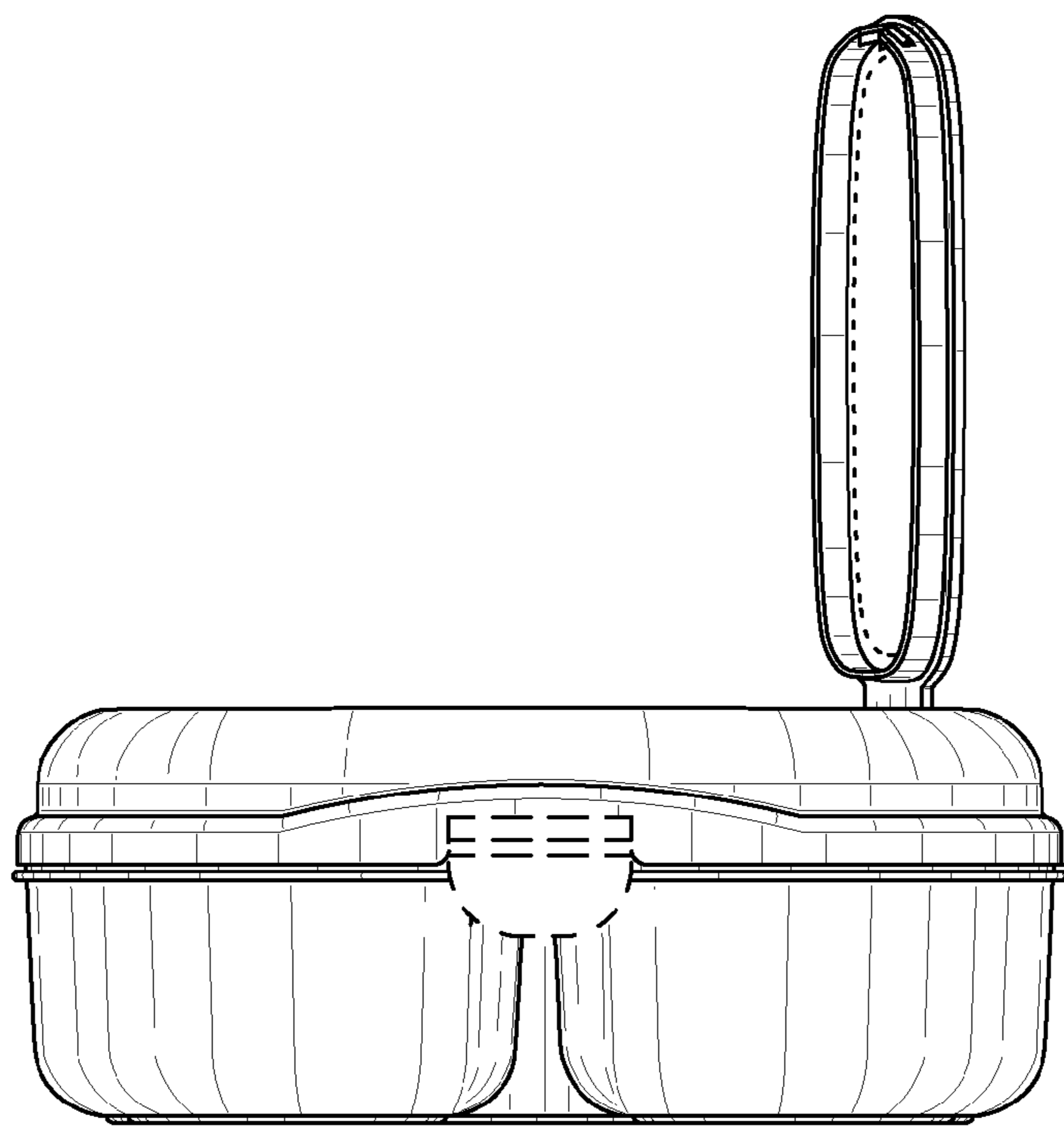

FIG. 13

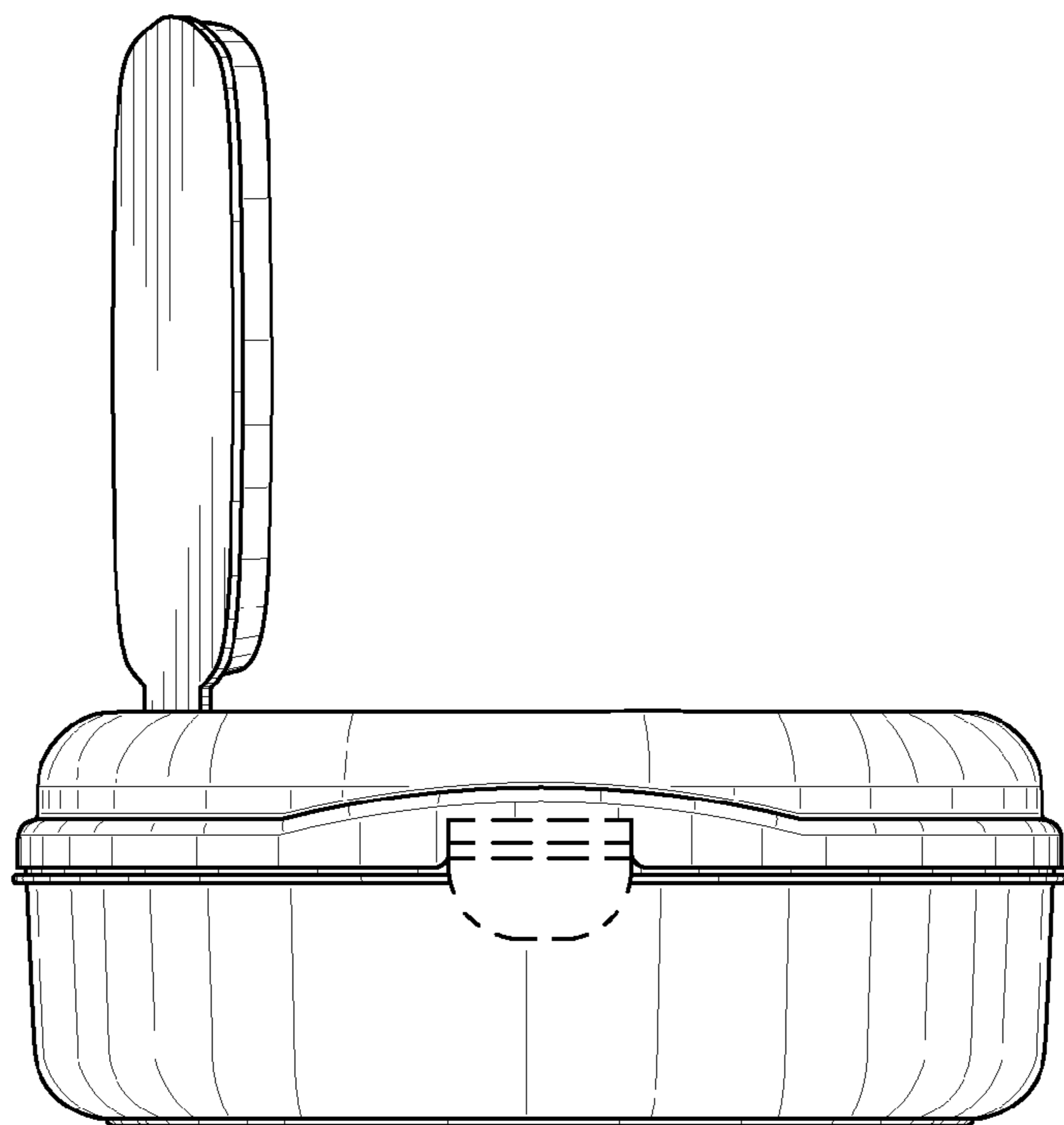

FIG. 14