



US00D618495S

(12) **United States Design Patent**  
**Welk et al.**

(10) **Patent No.:** **US D618,495 S**  
(45) **Date of Patent:** **\*\* Jun. 29, 2010**

(54) **COOKING VESSEL**

(75) Inventors: **Michael Welk**, Vernon Hills, IL (US);  
**Tara Marie Marchionna**, New York,  
NY (US); **Paul Katz**, New York, NY  
(US); **Kirsten Jane Climer**, New York,  
NY (US); **Diana Beatriz Sierra**, North  
Bergen, NJ (US); **Bikramjeet Sohi**,  
Buffalo Grove, IL (US); **John Chap**,  
Woodridge, IL (US); **Davin Stowell**,  
New York, NY (US)

(73) Assignee: **WKI Holding Company, Inc.**,  
Rosemont, IL (US)

(\*\*) Term: **14 Years**

(21) Appl. No.: **29/345,757**

(22) Filed: **Oct. 22, 2009**

(51) **LOC (9) Cl.** ..... **07-02**

(52) **U.S. Cl.** ..... **D7/361; D7/354**

(58) **Field of Classification Search** ..... D7/323,  
D7/330-331, 339, 347, 350-367, 378-379,  
D7/383-387, 391-395, 538-545, 667; D10/46.2;  
99/324-325, 329 R, 330-339, 400-403, 412-413,  
99/425, 448, 451; 210/467; 211/96; 219/432-433,  
219/438-441, 620-622, 725-730; 220/203.1,  
220/203.07, 203.09, 298, 303, 316, 356.1,  
220/366.1, 573.1-574, 755, 769-771, 912;  
222/572

See application file for complete search history.

(56) **References Cited**

**U.S. PATENT DOCUMENTS**

2,561,806 A \* 7/1951 Mailland ..... 211/96  
D233,928 S \* 12/1974 Sams ..... D7/361  
D237,133 S \* 10/1975 Cyren ..... D7/361  
4,310,418 A \* 1/1982 Busbey ..... 210/467  
D327,609 S \* 7/1992 Carlson ..... D7/667  
D328,996 S \* 9/1992 Gerlach ..... D7/361  
D328,997 S \* 9/1992 Gerlach ..... D7/361  
D330,863 S \* 11/1992 Green ..... D10/46.2

D347,141 S \* 5/1994 Maillard ..... D7/361  
5,388,732 A \* 2/1995 Greger ..... 222/572  
D386,940 S \* 12/1997 Hess ..... D7/361  
5,730,045 A \* 3/1998 Delaquis et al. .... 99/337  
6,035,766 A \* 3/2000 Schirmer ..... 99/403  
D455,315 S \* 4/2002 Cheng ..... D7/354  
D455,599 S \* 4/2002 Cheng ..... D7/354  
D482,562 S \* 11/2003 Demers ..... D7/354  
D552,925 S \* 10/2007 Kloppsteck ..... D7/361  
D571,607 S \* 6/2008 Stattmann ..... D7/361

(Continued)

*Primary Examiner*—Caron Veynar

*Assistant Examiner*—Ricky Pham

(74) *Attorney, Agent, or Firm*—McDermott Will & Emery  
LLP

(57) **CLAIM**

We claim the ornamental design for a cooking vessel, as  
shown and described.

**DESCRIPTION**

FIG. 1 is a perspective view of a cooking vessel according to  
the new design;

FIG. 2 is a front view of the cooking vessel shown in FIG. 1;

FIG. 3 is a rear view of the cooking vessel shown in FIG. 1;

FIG. 4 is a top view of the cooking vessel shown in FIG. 1;

FIG. 5 is a bottom view of the cooking vessel shown in FIG.  
1;

FIG. 6 is a left side elevation view of the cooking vessel  
shown in FIG. 1; and,

FIG. 7 is a right side elevation view of the cooking vessel  
shown in FIG. 1.

**1 Claim, 5 Drawing Sheets**

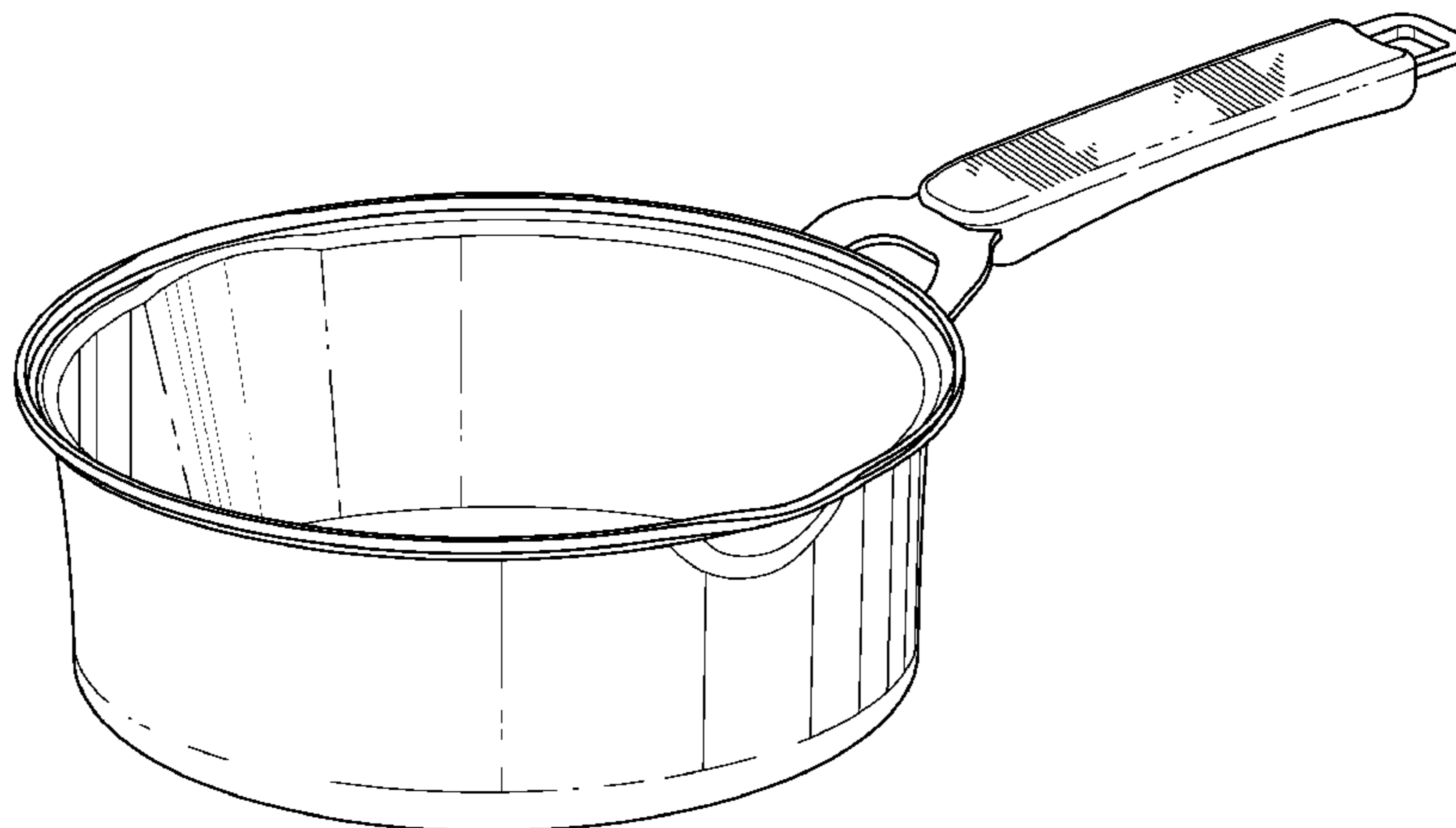

# US D618,495 S

Page 2

---

## U.S. PATENT DOCUMENTS

D572,077 S *	7/2008	Duke	.....	D7/387	
D579,716 S *	11/2008	Pawson et al.	.....	D7/361	
D588,861 S *	3/2009	Cheng	.....	D7/361	* cited by examiner
D596,451 S *	7/2009	Wu	.....	D7/361	
D603,211 S *	11/2009	Ek	.....	D7/354	

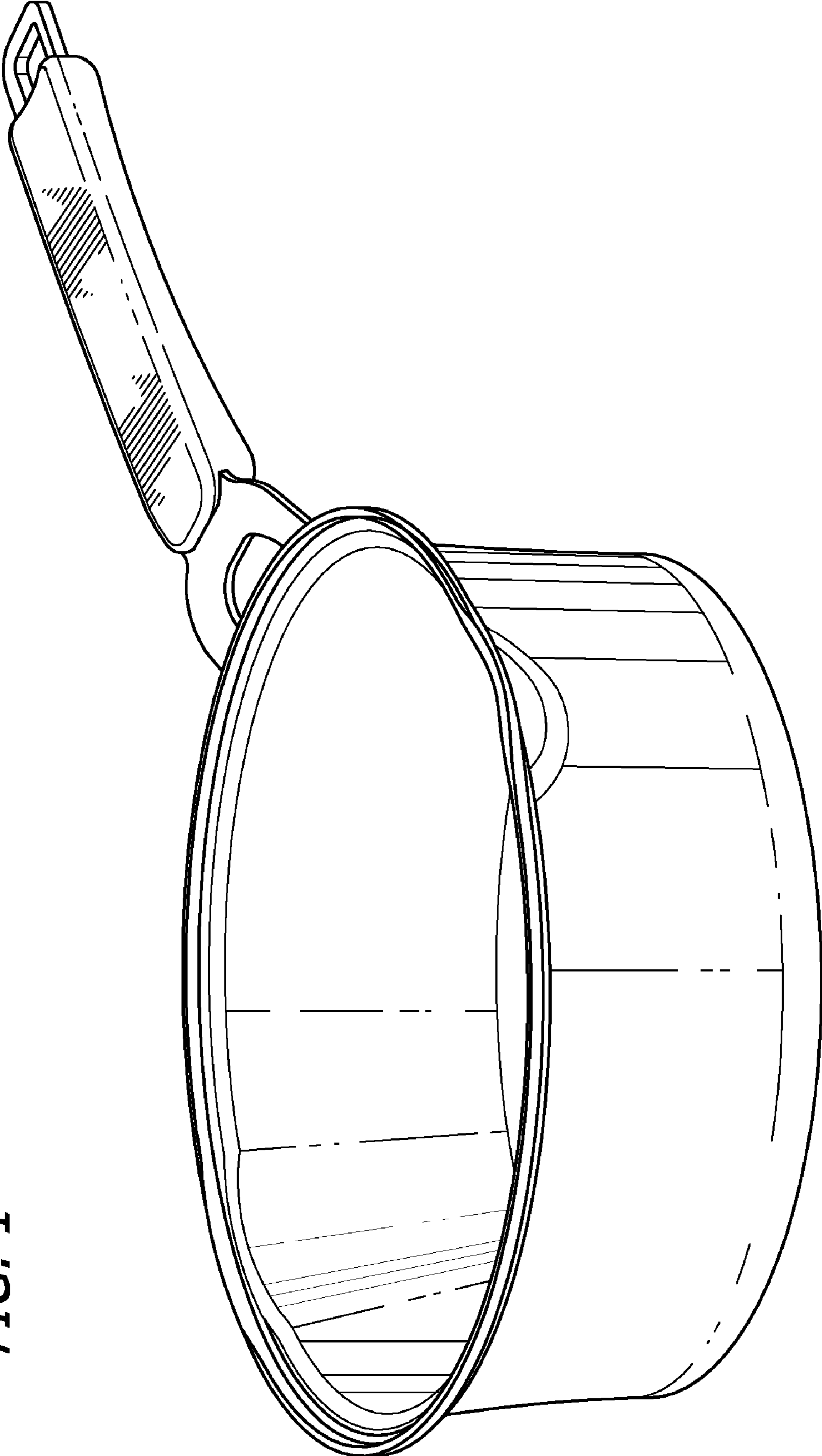

**FIG. 1**

FIG. 2

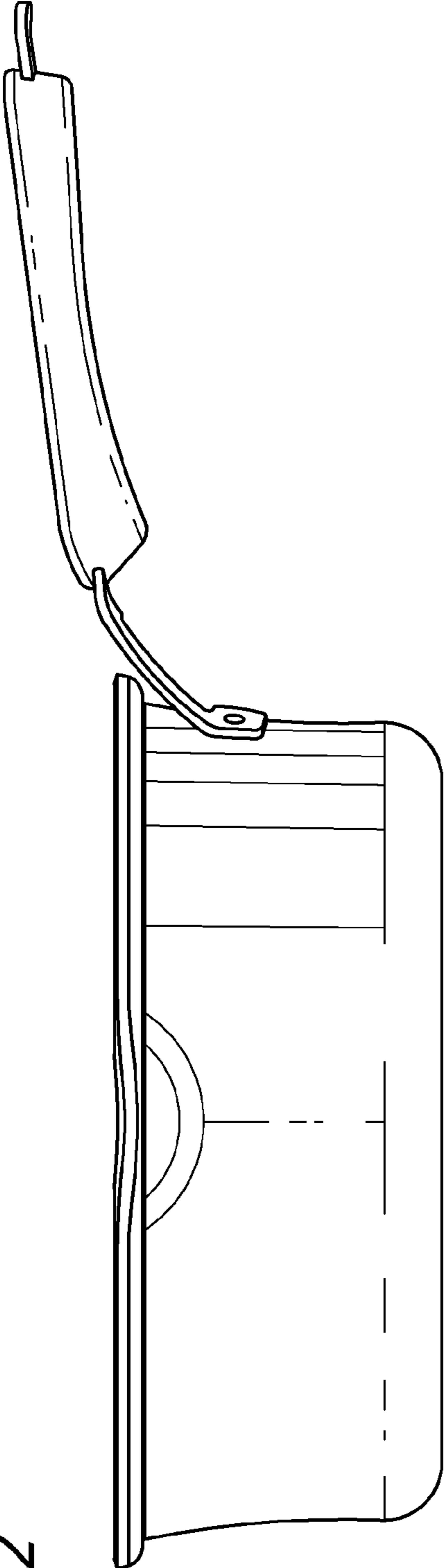
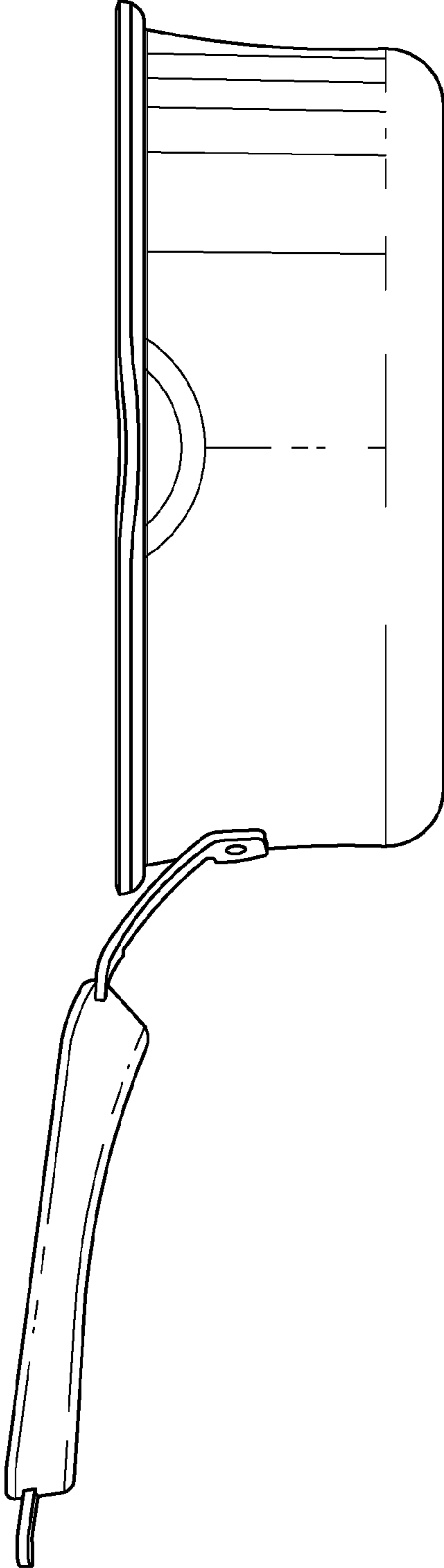

FIG. 3



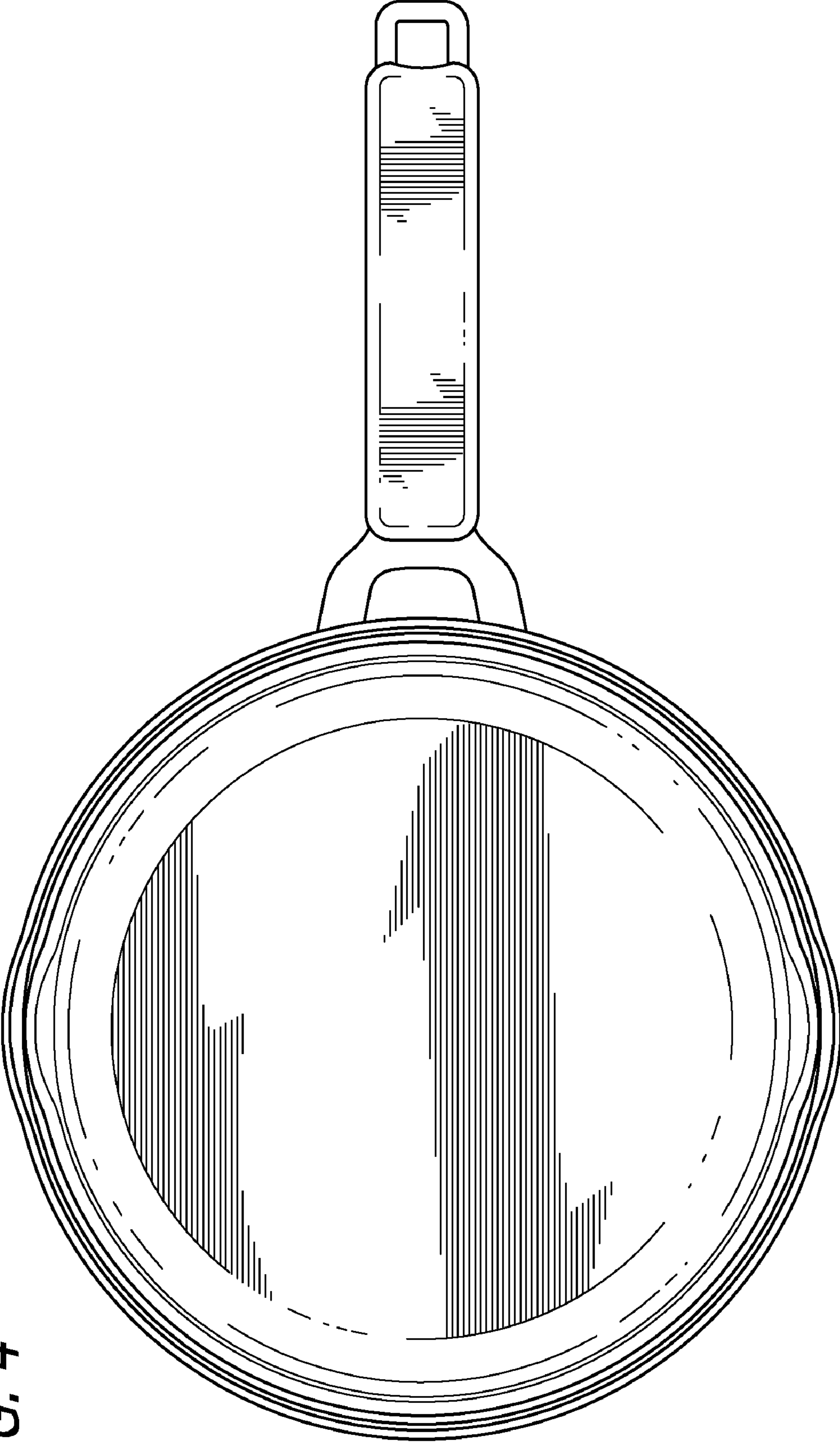

FIG. 4

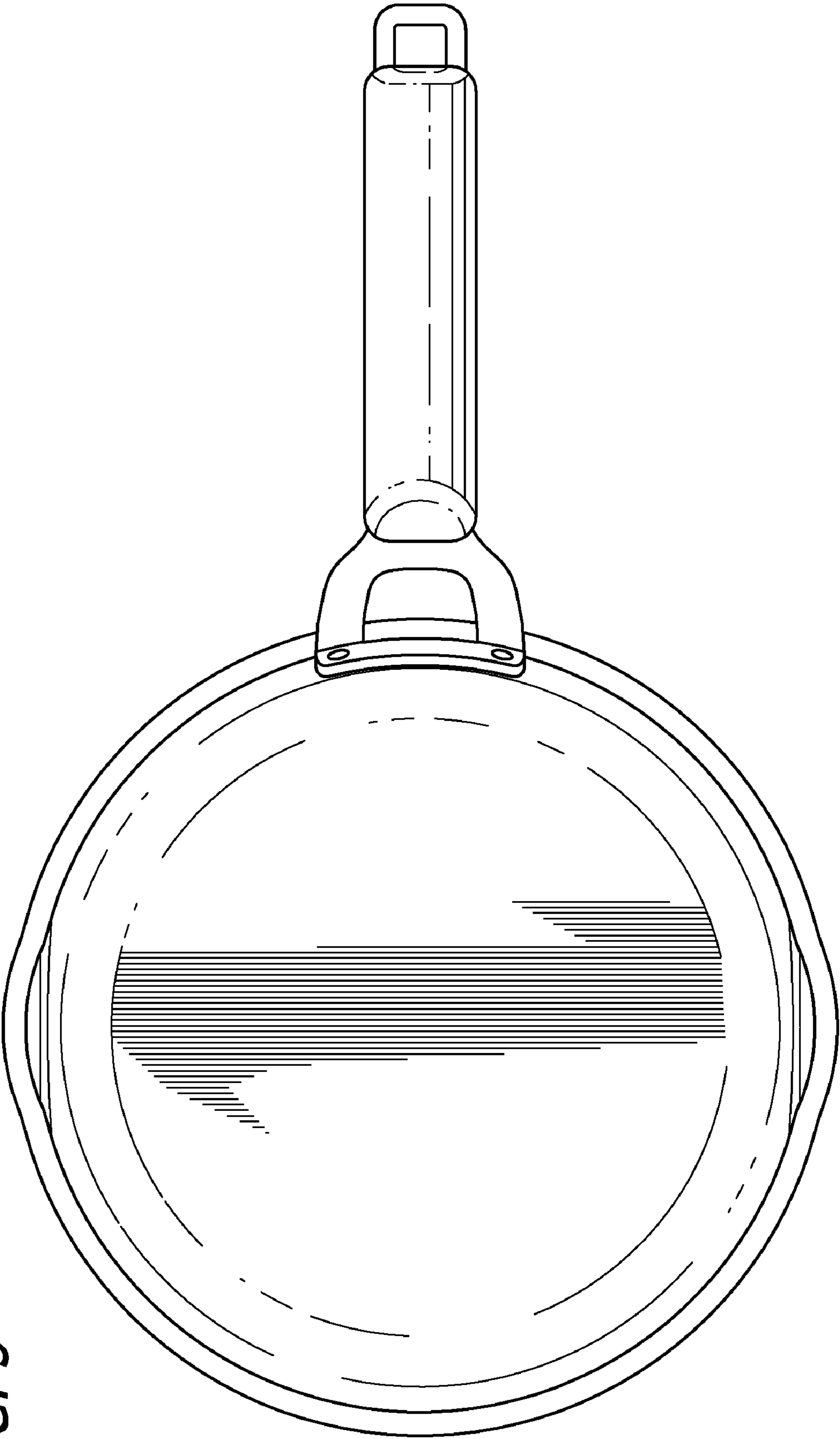
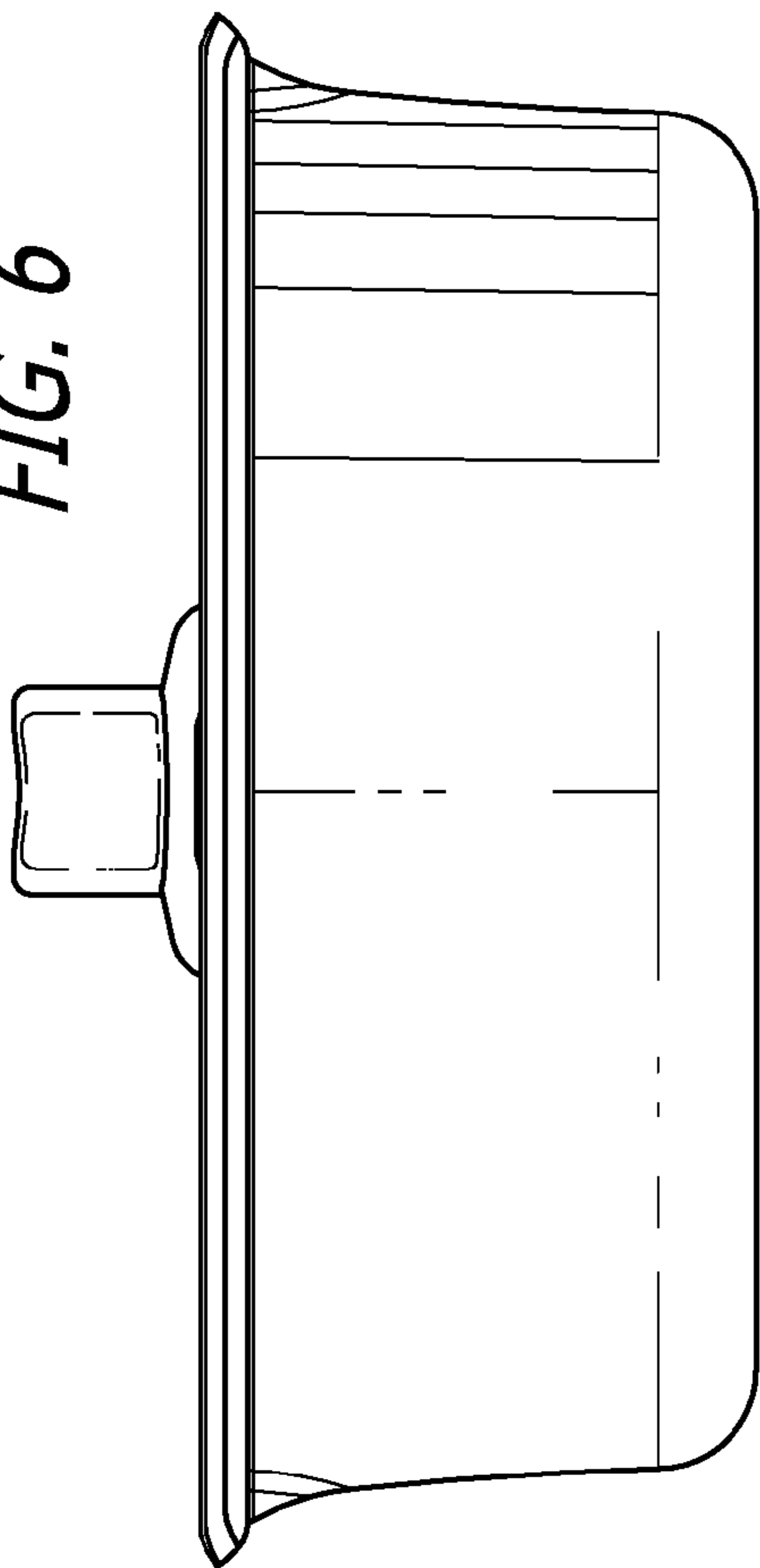

FIG. 5

*FIG. 6*



*FIG. 7*

