



US00D618301S

(12) **United States Design Patent**  
**Cho**

(10) **Patent No.:** **US D618,301 S**

(45) **Date of Patent:** **\*\* Jun. 22, 2010**

(54) **ION WATER PURIFIER**

D596,702 S \* 7/2009 Chen ..... D23/207

(76) Inventor: **Gyu-Dai Cho**, 1145-14, Sanbon-dong,  
Gunpo-si, Gyeonggi-do 435-040 (KR)

\* cited by examiner

*Primary Examiner*—Robin V Webster

(74) *Attorney, Agent, or Firm*—F. Chau & Associates, LLC

(\*\*) Term: **14 Years**

(21) Appl. No.: **29/343,040**

(57) **CLAIM**

(22) Filed: **Sep. 4, 2009**

The ornamental design for ion water purifier, as shown and described.

(51) **LOC (9) Cl.** ..... **23-01**

(52) **U.S. Cl.** ..... **D23/207**

(58) **Field of Classification Search** ..... D23/207,  
D23/209; 210/435, 241, 190, 243  
See application file for complete search history.

**DESCRIPTION**

FIG. 1 is a perspective view showing an ion water purifier having the design of the invention;

FIG. 2 is a front view of the ion water purifier;

FIG. 3 is a rear view of the ion water purifier;

FIG. 4 is a left side view of the ion water purifier;

FIG. 5 is a right side view of the ion water purifier;

FIG. 6 is a top view of the ion water purifier; and,

FIG. 7 is a bottom view of the ion water purifier.

(56) **References Cited**

U.S. PATENT DOCUMENTS

D295,656 S *	5/1988	Bond et al.	.....	D23/207
D453,951 S *	2/2002	Kim	.....	D23/207
D485,330 S *	1/2004	Shyu	.....	D23/207
D504,935 S *	5/2005	Taneike et al.	.....	D23/207
D590,044 S *	4/2009	Cho	.....	D23/207

**1 Claim, 7 Drawing Sheets**

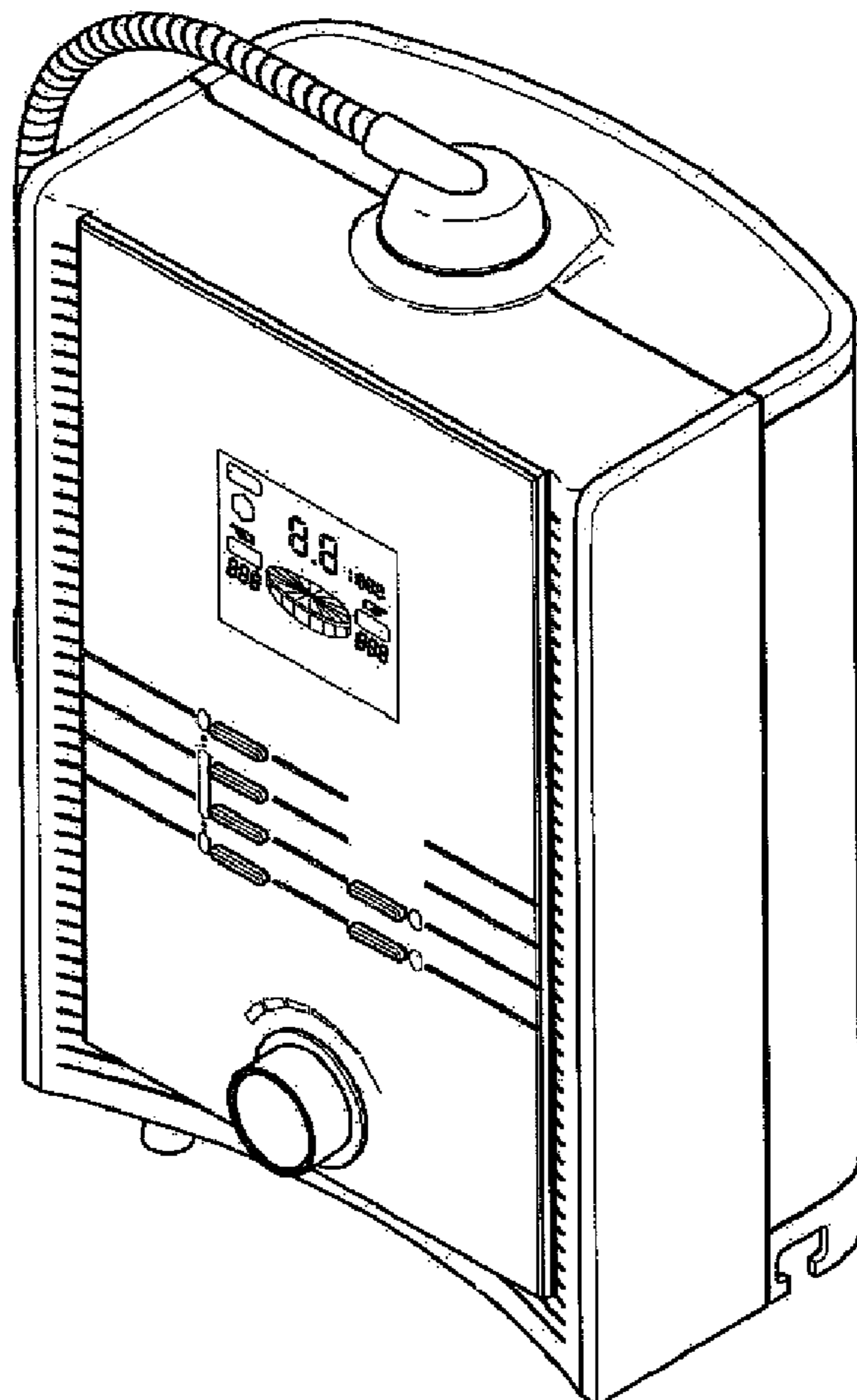

FIG. 1

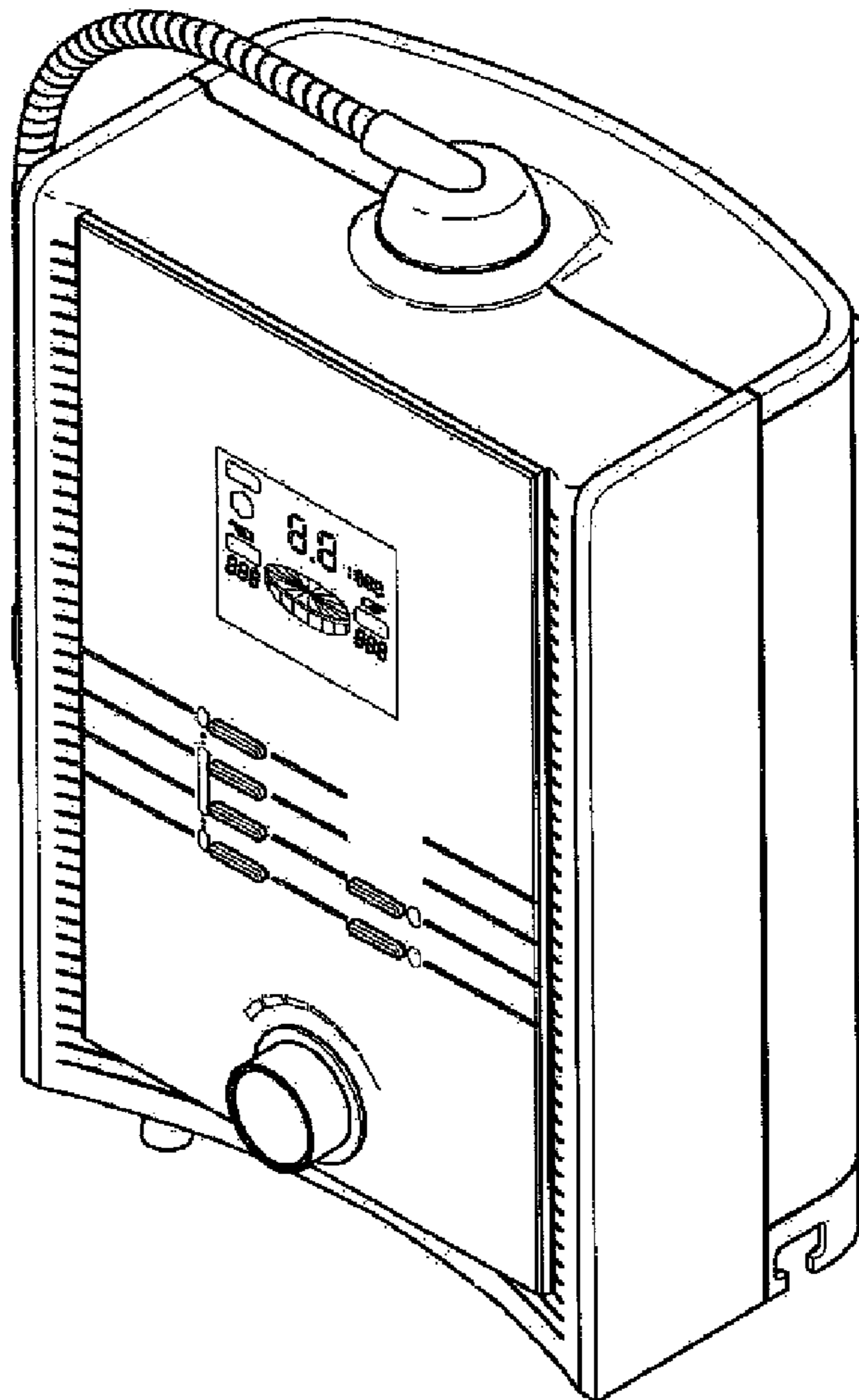

FIG. 2

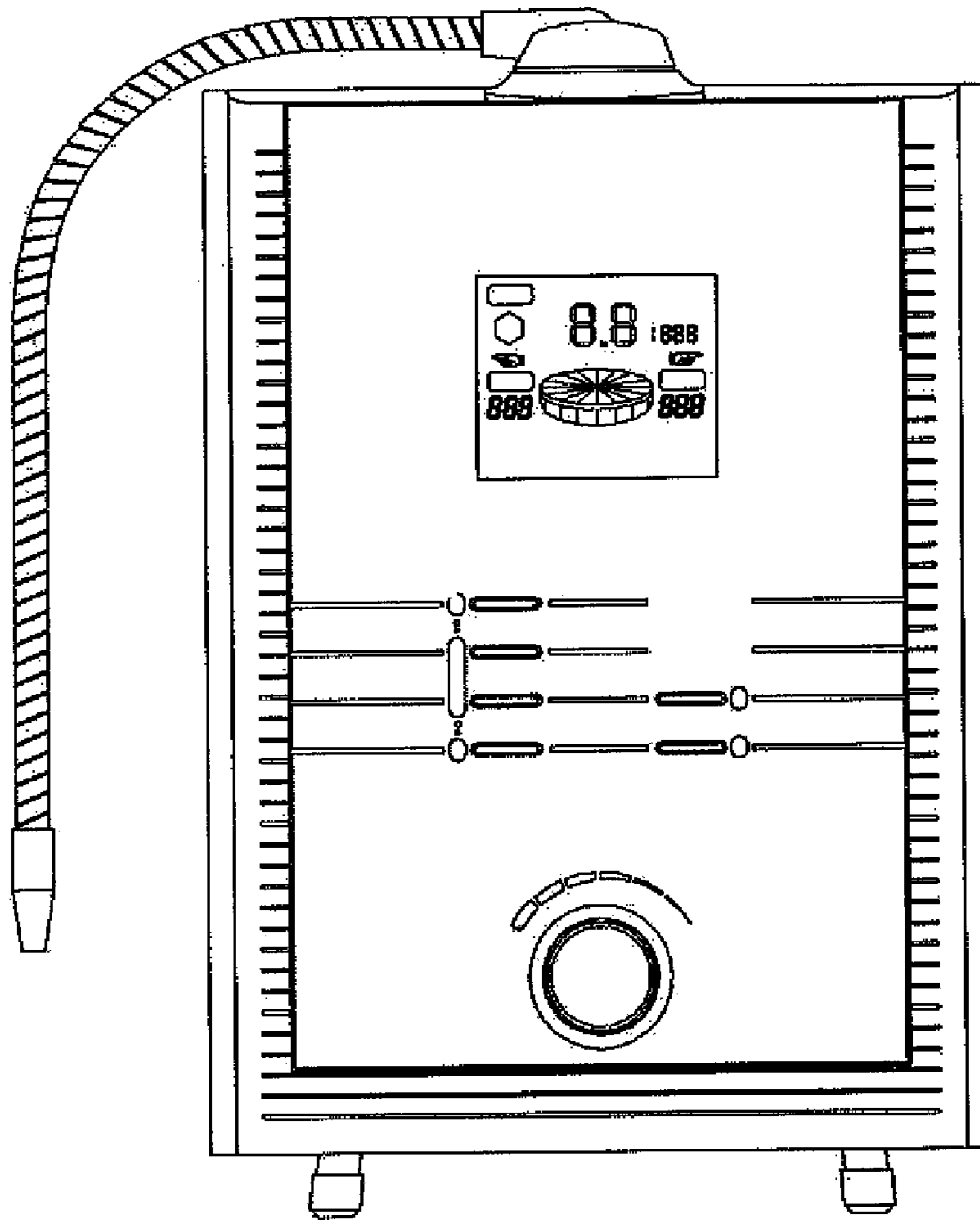

FIG.3

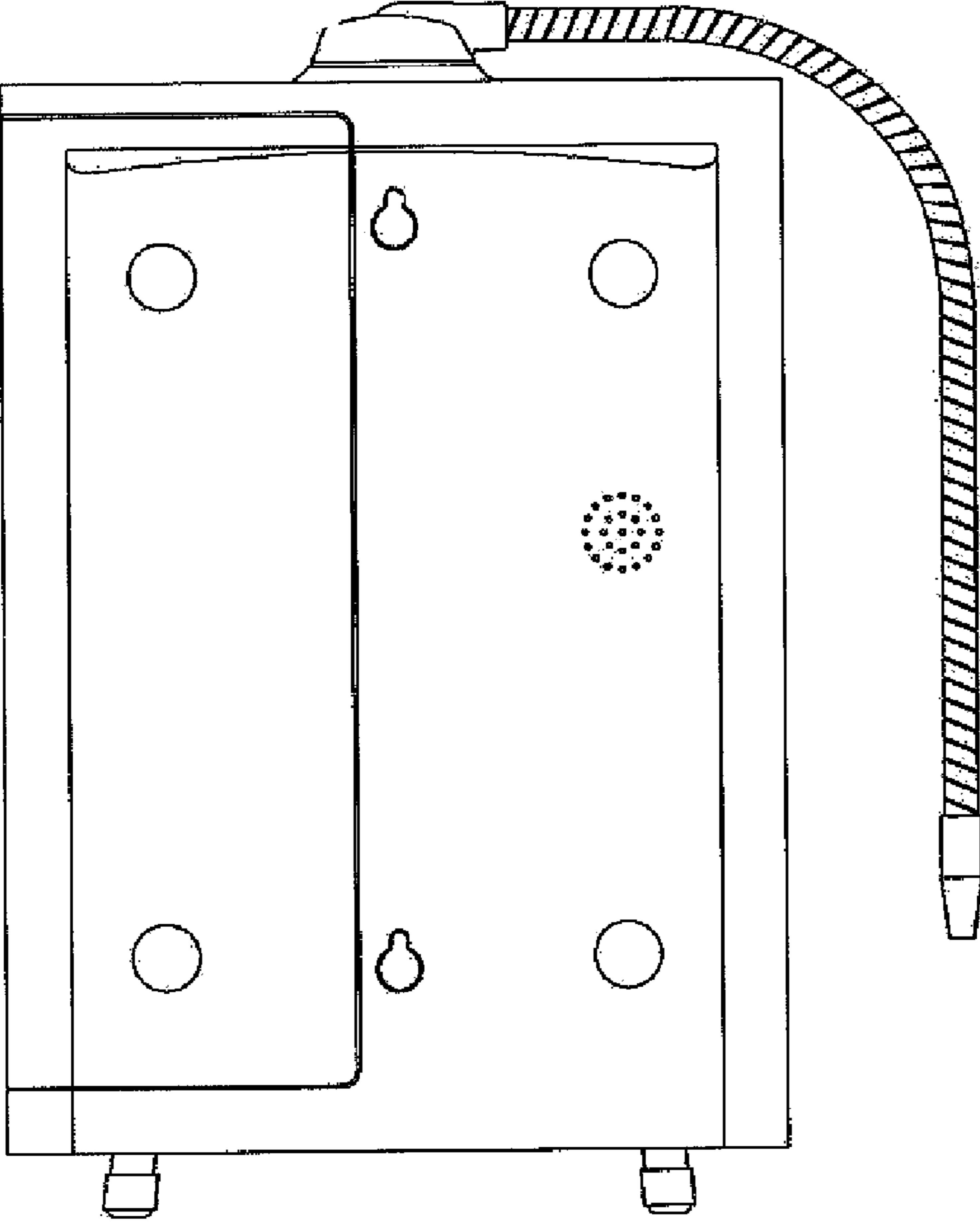

FIG. 4

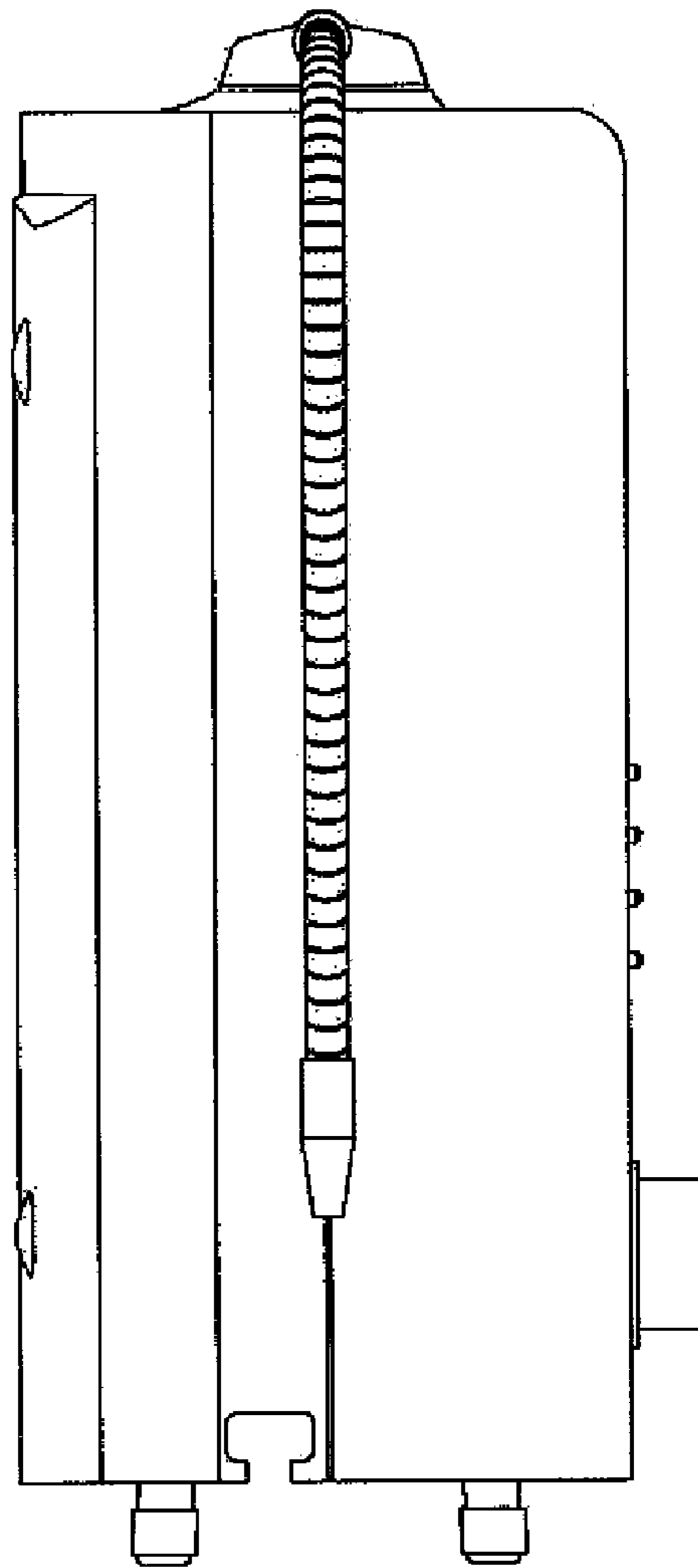

FIG. 5

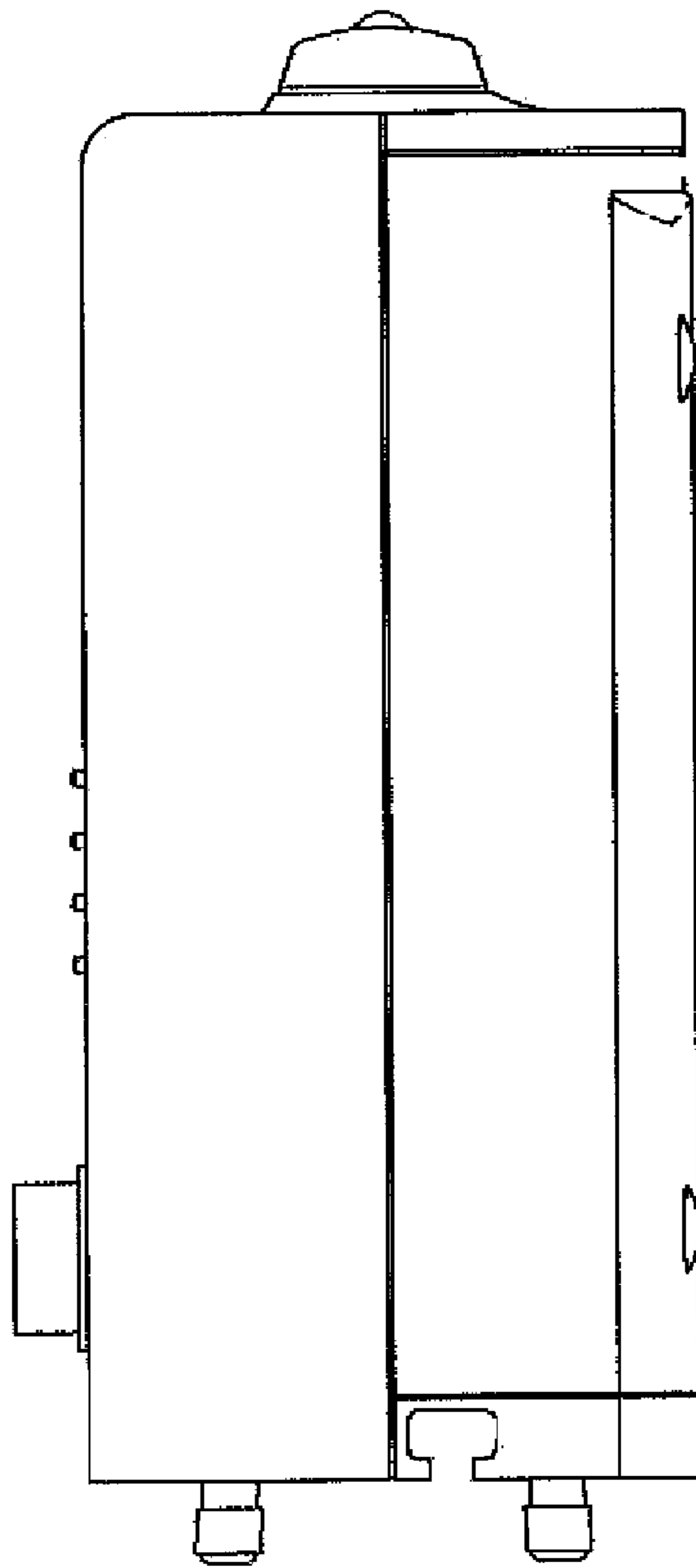

FIG. 6

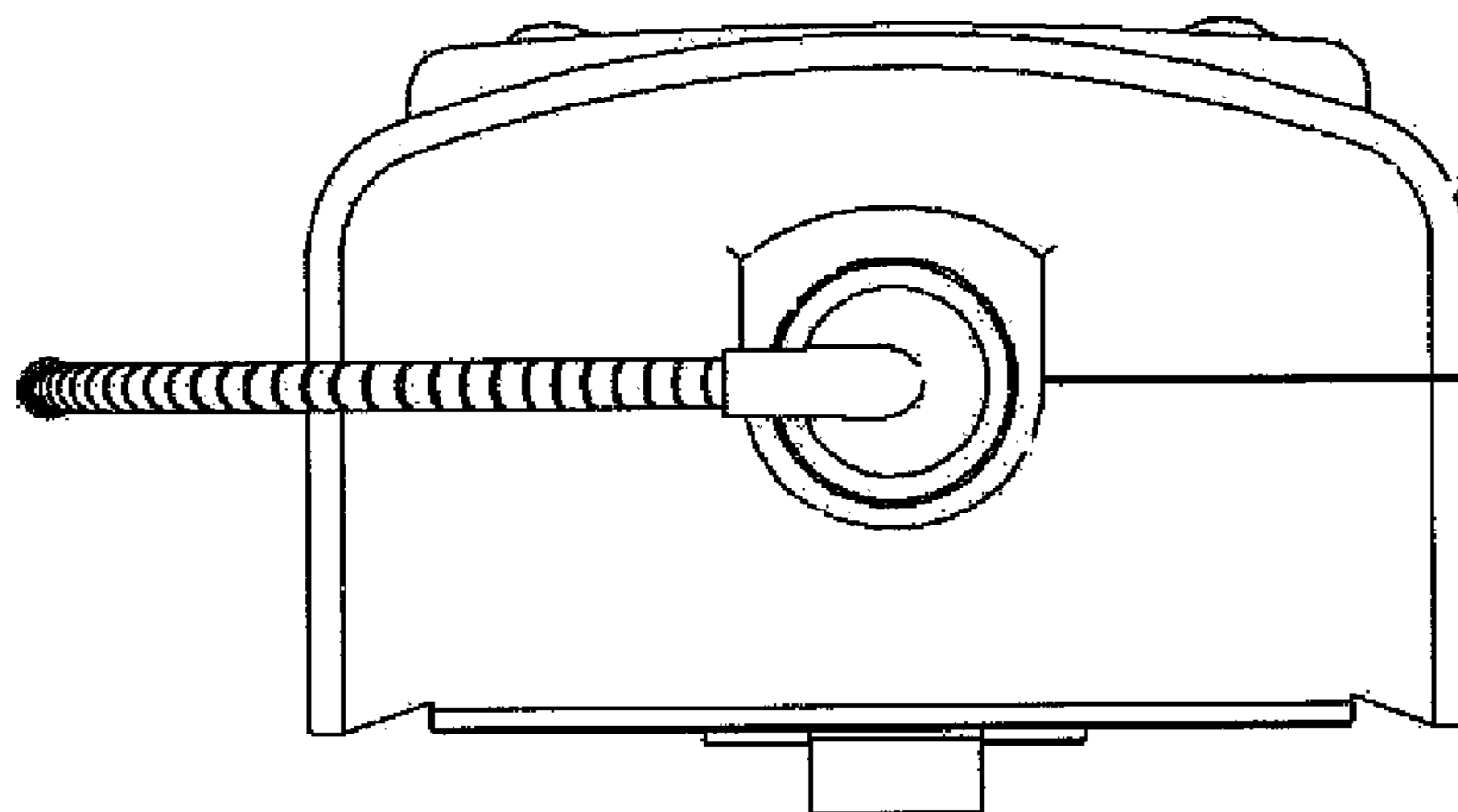

FIG. 7

