



US00D618135S

(12) **United States Design Patent**
Horst

(10) **Patent No.:** **US D618,135 S**
(45) **Date of Patent:** **** Jun. 22, 2010**

(54) **CROSS**

(76) Inventor: **Elisa Horst**, 5312 48th Ter. North, St.
Petersburg, FL (US) 33709

(**) Term: **14 Years**

(21) Appl. No.: **29/350,584**

(22) Filed: **Nov. 19, 2009**

(51) **LOC (9) Cl.** **11-02**

(52) **U.S. Cl.** **D11/157; D99/23**

(58) **Field of Classification Search** D11/81,
D11/96, 122, 125, 131, 157, 160-161, 163;
D99/17, 25-27; D19/96-97; D20/41; 235/123;
428/3; 434/246; 312/33; 40/409-410; 248/346.03,
248/473; 206/19

See application file for complete search history.

(56) **References Cited**

U.S. PATENT DOCUMENTS

- 1,391,945 A 9/1921 Flagge
- 1,524,835 A 2/1925 Mattern et al.
- D67,289 S * 5/1925 Ladewich D99/23
- 2,036,616 A 4/1936 Asch
- D133,983 S * 10/1942 Cruise et al. D11/157
- 2,325,883 A 8/1943 Schleif
- 2,355,154 A * 8/1944 Goudreau 428/3
- 3,992,812 A 11/1976 Horowitz
- D256,398 S * 8/1980 Mitchell D99/25

- 4,453,201 A 6/1984 Prouty
- 5,255,170 A 10/1993 Plamp et al.
- D365,781 S * 1/1996 Osborn D11/96
- 5,564,816 A 10/1996 Arcadia et al.
- 6,364,593 B1 4/2002 Hofmeister et al.
- D508,580 S 8/2005 Norris et al.
- D563,828 S * 3/2008 Meijer D11/163
- D578,275 S * 10/2008 Shantz et al. D99/17
- D589,225 S * 3/2009 Wilburn D99/25
- D590,574 S * 4/2009 Pawlik D99/27

* cited by examiner

Primary Examiner—T. Chase Nelson
Assistant Examiner—Michelle E Wilson
(74) *Attorney, Agent, or Firm*—Kyle Fletcher

(57) **CLAIM**

The ornamental design for the cross, as shown and described.

DESCRIPTION

FIG. 1 is a front view of the cross with the following words
“Walk in light, as he is in the light” 1 John 1:7.

FIG. 2 is a rear view of the claimed design.

FIG. 3 is a left view of the claimed design.

FIG. 4 is a top view of the claimed design.

FIG. 5 is a bottom view of the claimed design; and,

FIG. 6 is an isometric view of the claimed design.

1 Claim, 5 Drawing Sheets

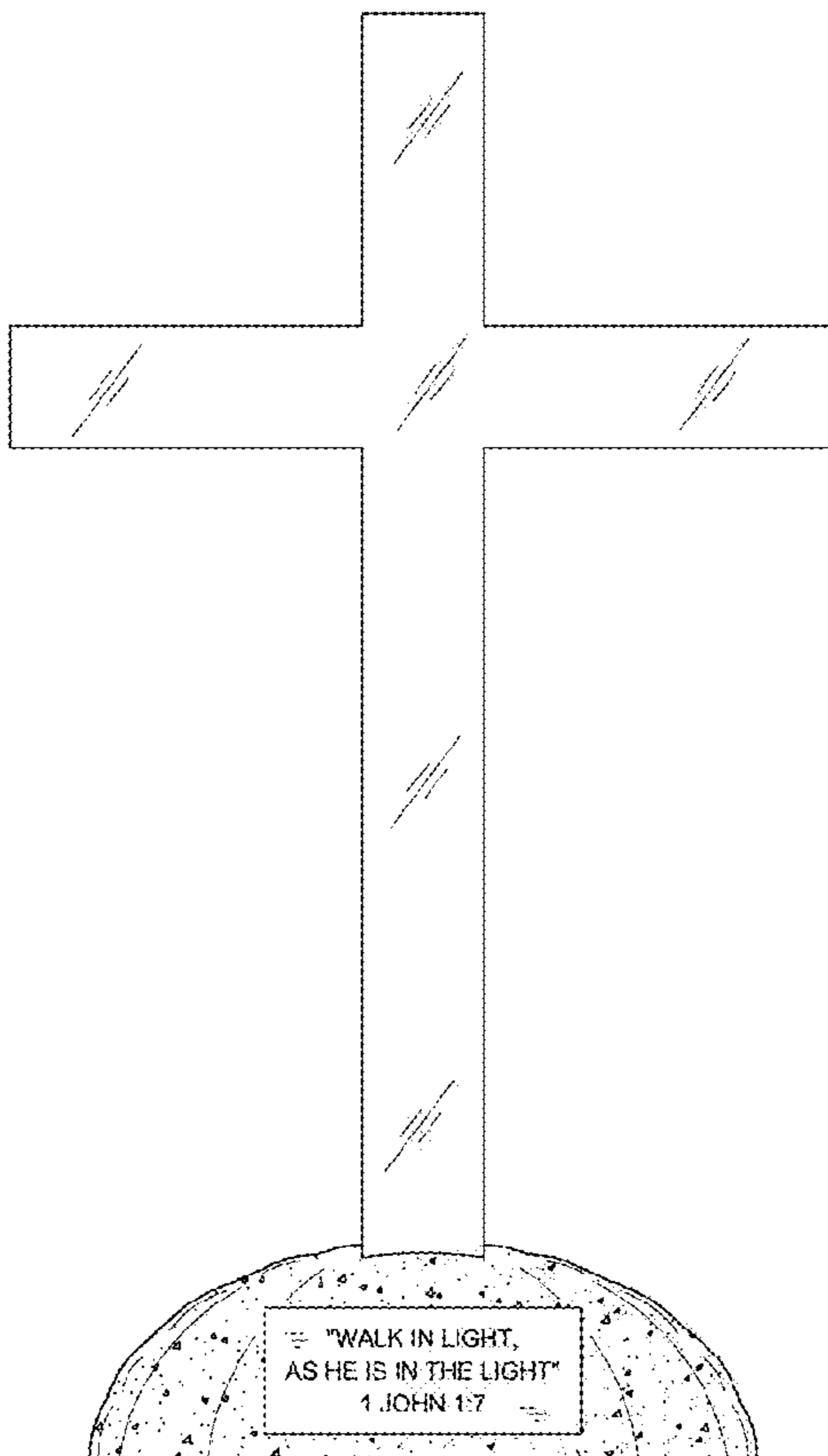

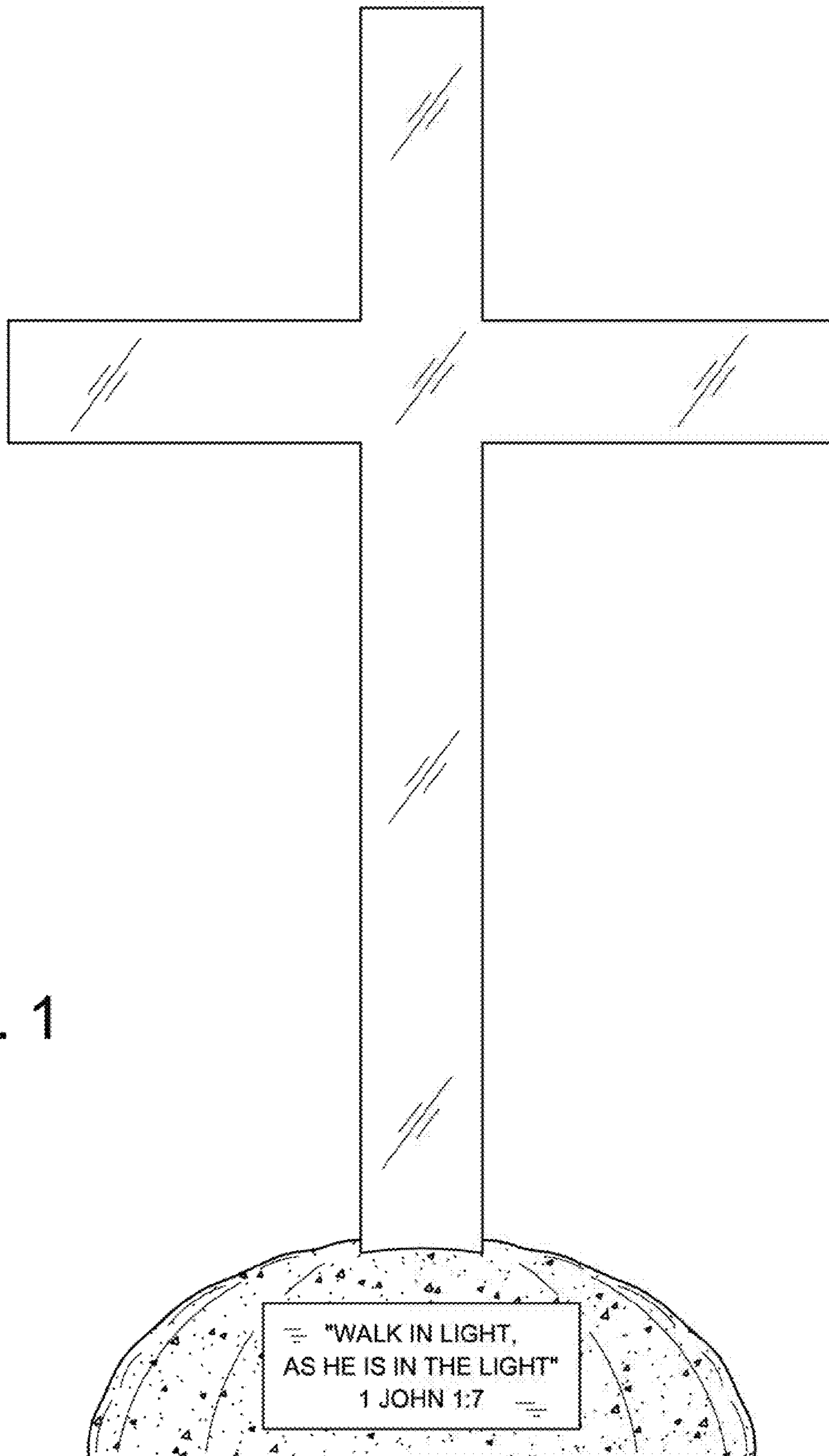

FIG. 1

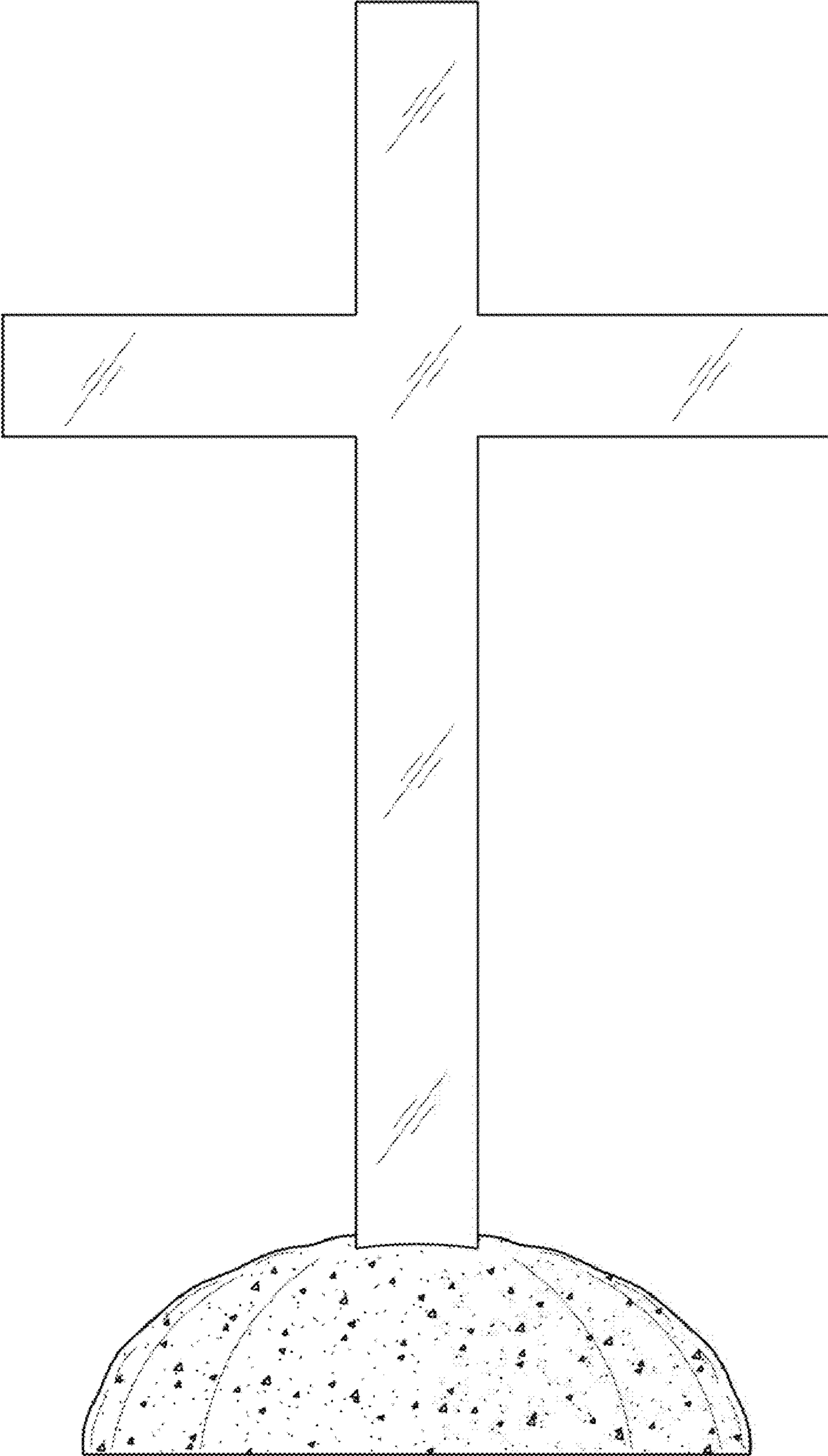

FIG. 2

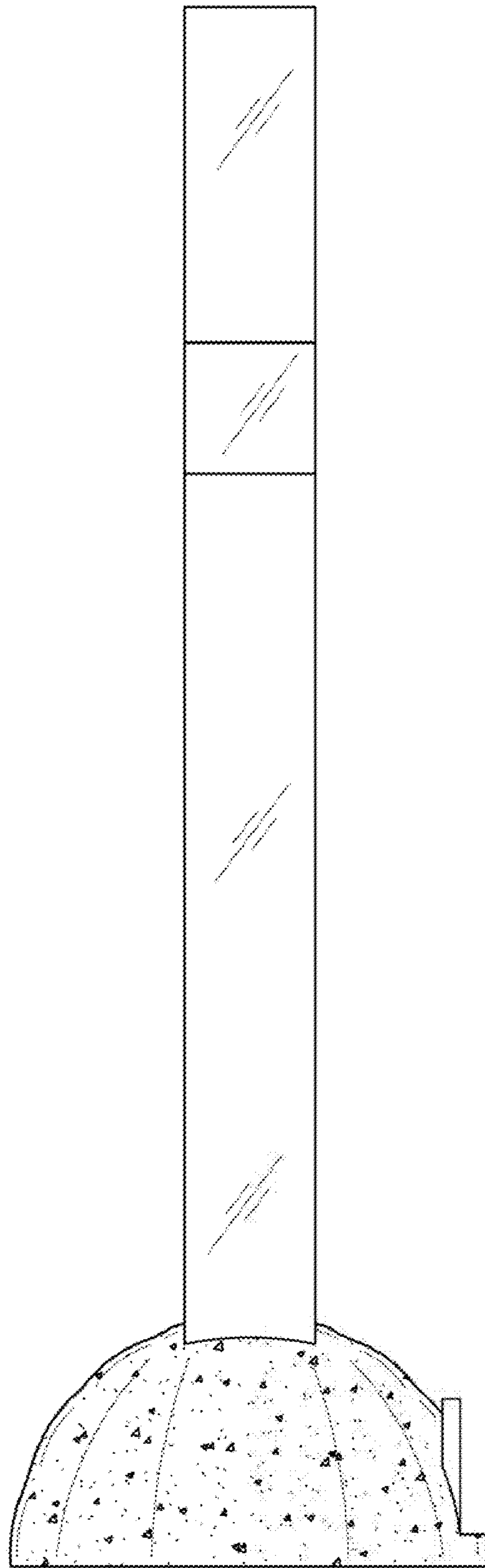

FIG. 3

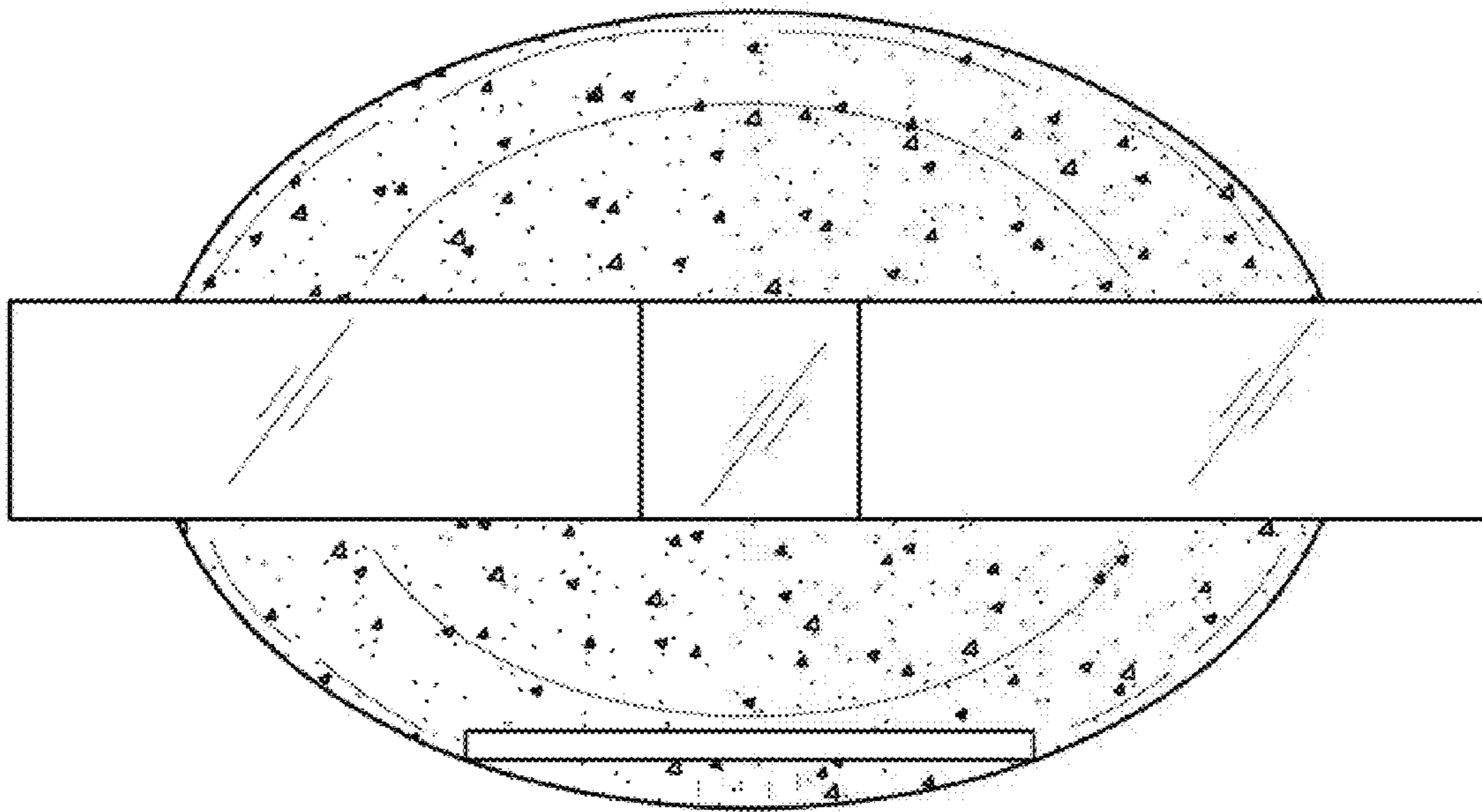

FIG. 4

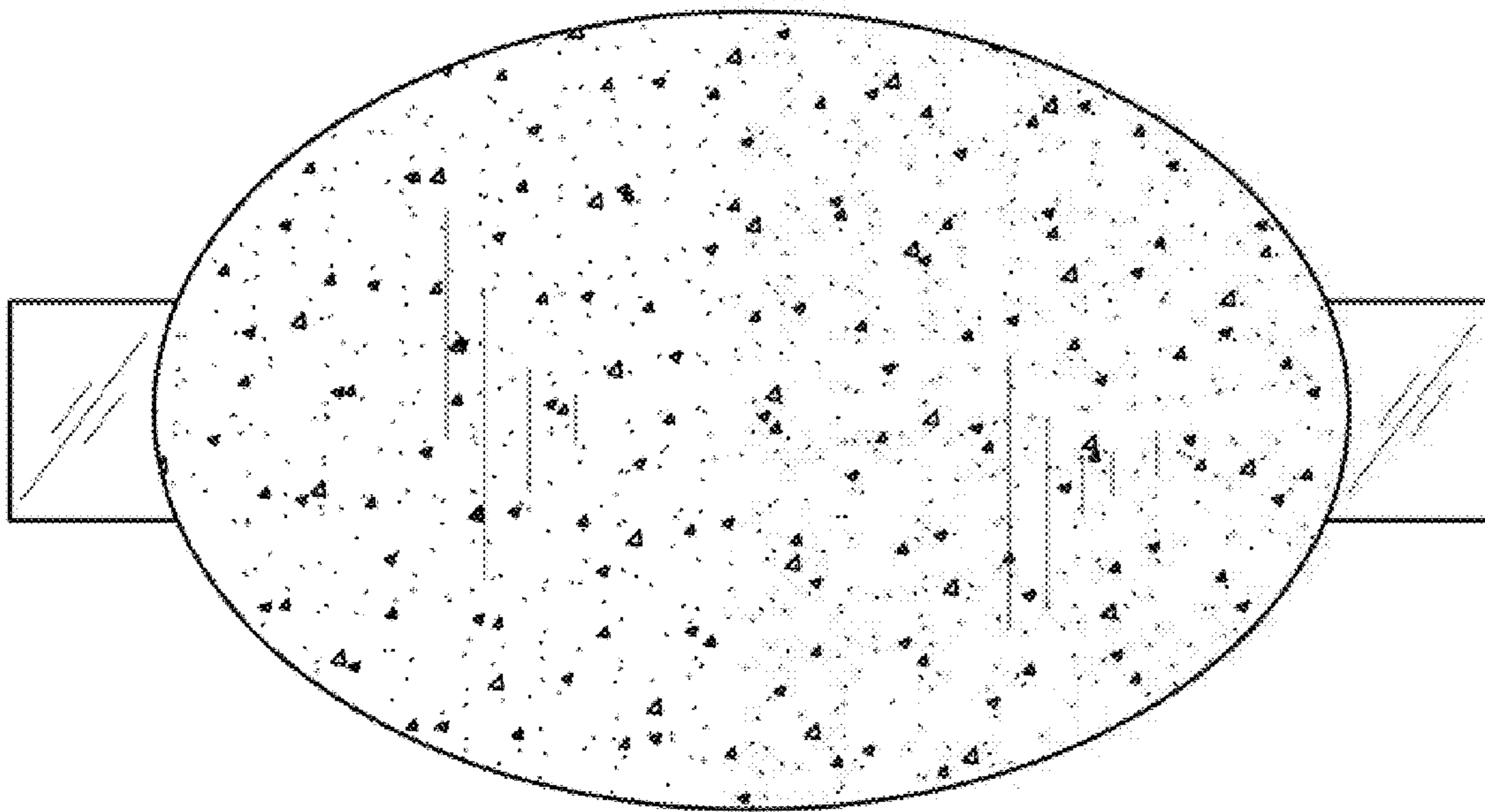

FIG. 5

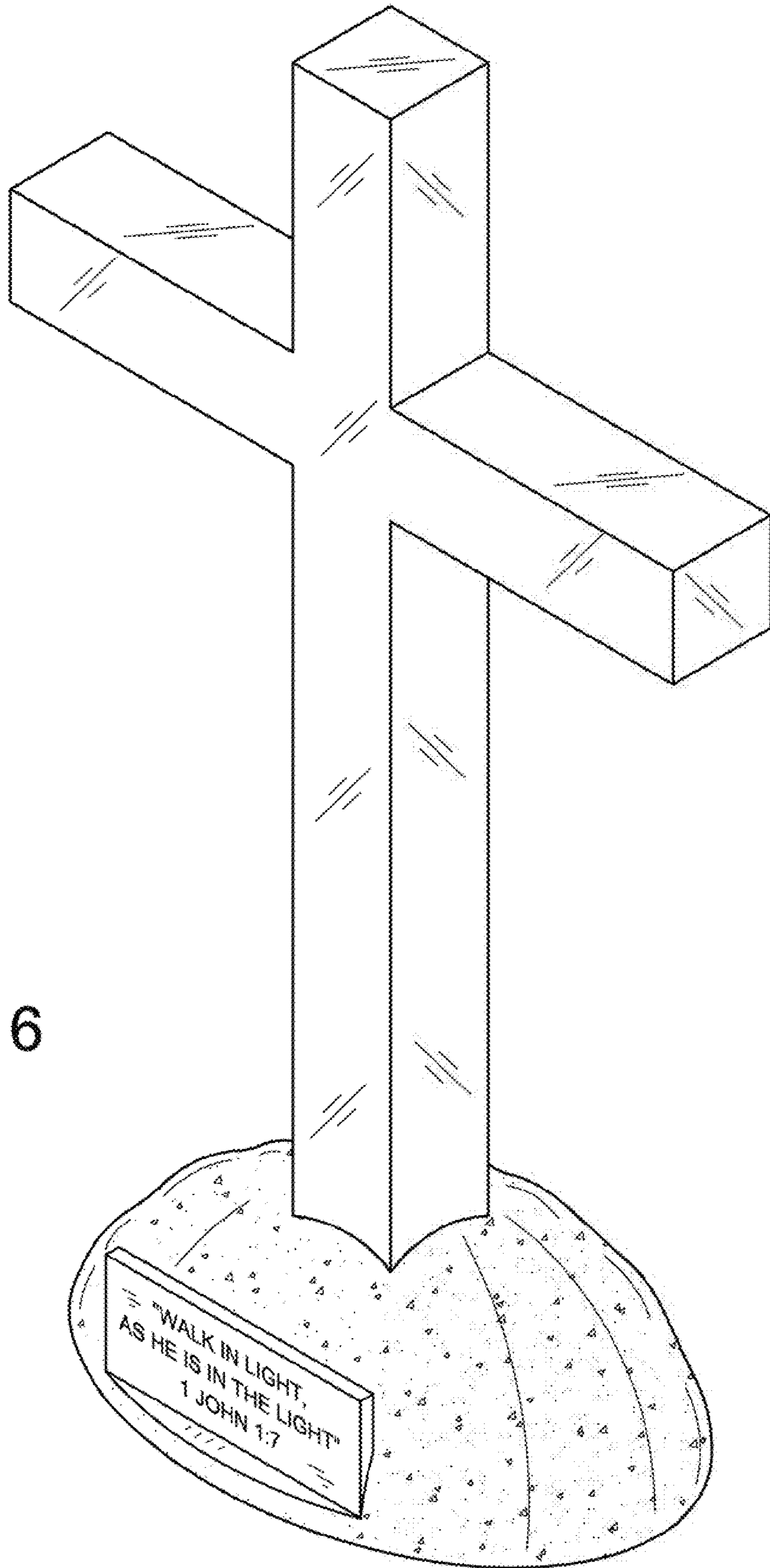

FIG. 6