



US00D618101S

(12) **United States Design Patent**
Schmitz

(10) **Patent No.:** **US D618,101 S**
(45) **Date of Patent:** **** Jun. 22, 2010**

(54) **BOTTLE CAP**

Primary Examiner—Susan Bennett Hattan

(76) Inventor: **Guido Schmitz**, 654 W. Mountain Ave.,
Sparta, NJ (US) 07871

(57) **CLAIM**

(**) Term: **14 Years**

The ornamental design for a bottle cap, as shown and described.

(21) Appl. No.: **29/348,862**

(22) Filed: **Feb. 16, 2010**

DESCRIPTION

(51) **LOC (9) Cl.** **09-07**

(52) **U.S. Cl.** **D9/454**

(58) **Field of Classification Search** D9/529,
D9/521, 454, 452, 447, 445, 435, 453, 530,
D9/724, 448, 538, 438; 220/200, 806, 716,
220/258.2, 257.1; 215/200, 261, 260; 222/520,
222/521, 212

See application file for complete search history.

FIG. 1 is an illustrative view of the bottle cap of the invention;
FIG. 2 is a front elevational view thereof;
FIG. 3 is a side elevational view thereof;
FIG. 4 is a top view thereof;
FIG. 5 is an illustrative view of the bottle cap of the invention
in an alternative embodiment;
FIG. 6 is a front elevational view of the alternative embodi-
ment;
FIG. 7 is a side elevational view of the alternative embodi-
ment; and,
FIG. 8 is a top view of the alternative environment.

(56) **References Cited**

U.S. PATENT DOCUMENTS

D461,718 S *	8/2002	Brozell	D9/529
D489,257 S *	5/2004	Braaten et al.	D9/444
D546,188 S *	7/2007	Penfold et al.	D9/529
D546,694 S *	7/2007	Penfold et al.	D9/529
D588,011 S *	3/2009	Shimizu	D9/552
D588,913 S *	3/2009	Bakic	D9/435
D605,511 S *	12/2009	Weber	D9/449

The broken lines in the drawings depict environmental sub-
ject matter only and form no part of the claimed design.

* cited by examiner

1 Claim, 2 Drawing Sheets

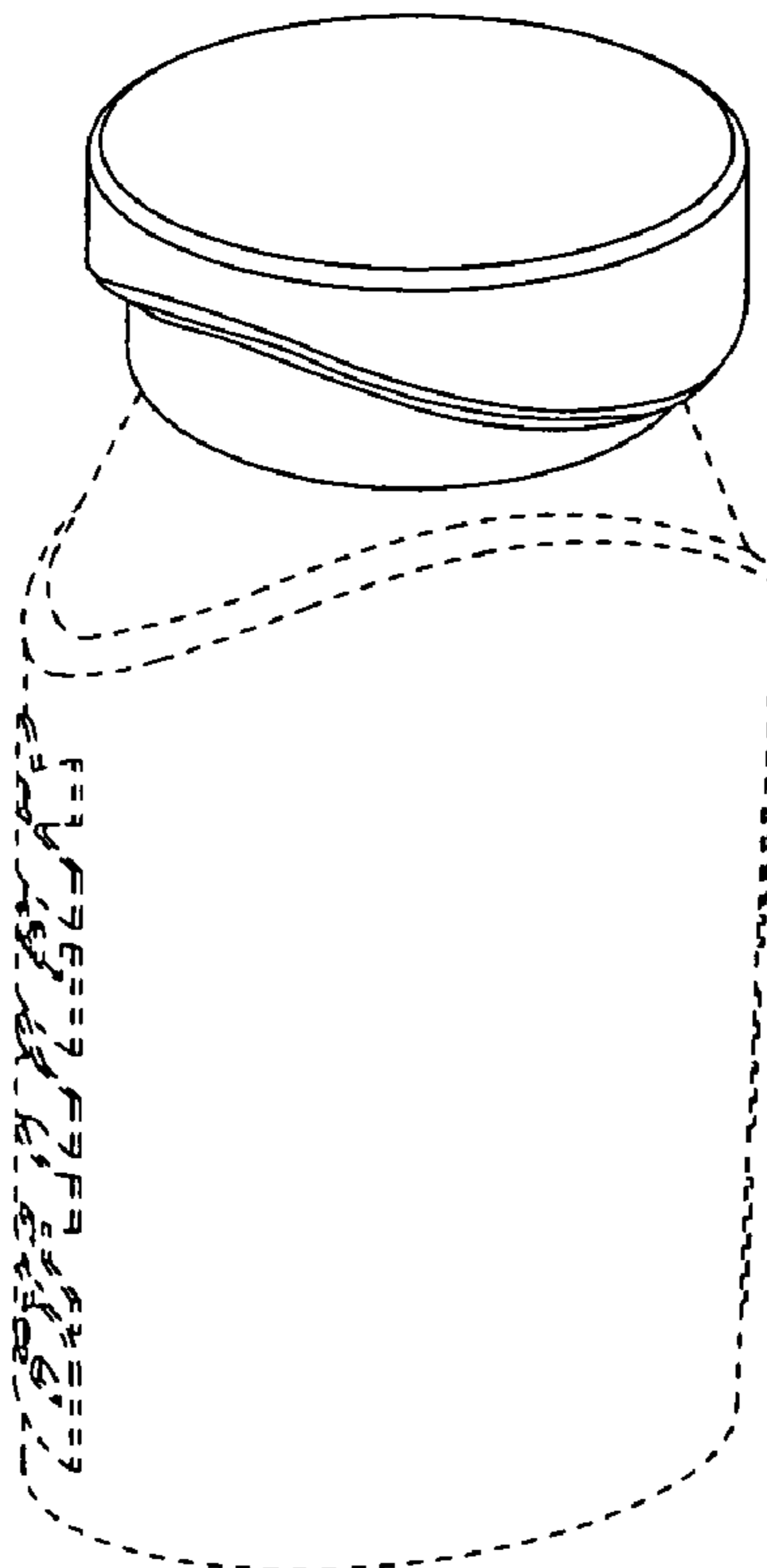

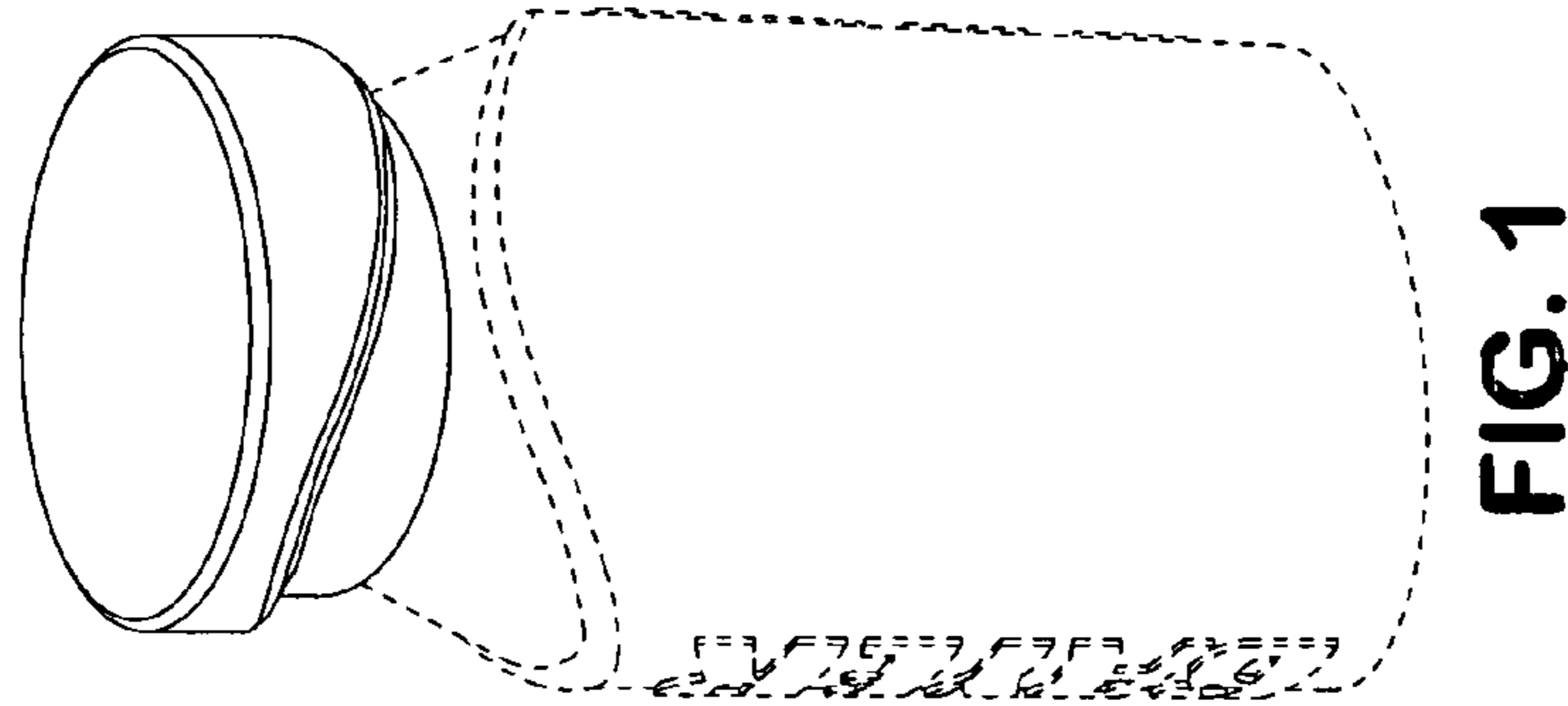

FIG. 1

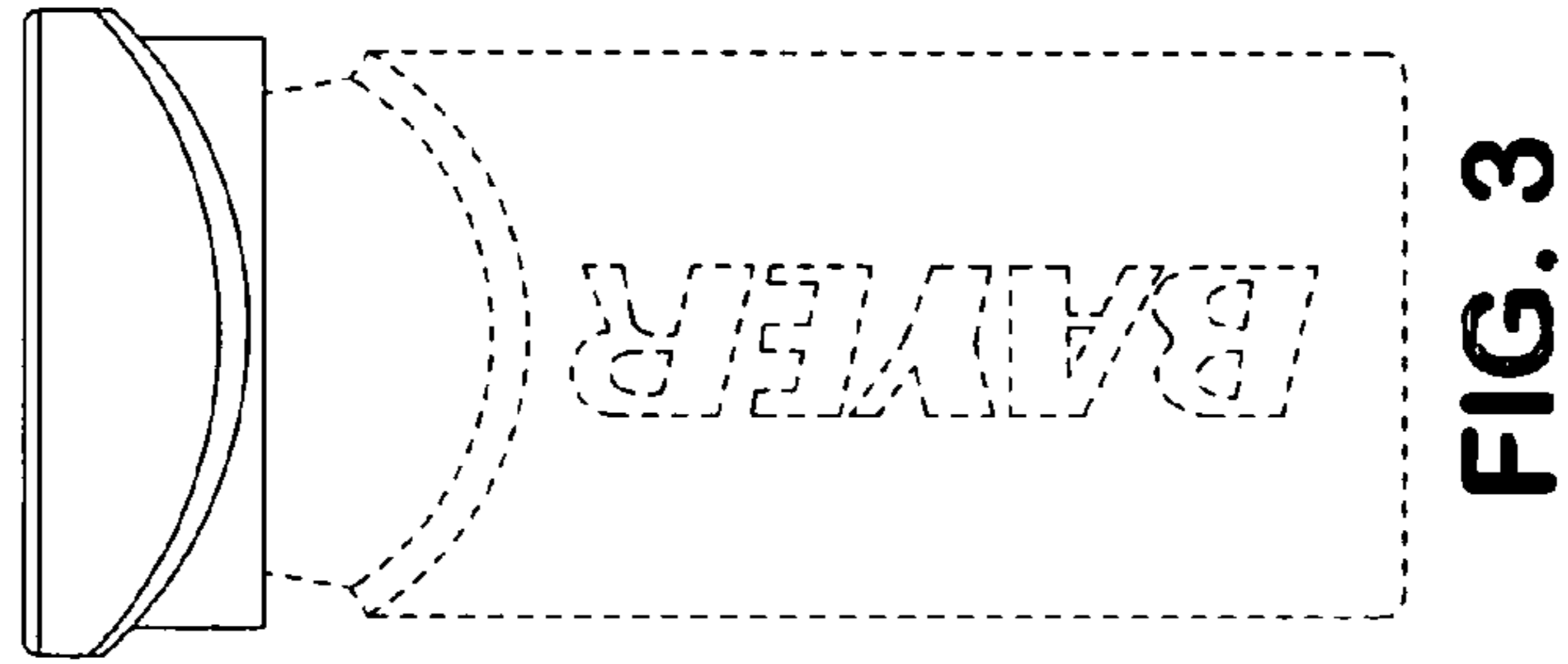

FIG. 3

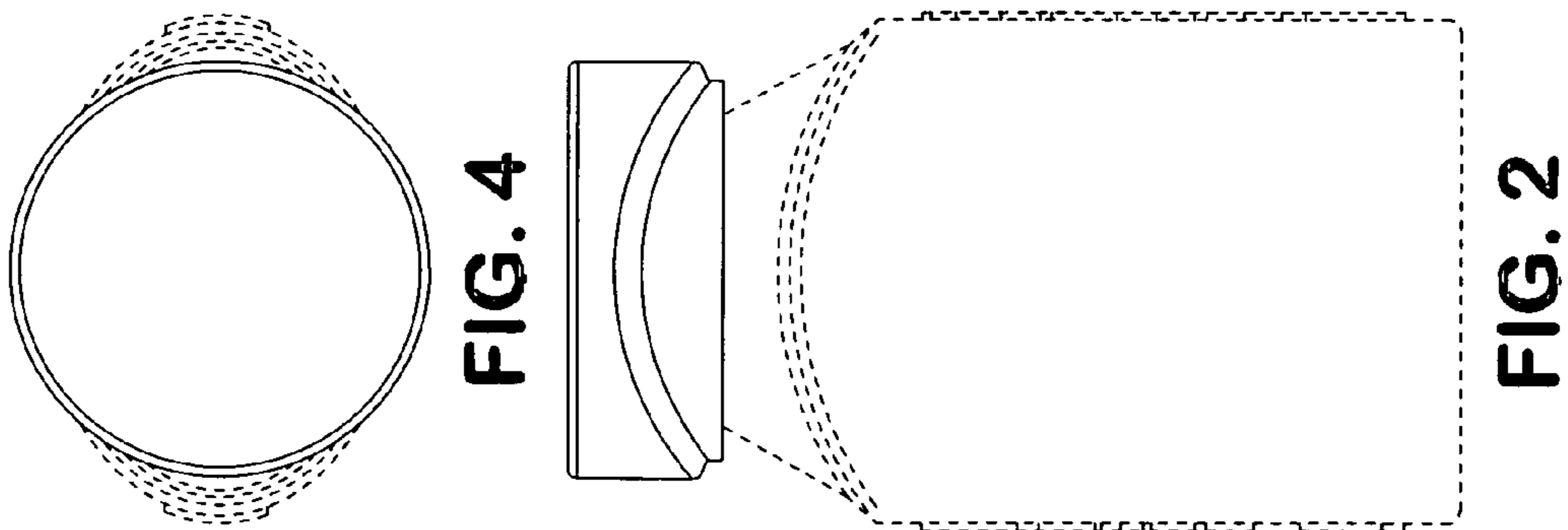

FIG. 2

FIG. 4

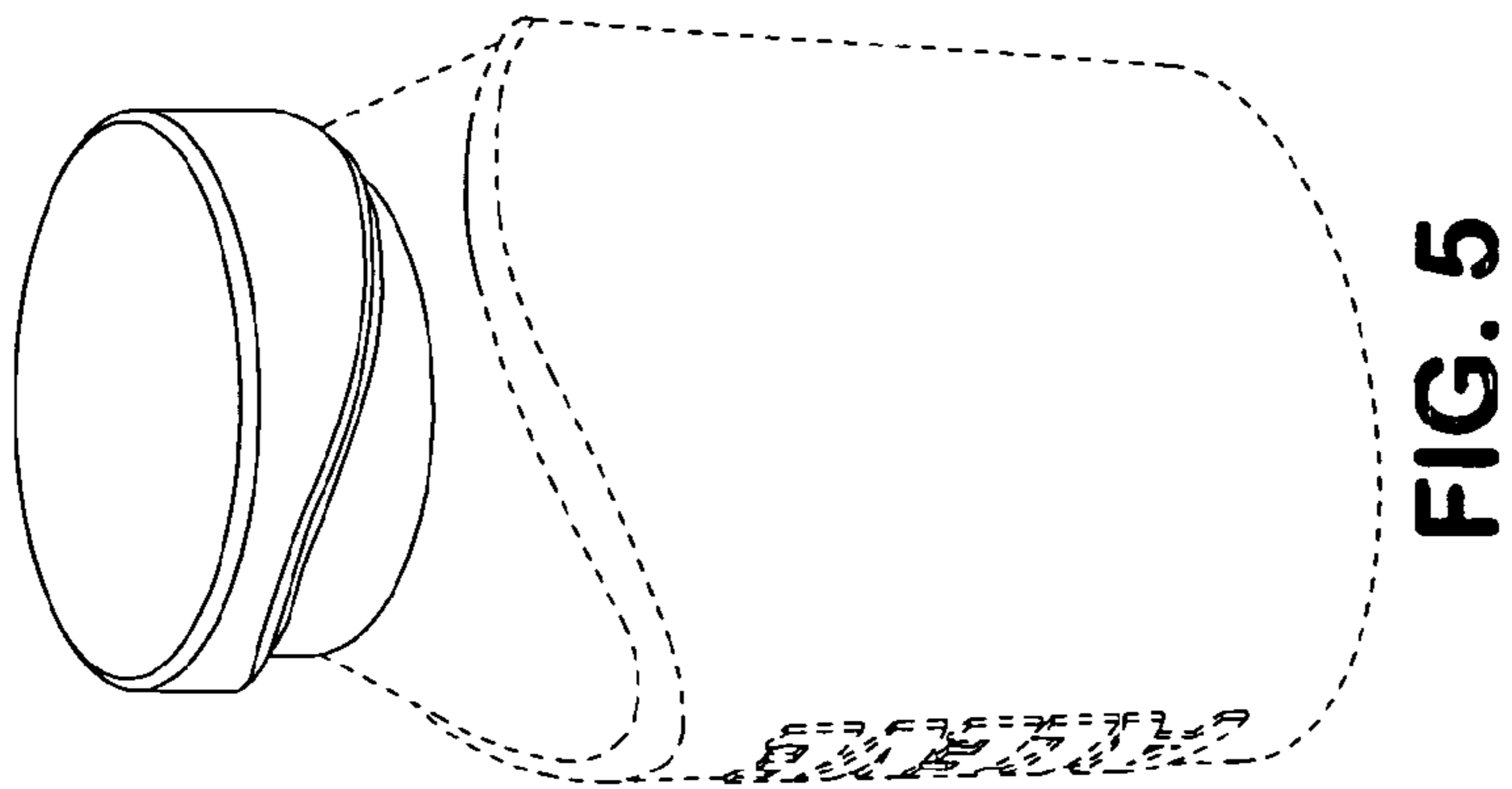

FIG. 5



FIG. 7

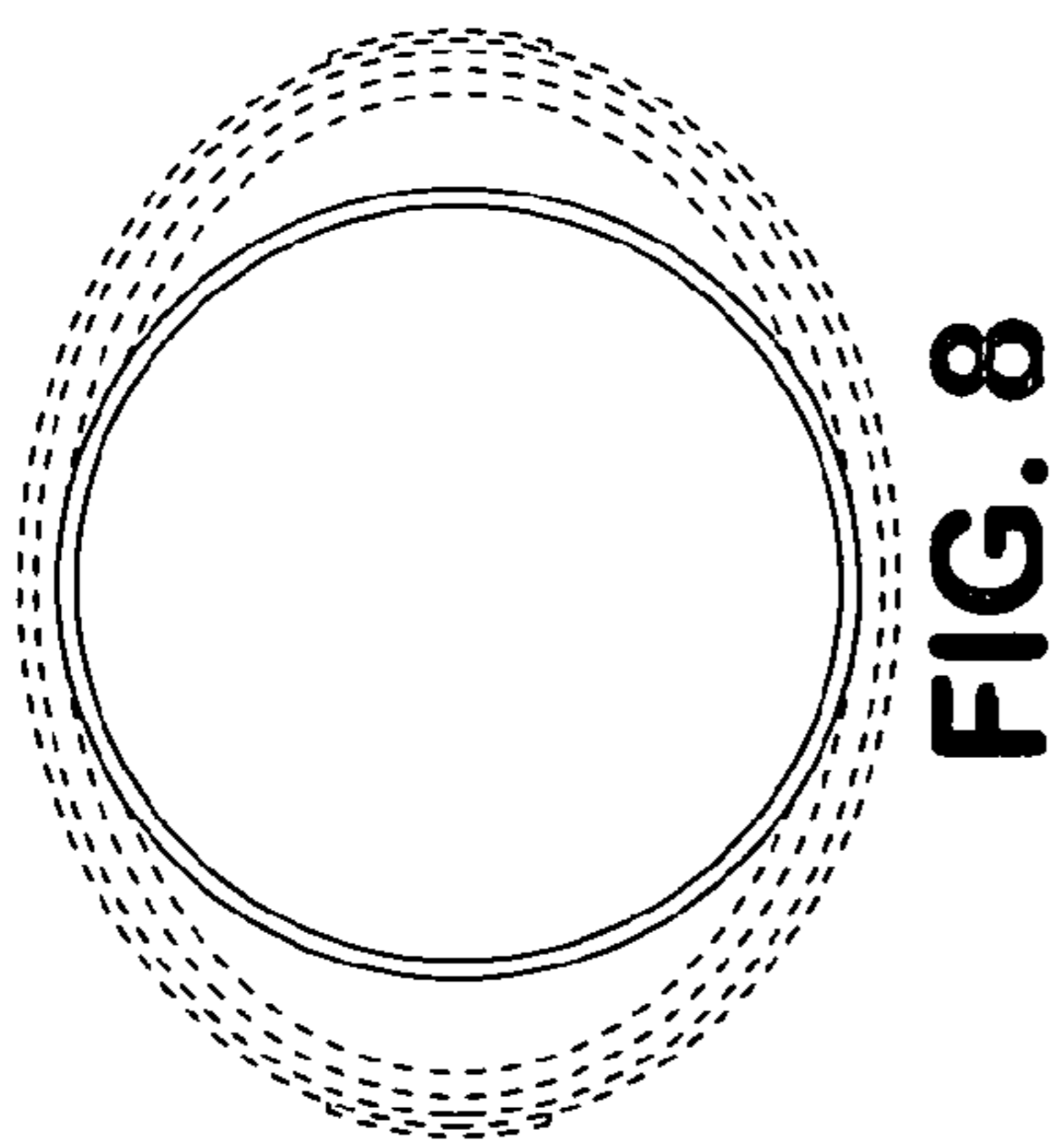

FIG. 8

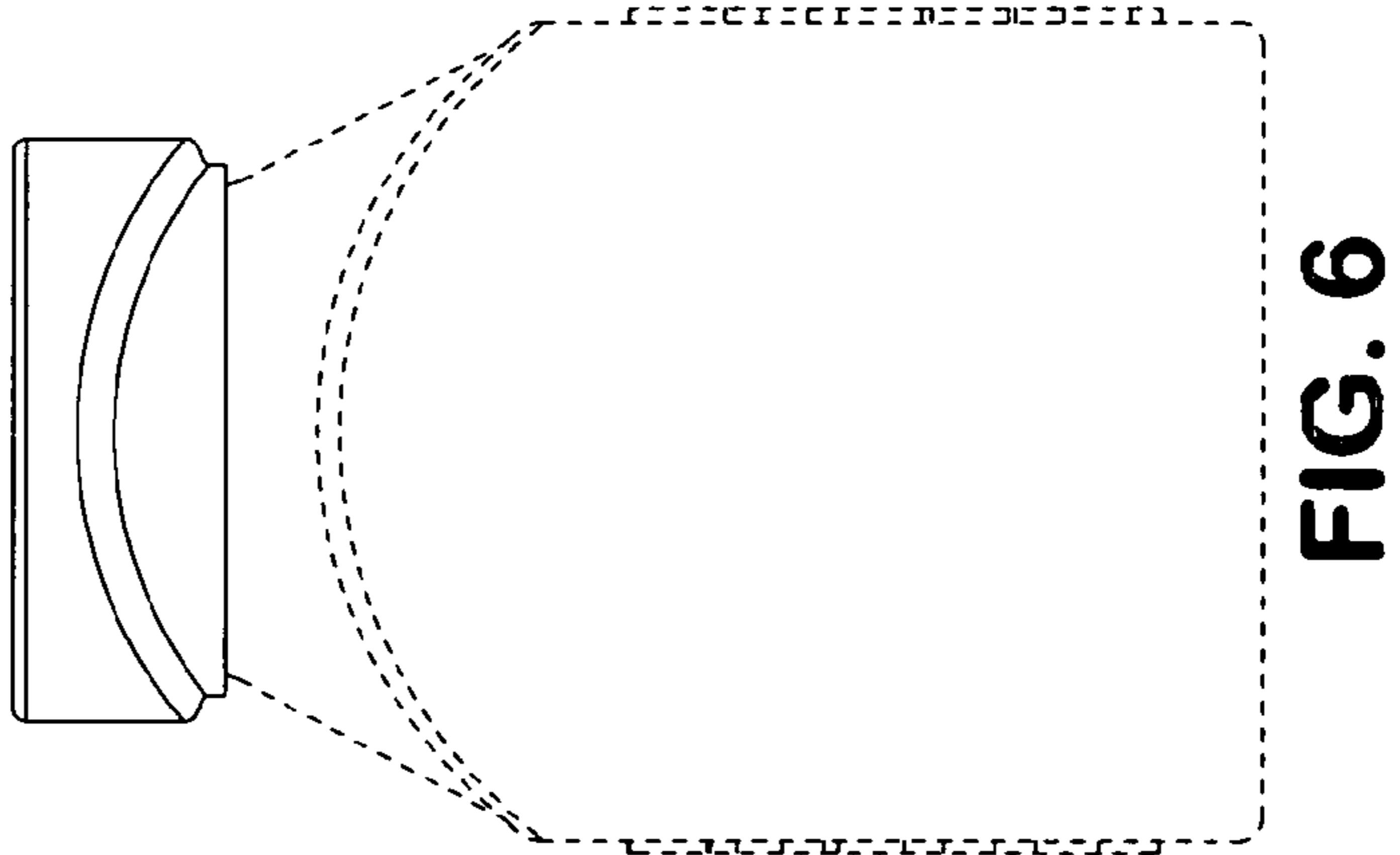

FIG. 6