



US00D617960S

(12) **United States Design Patent**  
**Bohm et al.**

(10) **Patent No.:** **US D617,960 S**  
(45) **Date of Patent:** **\*\* Jun. 15, 2010**

(54) **LAUNDRY APPLIANCE**

(75) Inventors: **Andreas Bohm**, Berlin (DE); **Klaus Försterling**, Evenhausen (DE); **Kemal Genc**, Berlin (DE); **Johannes Geyer**, Haar (DE); **Stefan Schmidt**, Kleinmachnow (DE)

(73) Assignee: **BSH Bosch und Siemens Hausgeraete GmbH**, Munich (DE)

(\*\*) Term: **14 Years**

(21) Appl. No.: **29/353,198**

(22) Filed: **Jan. 5, 2010**

(30) **Foreign Application Priority Data**

Jul. 10, 2009 (EM) ..... 001154744

(51) **LOC (9) Cl.** ..... **15-05**

(52) **U.S. Cl.** ..... **D32/6; D32/8**

(58) **Field of Classification Search** ..... D32/5-6,  
D32/8, 10, 1; 68/3 R, 5 R, 12.01, 12.08;  
34/523-524; 312/31; 38/1 A

See application file for complete search history.

(56) **References Cited**

**U.S. PATENT DOCUMENTS**

D271,147 S *	10/1983	Krebs	.....	D32/6
D271,148 S *	10/1983	Krebs	.....	D32/6
D518,250 S *	3/2006	Kirk et al.	.....	D32/6
D539,490 S *	3/2007	Sans Rovira et al.	.....	D32/6
D563,062 S *	2/2008	Eicher et al.	.....	D32/6
7,325,332 B2 *	2/2008	Chung et al.	.....	34/602
D565,809 S *	4/2008	Eicher et al.	.....	D32/6
D582,106 S *	12/2008	Kim et al.	.....	D32/6
D589,217 S *	3/2009	Park et al.	.....	D32/6

\* cited by examiner

*Primary Examiner*—T. Chase Nelson  
*Assistant Examiner*—Kathleen M Sims

(74) *Attorney, Agent, or Firm*—James E. Howard; Andre Pallapies

(57) **CLAIM**

The ornamental design for a laundry appliance, as shown and described.

**DESCRIPTION**

FIG. 1 is a front, right, perspective view of a first embodiment of a laundry appliance showing our new design;

FIG. 2 is a FRONT view thereof;

FIG. 3 is a LEFT SIDE view thereof;

FIG. 4 is a RIGHT SIDE view thereof;

FIG. 5 is a TOP view thereof;

FIG. 6 is a front, right, perspective view of a second embodiment of a laundry appliance;

FIG. 7 is a FRONT view thereof;

FIG. 8 is a LEFT side view thereof;

FIG. 9 is a RIGHT side view thereof;

FIG. 10 is a TOP view thereof;

FIG. 11 is a front, right, perspective view of a third embodiment of a laundry appliance;

FIG. 12 is a FRONT view thereof;

FIG. 13 is a LEFT SIDE view thereof;

FIG. 14 is a RIGHT SIDE view thereof;

FIG. 15 is a TOP view thereof;

FIG. 16 is a front, right, perspective view of a fourth embodiment of a laundry appliance;

FIG. 17 is a FRONT view thereof;

FIG. 18 is a LEFT SIDE view thereof;

FIG. 19 is a RIGHT SIDE view thereof; and,

FIG. 20 is a TOP view thereof.

The rear and bottom views of each embodiment are unornamented and/or unclaimed and are therefore not provided.

**1 Claim, 20 Drawing Sheets**

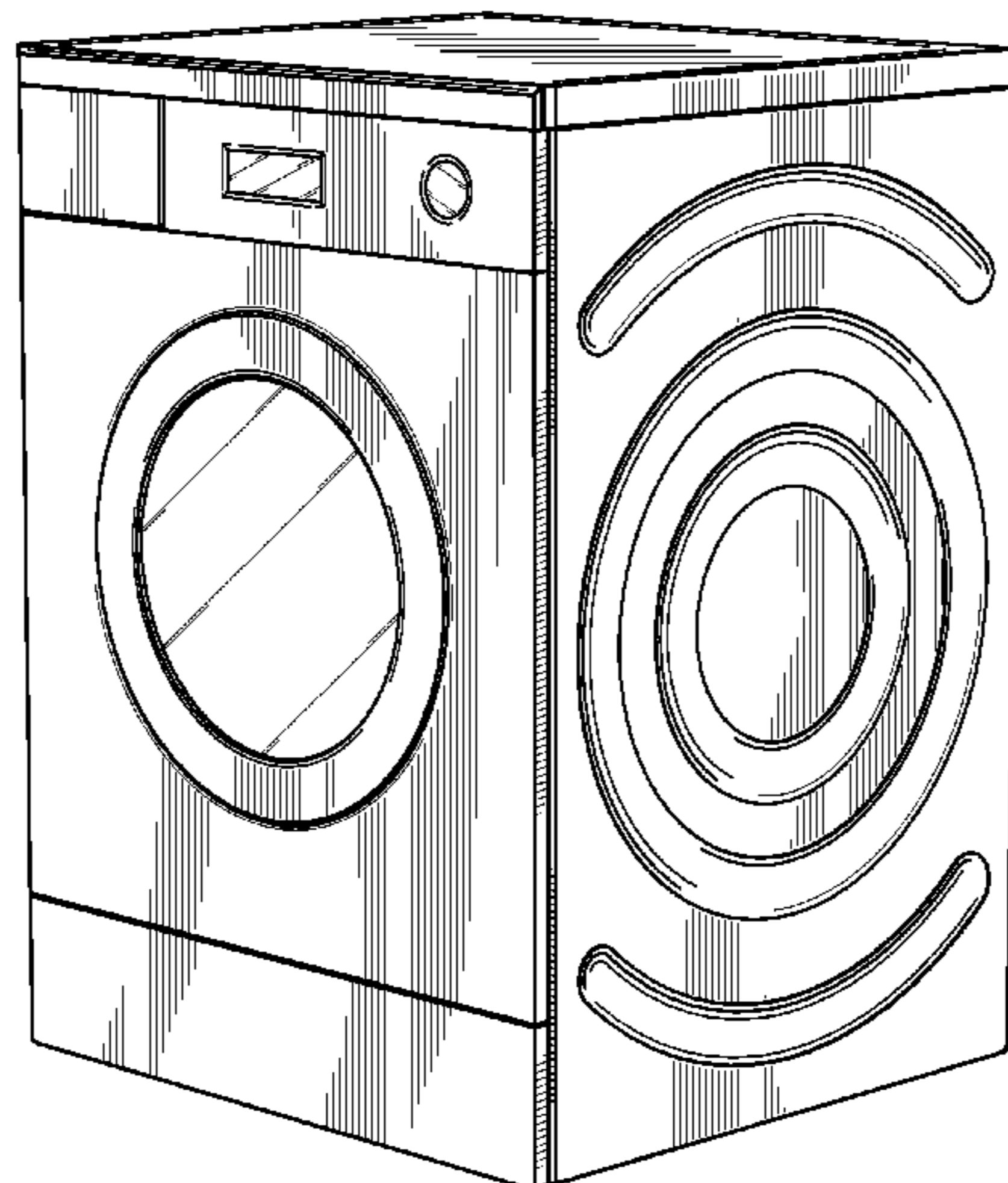

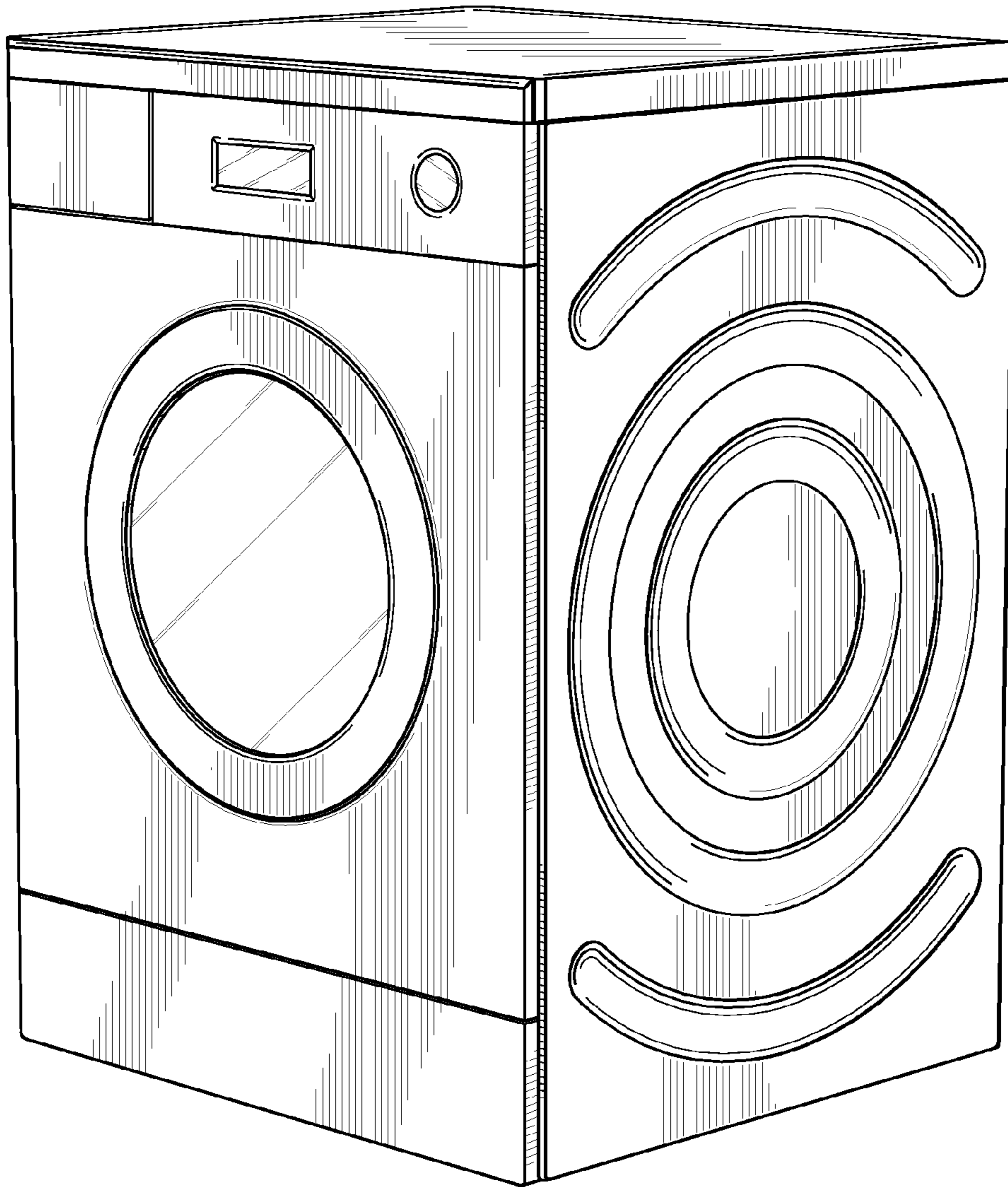

Fig. 1

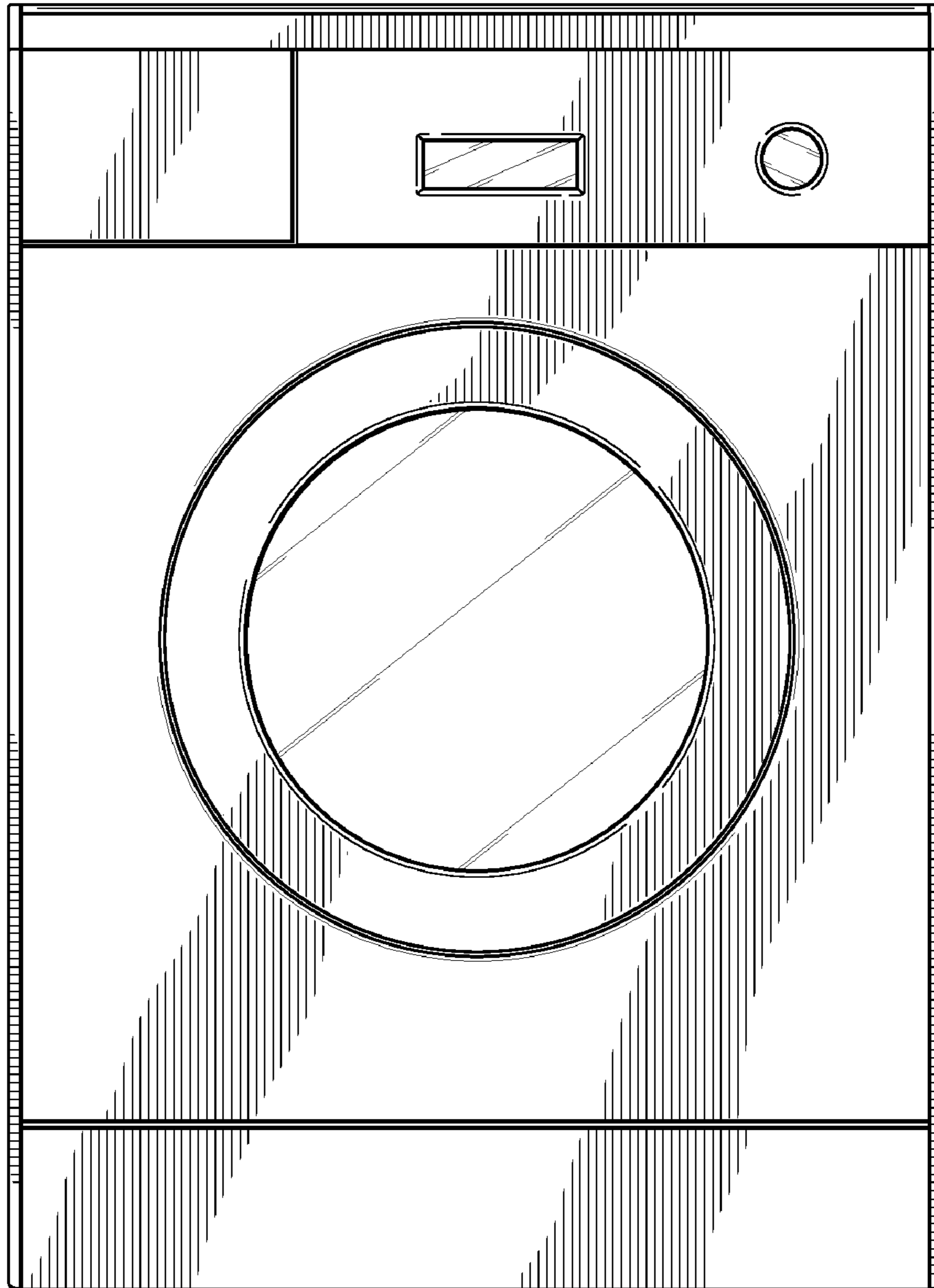

Fig. 2

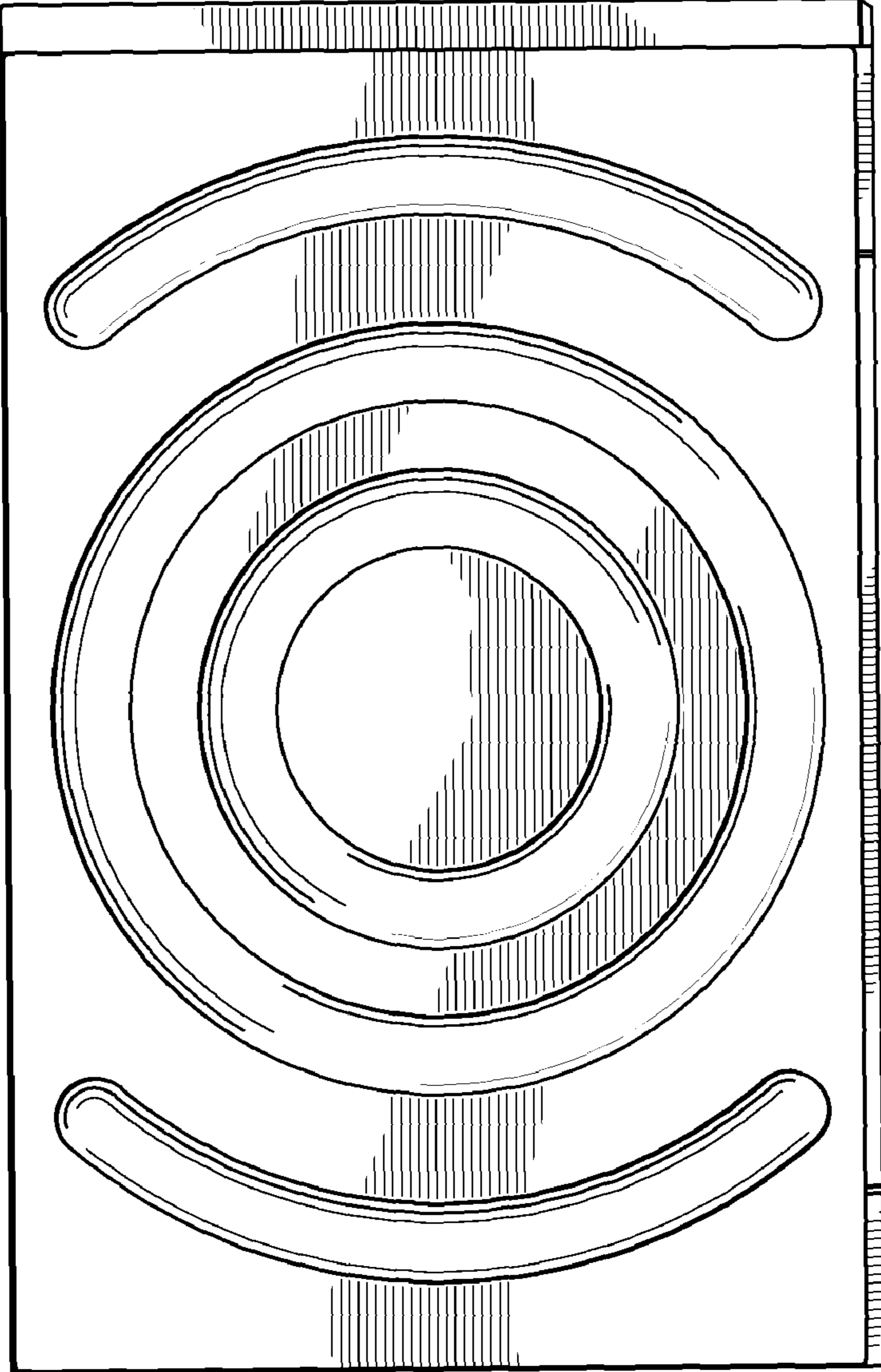

Fig. 3

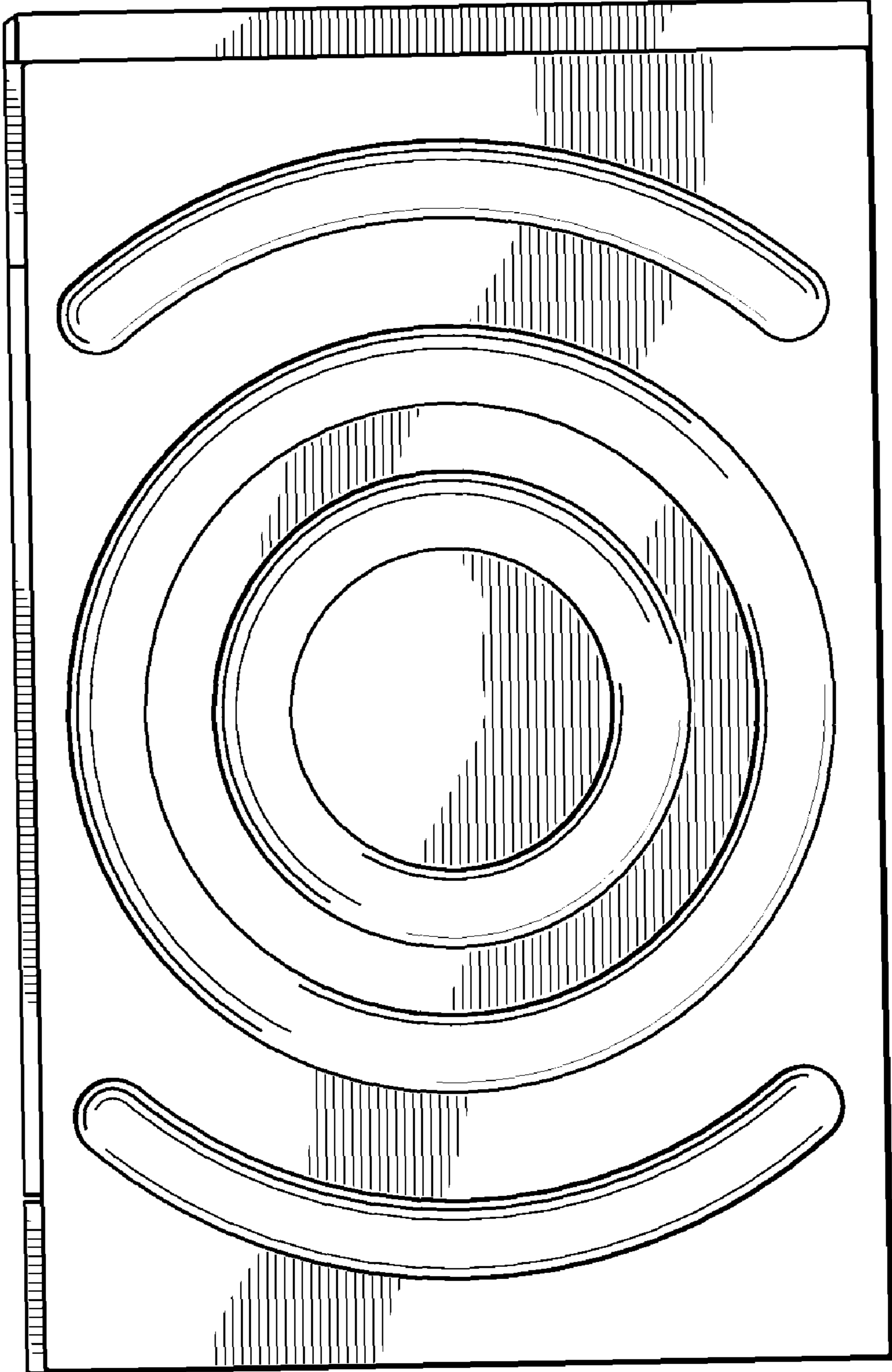

Fig. 4

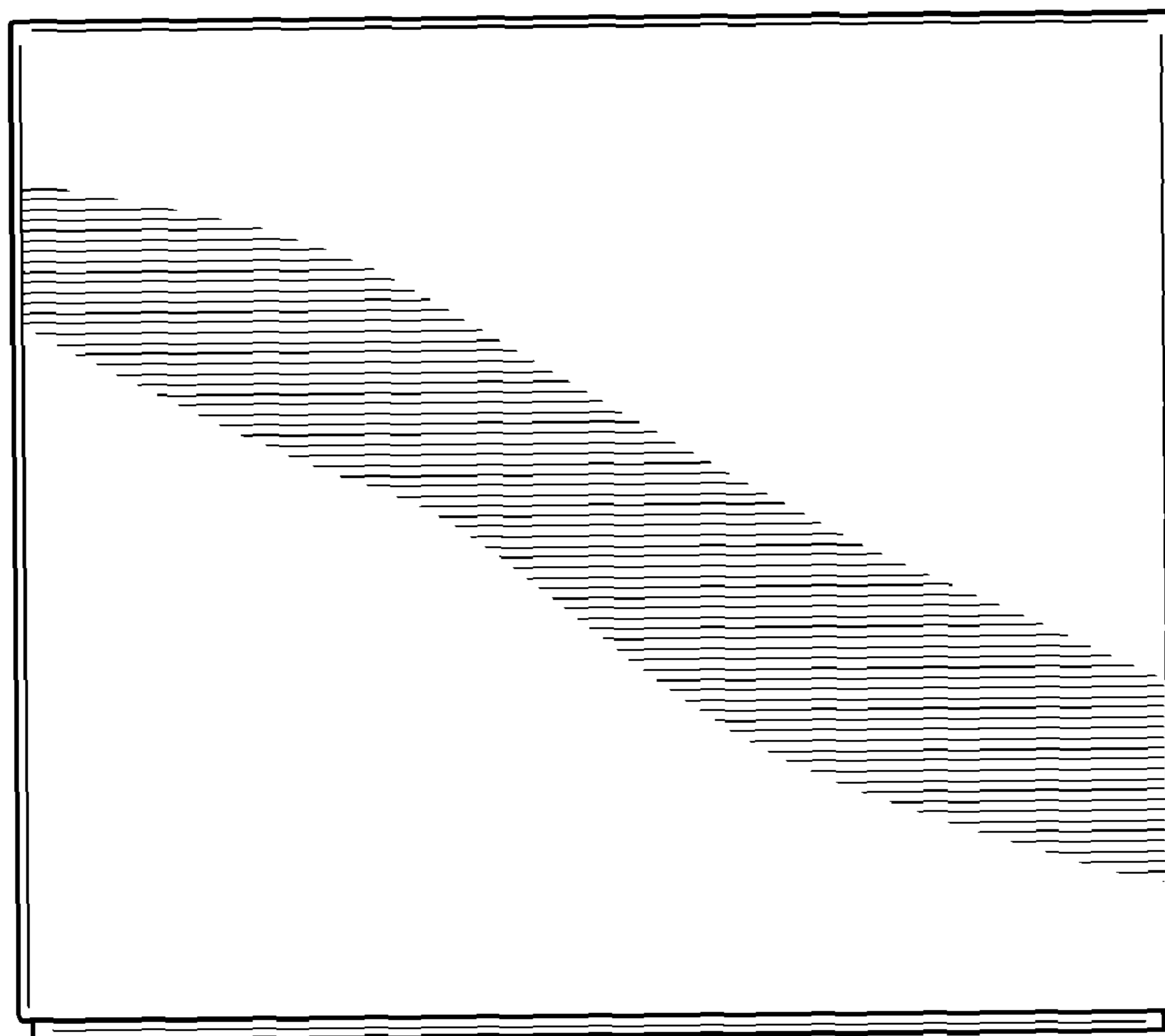

Fig. 5

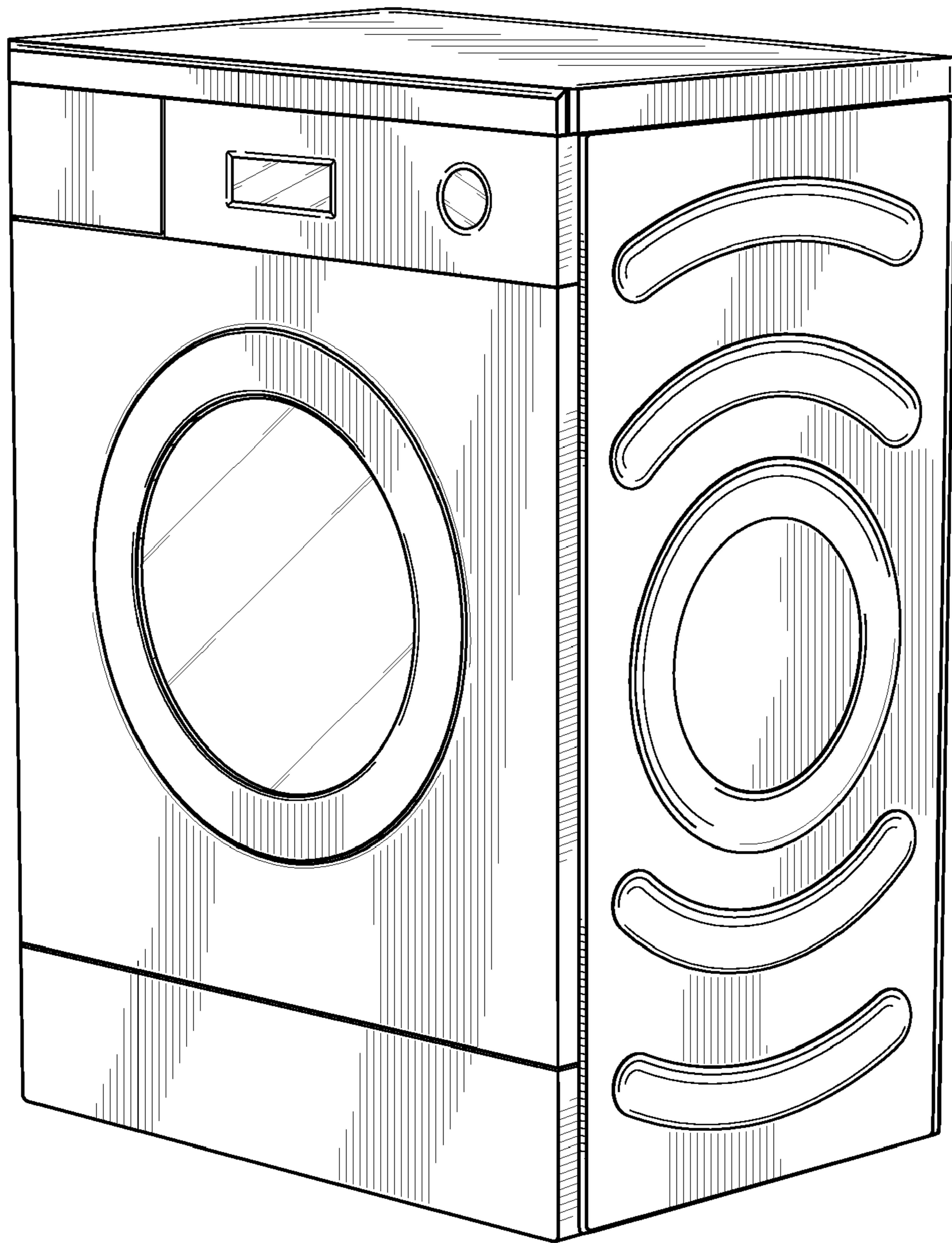

Fig. 6

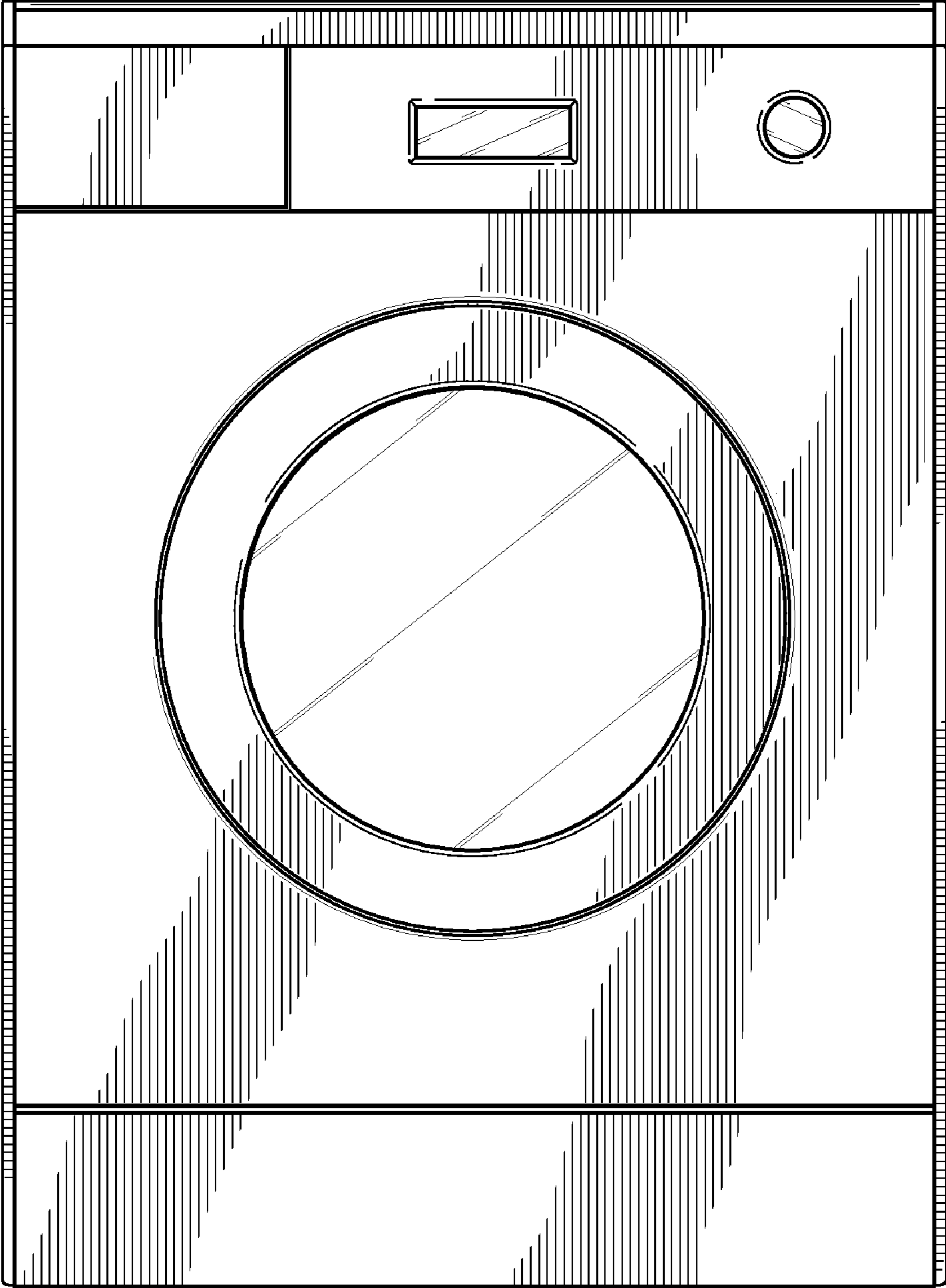

Fig. 7



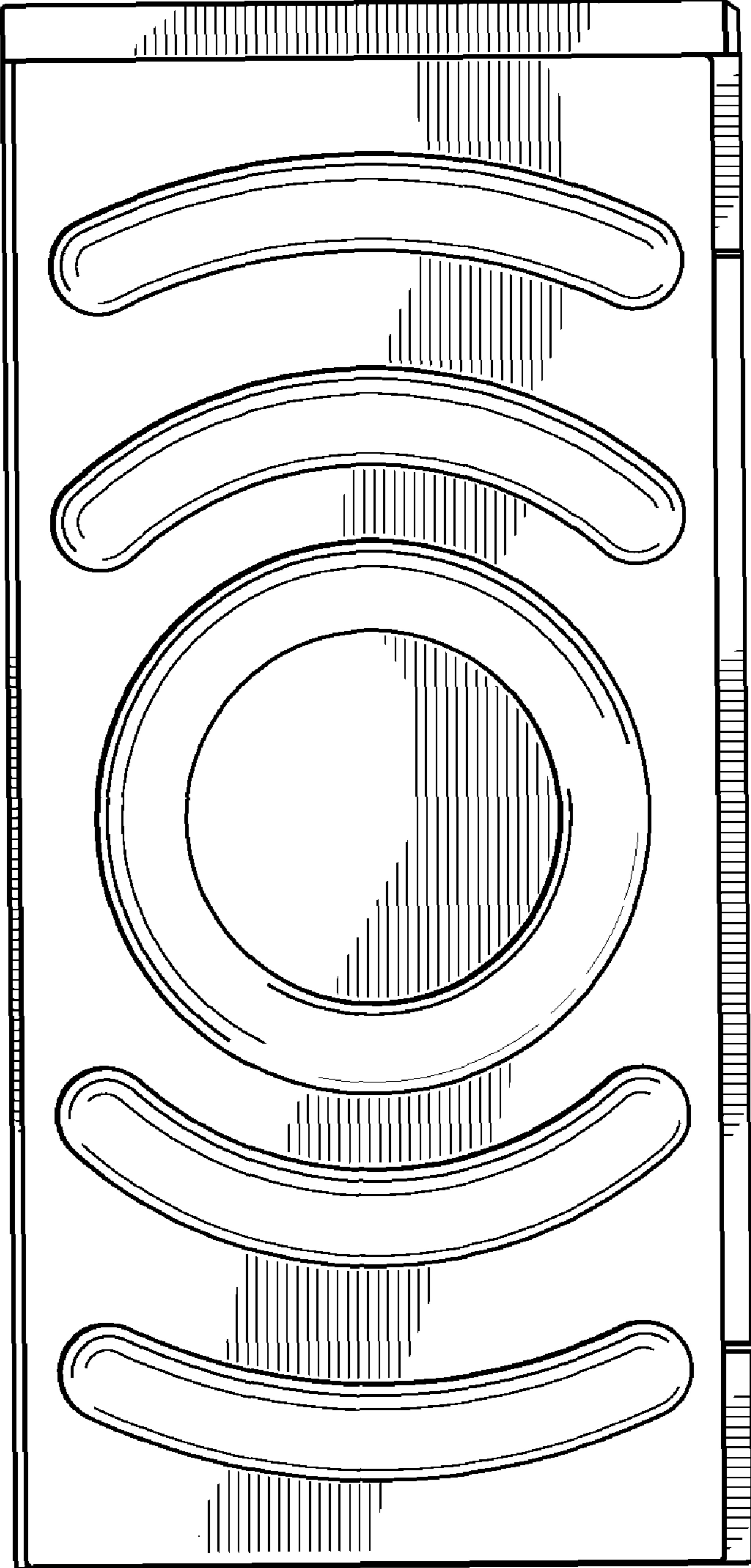

Fig. 8

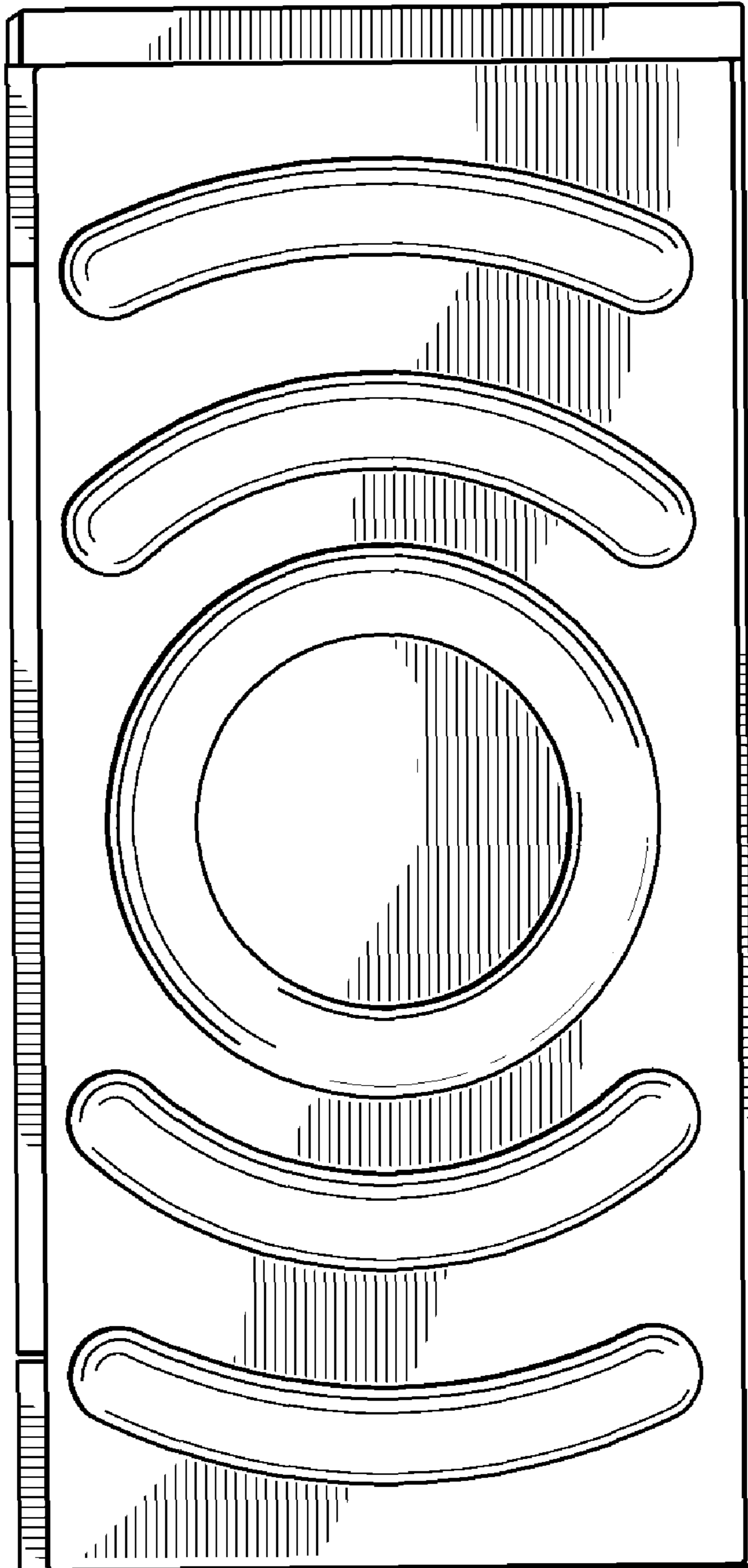

Fig. 9

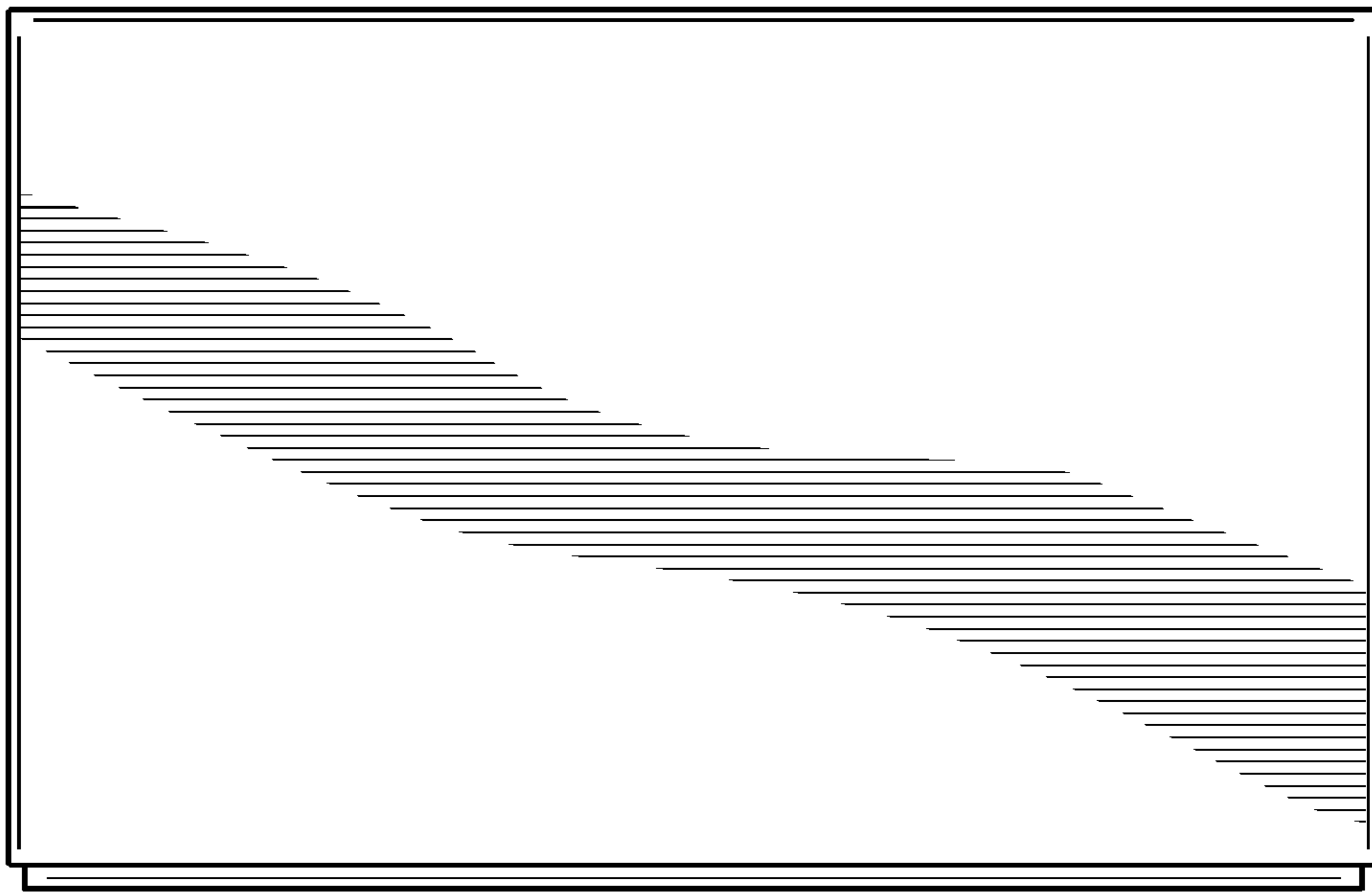

Fig. 10

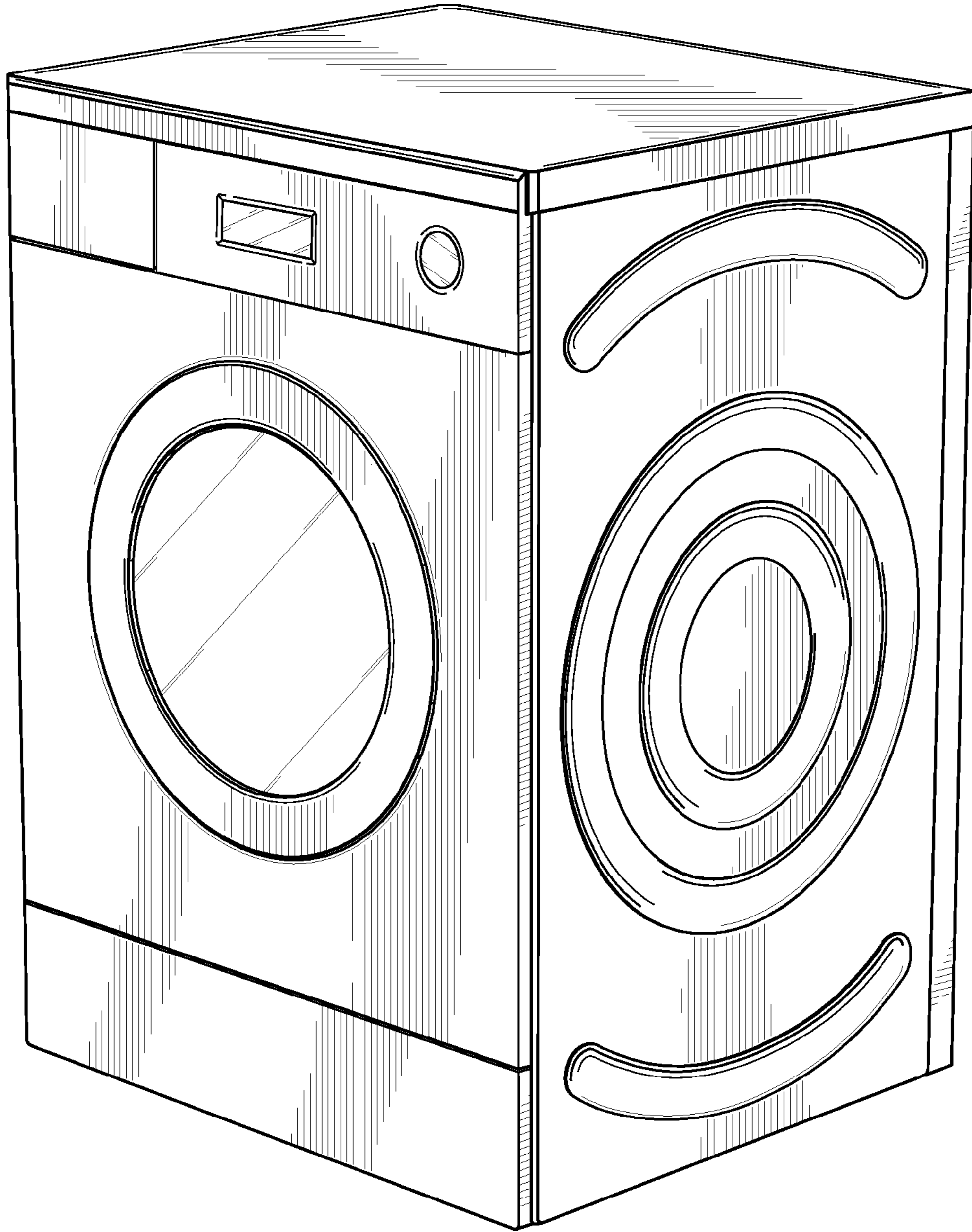

Fig. 11

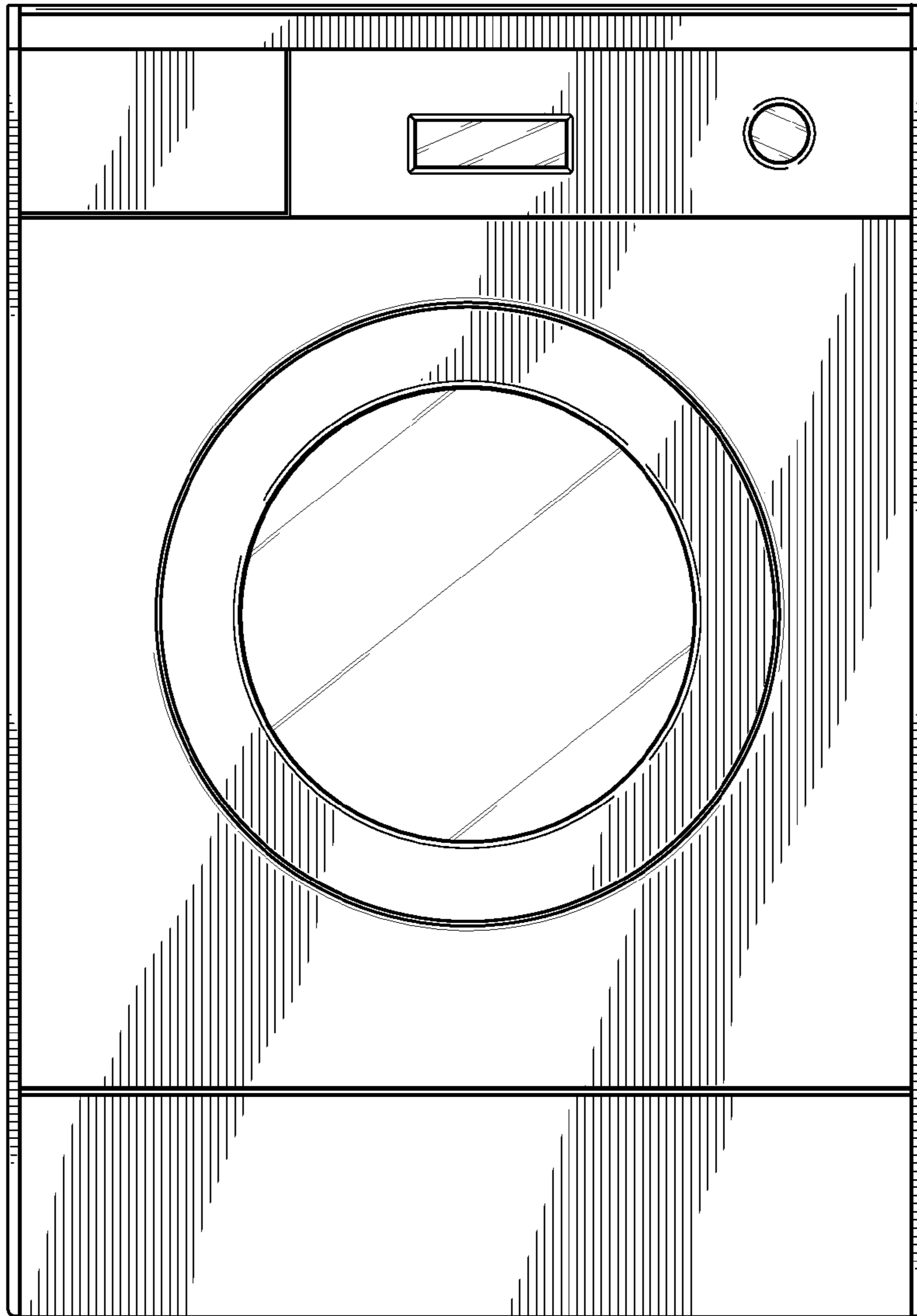

Fig. 12

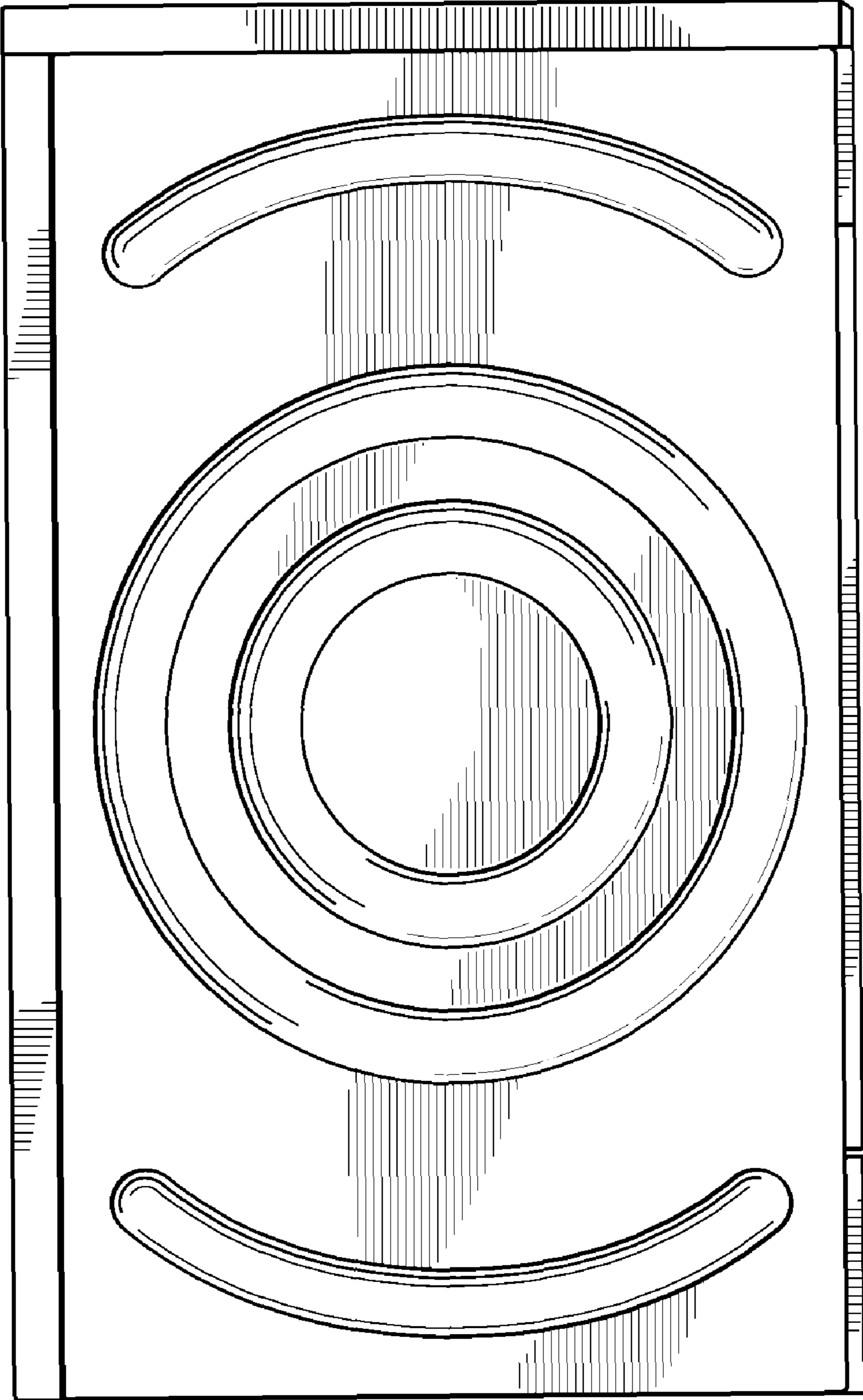

Fig. 13

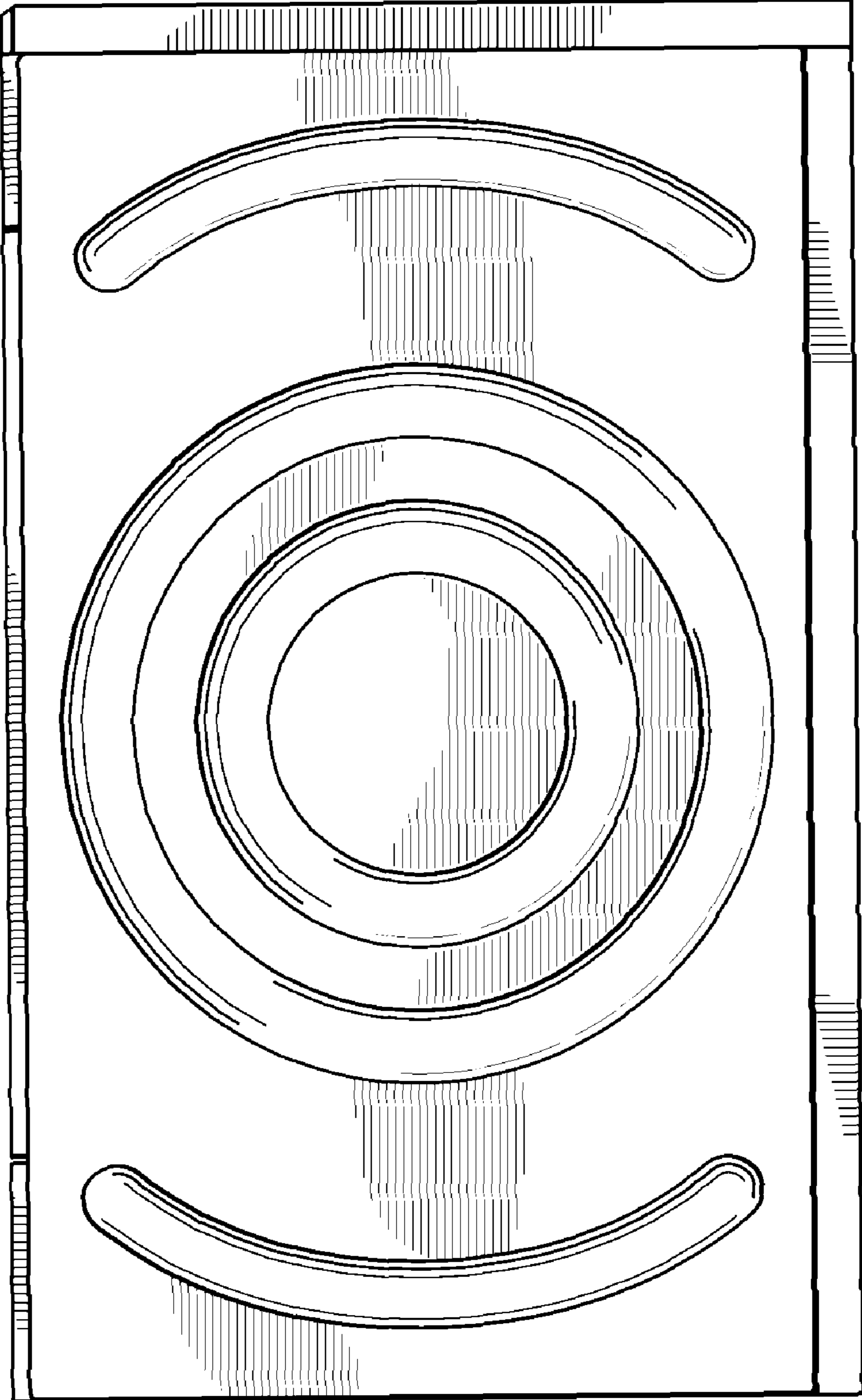

Fig. 14

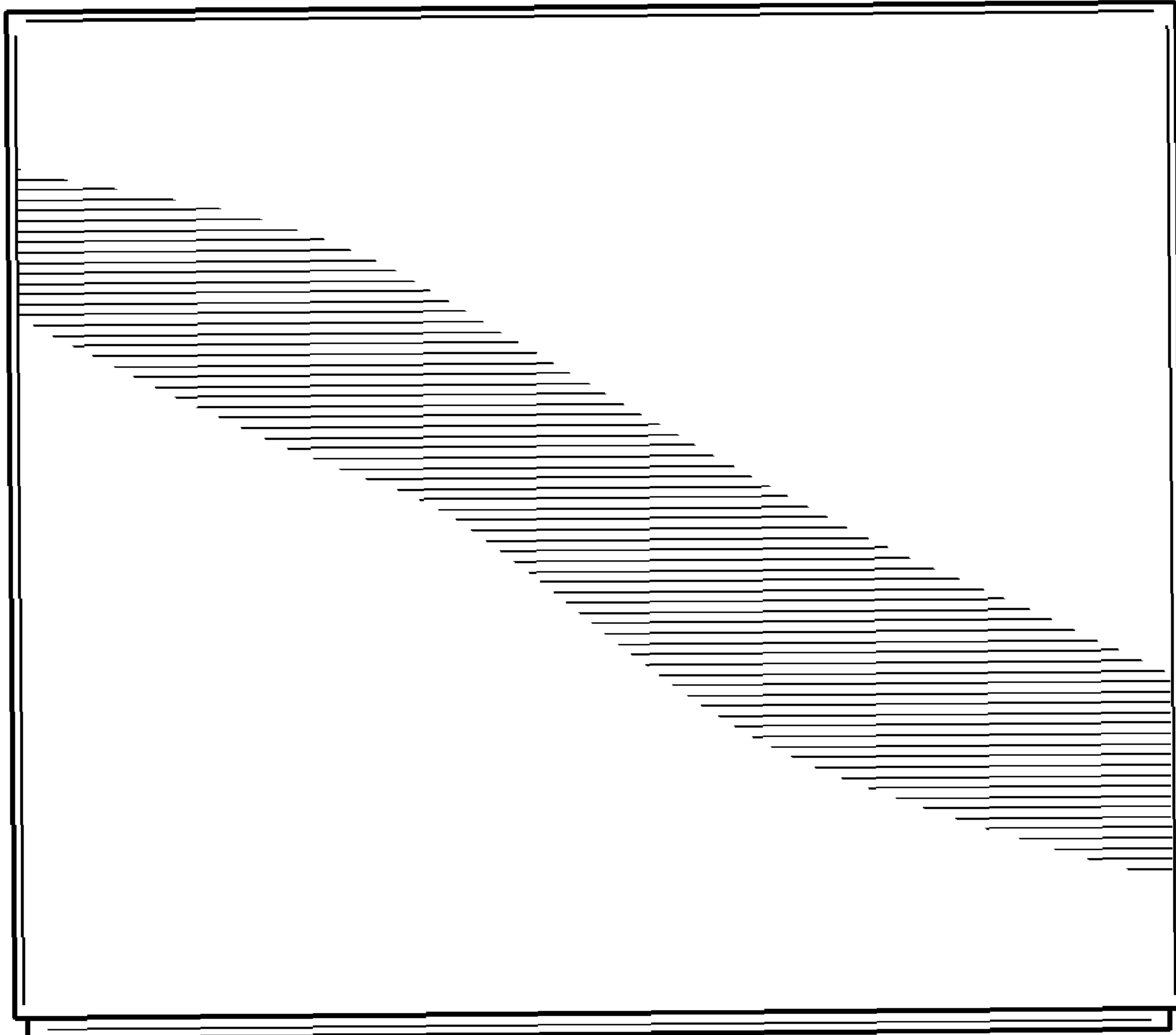

Fig. 15



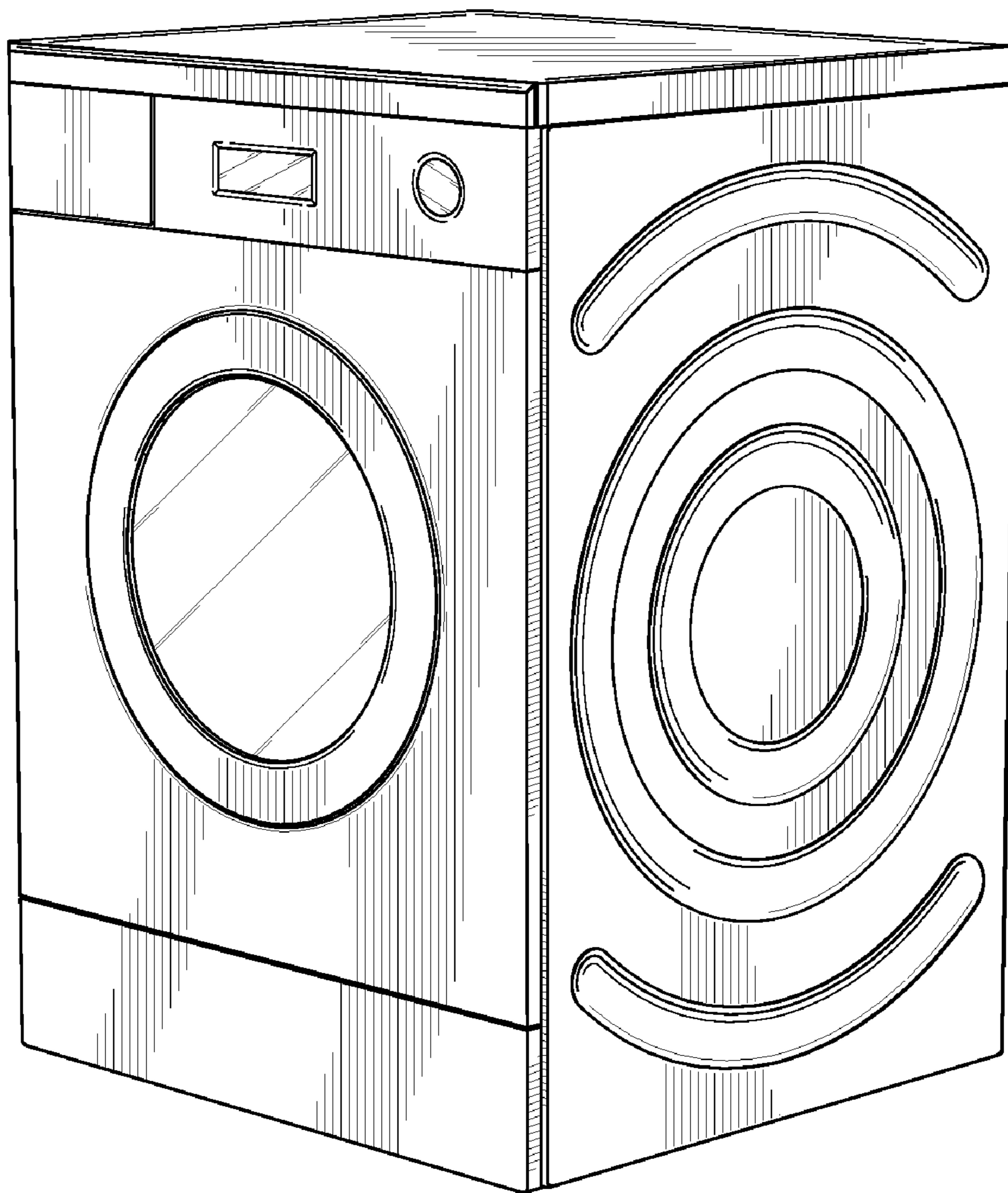

Fig. 16

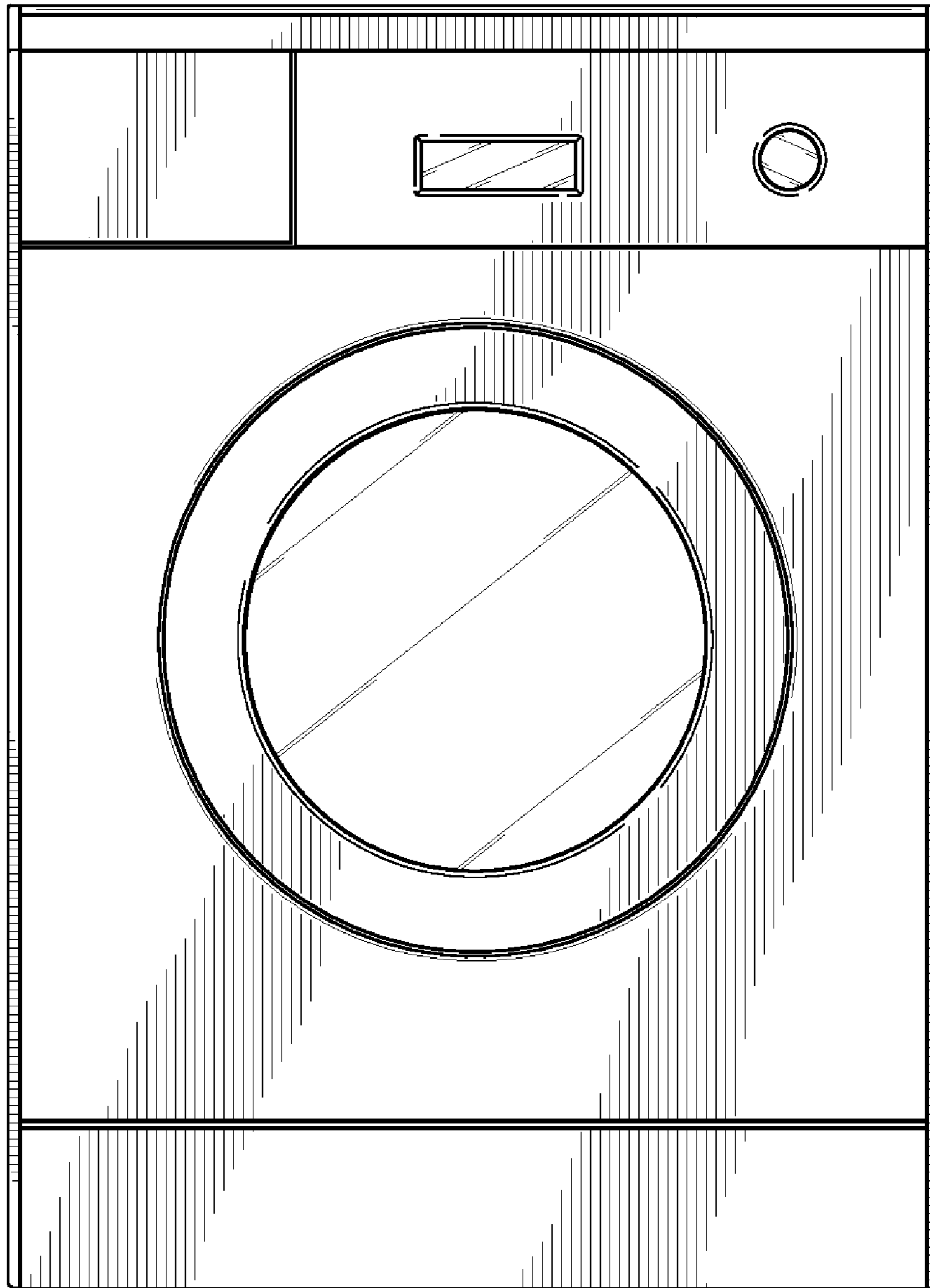

Fig. 17

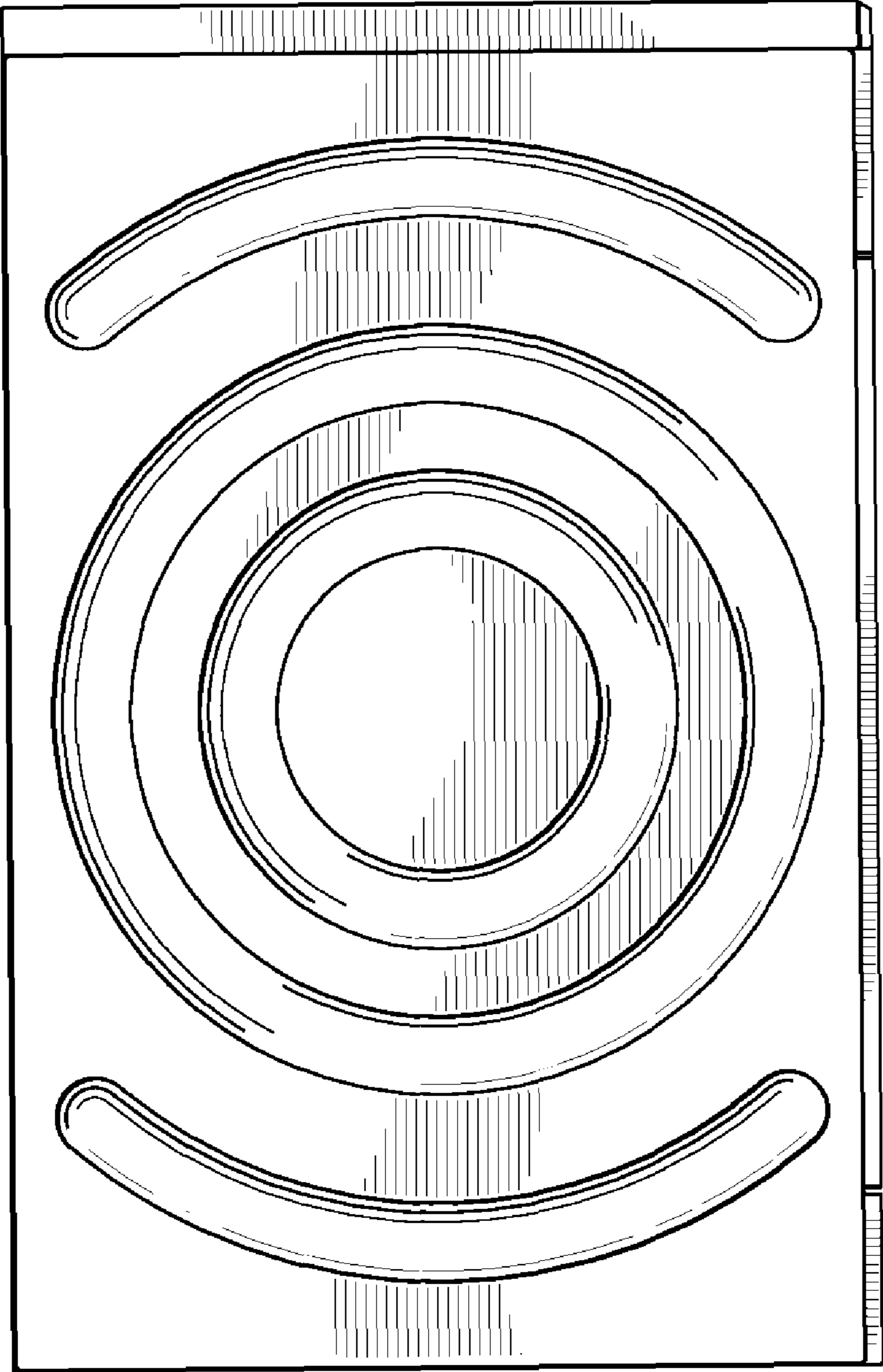

Fig. 18

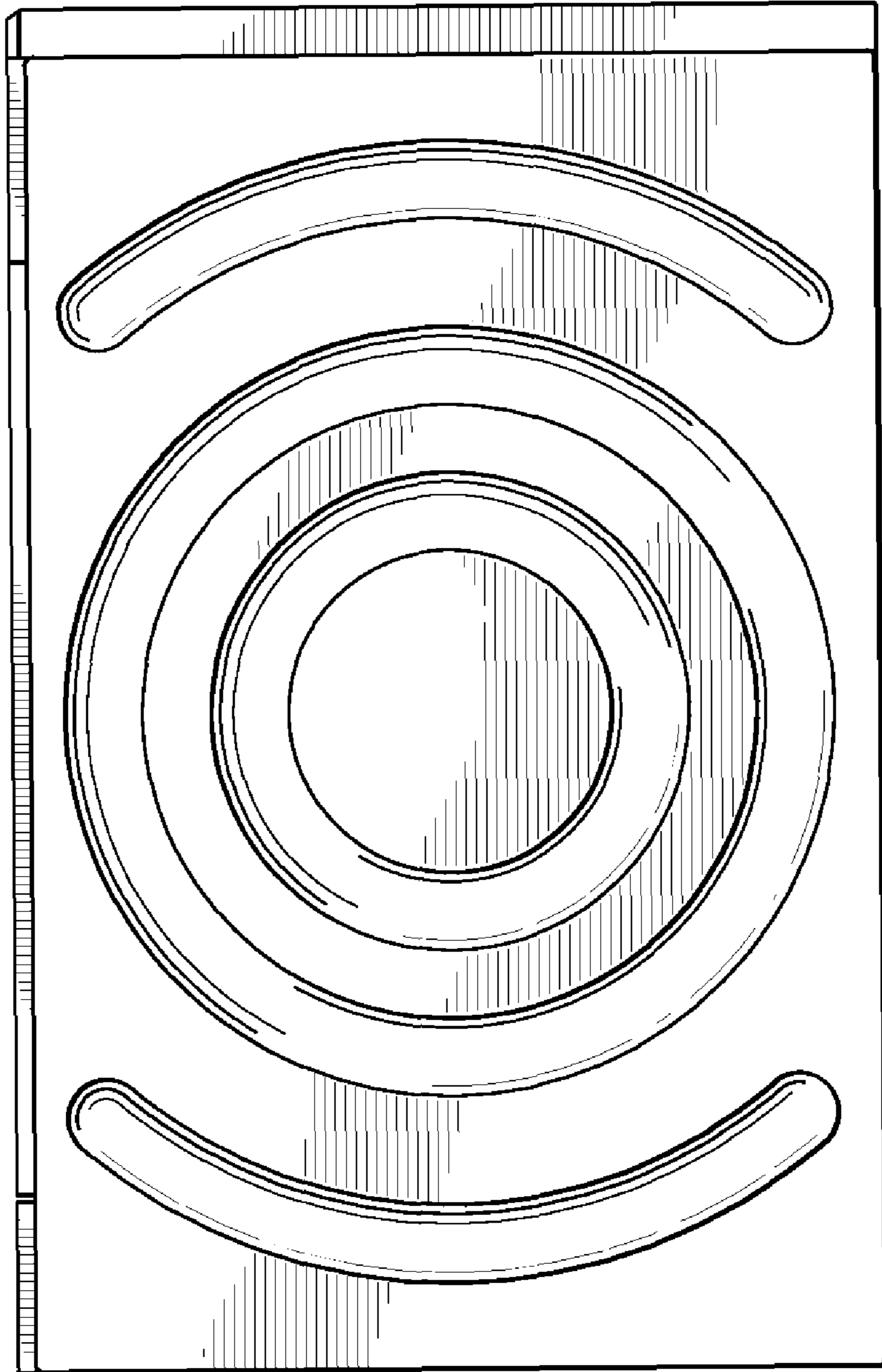

Fig. 19

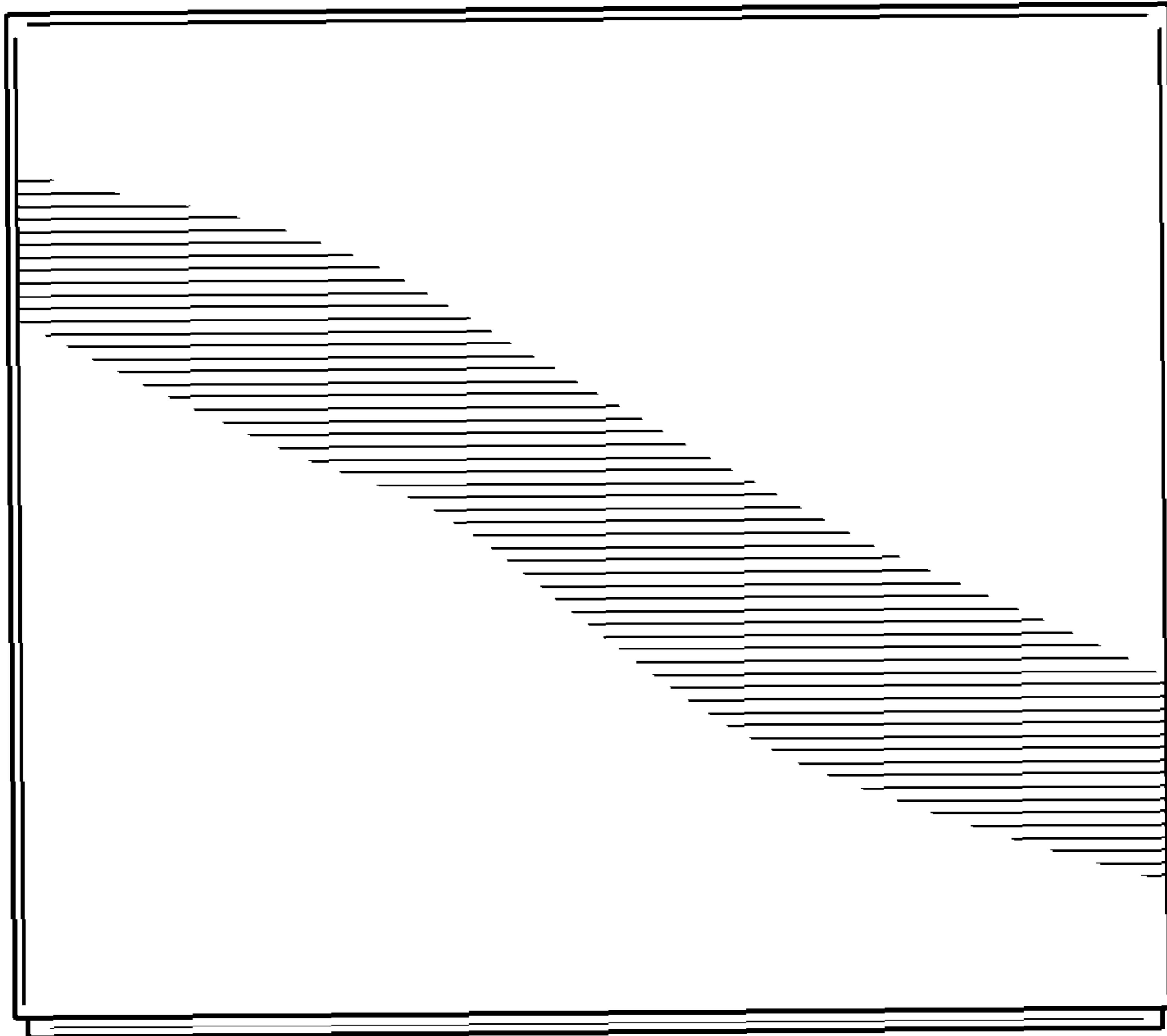

Fig. 20