



US00D617951S

(12) **United States Design Patent**
Shen

(10) **Patent No.:** **US D617,951 S**
(45) **Date of Patent:** **** Jun. 15, 2010**

(54) **BLADE SET FOR A SAFETY RAZOR WITH TRIMMER**

2007/0089578 A1* 4/2007 Zoot 30/43.92

OTHER PUBLICATIONS

Commonly assigned application for patent, U.S. Appl. No. 29/323,265, filed Aug. 21, 2008.

* cited by examiner

Primary Examiner—Jennifer Rivard

(74) *Attorney, Agent, or Firm*—Energizer Personal Care, LLC

(75) Inventor: **Jia Jun Shen**, New Haven, CT (US)

(73) Assignee: **Eveready Battery Company, Inc.**, St. Louis, MO (US)

(**) Term: **14 Years**

(21) Appl. No.: **29/343,929**

(22) Filed: **Sep. 22, 2009**

(51) **LOC (9) Cl.** **28-03**

(52) **U.S. Cl.** **D28/54**

(58) **Field of Classification Search** 30/29.5,
30/30, 32, 34.05, 34.1, 34.2, 43–43.92, 44–45,
30/526–537, 196, 201, 223, 233, 233.5; D28/44,
D28/44.1, 49–54

See application file for complete search history.

(57) **CLAIM**

The ornamental design for the blade set for a safety razor with trimmer, as shown and described.

DESCRIPTION

FIG. 1 is a lower perspective view of a blade set for a safety razor with trimmer.

FIG. 2 is an upper perspective view thereof.

FIG. 3 is a rear view thereof.

FIG. 4 is a right view of FIG. 3.

FIG. 5 is a front view thereof.

FIG. 6 is a right view of FIG. 5.

FIG. 7 is a bottom end view thereof; and,

FIG. 8 is a top end view thereof.

The broken lines in the figures depict environmental subject matter only and form no part of the claimed design.

(56) **References Cited**

U.S. PATENT DOCUMENTS

D432,265 S *	10/2000	Kling et al.	D28/53
D458,411 S *	6/2002	Abraham et al.	D28/53
D470,272 S *	2/2003	Fong	D28/53
D568,539 S	5/2008	Micinilio et al.		
D568,541 S *	5/2008	Micinilio	D28/53
D591,453 S	4/2009	Micinilio et al.		
D604,907 S *	11/2009	Emminger	D28/53
2004/0025349 A1 *	2/2004	O	30/43.92
2006/0230621 A1 *	10/2006	Liao	30/223

1 Claim, 4 Drawing Sheets

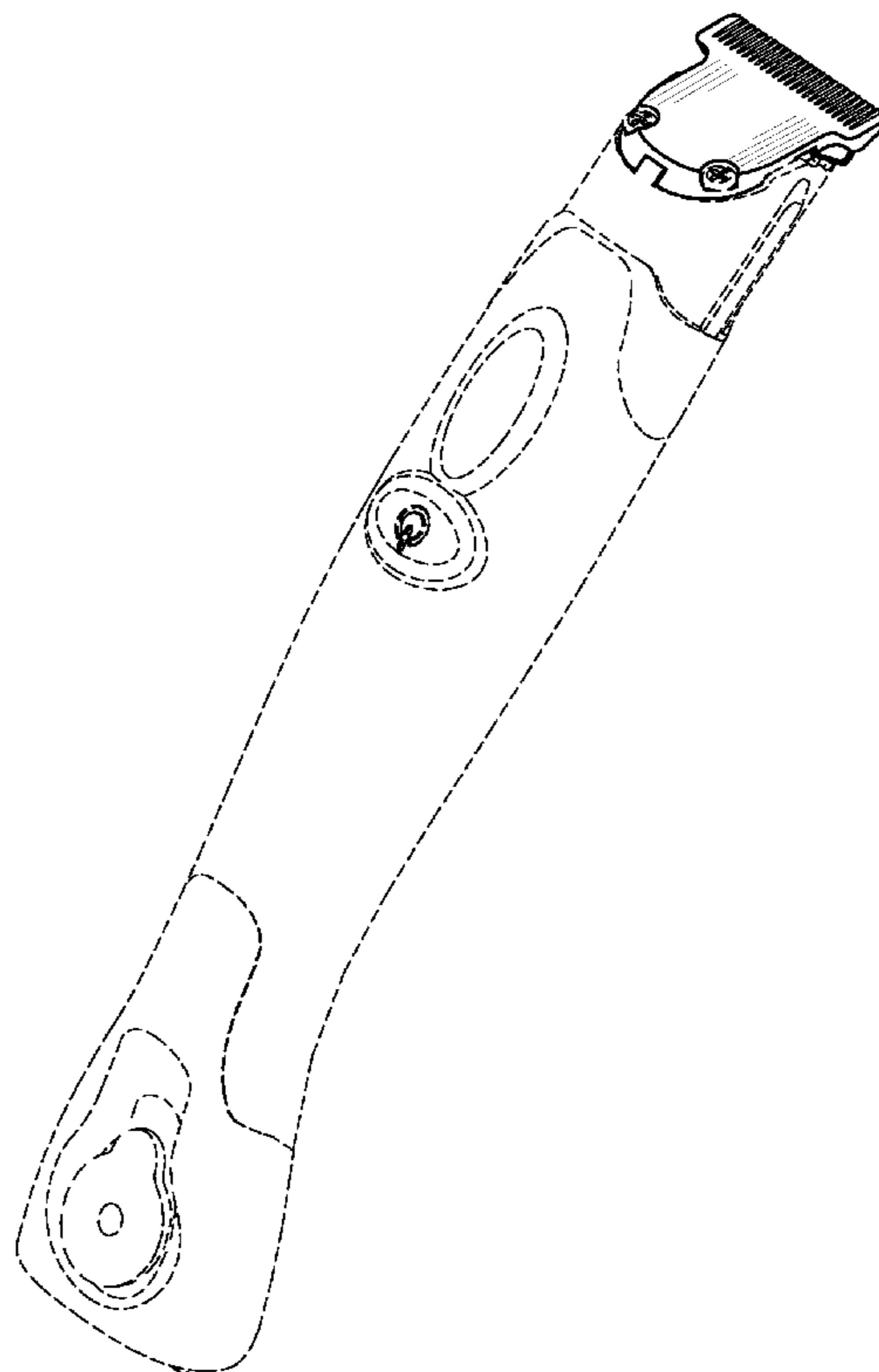
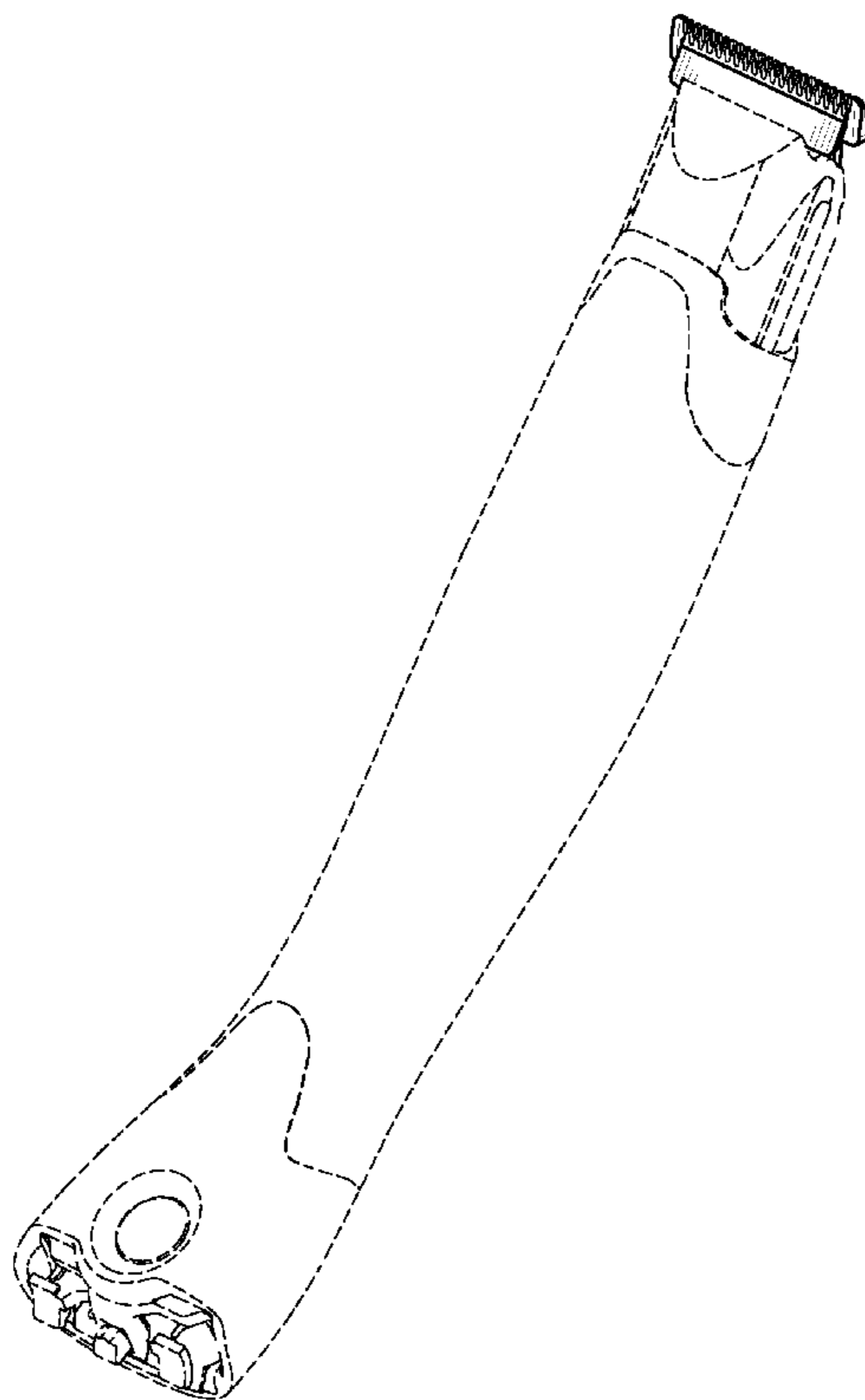

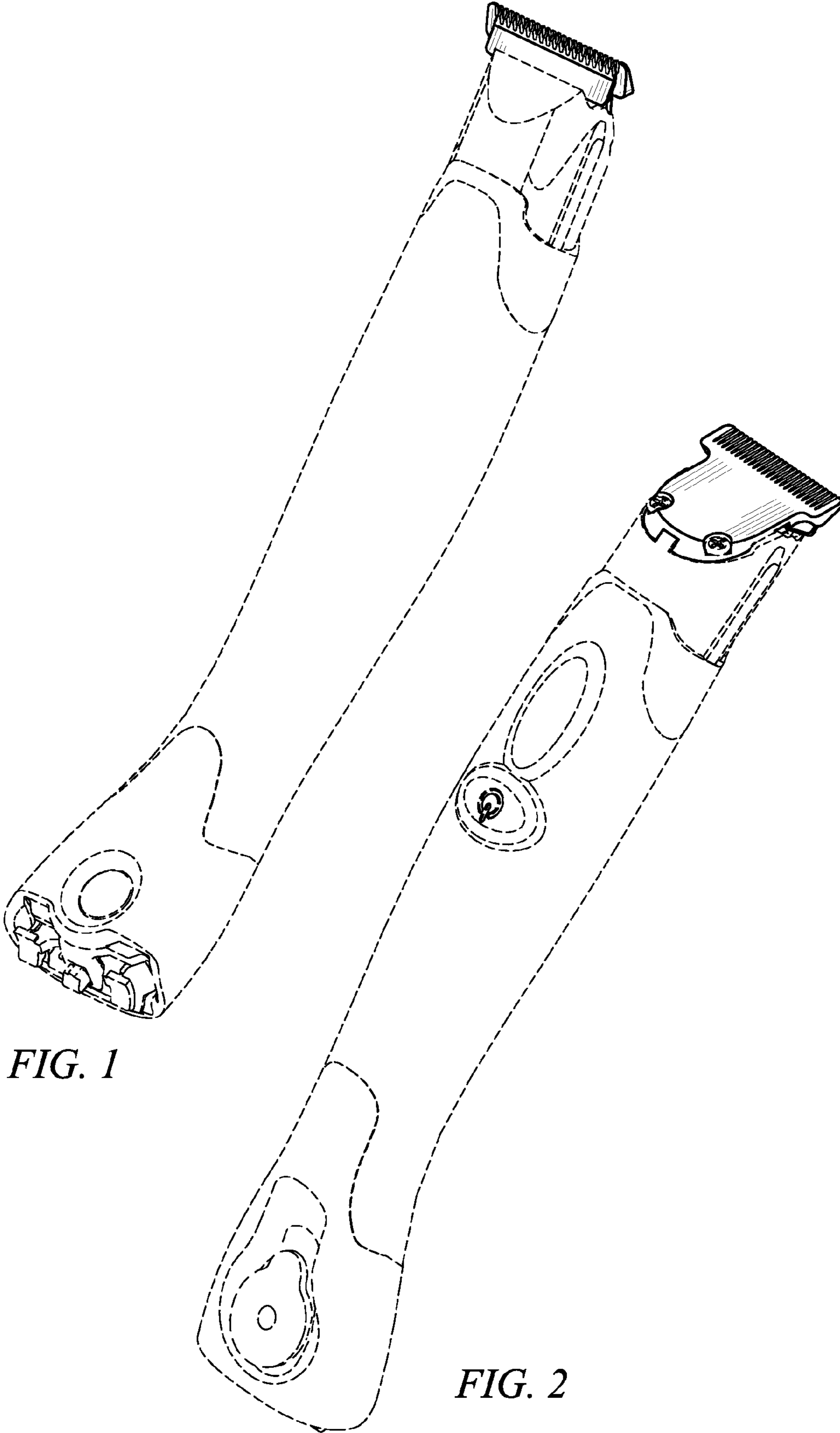

FIG. 1

FIG. 2

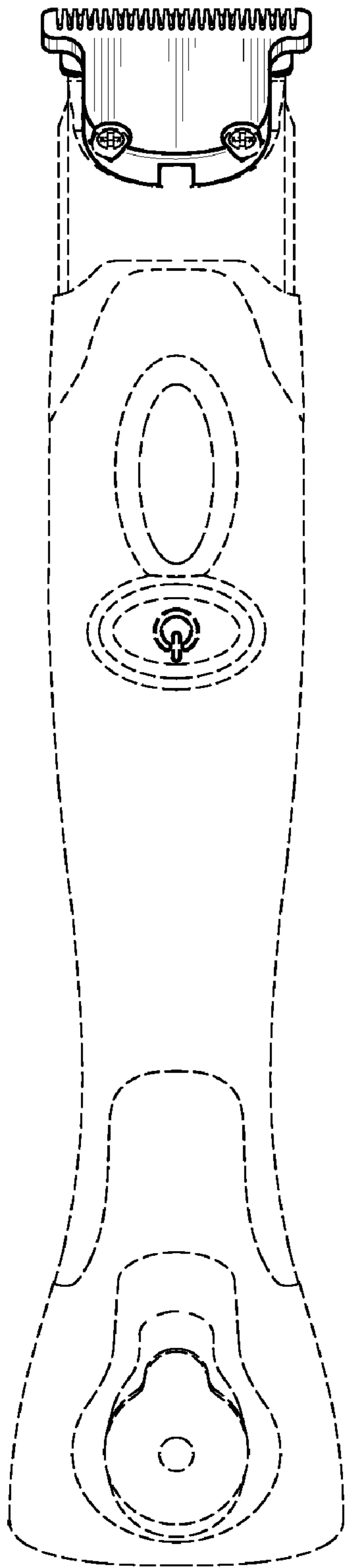

FIG. 3

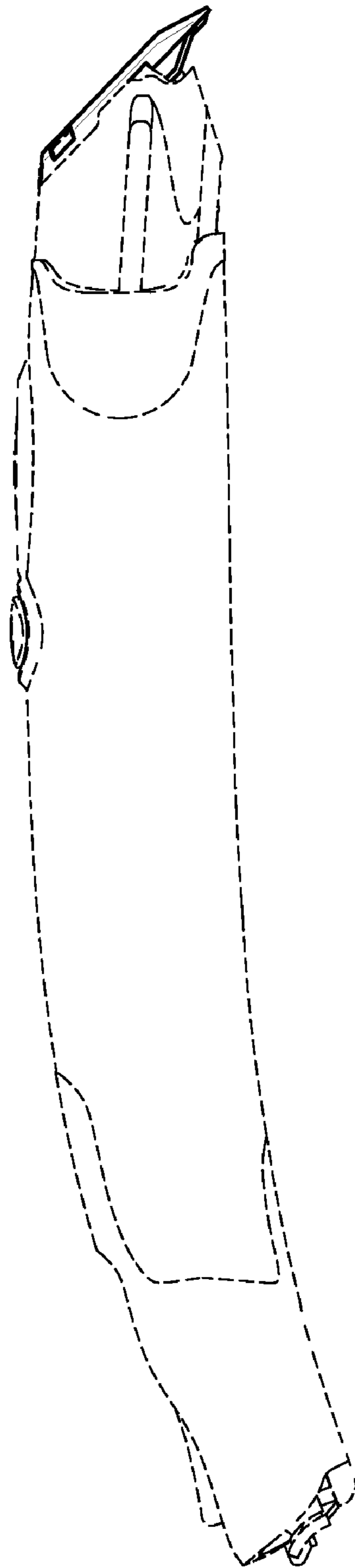

FIG. 4

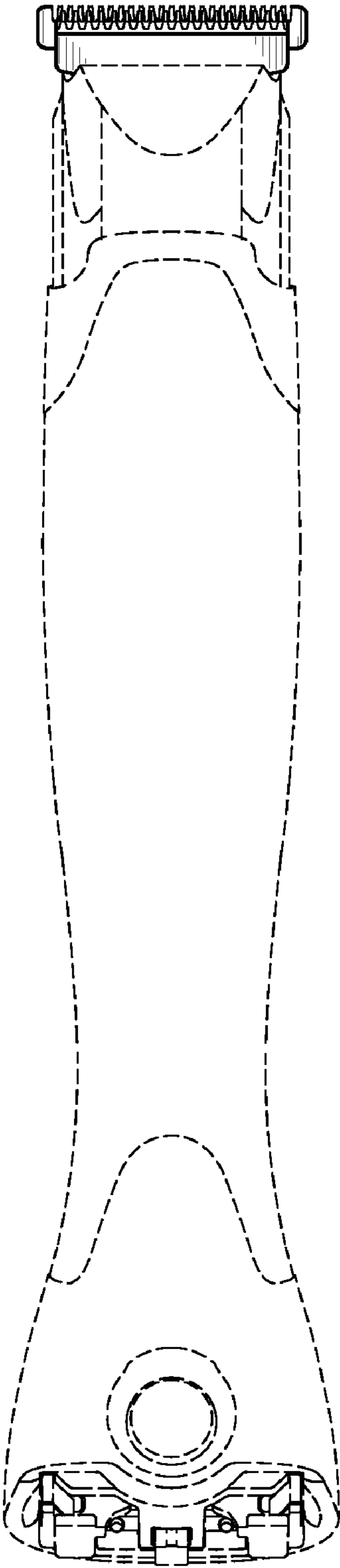

FIG. 5

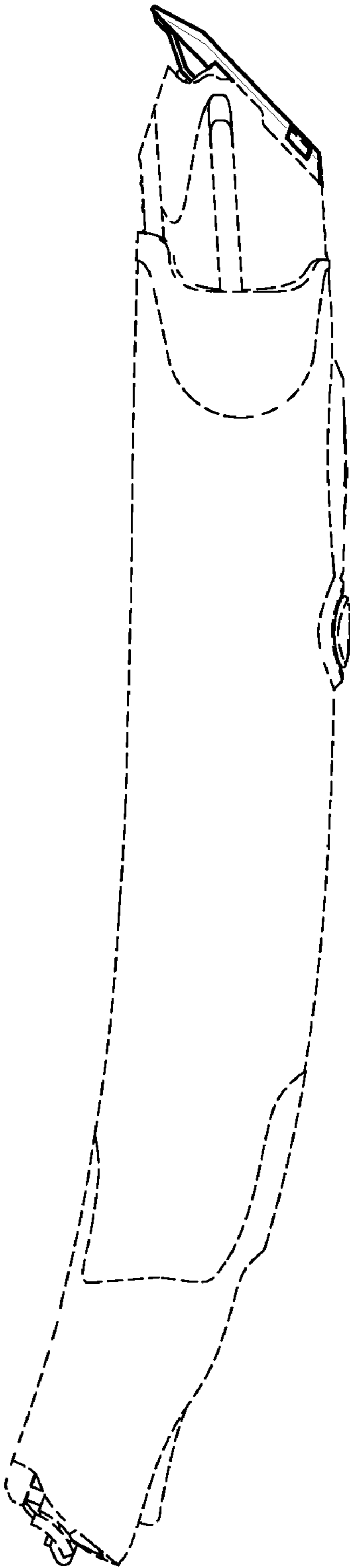

FIG. 6

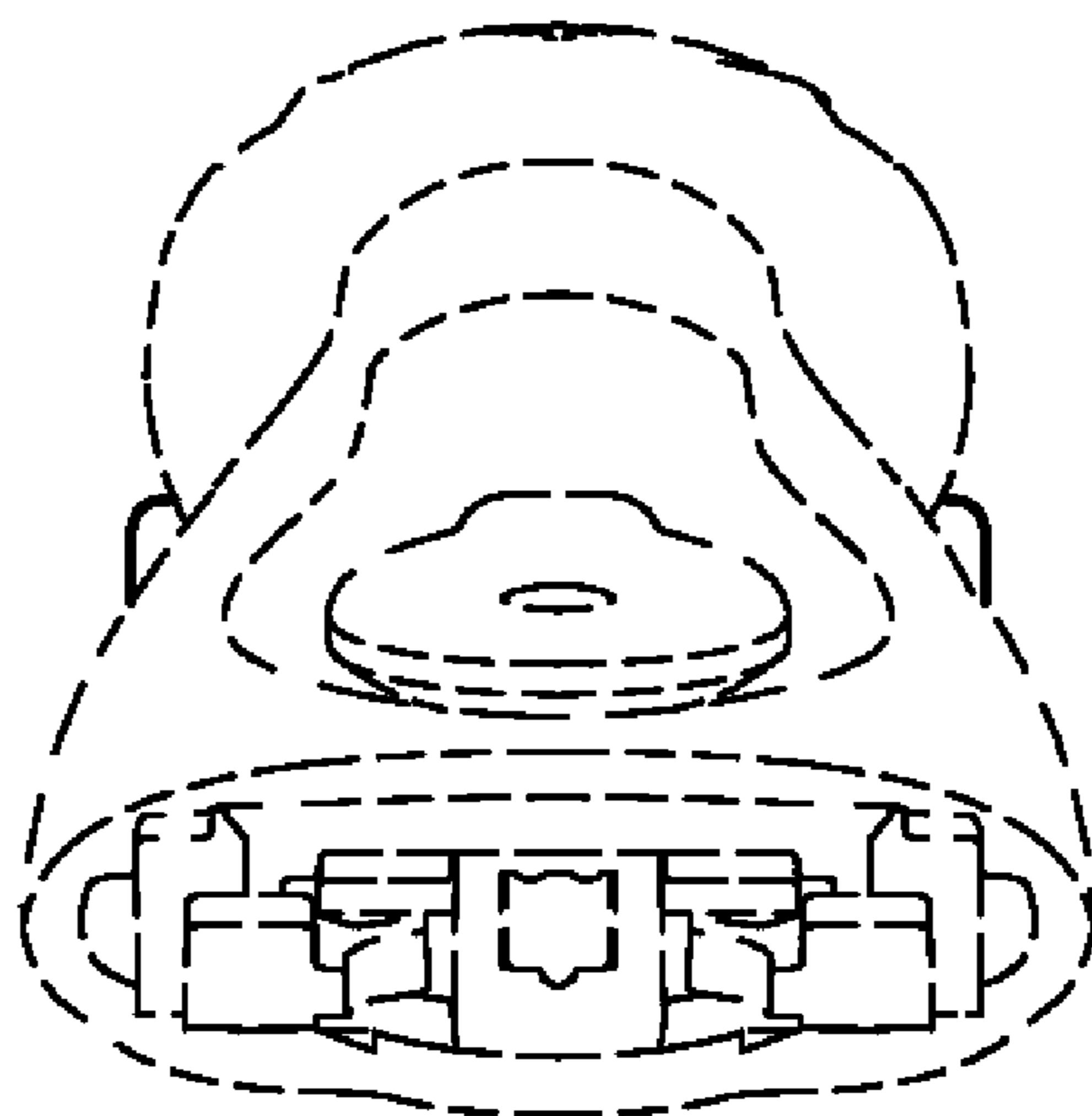

FIG. 7

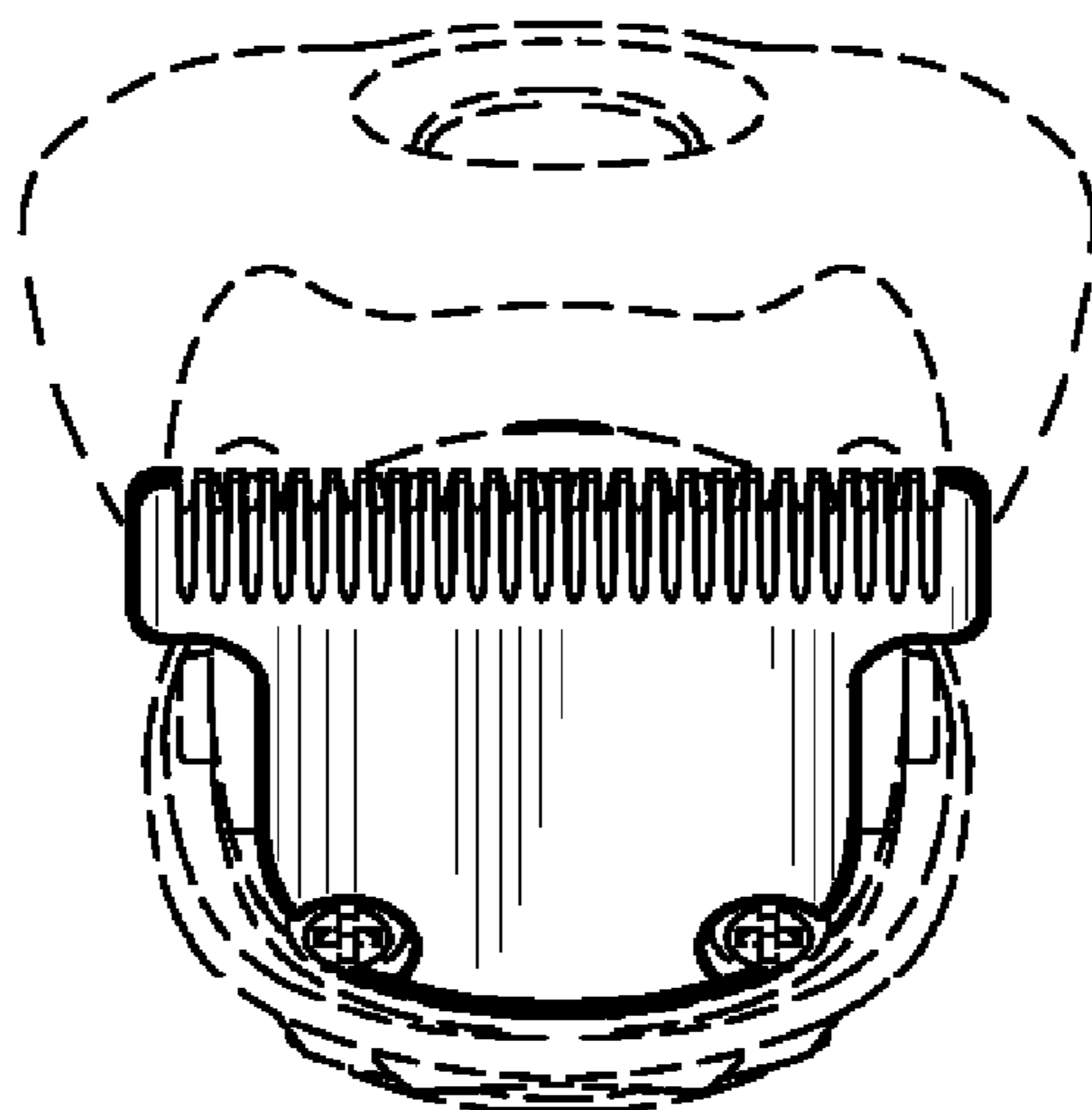

FIG. 8