



US00D617766S

(12) **United States Design Patent**  
**Katori et al.**

(10) **Patent No.:** **US D617,766 S**  
(45) **Date of Patent:** **\*\* Jun. 15, 2010**

(54) **TELEPHONE**

(75) Inventors: **Takehito Katori**, Osaka (JP); **Junichi Ogawa**, Osaka (JP)

(73) Assignee: **Panasonic Corporation**, Osaka (JP)

(\*\*) Term: **14 Years**

(21) Appl. No.: **29/345,704**

(22) Filed: **Oct. 21, 2009**

(51) **LOC (9) Cl.** ..... **14-03**

(52) **U.S. Cl.** ..... **D14/149**

(58) **Field of Classification Search** ..... D14/130,  
D14/140, 140.1, 140.8, 141.1, 141.3, 142,  
D14/149-151, 158-159, 168, 171-172, 188,  
D14/211, 214, 225-226, 240, 243, 251, 253,  
D14/299, 336, 215, 167, 210, 212, 509, 140.4,  
D14/140.5, 140.6, 242, 140.2, 138 R, 144,  
D14/434, 148; 379/387.01, 388.02, 420.02,  
379/447, 453, 434; 381/16; D13/107-108,  
D13/168; 455/351, 412.1

See application file for complete search history.

(56) **References Cited**

**U.S. PATENT DOCUMENTS**

D279,289 S \* 6/1985 Bhat et al. .... D14/149  
4,790,007 A \* 12/1988 Richter et al. .... 379/428.01

(Continued)

**OTHER PUBLICATIONS**

Panasonic KX-TG6411T, <URL:http://www2.panasonic.com/consumer-electronics/shop/Phones-Fax/Telephones/DECT-6-0-Phones/model.KX-TG6411T\_11002\_700000000000005702>, retrieved from internet Feb. 26, 20010.\*

(Continued)

*Primary Examiner*—Robert M Spear

*Assistant Examiner*—Carla Jobe Wright

(74) *Attorney, Agent, or Firm*—Brinks Hofer Gilson & Lione

(57) **CLAIM**

We claim the ornamental design for a telephone, as shown and described.

**DESCRIPTION**

FIG. 1 is a top and front perspective view of a first embodiment of a telephone of the present invention;

FIG. 2 is a front view thereof;

FIG. 3 is a rear view thereof;

FIG. 4 is a first side view thereof;

FIG. 5 is a second side view thereof;

FIG. 6 is a top view thereof;

FIG. 7 is a bottom view thereof;

FIG. 8 is a top and front perspective view thereof shown in an environment of use;

FIG. 9 is a bottom and rear perspective view thereof;

FIG. 10 is a top and front perspective view of a second embodiment of a telephone of the present invention;

FIG. 11 is a front view thereof;

FIG. 12 is a rear view thereof;

FIG. 13 is a first side view thereof;

FIG. 14 is a second side view thereof;

FIG. 15 is a top view thereof;

FIG. 16 is a bottom view thereof;

FIG. 17 is a top and front perspective view thereof shown in an environment of use; and,

FIG. 18 is a bottom and rear perspective view thereof.

In the drawing, the broken lines depict unclaimed environment. The unshaded top portion of the telephone is not part of the claimed design.

**1 Claim, 18 Drawing Sheets**

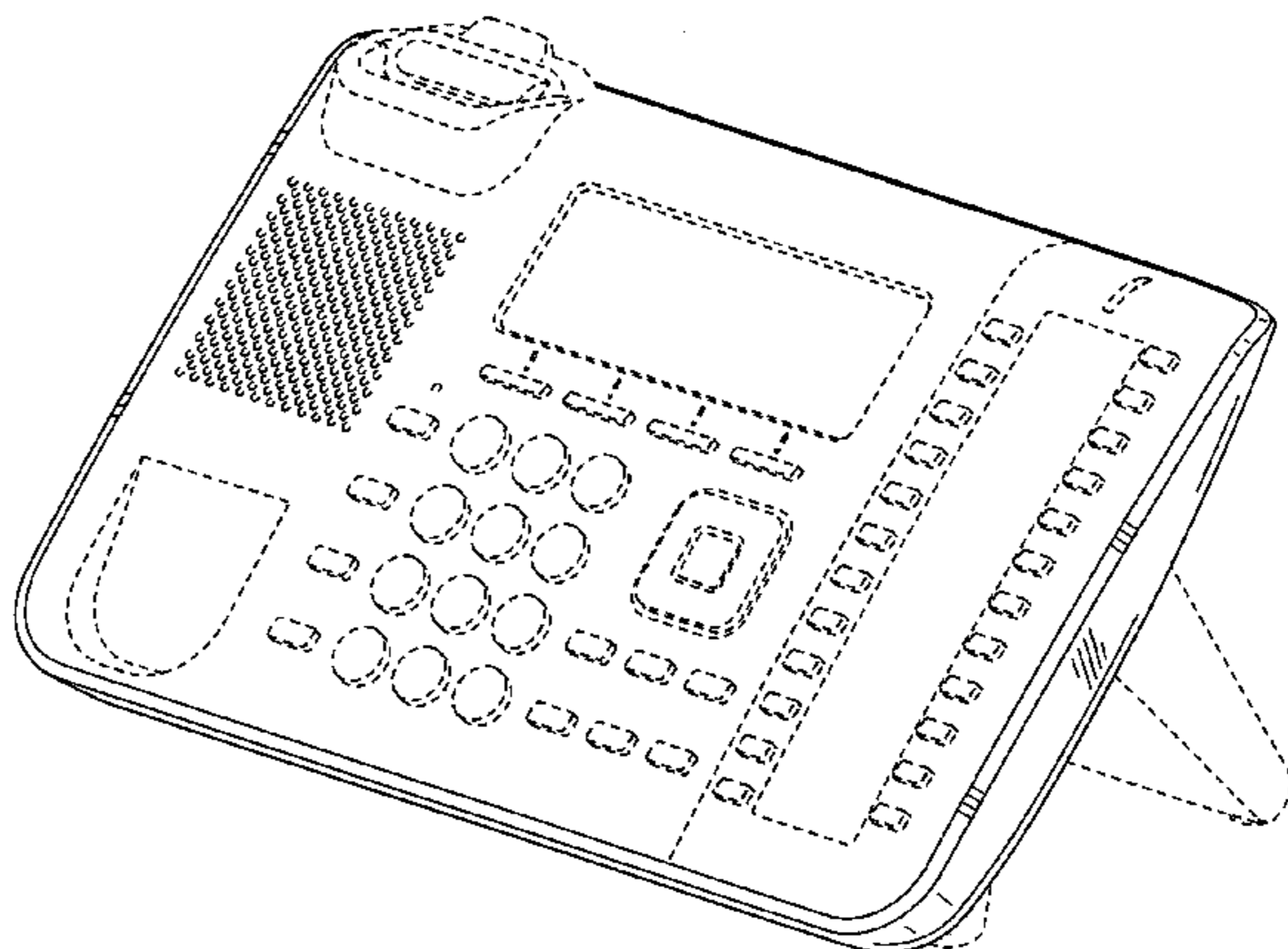
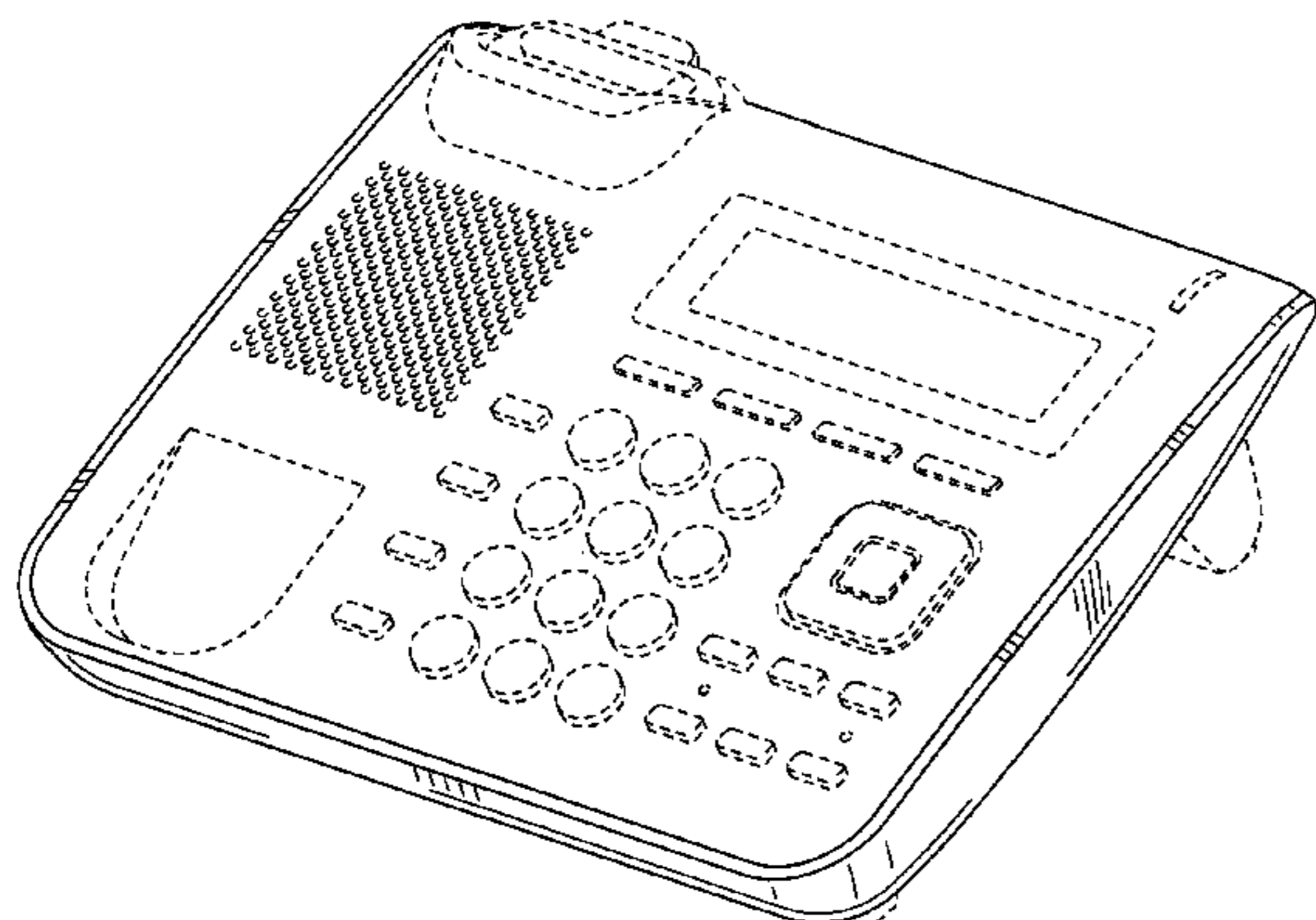

# US D617,766 S

Page 2

## U.S. PATENT DOCUMENTS

D307,008 S \* 4/1990 Shaanan et al. .... D14/151  
D357,915 S \* 5/1995 Hillenmayer ..... D14/151  
D375,741 S \* 11/1996 Mo ..... D14/151  
D386,759 S \* 11/1997 Elkins et al. .... D14/151  
D389,831 S \* 1/1998 Muller ..... D14/149  
D414,490 S \* 9/1999 Heinen et al. .... D14/148  
D427,985 S \* 7/2000 Takayama et al. .... D14/151  
D469,074 S \* 1/2003 Muenscher et al. .... D14/149  
D518,039 S 3/2006 Geringer  
D528,979 S \* 9/2006 Franck et al. .... D13/108  
D532,779 S 11/2006 Kim et al.  
D539,264 S 3/2007 Kim et al.  
D551,653 S 9/2007 Nohara  
D552,071 S 10/2007 Park et al.  
D553,605 S \* 10/2007 Chou ..... D14/151  
D557,244 S 12/2007 Lee et al.  
D558,730 S \* 1/2008 Nakashima ..... D14/151  
D558,763 S 1/2008 Morganstern et al.  
D558,834 S 1/2008 Au Yeung  
D561,198 S 2/2008 Zhang  
D566,710 S 4/2008 Chun et al.  
D567,254 S 4/2008 Lee  
D570,324 S \* 6/2008 Furuno et al. .... D14/149  
D571,775 S \* 6/2008 Waterman et al. .... D14/148

D576,997 S \* 9/2008 Furuno et al. .... D14/149  
D581,897 S \* 12/2008 Katori ..... D14/151  
D582,383 S \* 12/2008 Hasegawa et al. .... D14/149  
D596,611 S \* 7/2009 Hasegawa et al. .... D14/149  
D597,061 S \* 7/2009 Akatsu et al. .... D14/151  
D599,323 S 9/2009 Petersen  
D601,112 S 9/2009 Tang

## OTHER PUBLICATIONS

Panasonic KX-TG1061M, <URL:[http://www2.panasonic.com/consumer-electronics/shop/Phones-Fax/Telephones/DECT-6-0-Phones/model.KX-TG1061M\\_11002\\_700000000000005702](http://www2.panasonic.com/consumer-electronics/shop/Phones-Fax/Telephones/DECT-6-0-Phones/model.KX-TG1061M_11002_700000000000005702)>, retrieved from internet Feb. 26, 2010.\*

Panasonic KX-TG9344T, <URL:[http://www2.panasonic.com/consumer-electronics/shop/Phones-Fax/Telephones/DECT-6-0-Phones/model.KX-TG9344T\\_11002\\_700000000000005702](http://www2.panasonic.com/consumer-electronics/shop/Phones-Fax/Telephones/DECT-6-0-Phones/model.KX-TG9344T_11002_700000000000005702)>, retrieved from internet Feb. 26, 2010.\*

Panasonic KX-TG9333T, <URL:[http://www2.panasonic.com/consumer-electronics/shop/Phones-Fax/Telephones/DECT-6-0-Phones/model.KX-TG9333T\\_11002\\_700000000000005702](http://www2.panasonic.com/consumer-electronics/shop/Phones-Fax/Telephones/DECT-6-0-Phones/model.KX-TG9333T_11002_700000000000005702)>, retrieved from internet Feb. 26, 2010.\*

GE/RCA 27907GE1, <URL:<http://www.101phones.com/details/18512-1823/ge-rca-27907ge1.html>>, retrieved from internet Feb. 26, 2010.\*

\* cited by examiner

FIG.1

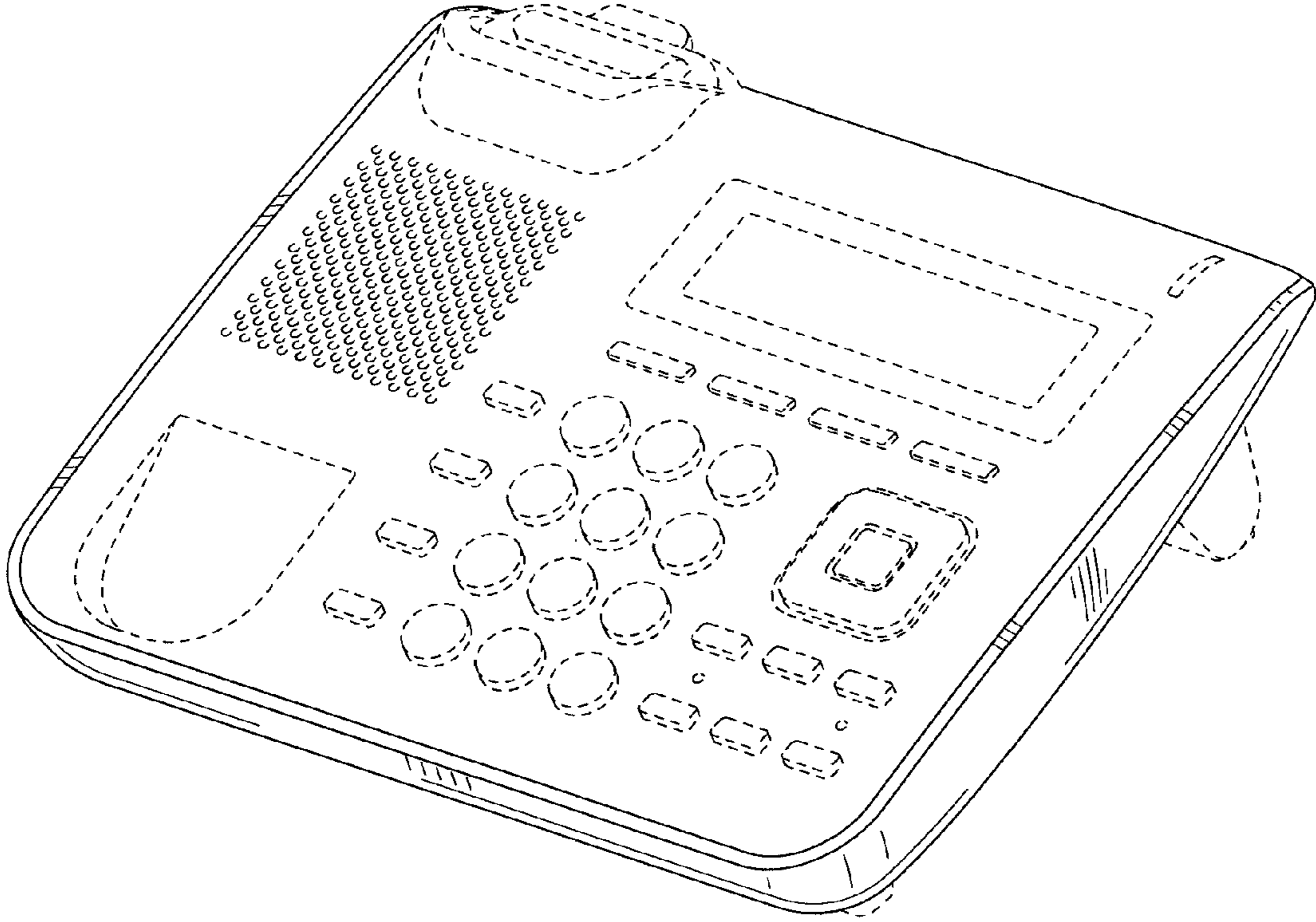

FIG.2

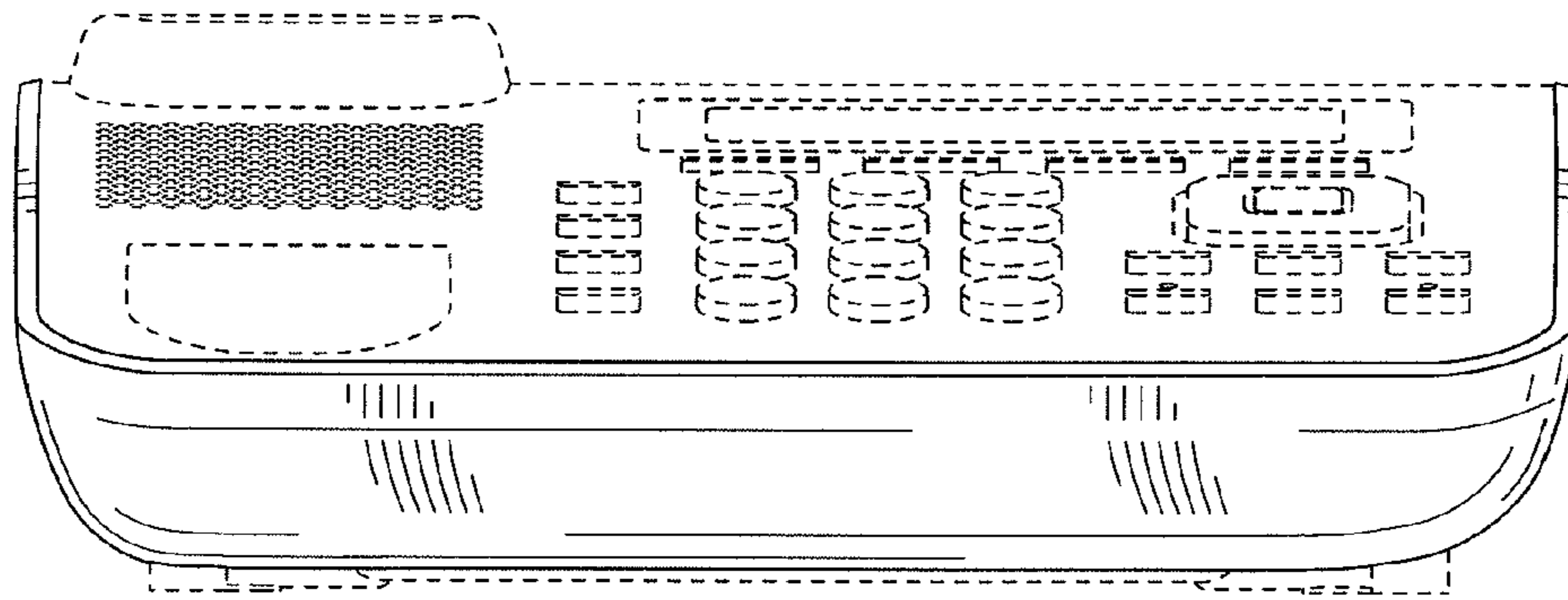

FIG.3

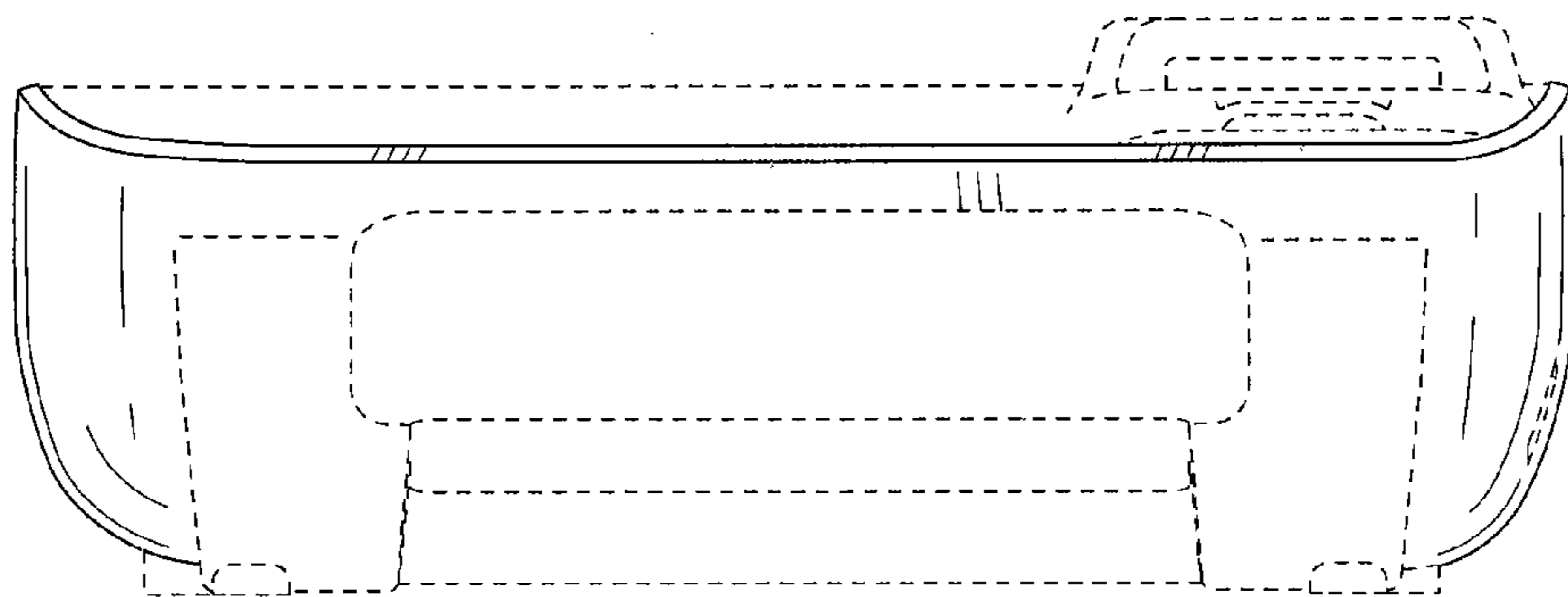

FIG.4

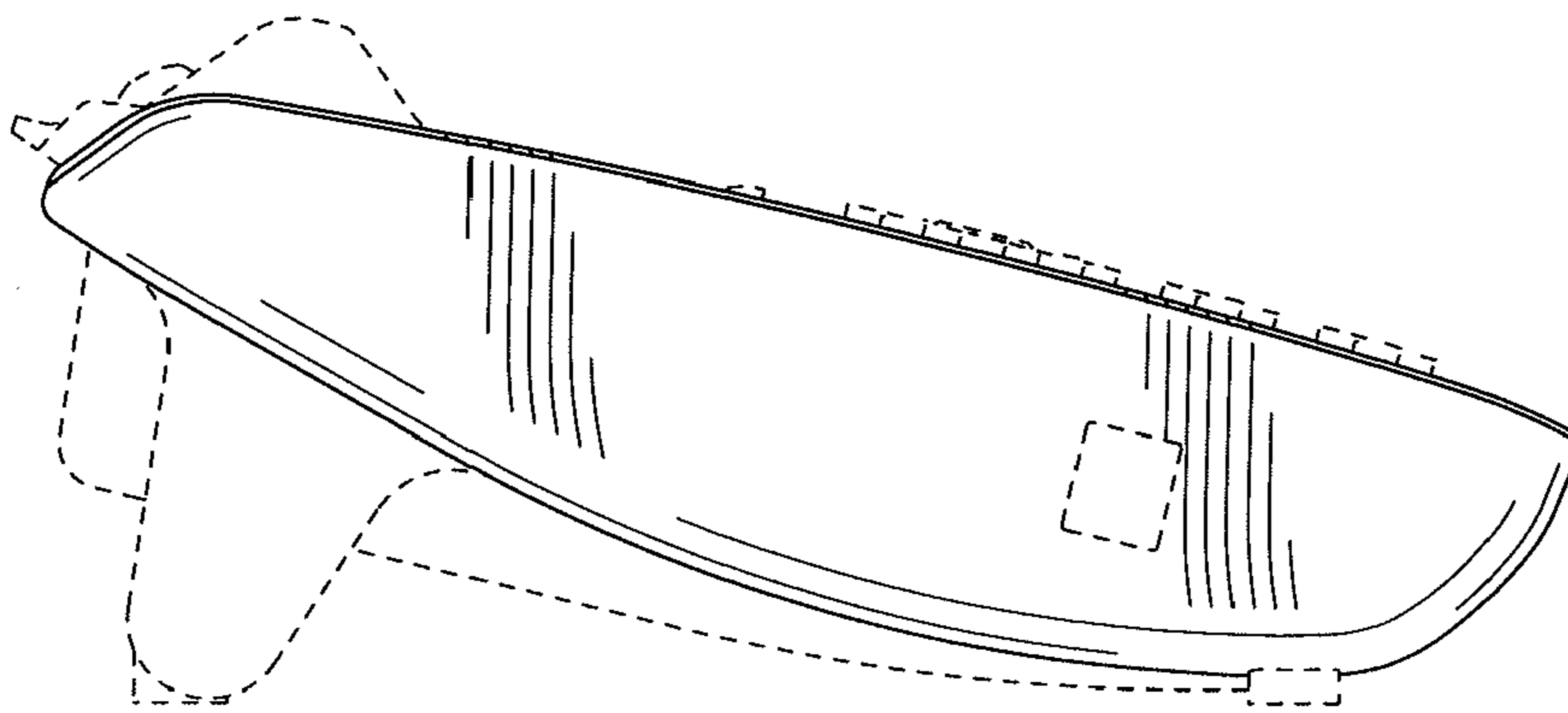

FIG.5

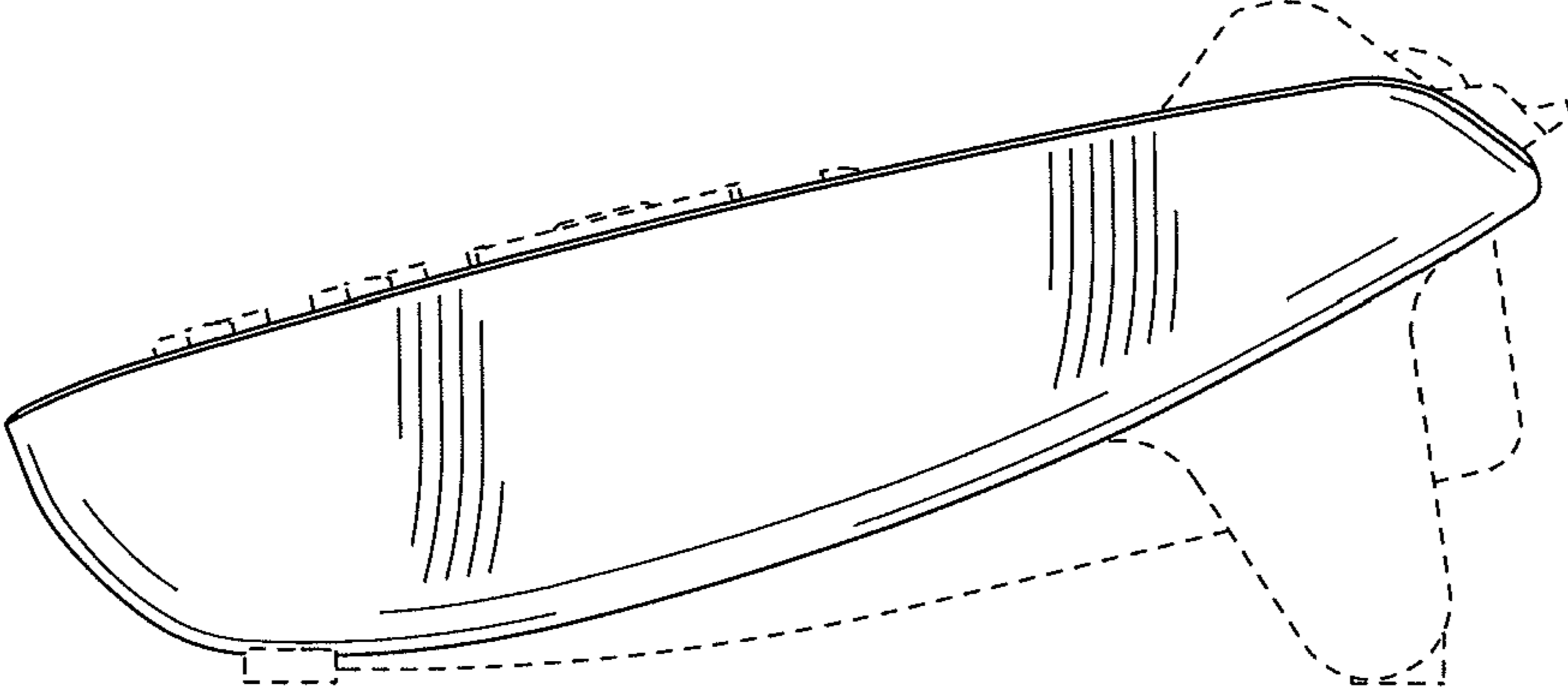

FIG.6

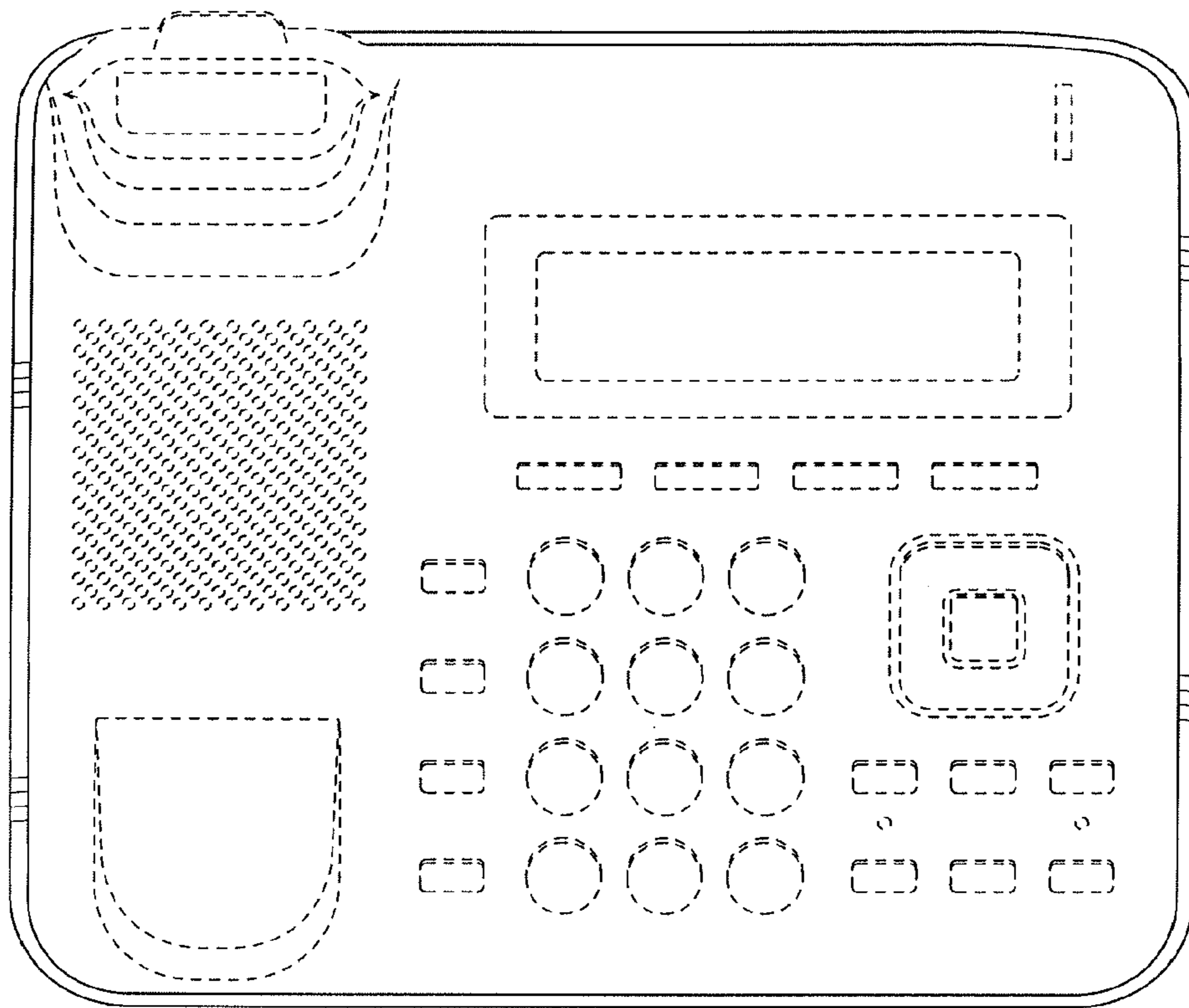



FIG.7

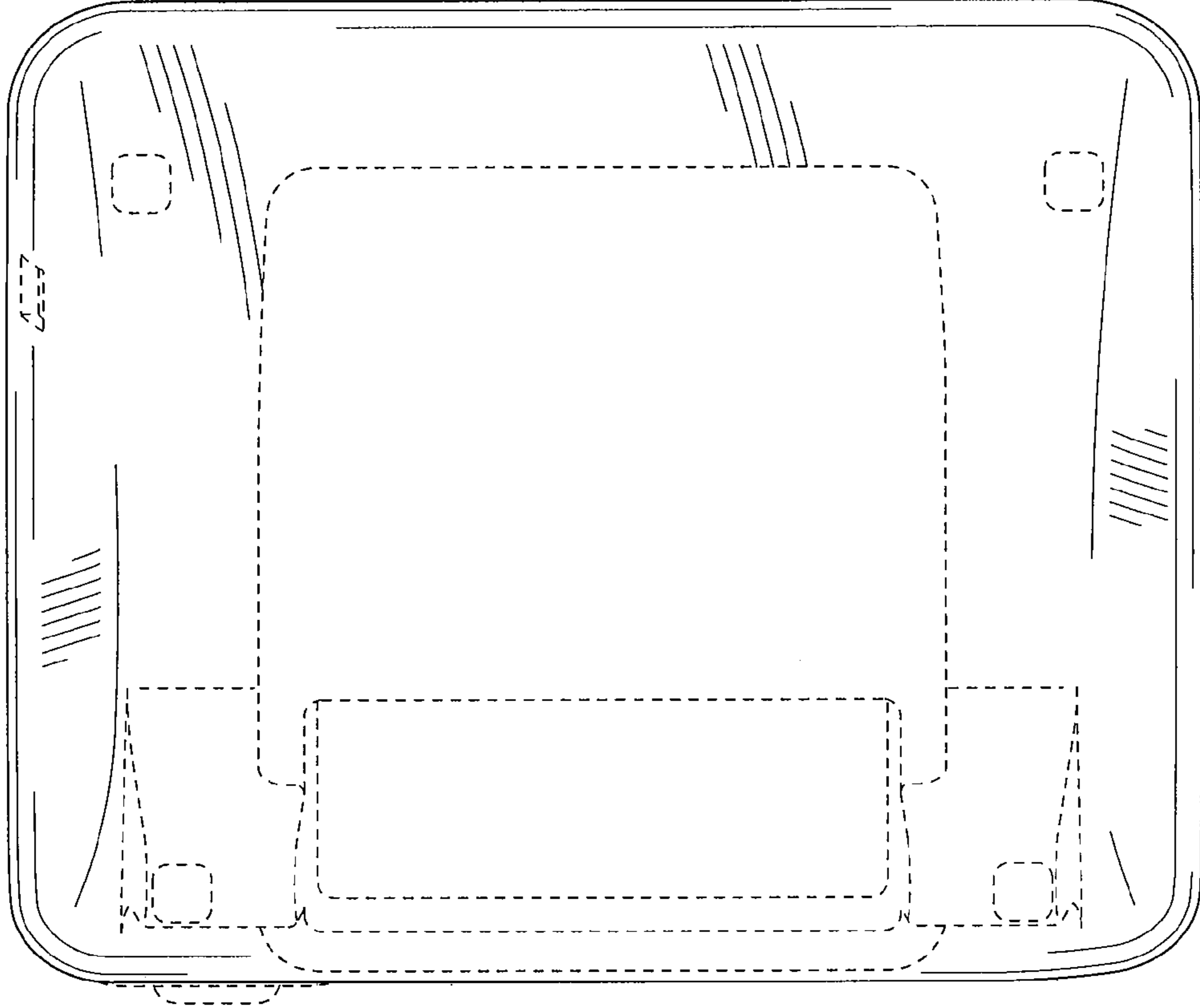

FIG. 8

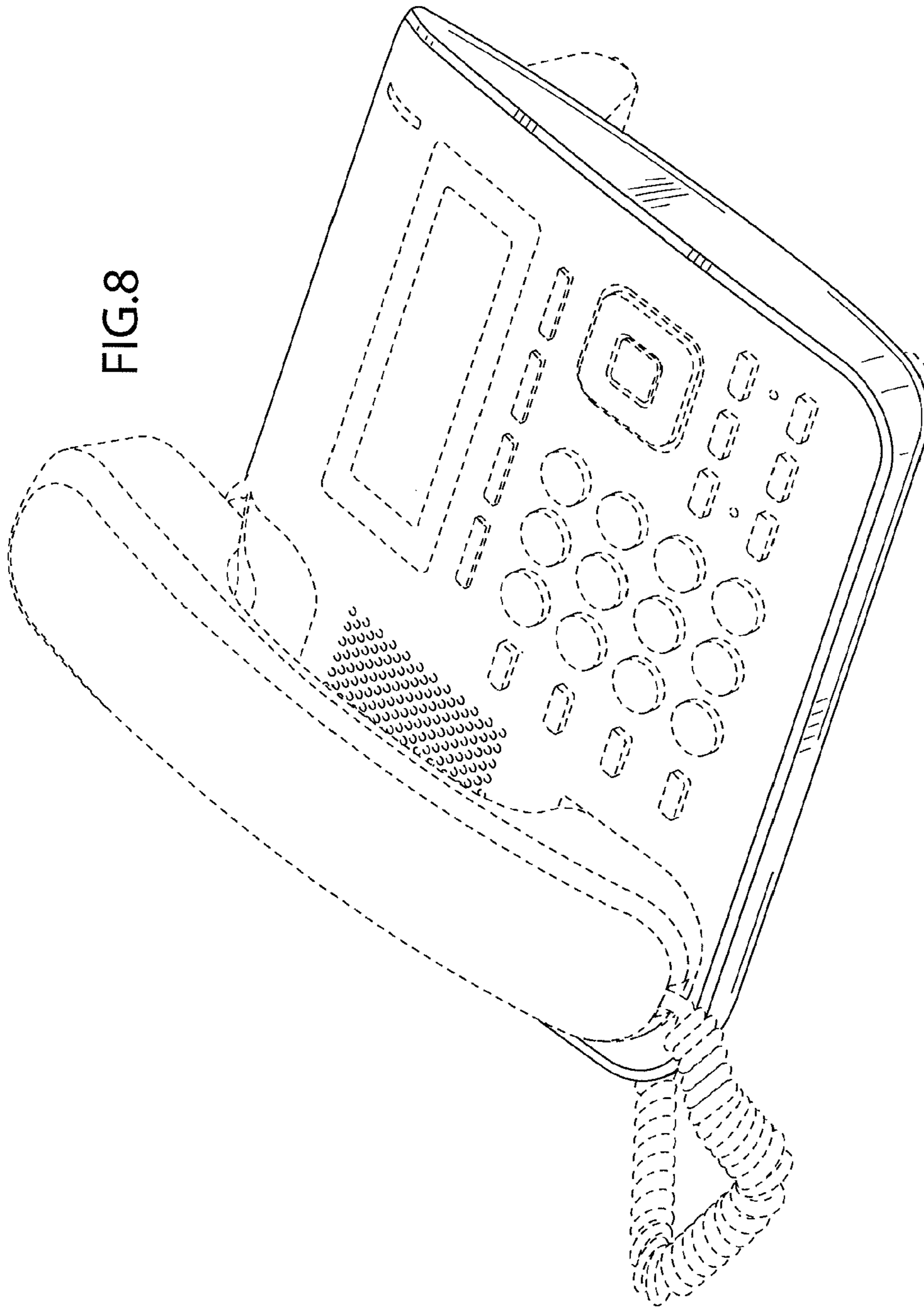

FIG.9

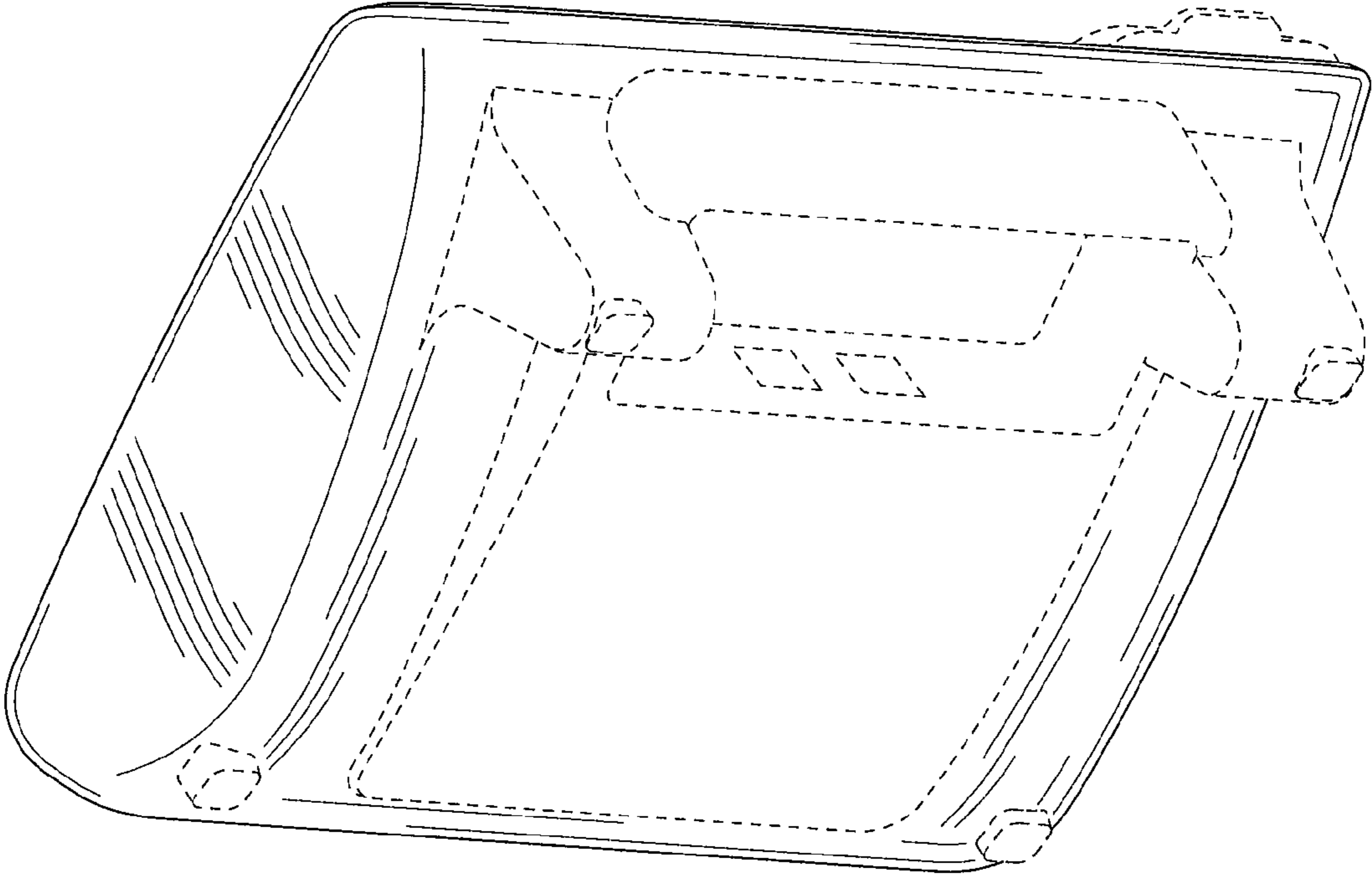

FIG.10

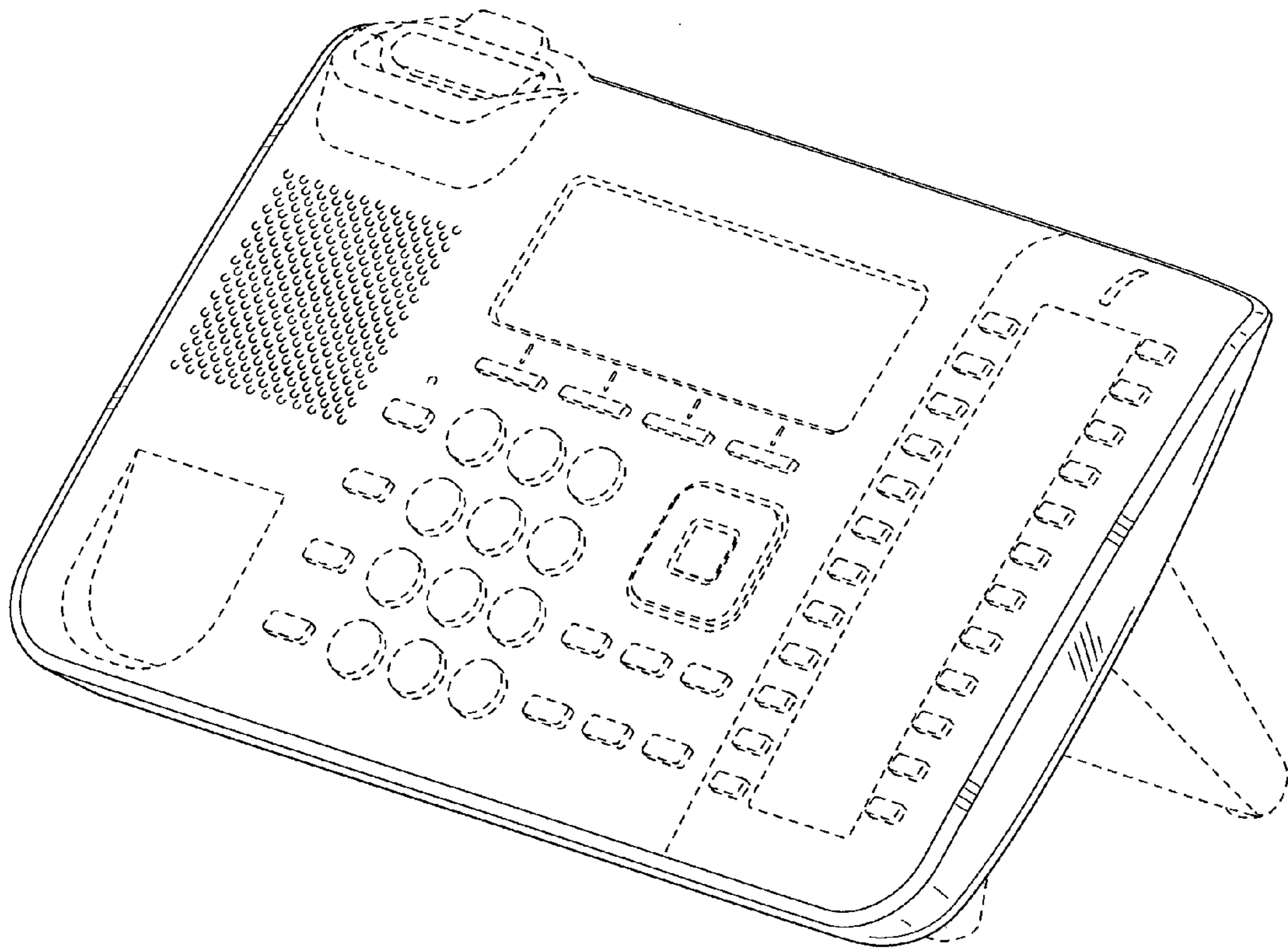

FIG.11

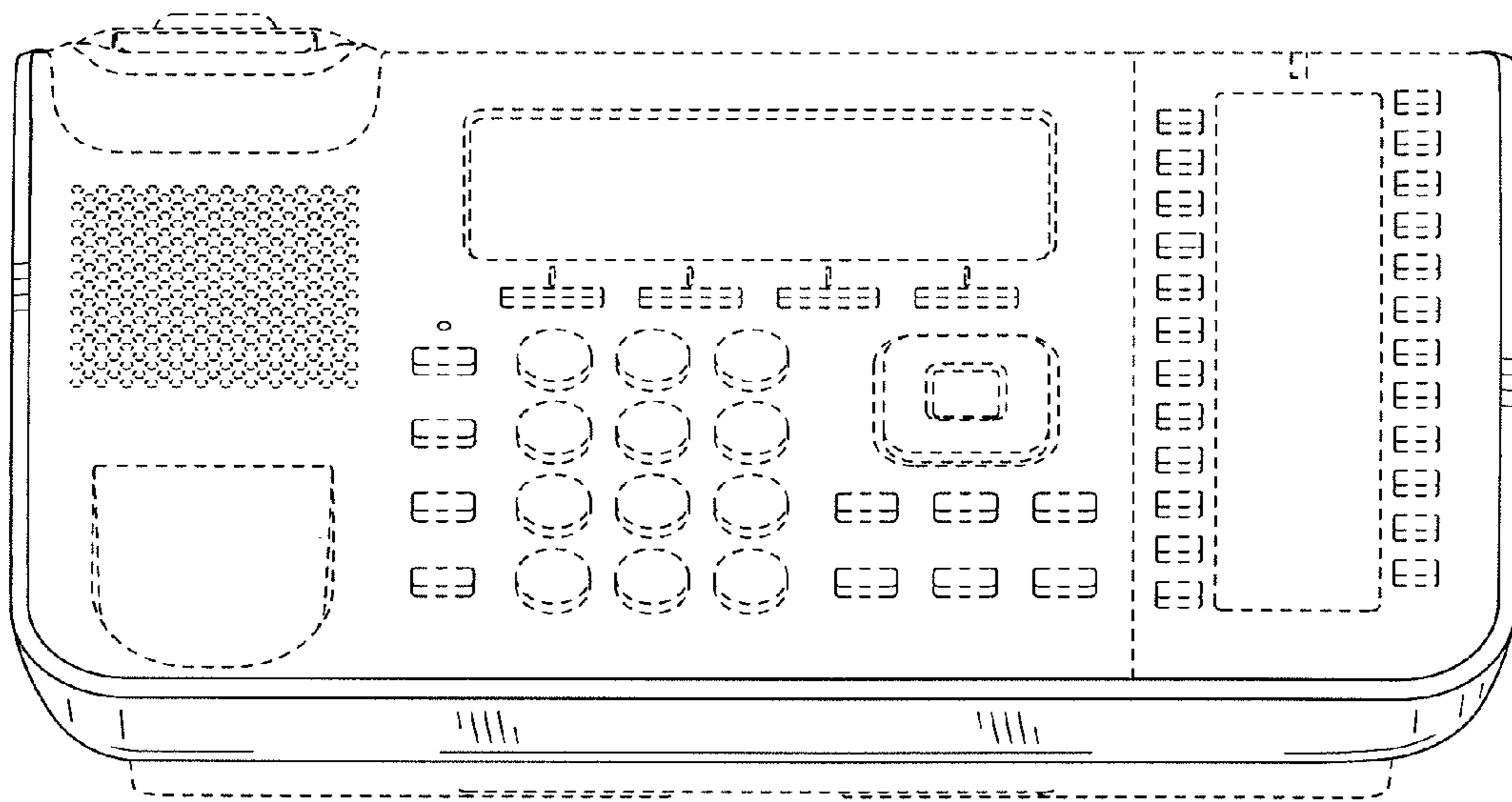

FIG.12

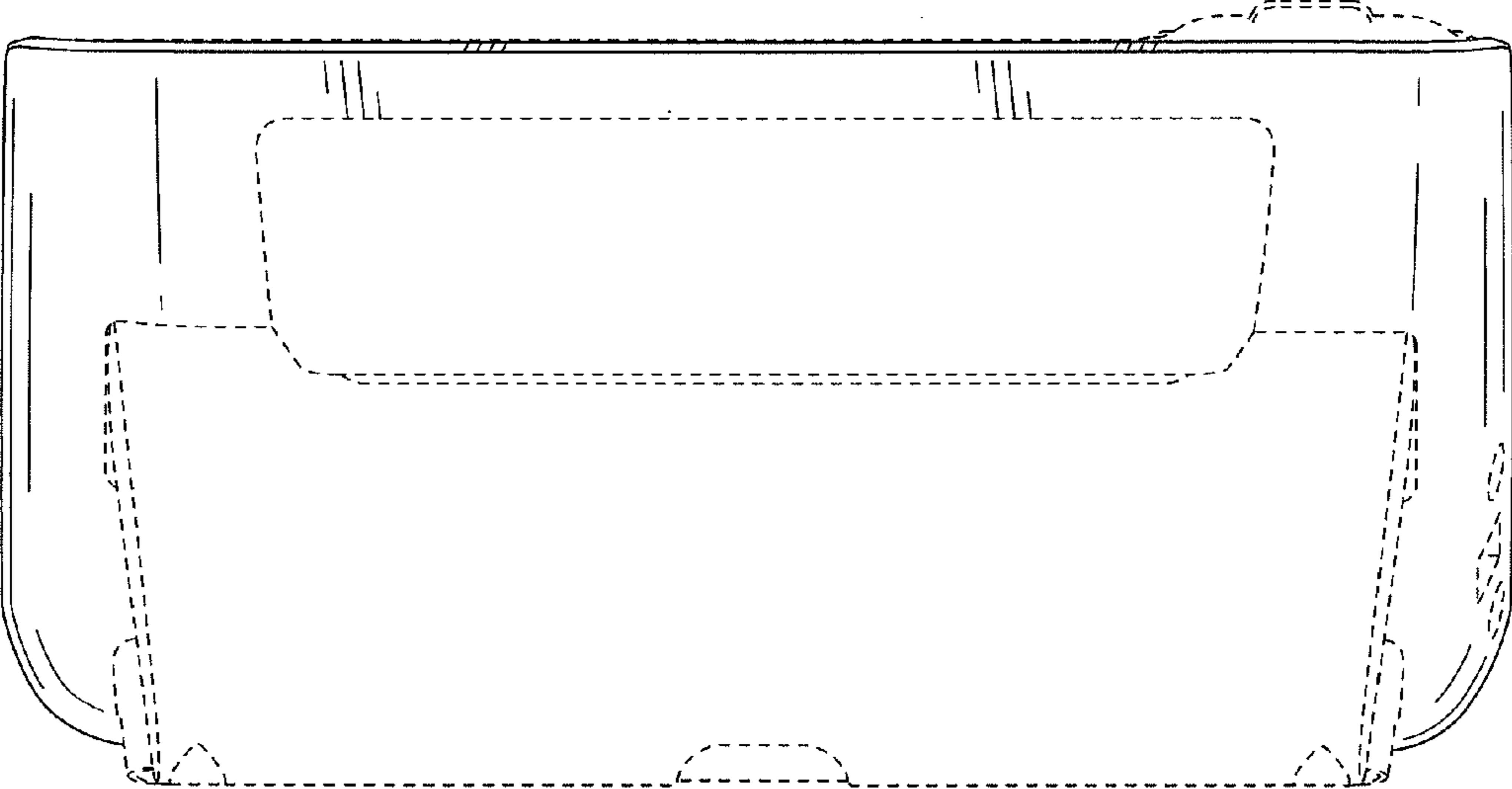

FIG.13

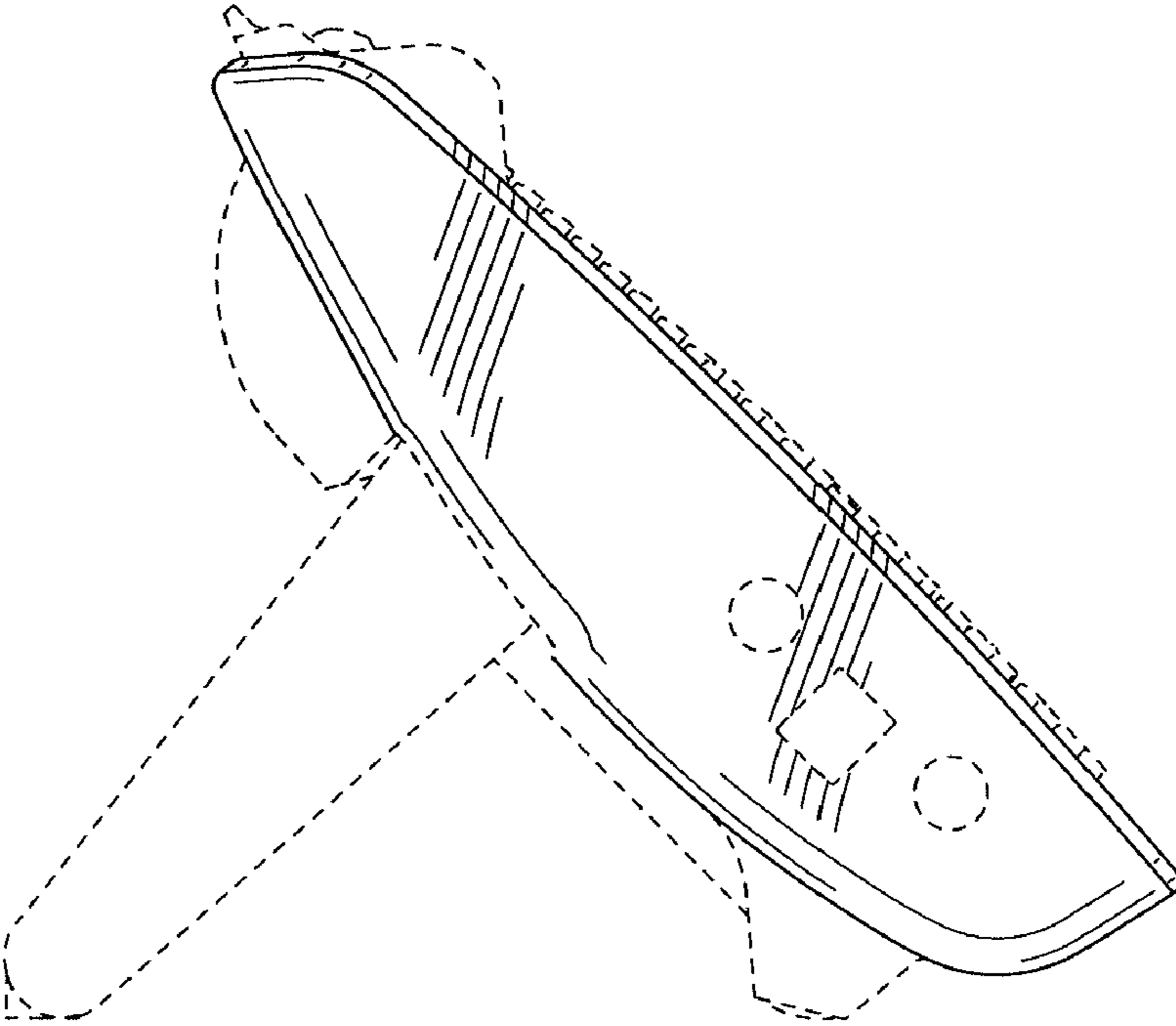

FIG.14

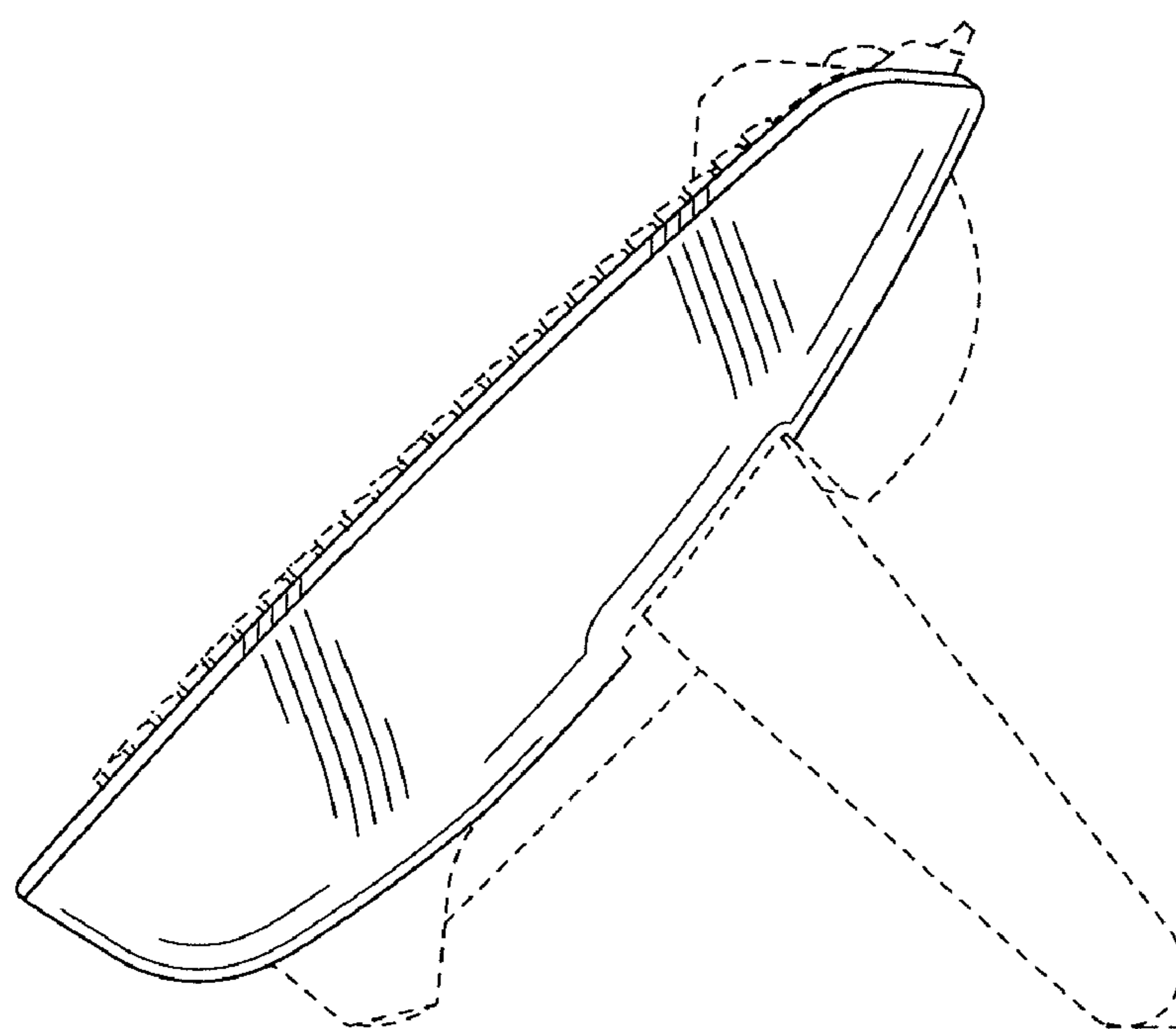



FIG.15

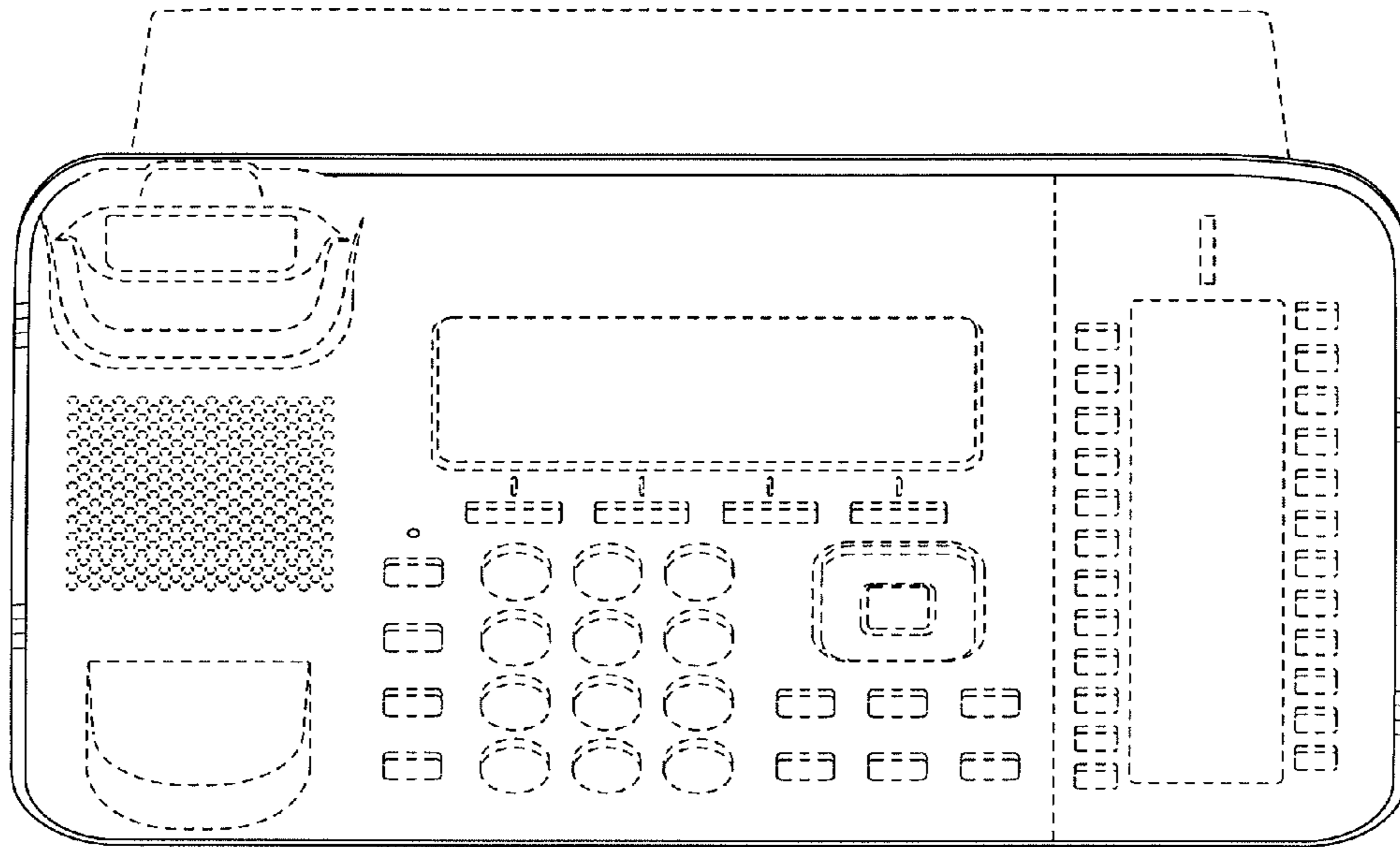

FIG.16

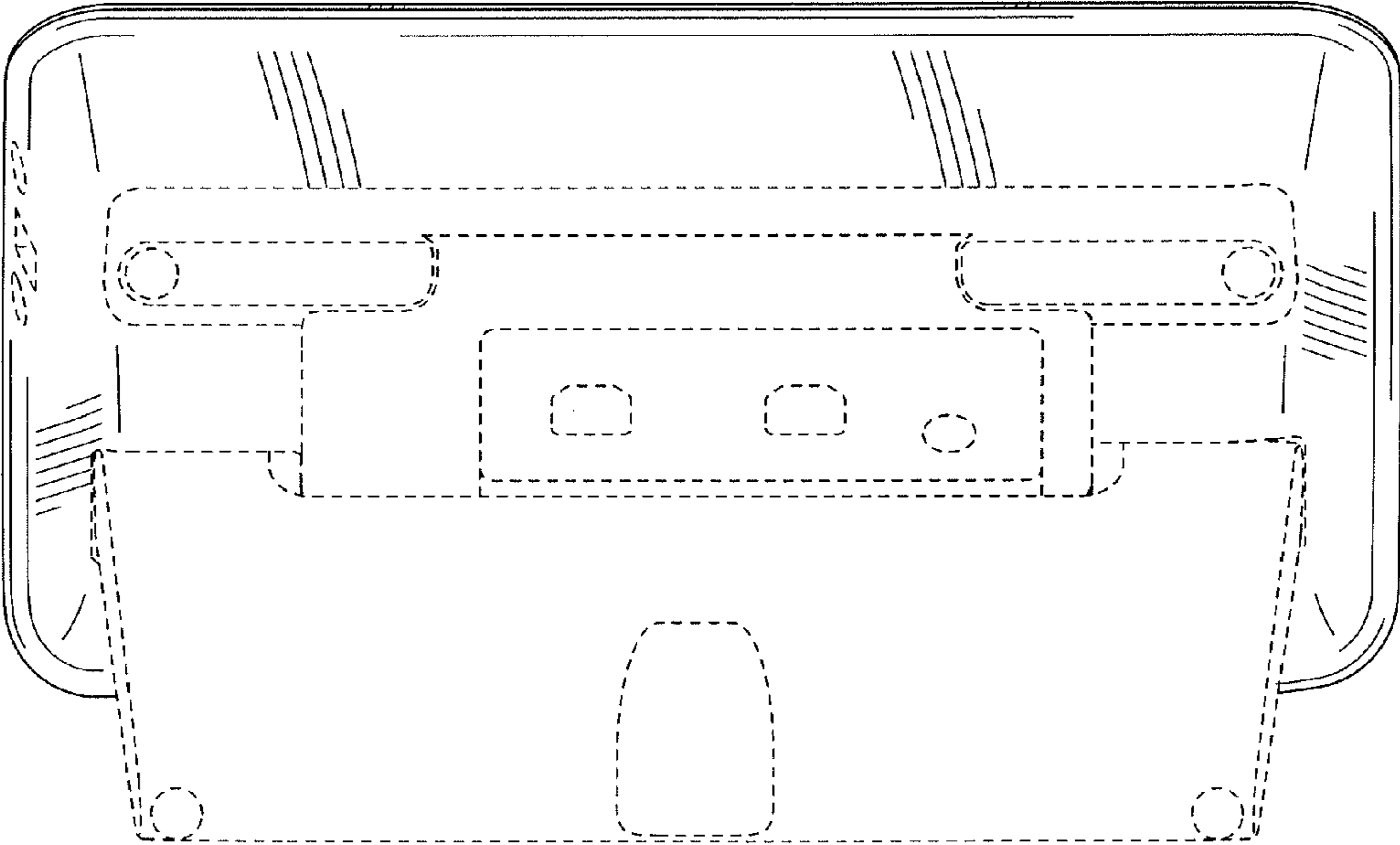

FIG.17

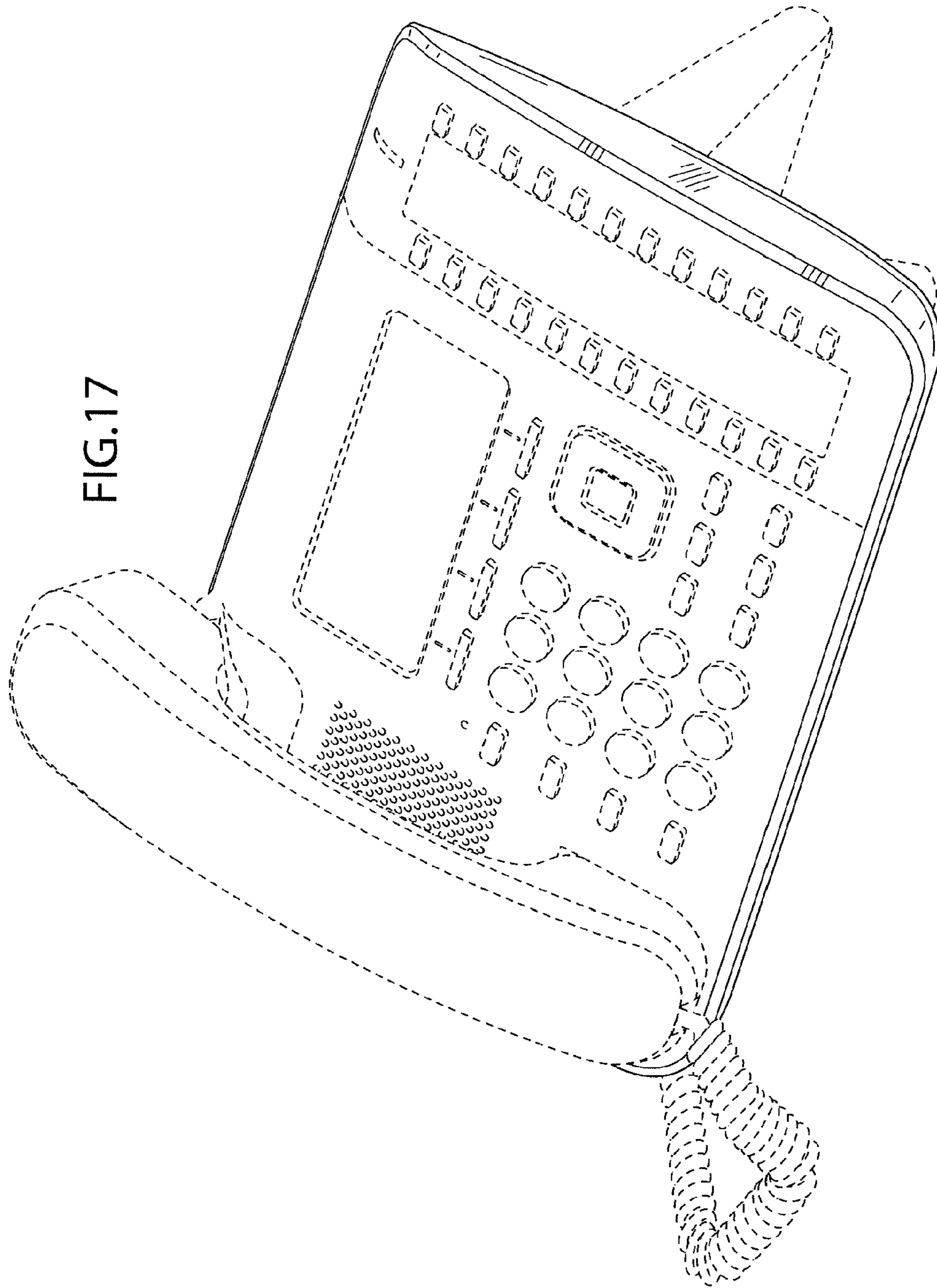

FIG.18

