



US00D617759S

(12) **United States Design Patent**
Leinvuo et al.

(10) **Patent No.:** **US D617,759 S**
(45) **Date of Patent:** **** Jun. 15, 2010**

(54) **HANDSET**

(75) Inventors: **Toni Antero Leinvuo**, London (GB);
Richard Choi, London (GB)

(73) Assignee: **Nokia Corporation**, Espoo (FI)

(**) Term: **14 Years**

(21) Appl. No.: **29/342,675**

(22) Filed: **Aug. 28, 2009**

(51) **LOC (9) Cl.** **14-03**

(52) **U.S. Cl.** **D14/138 AD**

(58) **Field of Classification Search** D14/138 R,
D14/138 AD, 138 AC, 138 C, 138 G, 191,
D14/203.1–203.8, 496, 138 AA, 138 AB,
D14/247–248, 137, 147, 218, 341–347; D10/65,
D10/78, 104; D13/168; D18/7; 455/566,
455/575.1, 575.3

See application file for complete search history.

(56) **References Cited**

U.S. PATENT DOCUMENTS

- D466,096 S * 11/2002 Takada D14/138 AD
- D511,342 S * 11/2005 Chien D14/346
- D529,474 S * 10/2006 Park et al. D14/138 AD
- D531,977 S * 11/2006 Kim et al. D14/138 AD
- D535,275 S * 1/2007 Kim et al. D14/138 AD
- D548,712 S * 8/2007 Kim et al. D14/138 AD
- D549,204 S * 8/2007 Cho D14/138 AD
- D551,646 S * 9/2007 Kim et al. D14/138 AC
- D561,781 S * 2/2008 Park D14/496
- D563,936 S * 3/2008 Kim et al. D14/138 AD
- D569,365 S * 5/2008 Shin et al. D14/138 AC
- 7,372,959 B2 * 5/2008 Ladouceur et al. 379/433.07
- D575,759 S * 8/2008 Park et al. D14/138 AD
- D578,985 S * 10/2008 Kim et al. D14/138 AD
- D591,714 S * 5/2009 Kim et al. D14/138 AD
- D597,048 S 7/2009 Bjorninen et al.
- D597,518 S 8/2009 Asmussen
- D601,994 S * 10/2009 Kim et al. D14/138 G
- D605,160 S * 12/2009 Eaton D14/138 AD
- D605,161 S * 12/2009 Eaton D14/138 AD

- D608,322 S * 1/2010 Kim D14/138 G
- 2004/0259592 A1 * 12/2004 Taneya et al. 455/556.1
- 2005/0250532 A1 * 11/2005 Hwang et al. 455/550.1
- 2007/0293286 A1 * 12/2007 Park et al. 455/575.1
- 2008/0132288 A1 * 6/2008 Misawa 455/566
- 2008/0167097 A1 * 7/2008 Ko 455/575.4
- 2009/0322691 A1 * 12/2009 Chiu 345/173

OTHER PUBLICATIONS

Asus nuvifone A50, announced Feb. 2010, [online], [retrieved on Feb. 17, 2010]. Retrieved from Internet ,<URL: <http://www.gsmarena.com>>.*

LG Incite, announced Nov. 2008, [online], [retrieved on Nov. 26, 2008]. Retrieved from Internet ,<URL: <http://www.gsmarena.com>>.*

Nokia X3, announced Sep. 2009, [online], [retrieved on Sep. 4, 2009]. Retrieved from Internet ,<URL: <http://www.gsmarena.com>>.*

* cited by examiner

Primary Examiner—Jeffrey D Asch

Assistant Examiner—Bridget L Eland

(74) *Attorney, Agent, or Firm*—Banner & Witcoff, Ltd.

(57) **CLAIM**

The ornamental design for a handset, as shown and described.

DESCRIPTION

FIG. 1 is a front perspective view of a handset showing our new design;

FIG. 2 is a front view thereof;

FIG. 3 is a rear view thereof;

FIG. 4 is a left side view thereof;

FIG. 5 is a right side view thereof;

FIG. 6 is a bottom view thereof; and,

FIG. 7 is a top view thereof.

The broken line showing in FIGS. 1, 3, 4, 5 and 6 is for illustrative purposes only and forms no part of the claimed design. The depicted contrast in shading of the two strips in FIGS. 1 and 2, represents a change in color, material, or surface texture to its immediately surrounding regions.

1 Claim, 5 Drawing Sheets

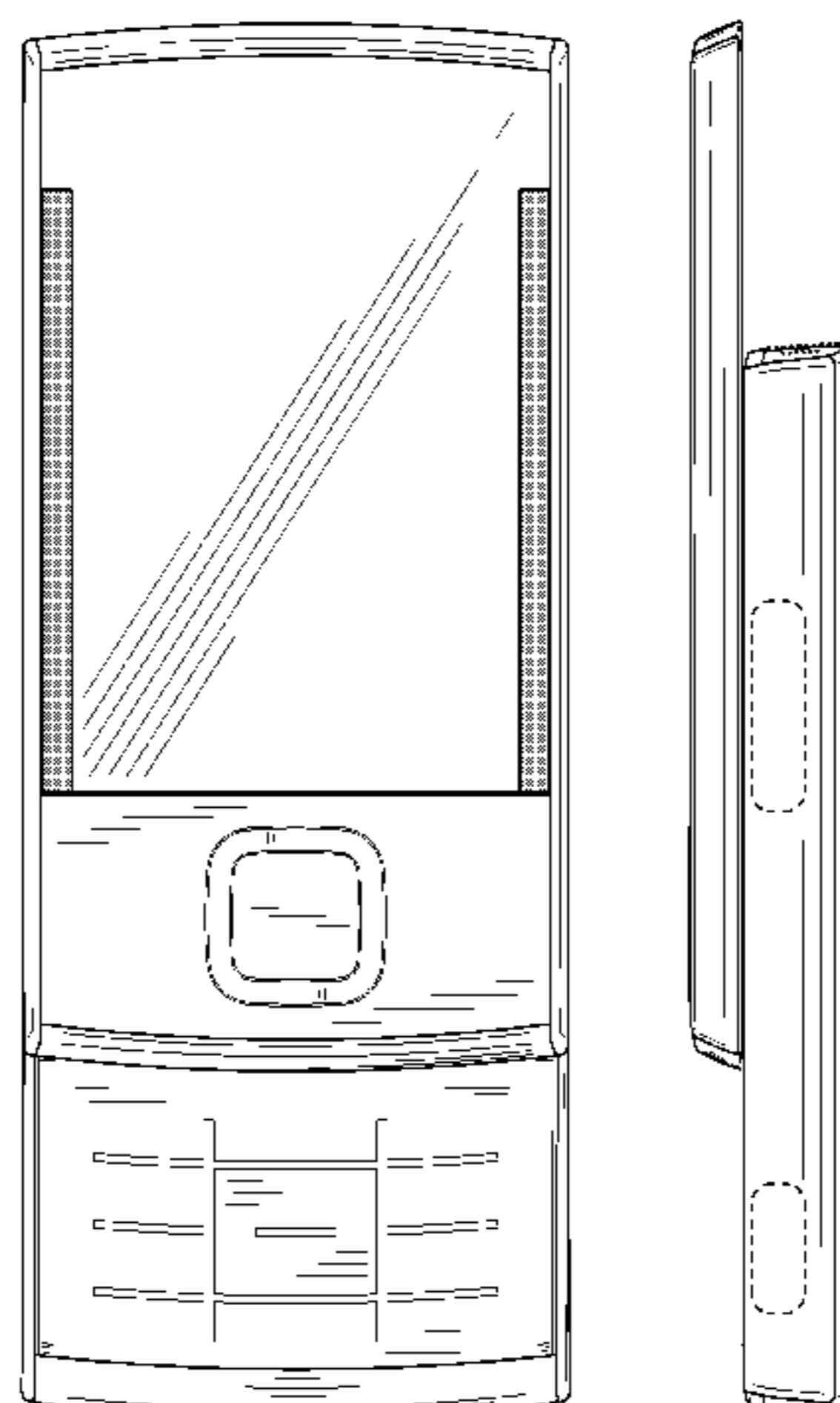

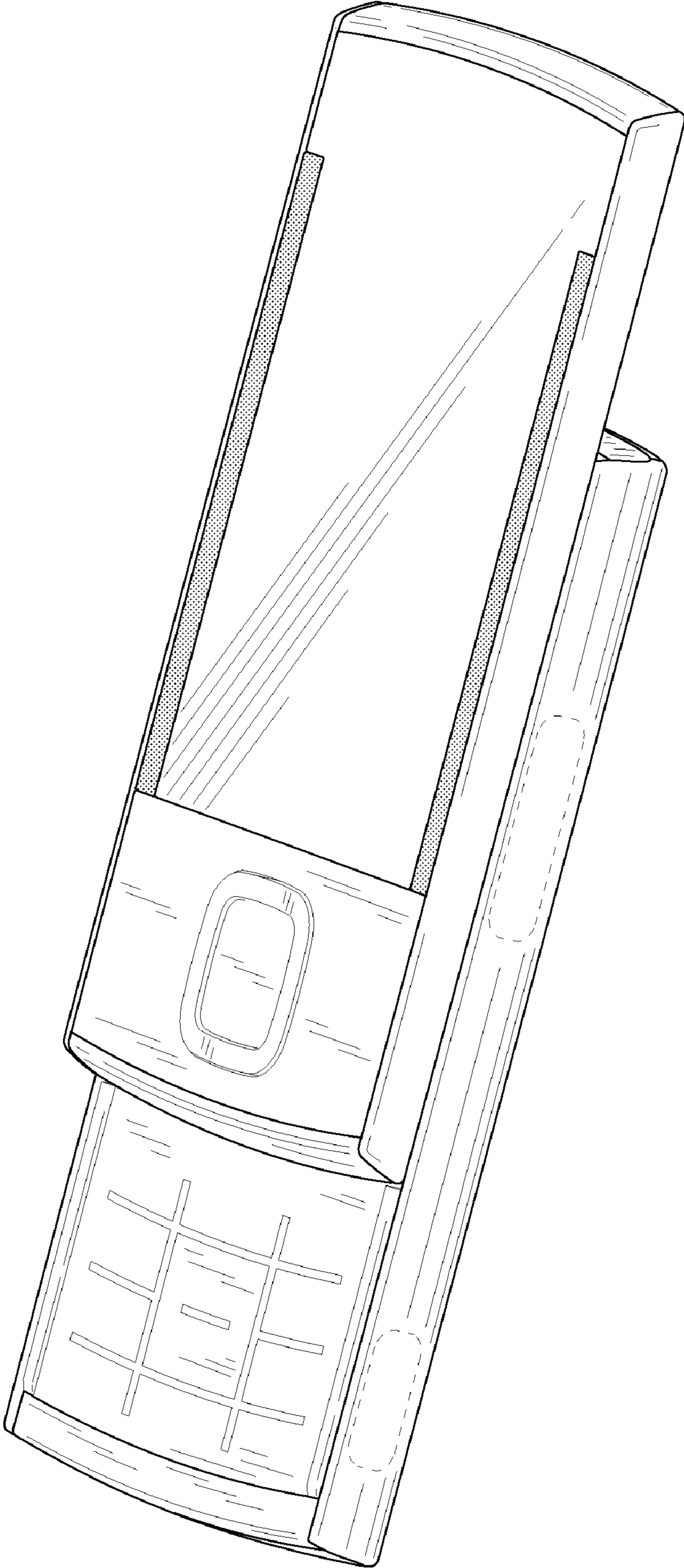

FIG. 1

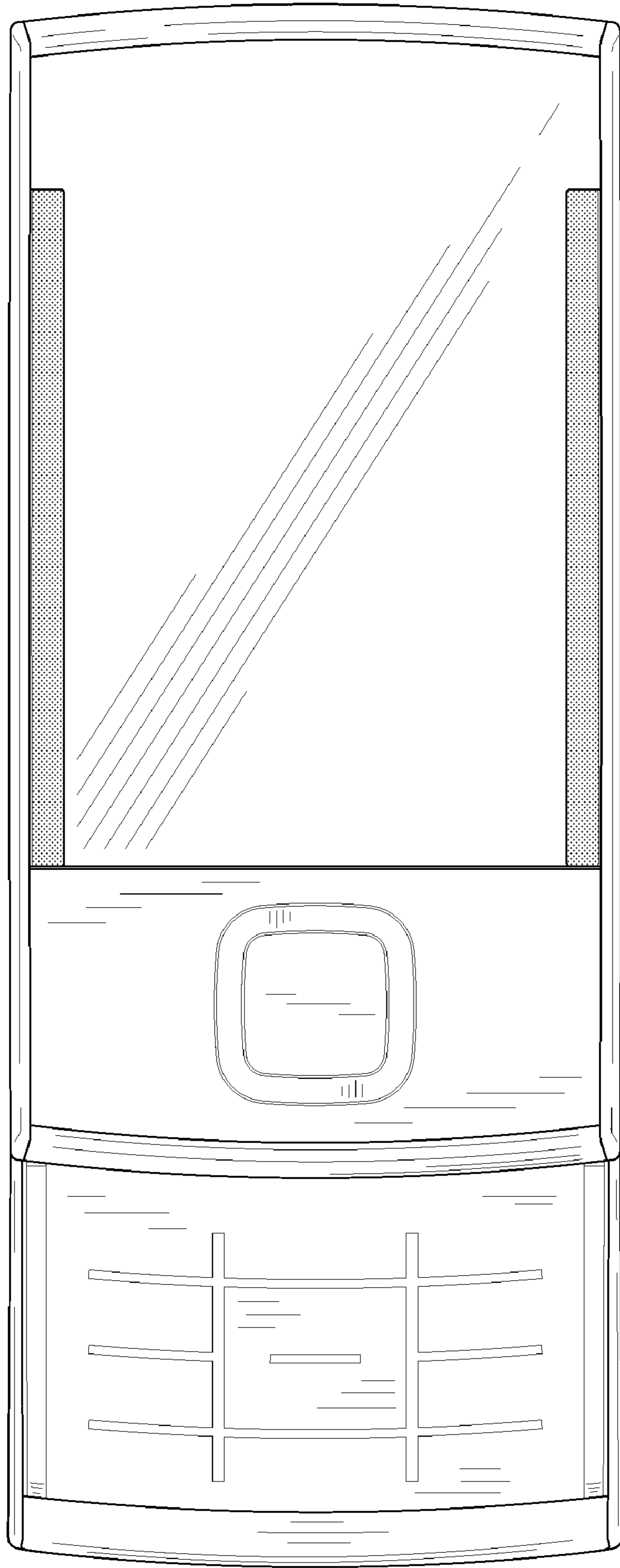

FIG. 2

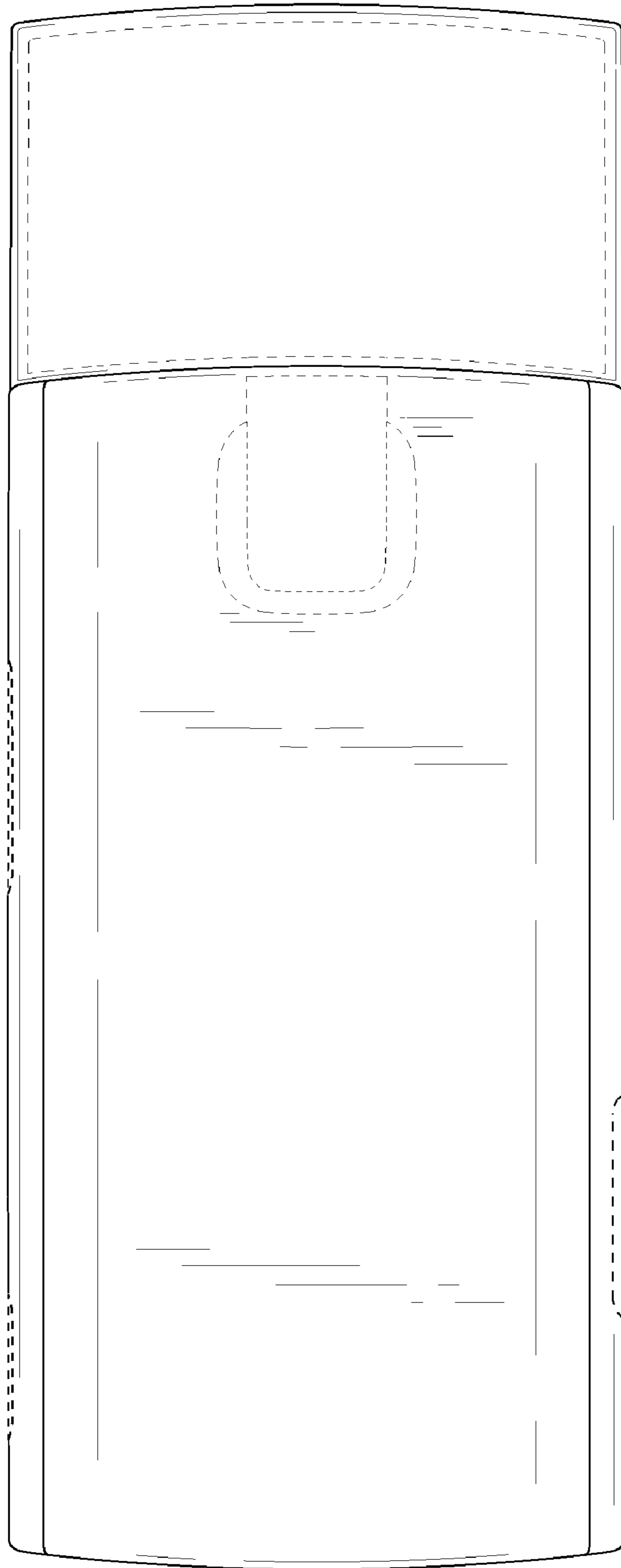

FIG. 3

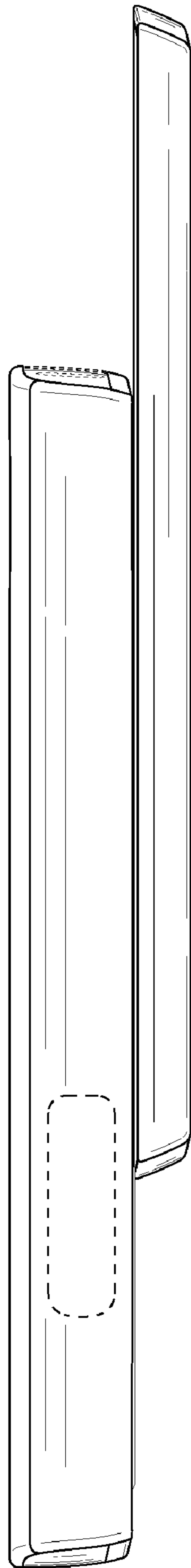

FIG. 4

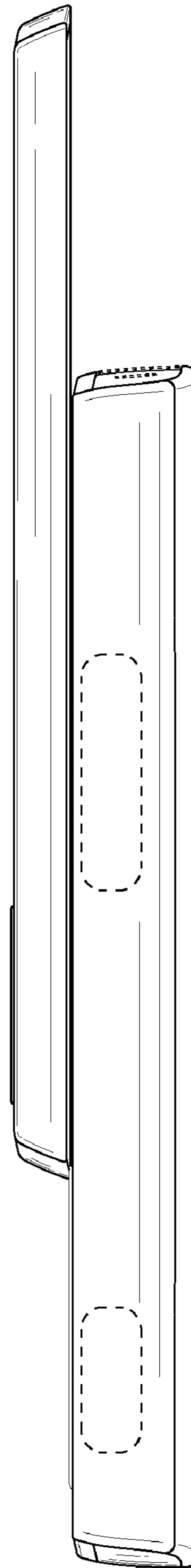

FIG. 5



FIG. 6

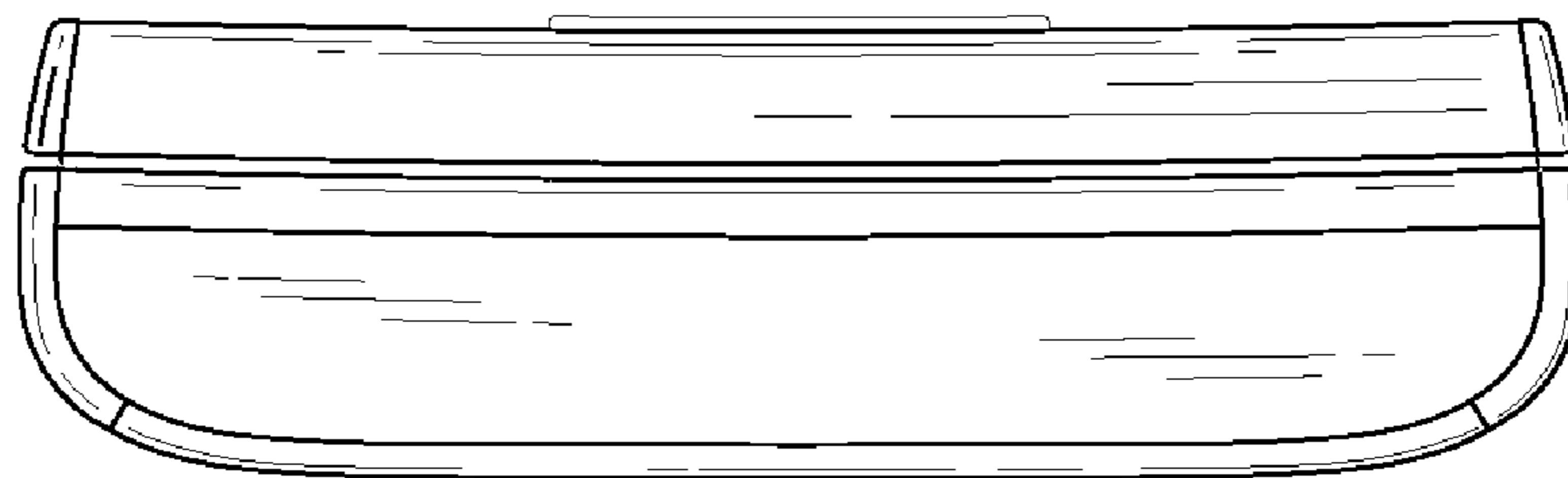

FIG. 7