



US00D617650S

(12) **United States Design Patent**
Swanson

(10) **Patent No.:** **US D617,650 S**
(45) **Date of Patent:** **** Jun. 15, 2010**

(54) **CONTAINER**

(75) Inventor: **Ian Swanson**, Singapore (SG)

(73) Assignee: **The Procter & Gamble Company**,
Cincinnati, OH (US)

(**) Term: **14 Years**

(21) Appl. No.: **29/314,796**

(22) Filed: **Apr. 30, 2009**

(51) **LOC (9) Cl.** **09-01**

(52) **U.S. Cl.** **D9/667; D9/500**

(58) **Field of Classification Search** **D9/500,**
D9/502-504, 516, 521, 667, 695, 697; 215/379,
215/381-382; 220/660, 669-673, 675
See application file for complete search history.

(56) **References Cited**

U.S. PATENT DOCUMENTS

3,078,017	A *	2/1963	Waskonig et al.	222/181.3
3,093,255	A *	6/1963	Ammondson et al.	215/400
3,260,412	A *	7/1966	Larkin	222/107
D237,942	S *	12/1975	Welker, III	D24/117
D248,732	S *	8/1978	Vollmar	D9/697
D281,055	S *	10/1985	Dombroski	D9/697
D374,615	S *	10/1996	Kani	D9/697
D378,492	S *	3/1997	Salle	D9/690
D412,107	S *	7/1999	Bosshardt	D9/697
D454,780	S *	3/2002	Leboeuf et al.	D9/697
D482,794	S *	11/2003	Whitley	D24/224
D491,066	S *	6/2004	Le Goff	D9/500
D569,727	S *	5/2008	Moretti	D9/529
D576,047	S *	9/2008	Reihle	D9/500
D577,289	S *	9/2008	Moretti	D9/500

* cited by examiner

Primary Examiner—Ian Simmons

Assistant Examiner—Dana L Sipos

(74) *Attorney, Agent, or Firm*—Linda M. Sivik

(57) **CLAIM**

The ornamental design for container, as shown and described.

DESCRIPTION

FIG. 1 is a top, front perspective view of a container showing our new design;

FIG. 2 is a front elevation view thereof;

FIG. 3 is a rear elevation view thereof;

FIG. 4 is a left side elevation view thereof;

FIG. 5 is a right side elevation view thereof;

FIG. 6 is a top plan view thereof;

FIG. 7 is a bottom plan view thereof;

FIG. 8 is a top, front perspective view of a second embodiment of a container showing our new design;

FIG. 9 is a front elevation view thereof;

FIG. 10 is a rear elevation view thereof;

FIG. 11 is a left side elevation view thereof;

FIG. 12 is a right side elevation view thereof;

FIG. 13 is a top plan view thereof;

FIG. 14 is a bottom plan view thereof;

FIG. 15 is a top, front perspective view of a third embodiment of a container showing our new design;

FIG. 16 is a front elevation view thereof;

FIG. 17 is a rear elevation view thereof;

FIG. 18 is a left side elevation view thereof;

FIG. 19 is a right side elevation view thereof;

FIG. 20 is a top plan view thereof;

FIG. 21 is a bottom plan view thereof;

FIG. 22 is a top, front perspective view of a fourth embodiment of a container showing our new design;

FIG. 23 is a front elevation view thereof;

FIG. 24 is a rear elevation view thereof;

FIG. 25 is a left side elevation view thereof;

FIG. 26 is a right side elevation view thereof;

FIG. 27 is a top plan view thereof;

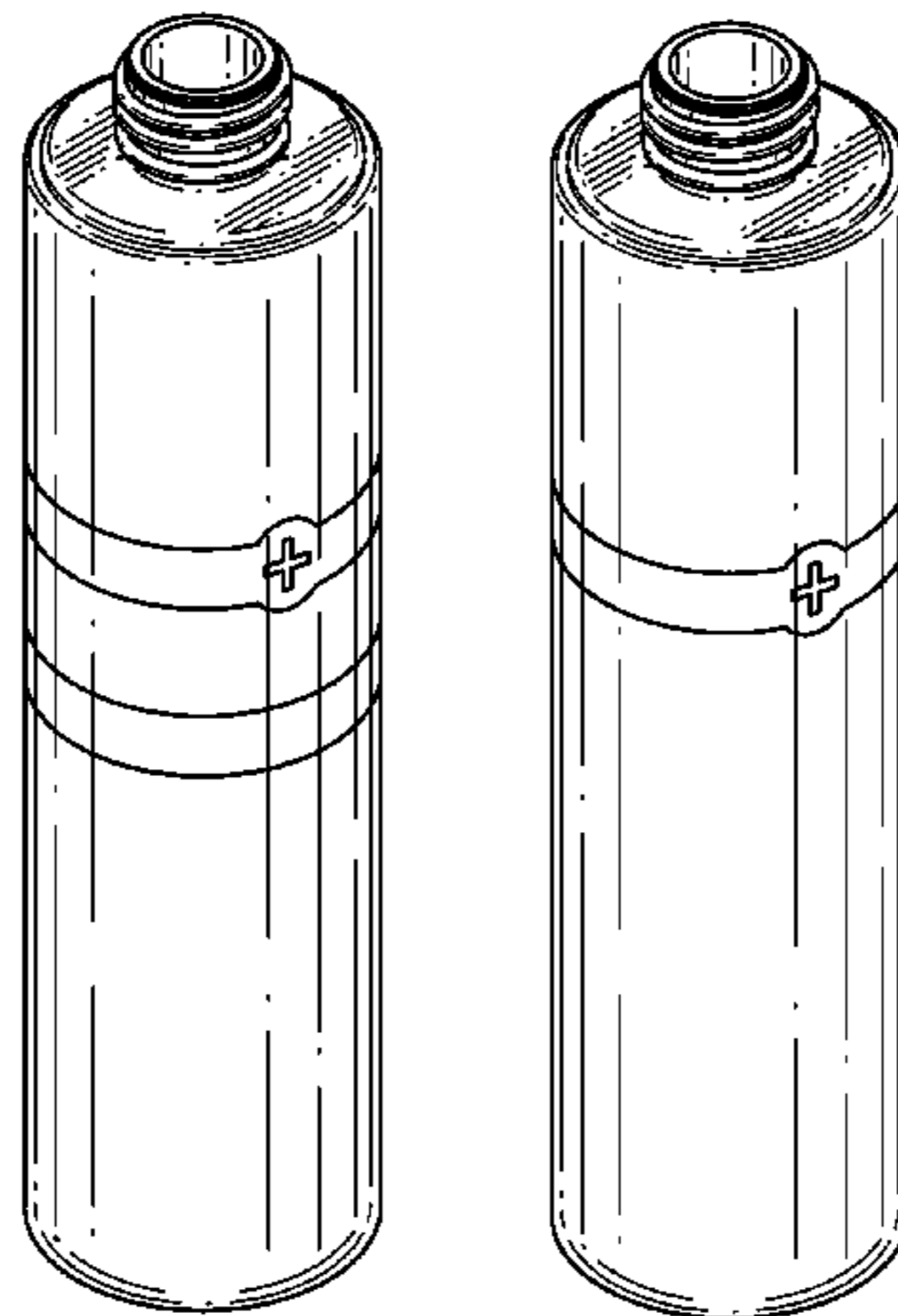

FIG. 28 is a bottom plan view thereof;
FIG. 29 is a top, front perspective view of a fifth embodiment of a container showing our new design;
FIG. 30 is a front elevation view thereof;
FIG. 31 is a rear elevation view thereof;
FIG. 32 is a left side elevation view thereof;
FIG. 33 is a right side elevation view thereof;
FIG. 34 is a top plan view thereof;
FIG. 35 is a bottom plan view thereof;
FIG. 36 is a top, front perspective view of a sixth embodiment of a container showing our new design;
FIG. 37 is a front elevation view thereof;
FIG. 38 is a rear elevation view thereof;
FIG. 39 is a left side elevation view thereof;
FIG. 40 is a right side elevation view thereof;
FIG. 41 is a top plan view thereof;
FIG. 42 is a bottom plan view thereof;
FIG. 43 is a top, front perspective view of a seventh embodiment of a container showing our new design;
FIG. 44 is a front elevation view thereof;
FIG. 45 is a rear elevation view thereof;

FIG. 46 is a left side elevation view thereof;
FIG. 47 is a right side elevation view thereof;
FIG. 48 is a top plan view thereof;
FIG. 49 is a bottom plan view thereof;
FIG. 50 is a top, front perspective view of an eighth embodiment of a container showing our new design;
FIG. 51 is a front elevation view thereof;
FIG. 52 is a rear elevation view thereof;
FIG. 53 is a left side elevation view thereof;
FIG. 54 is a right side elevation view thereof;
FIG. 55 is a top plan view thereof;
FIG. 56 is a bottom plan view thereof;
FIG. 57 is a top, front perspective view of a ninth embodiment of a container showing our new design;
FIG. 58 is a front elevation view thereof;
FIG. 59 is a rear elevation view thereof;
FIG. 60 is a left side elevation view thereof;
FIG. 61 is a right side elevation view thereof;
FIG. 62 is a top plan view thereof; and,
FIG. 63 is a bottom plan view thereof.

1 Claim, 36 Drawing Sheets

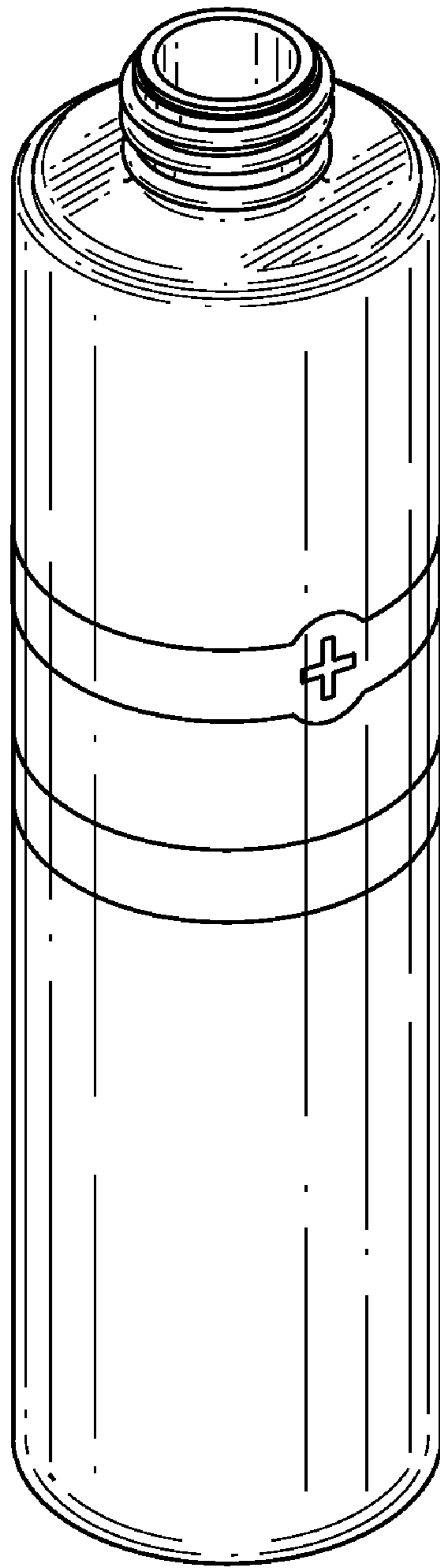

Fig. 1

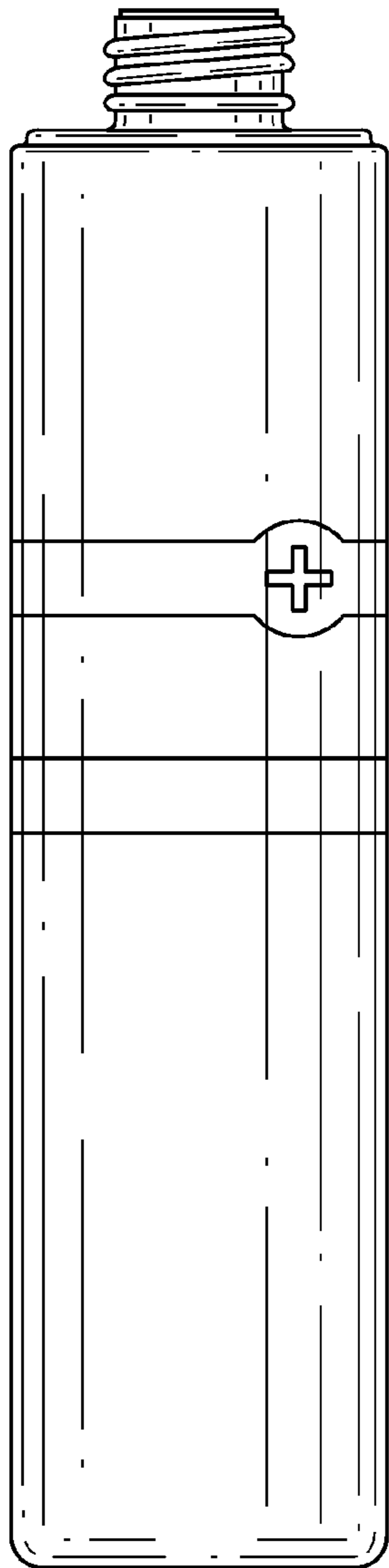

Fig. 2

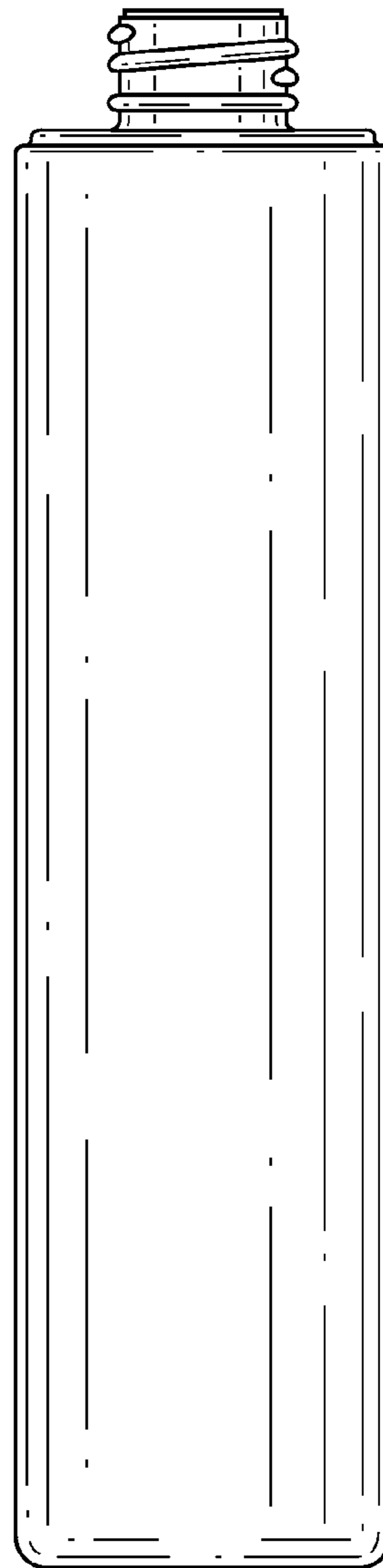

Fig. 3

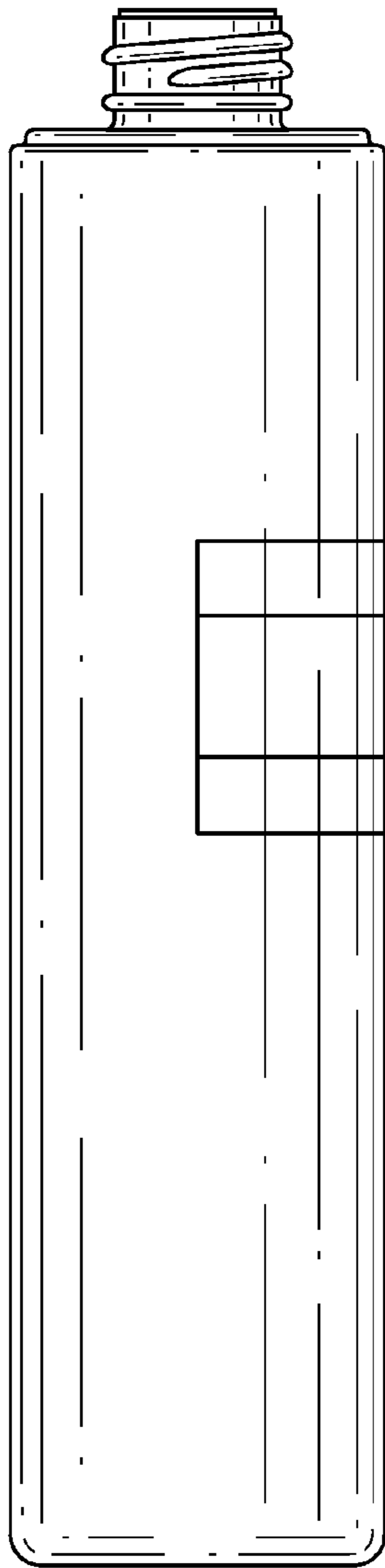

Fig. 4

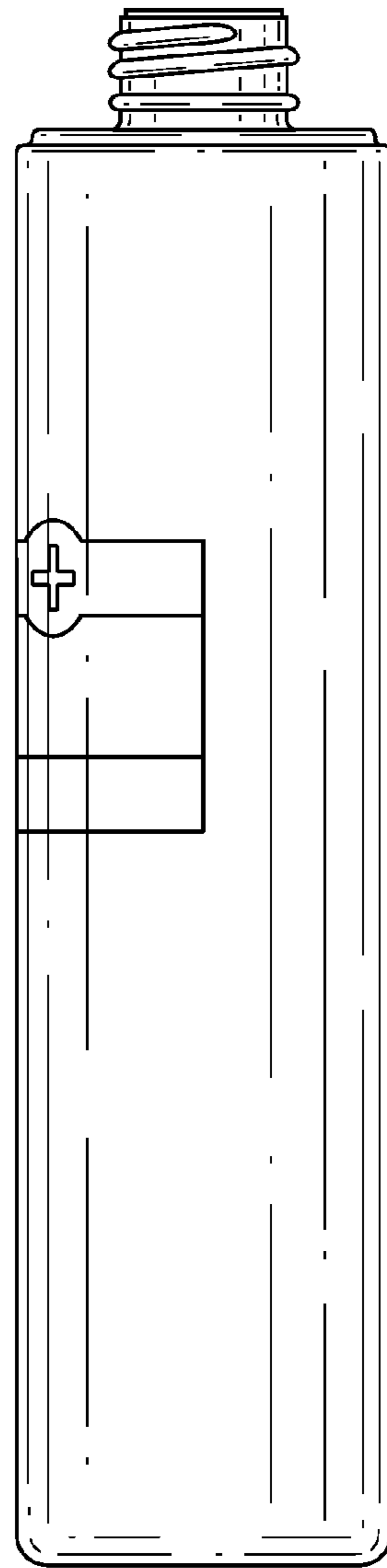

Fig. 5

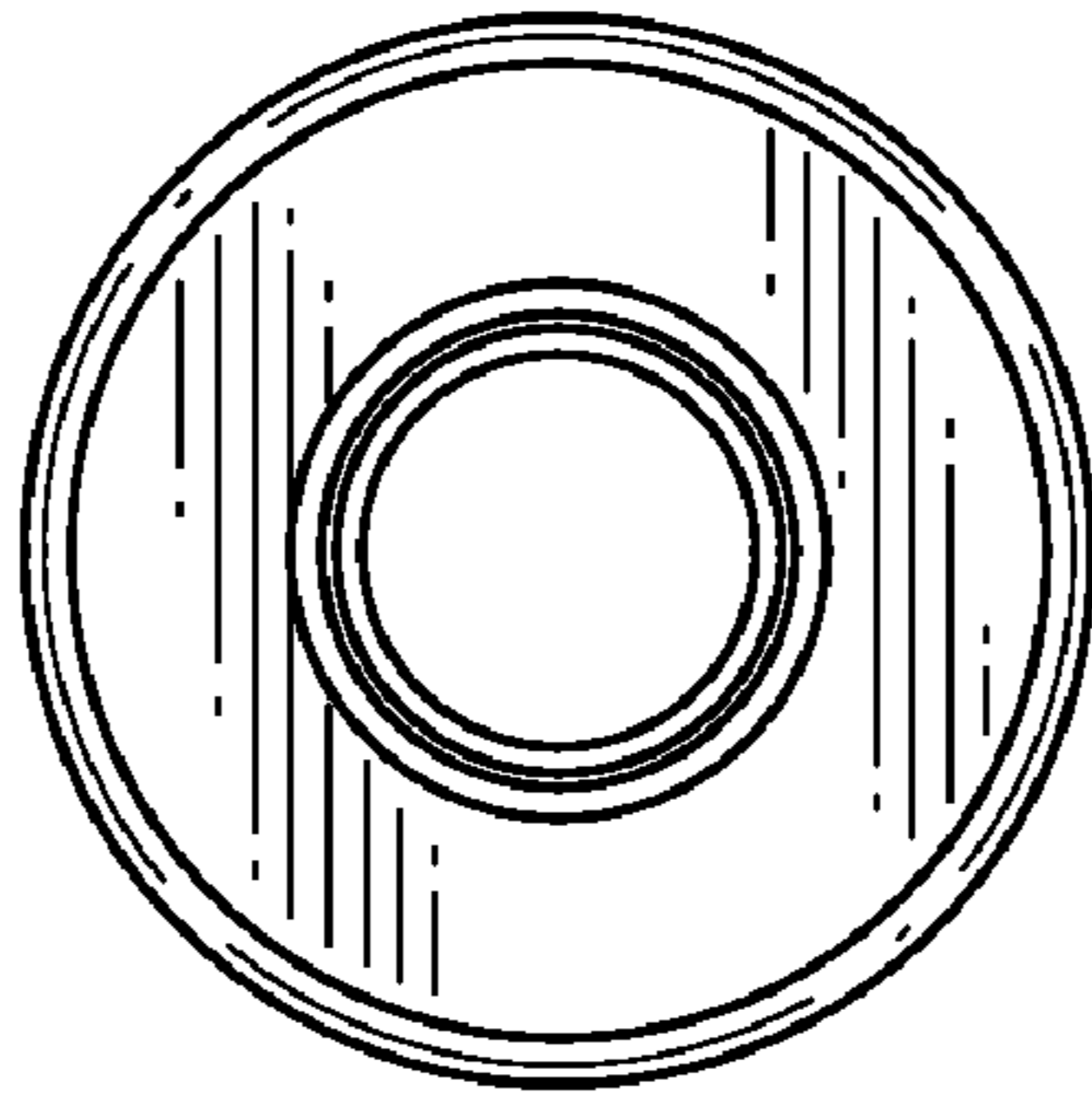

Fig. 6

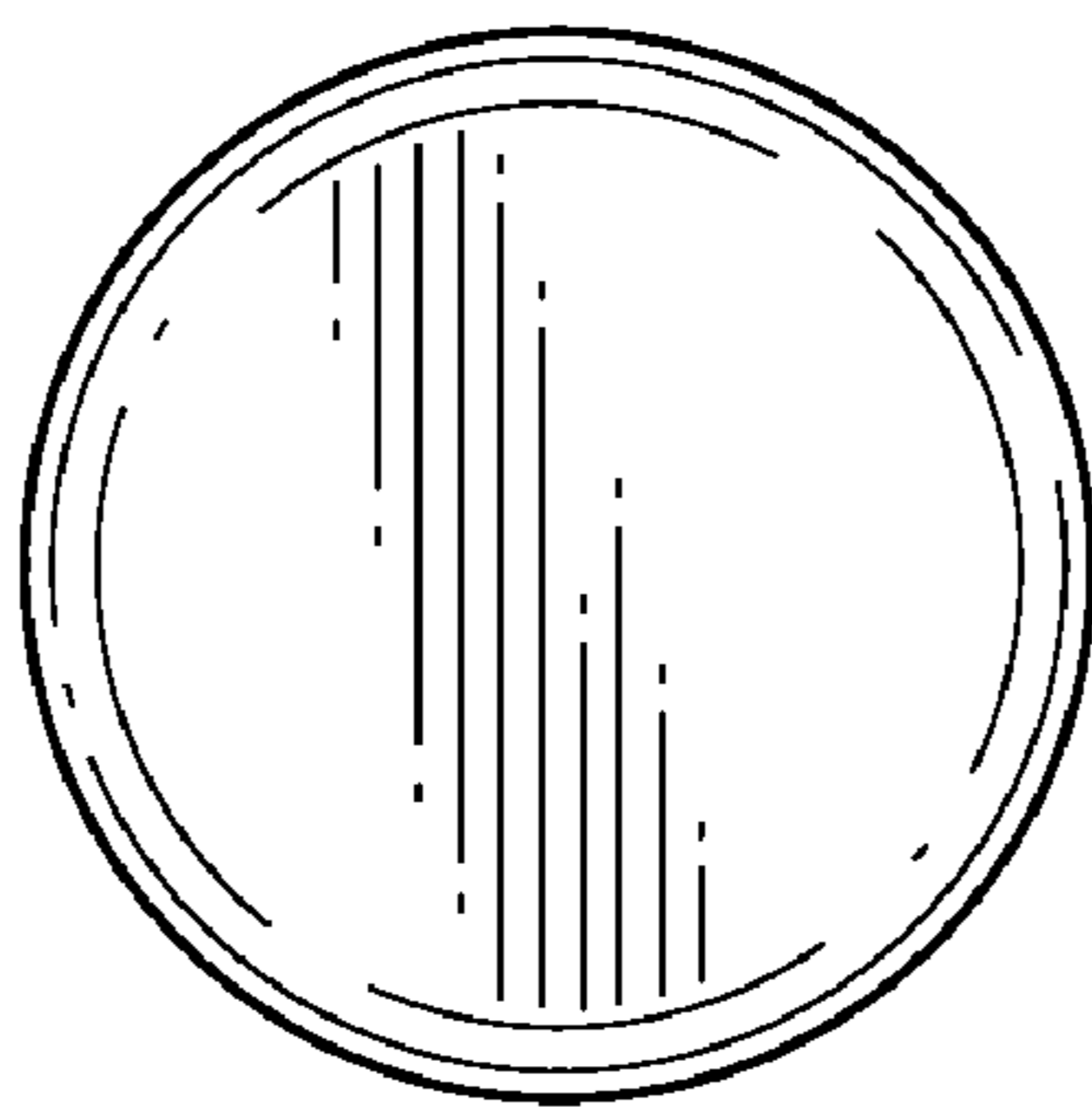

Fig. 7

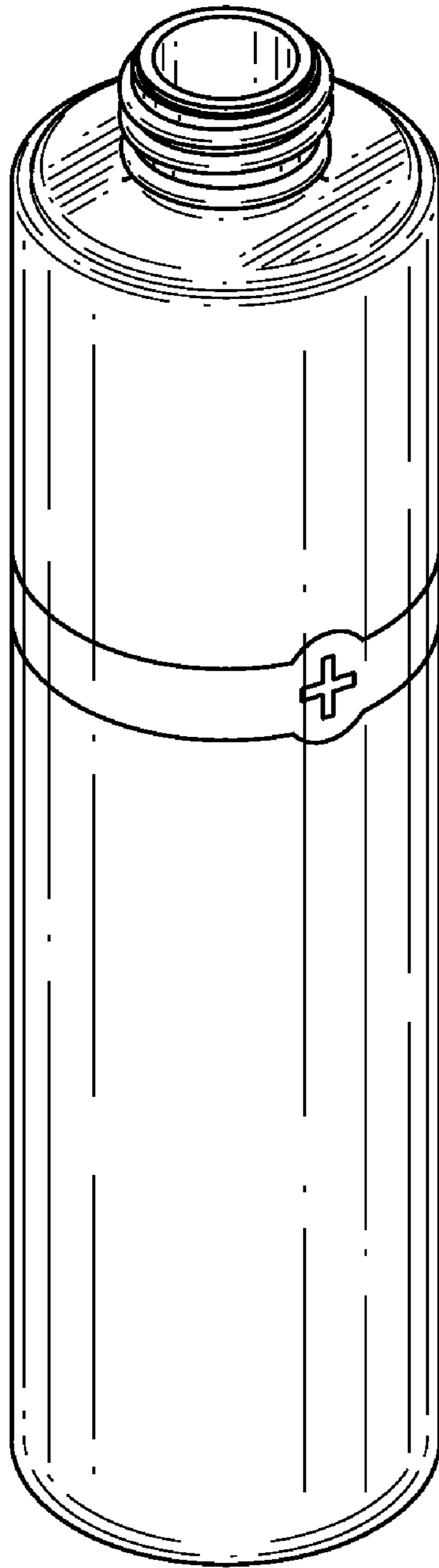

Fig. 8

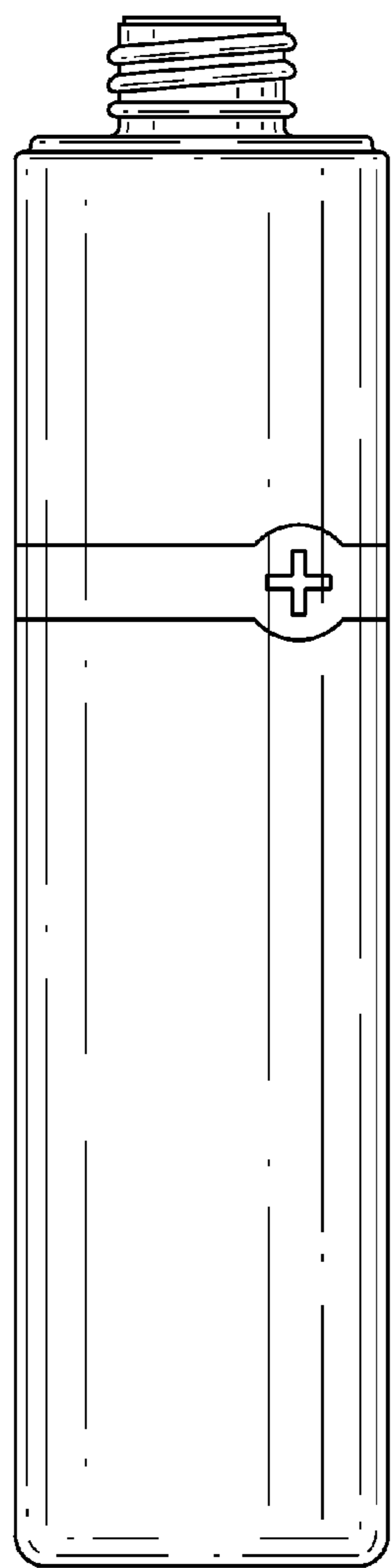

Fig. 9

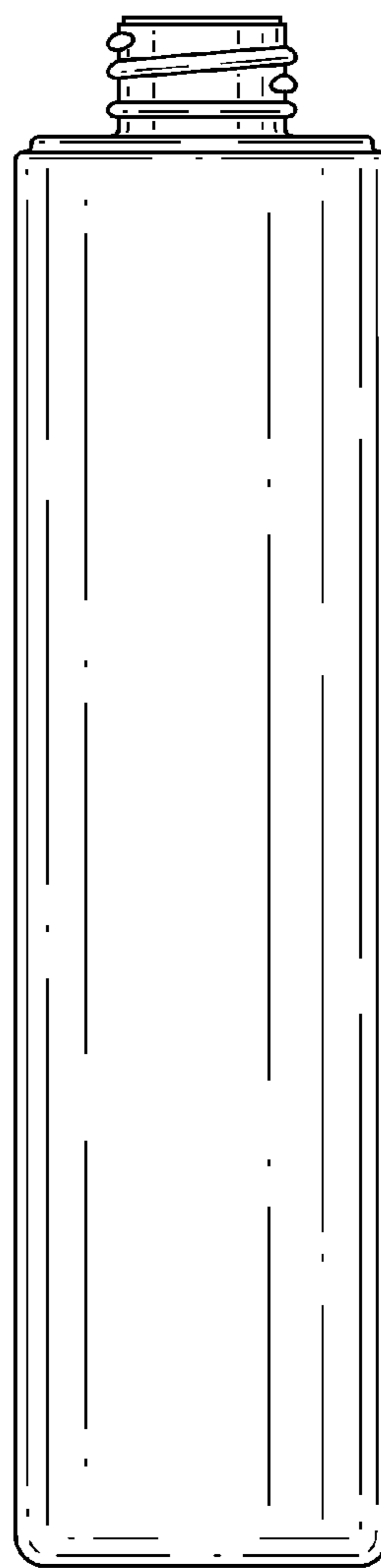

Fig. 10

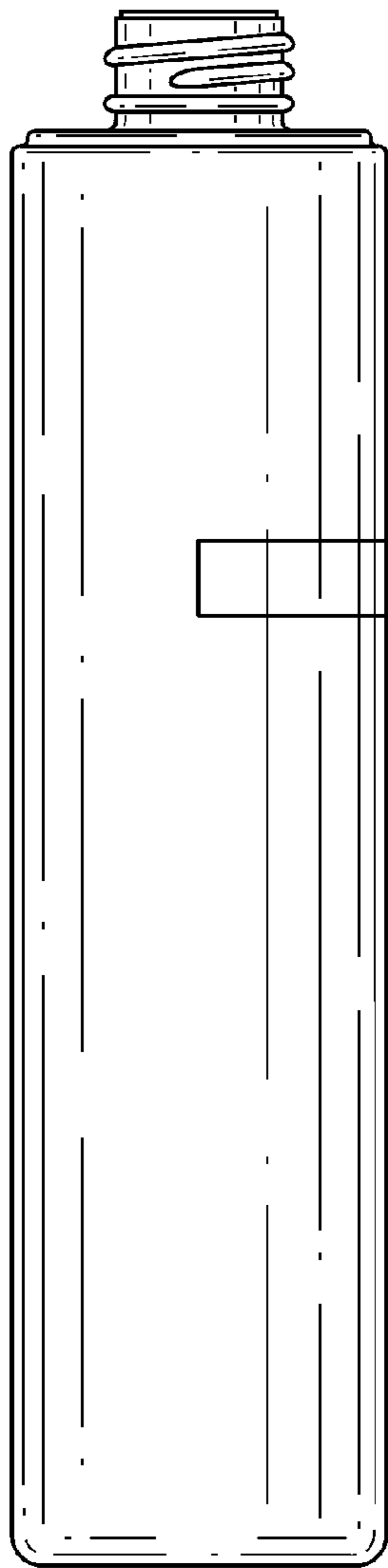

Fig. 11

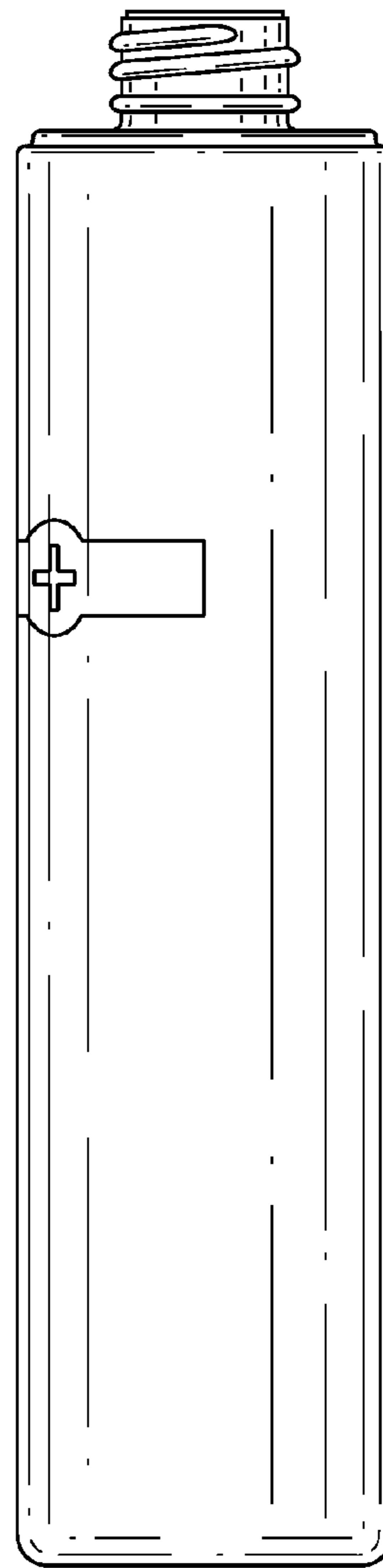

Fig. 12

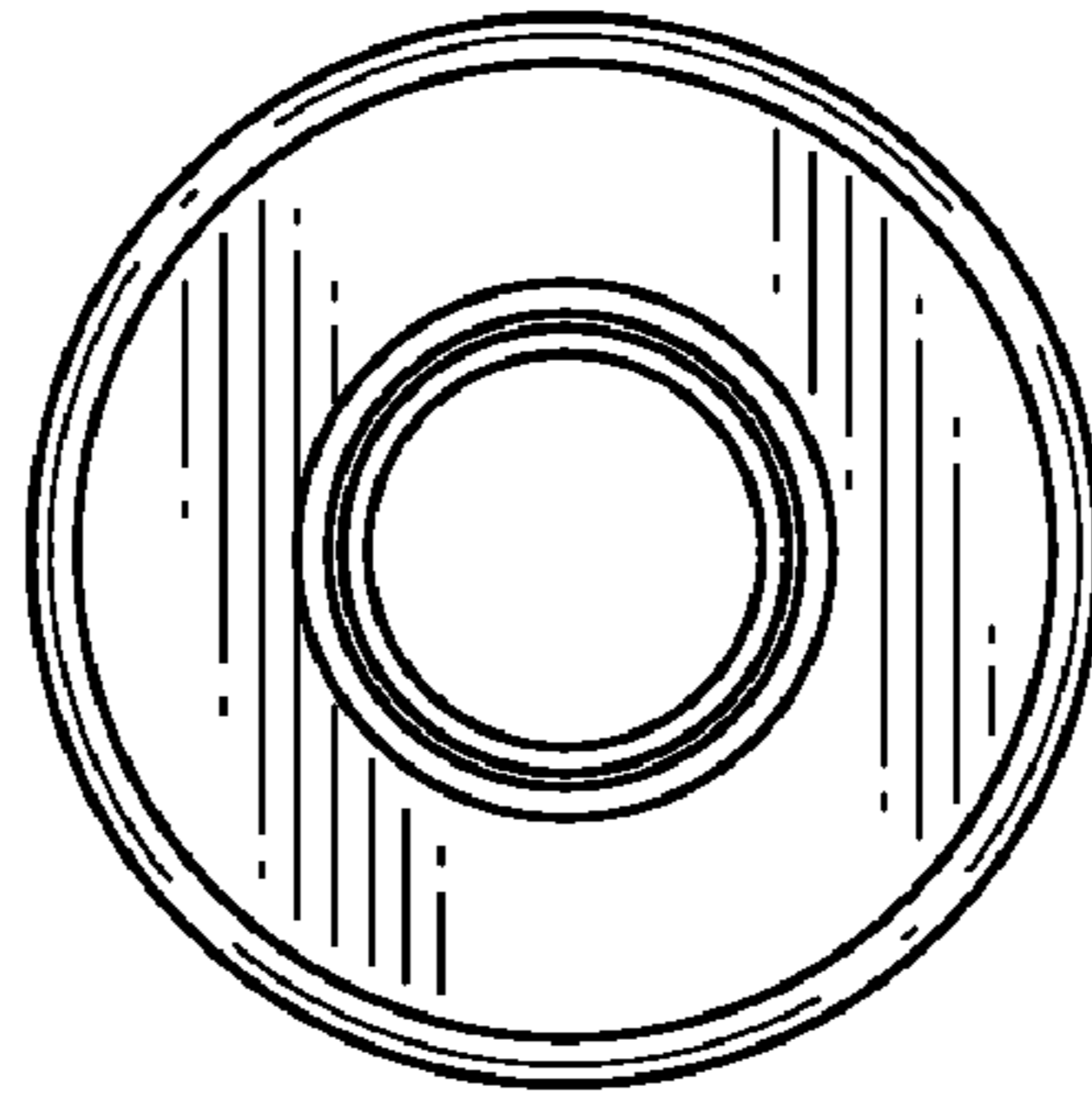

Fig. 13

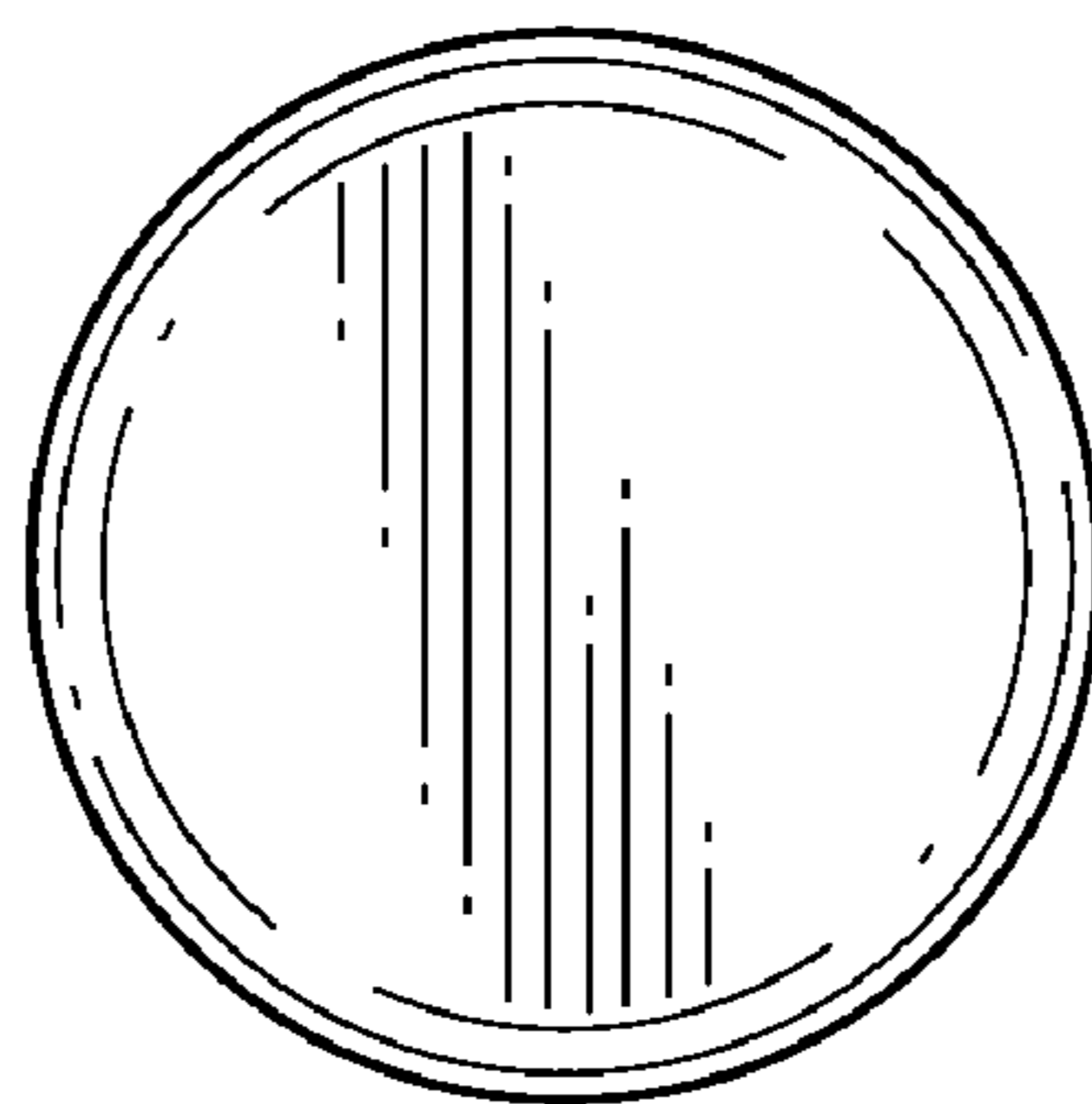

Fig. 14

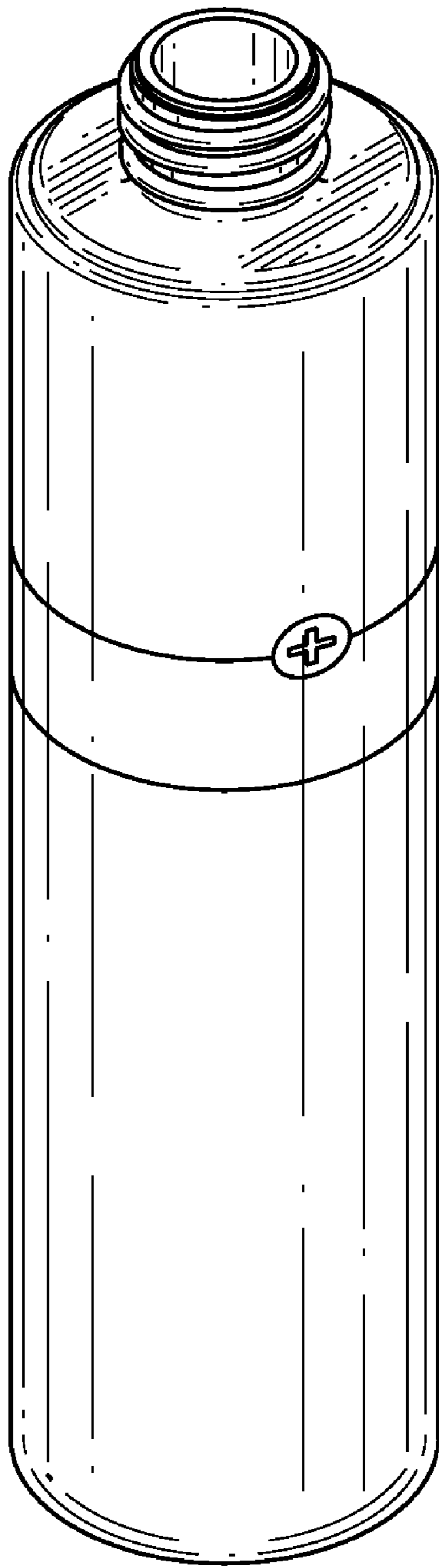

Fig. 15

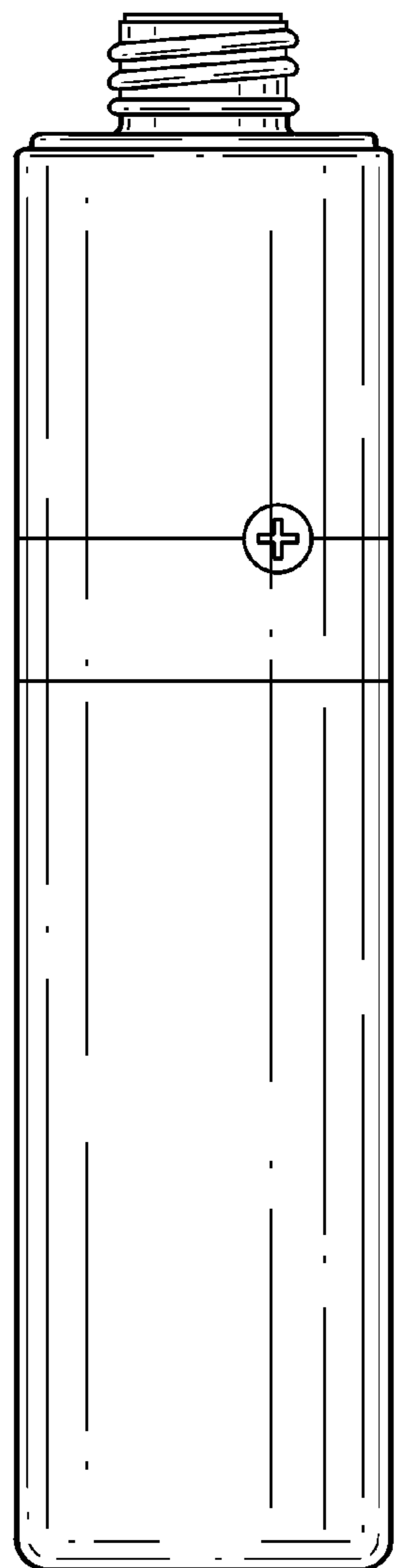

Fig. 16

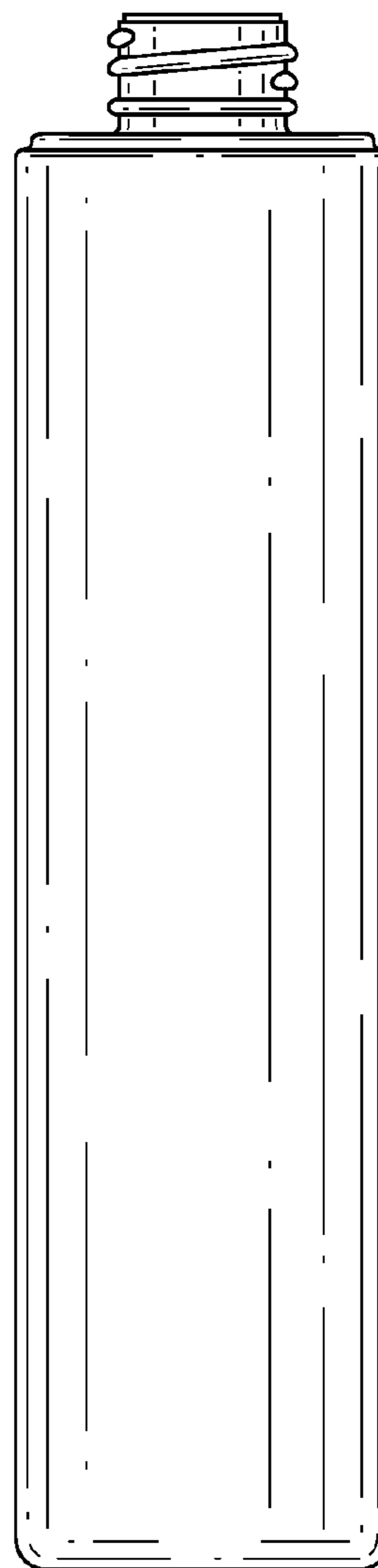

Fig. 17

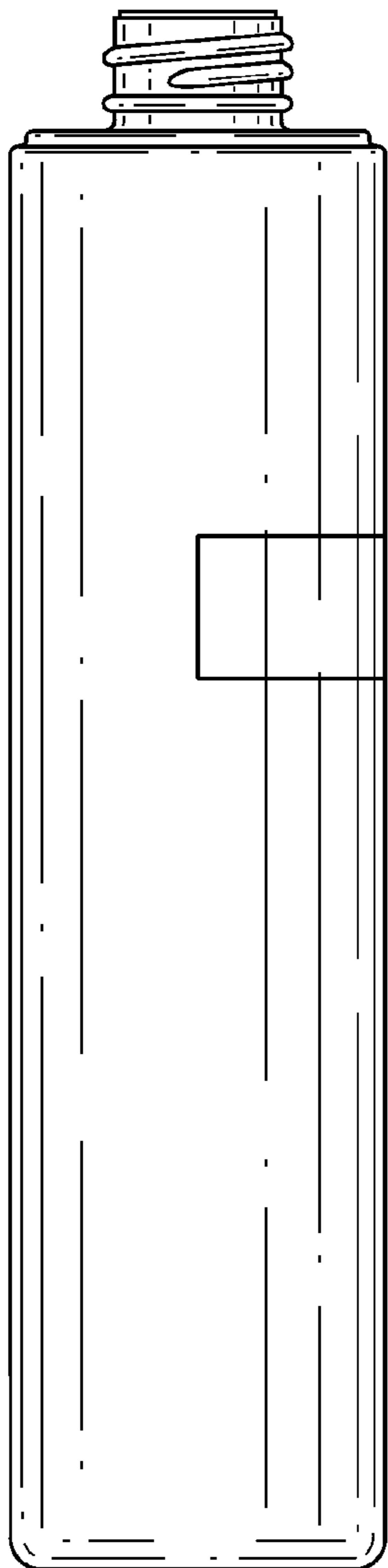

Fig. 18

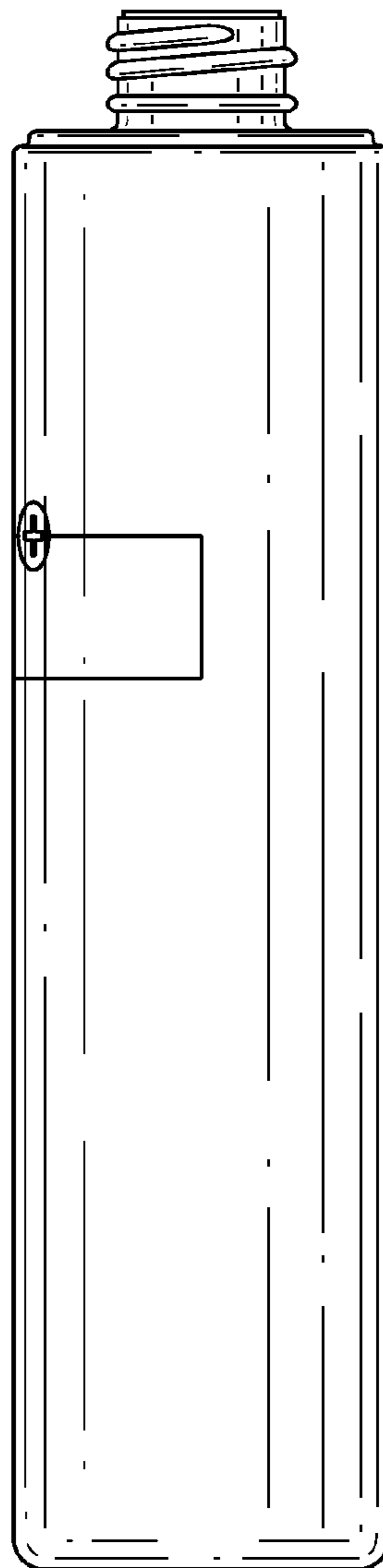

Fig. 19

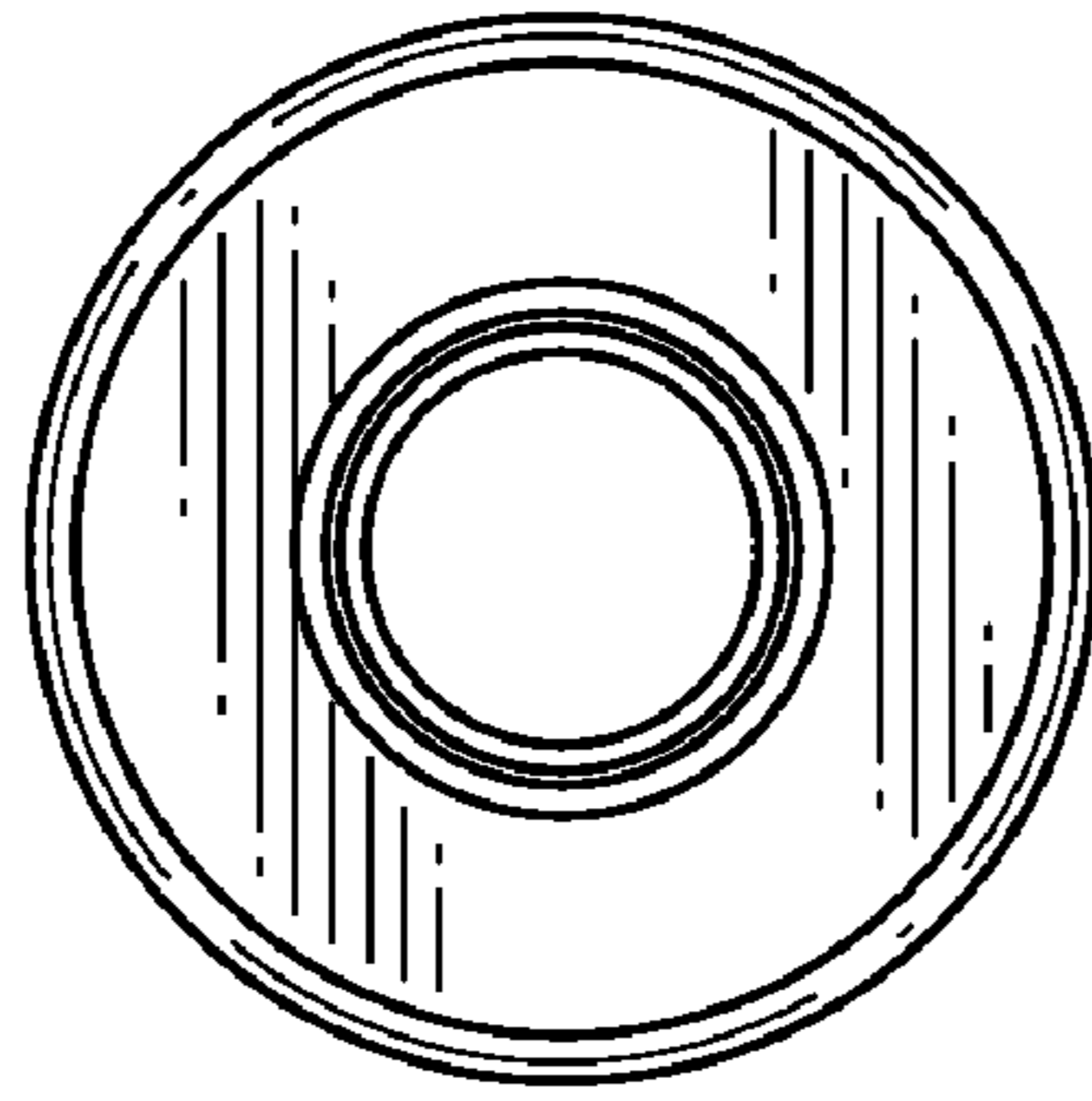

Fig. 20

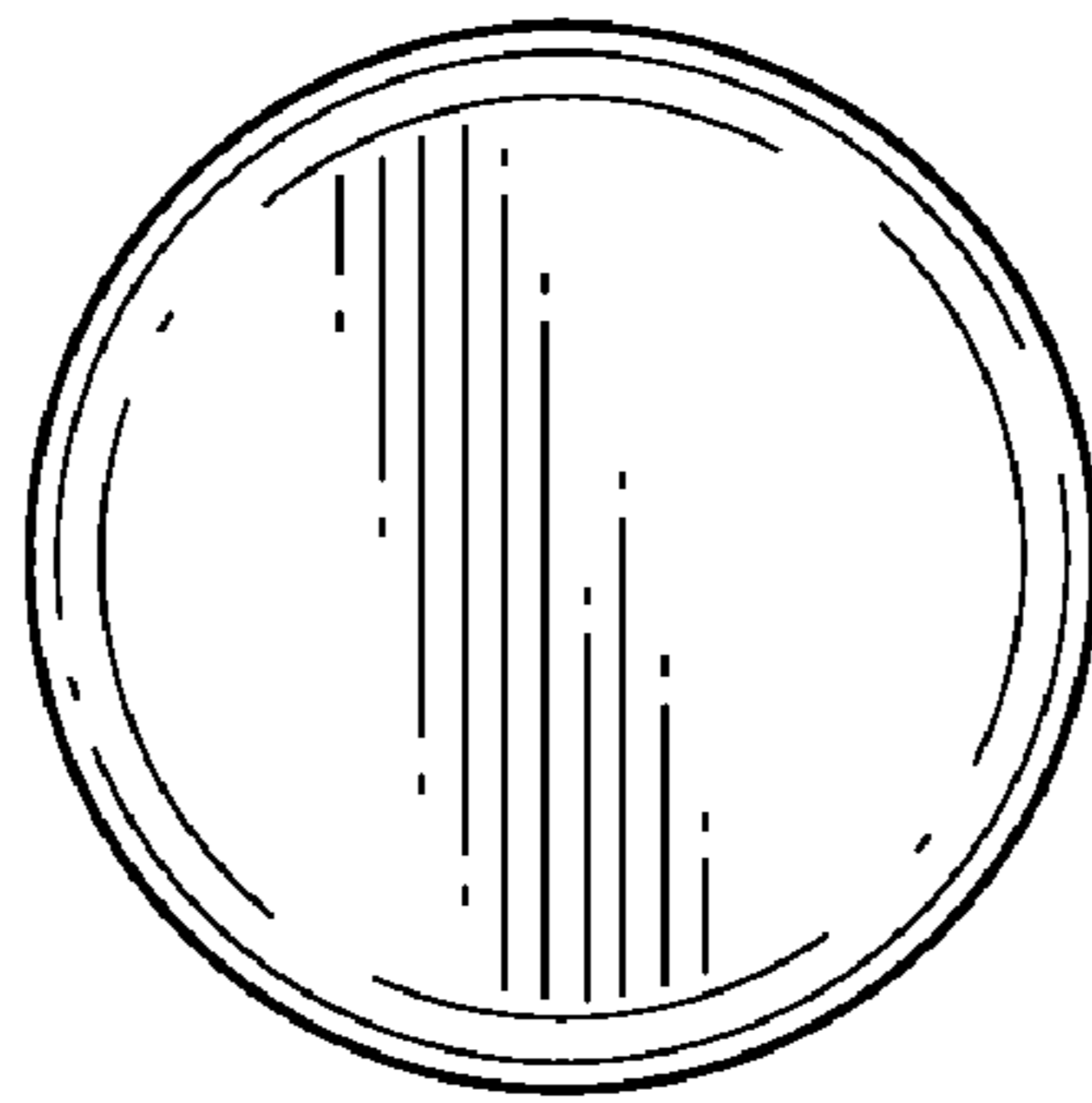

Fig. 21

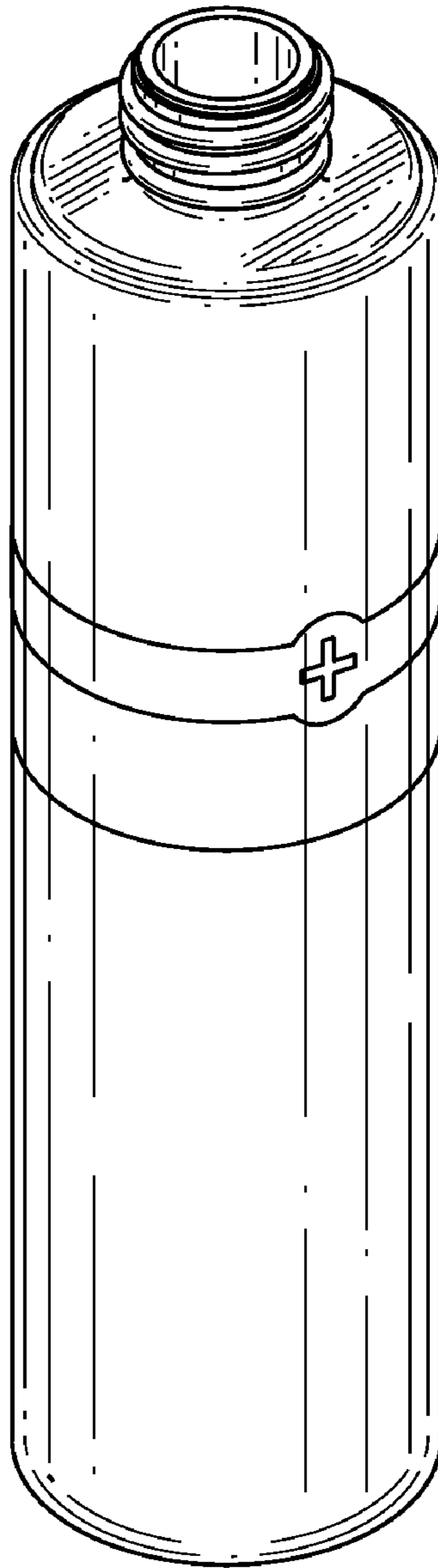

Fig. 22

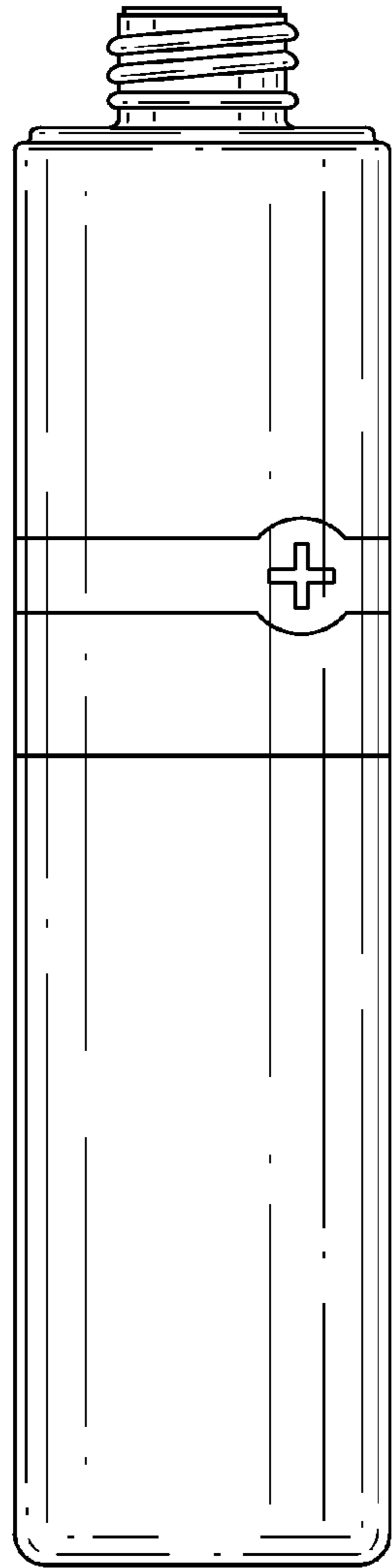

Fig. 23

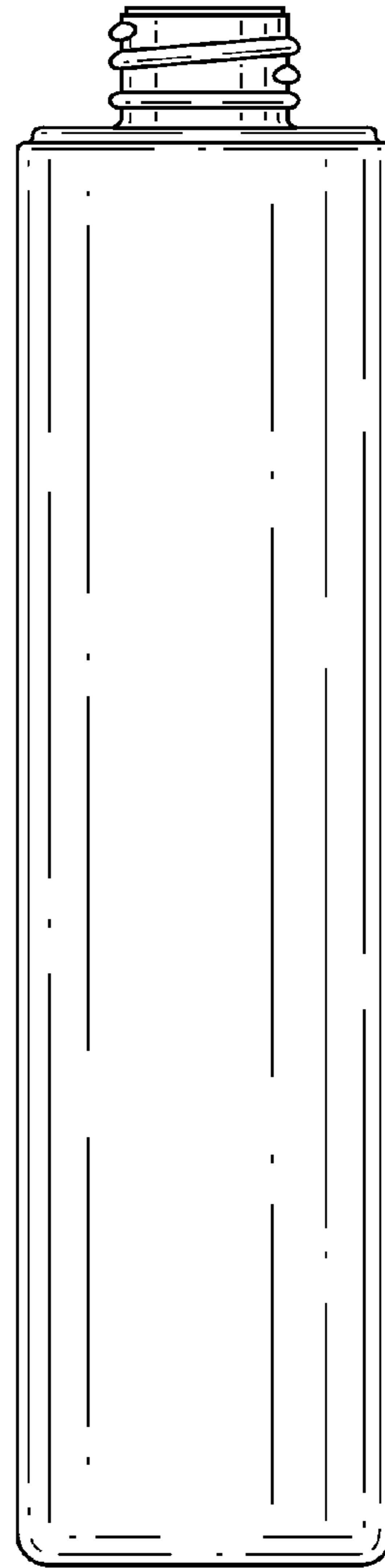

Fig. 24

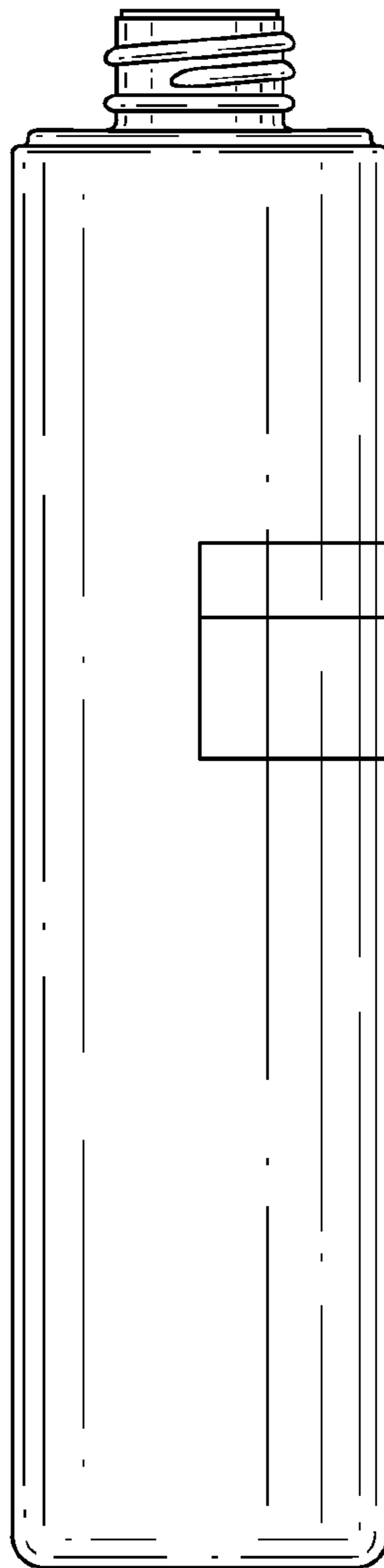

Fig. 25

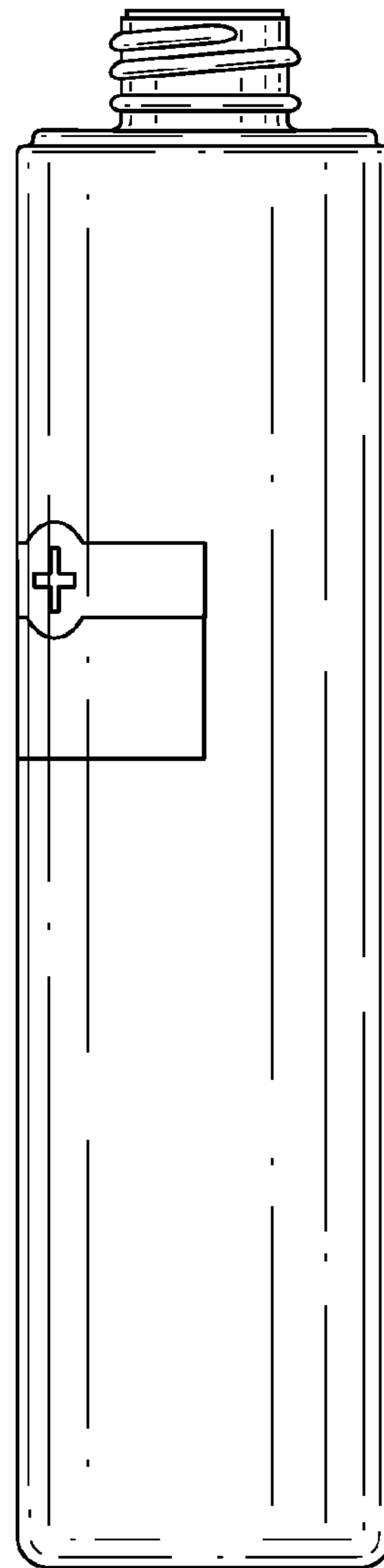

Fig. 26

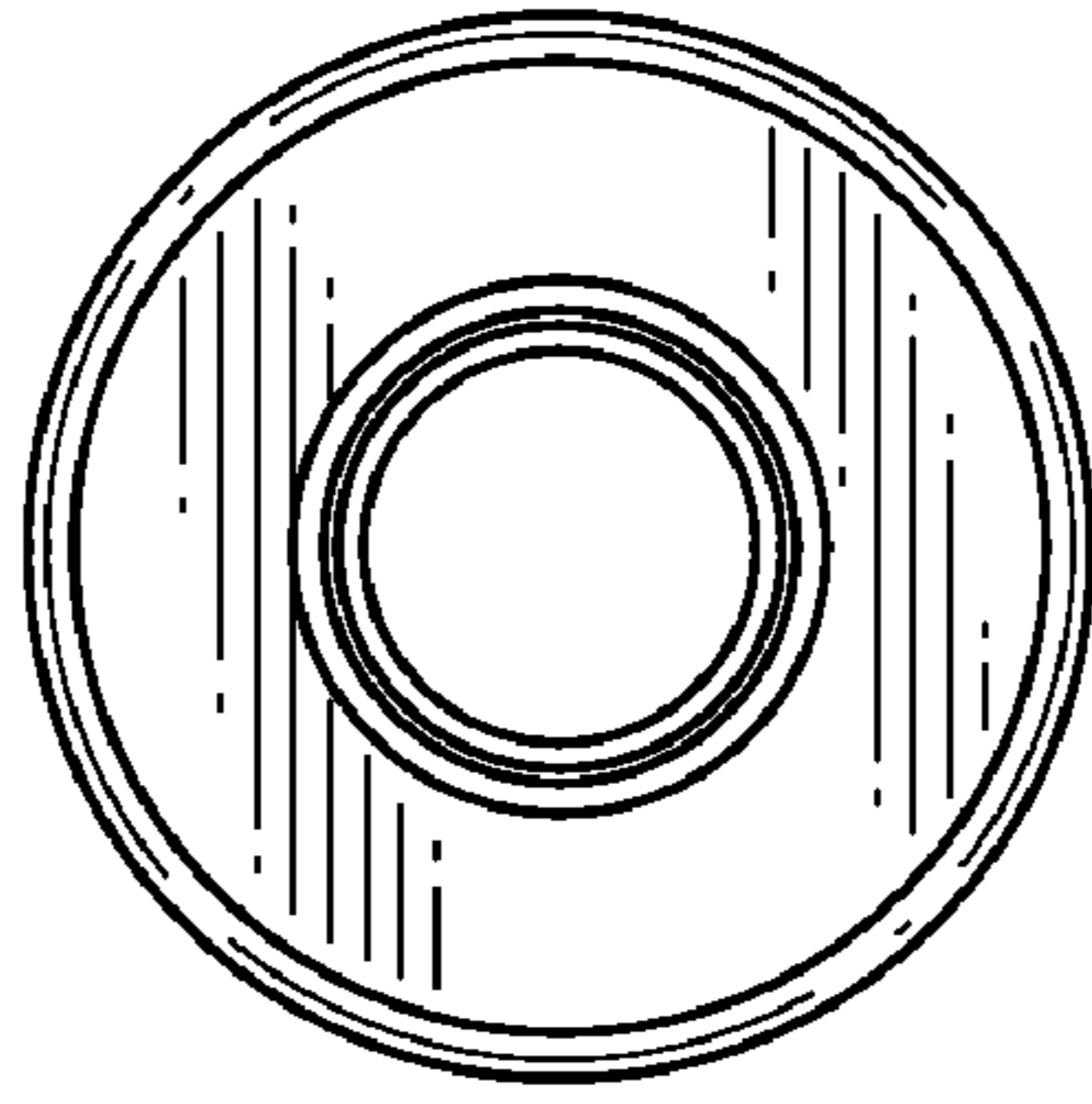

Fig. 27

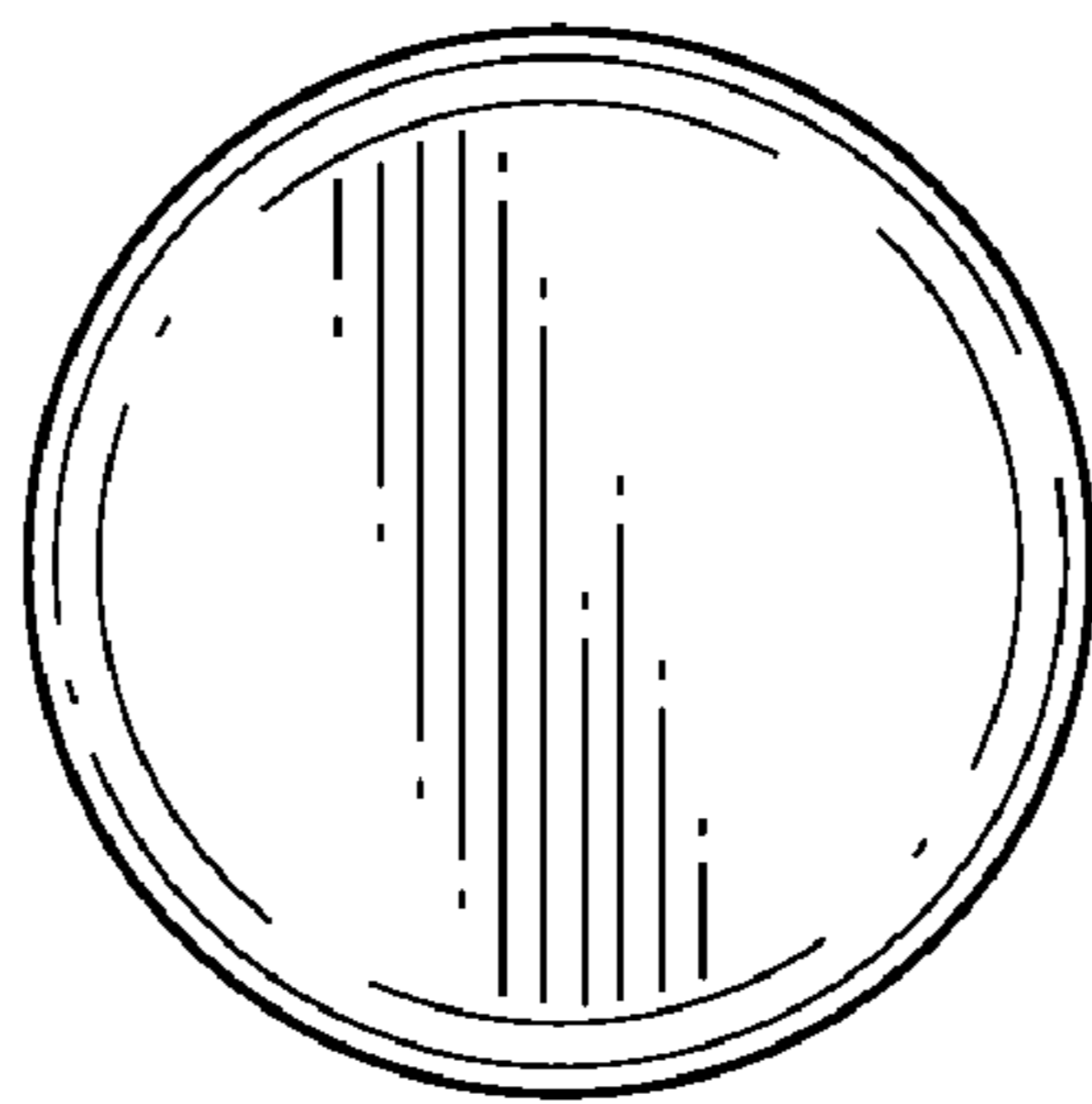

Fig. 28

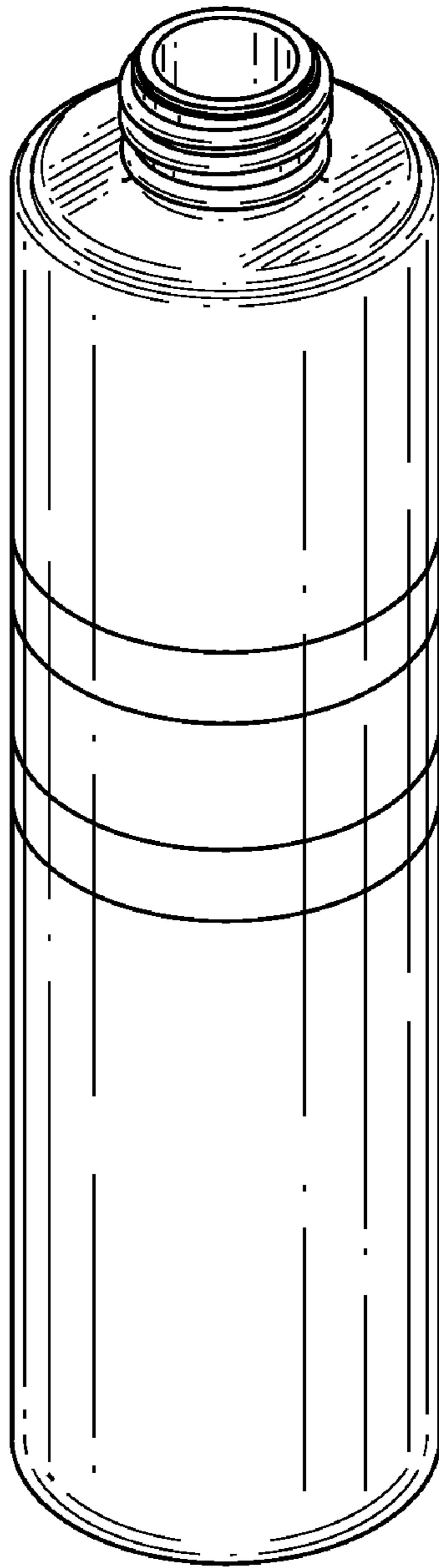

Fig. 29

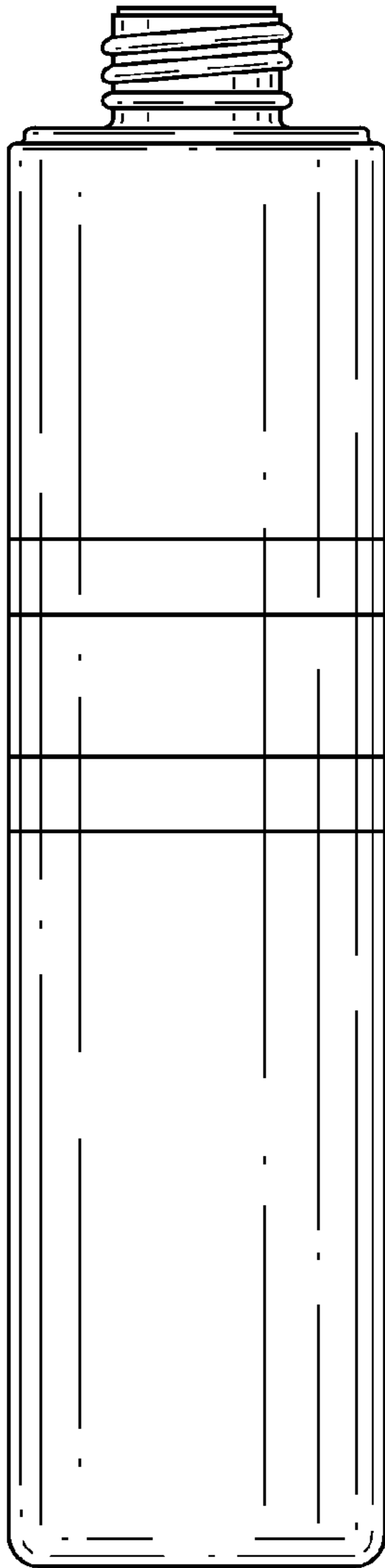

Fig. 30

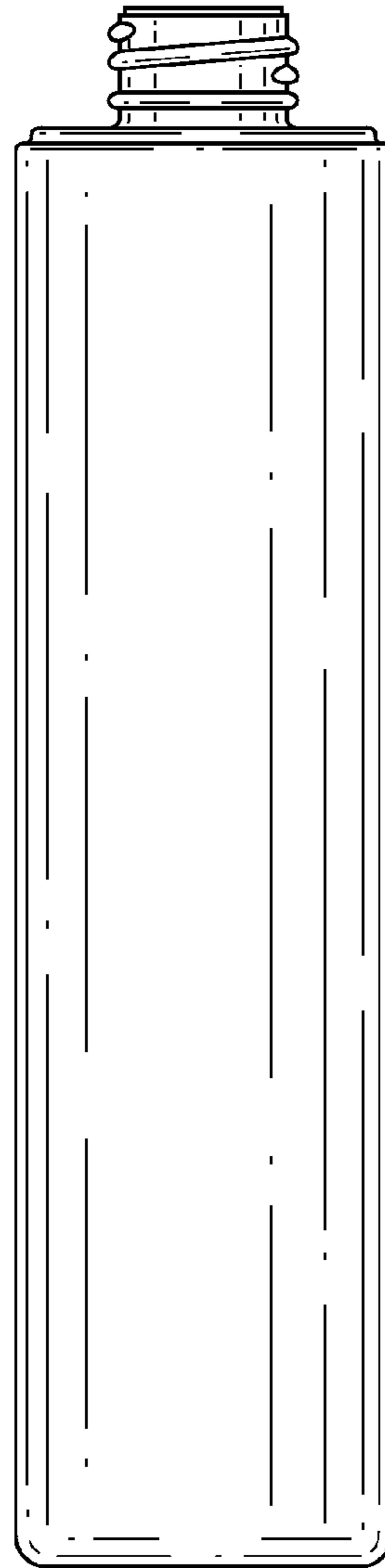

Fig. 31

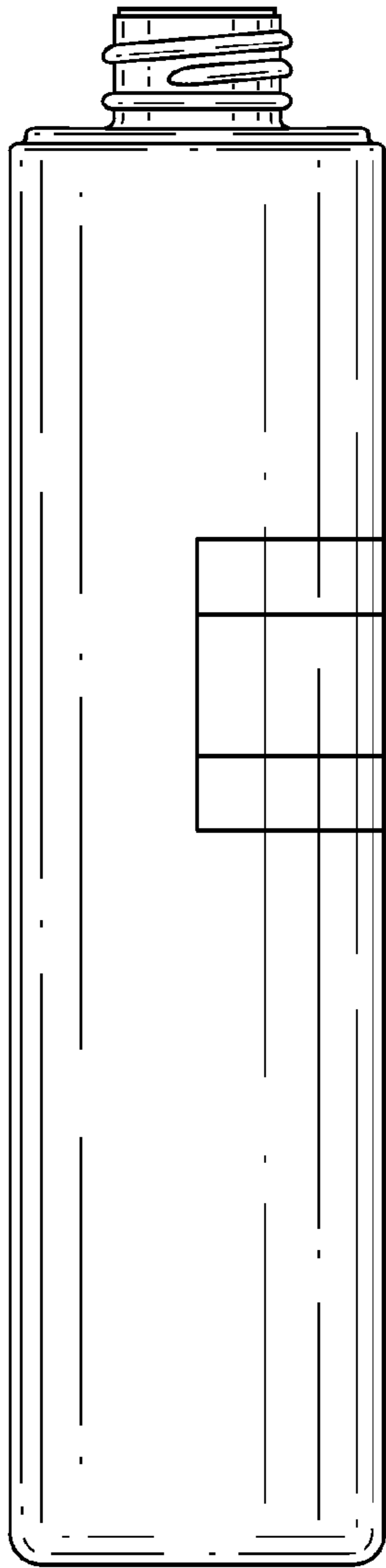

Fig. 32

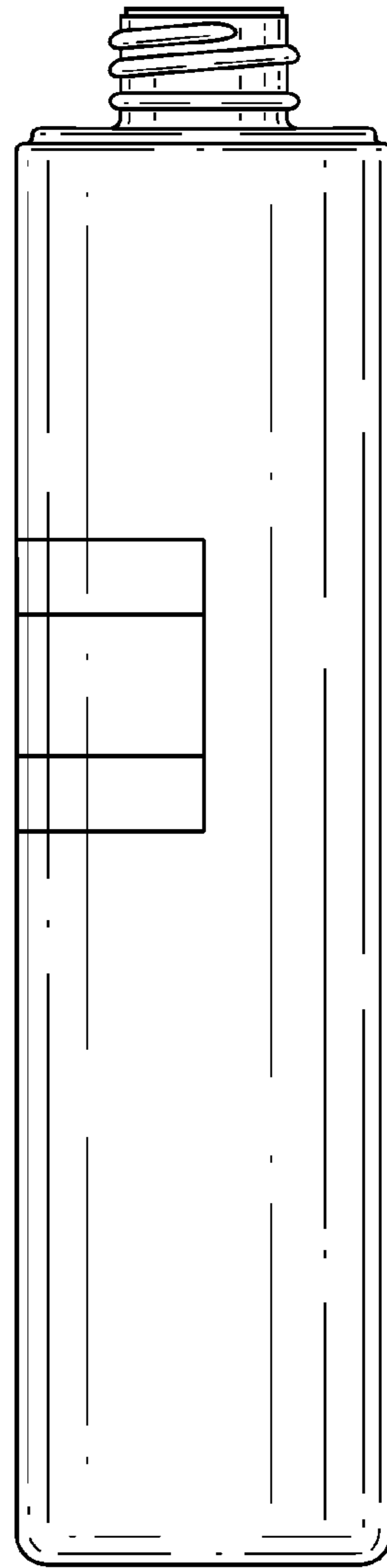

Fig. 33

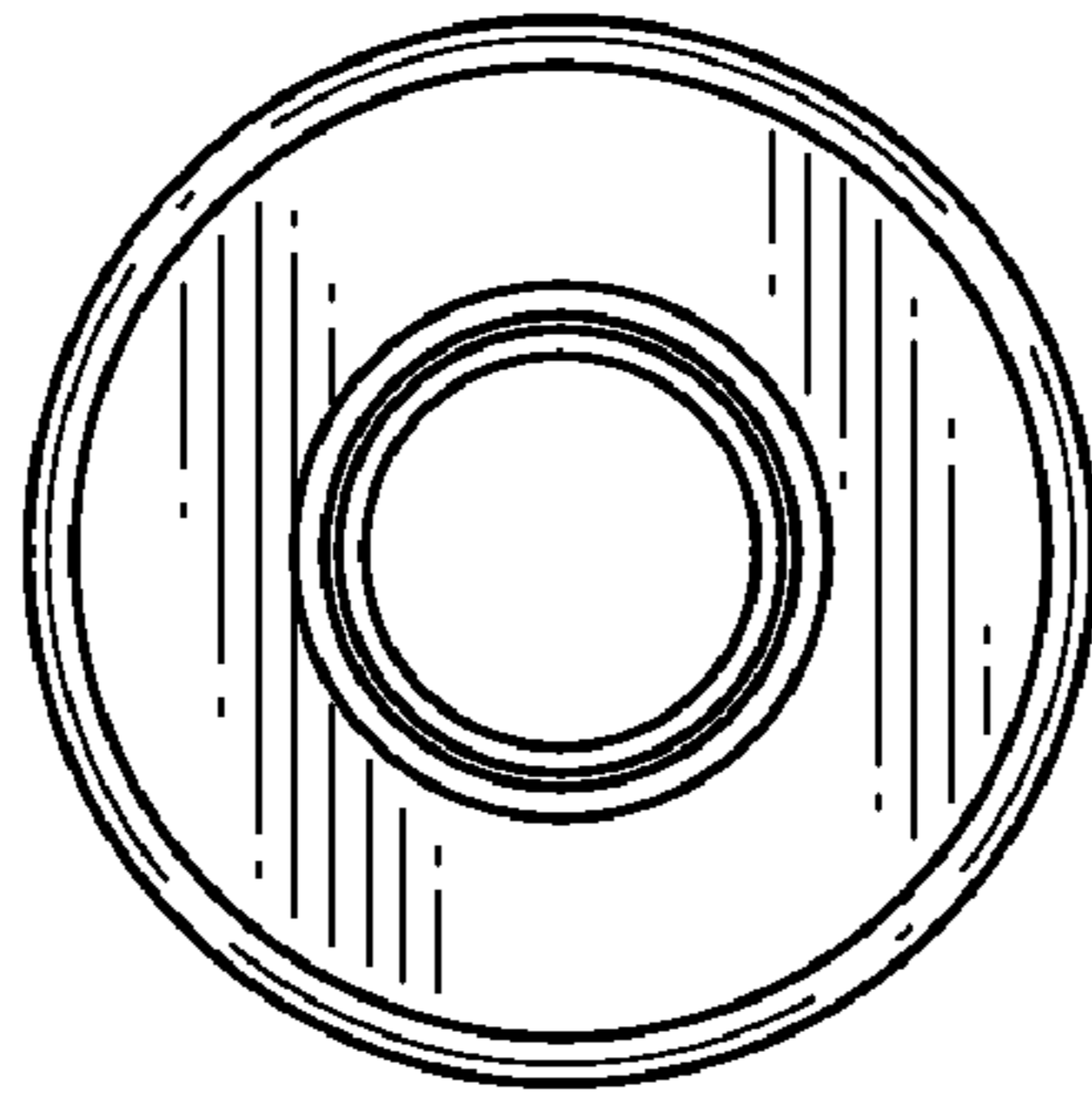

Fig. 34

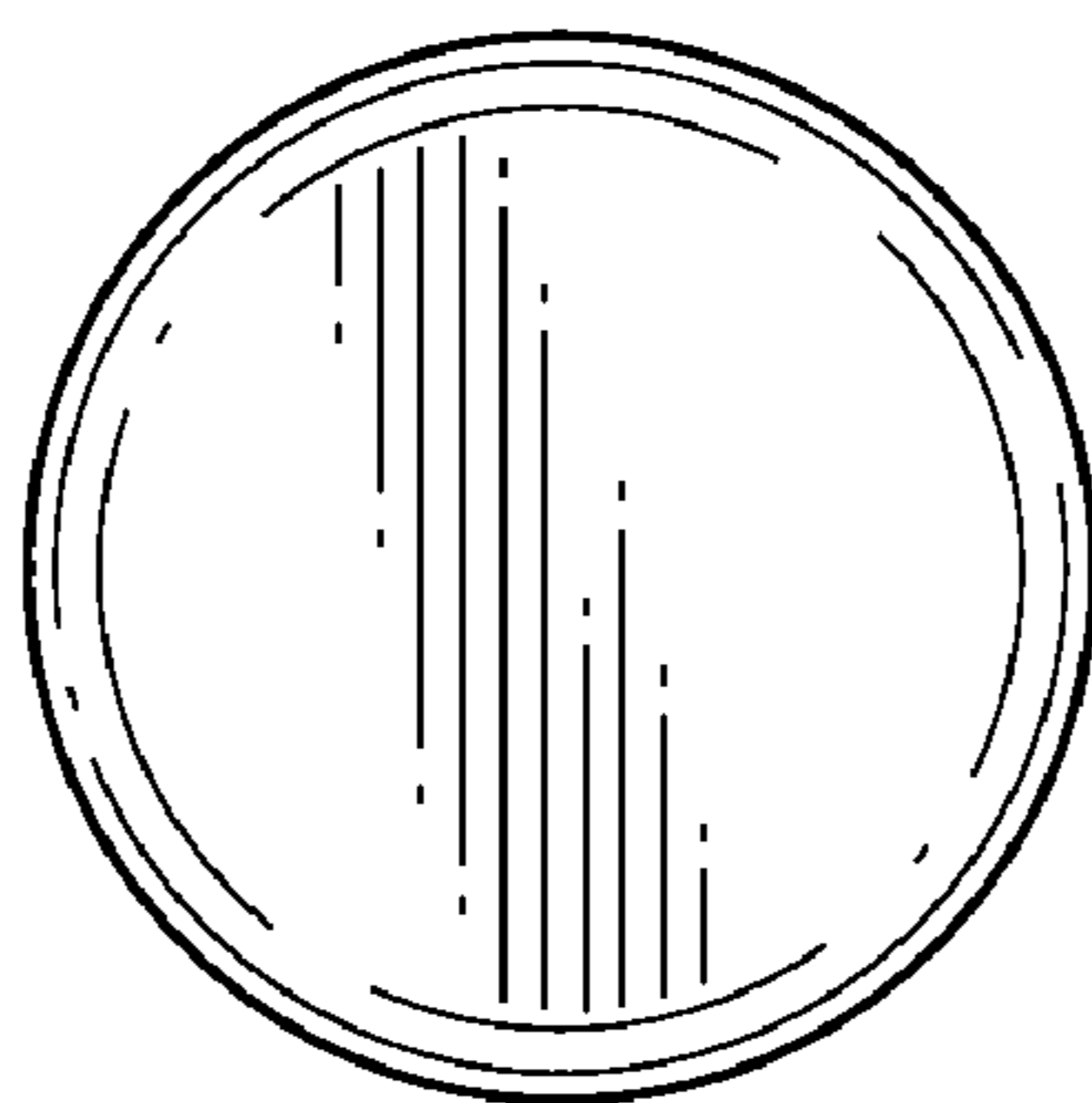

Fig. 35

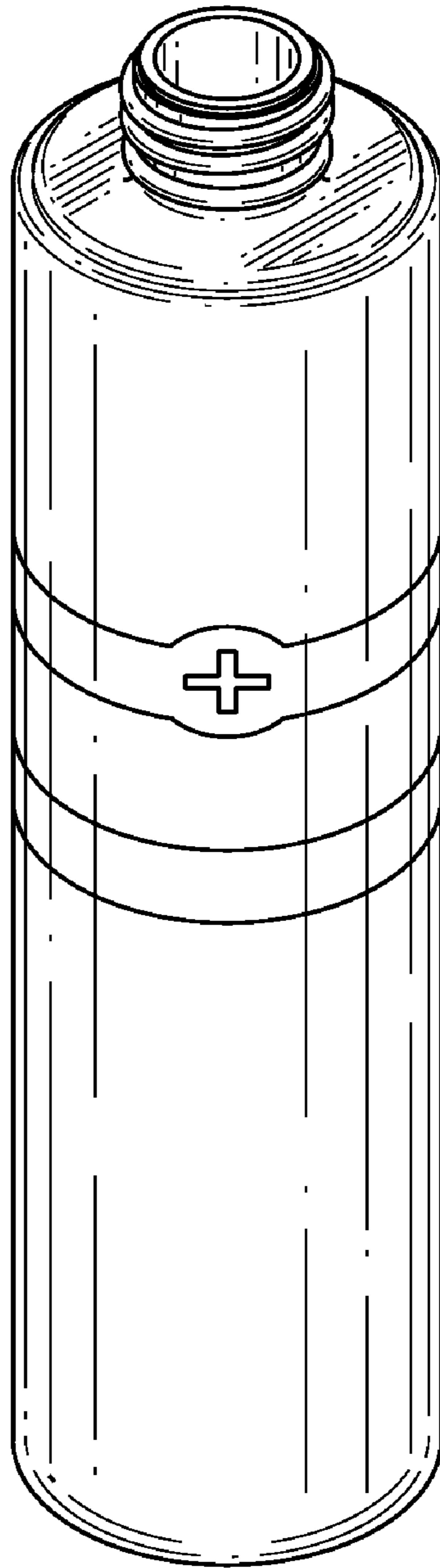

Fig. 36

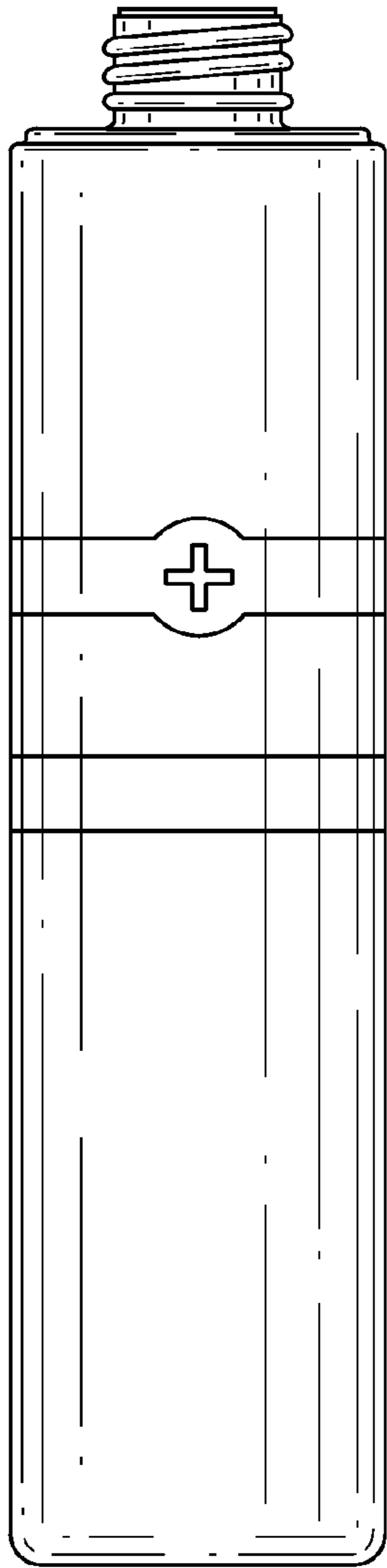

Fig. 37

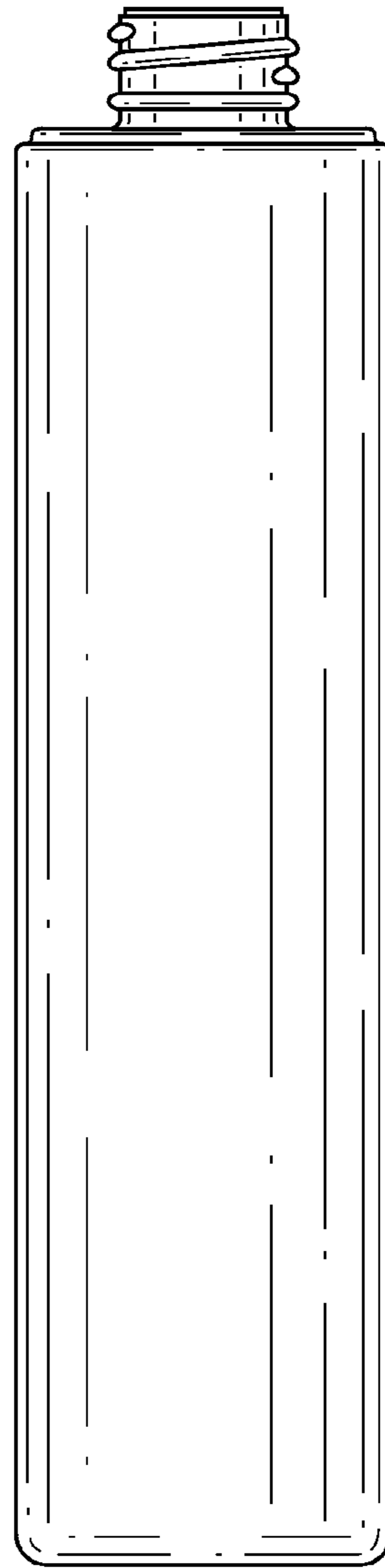

Fig. 38

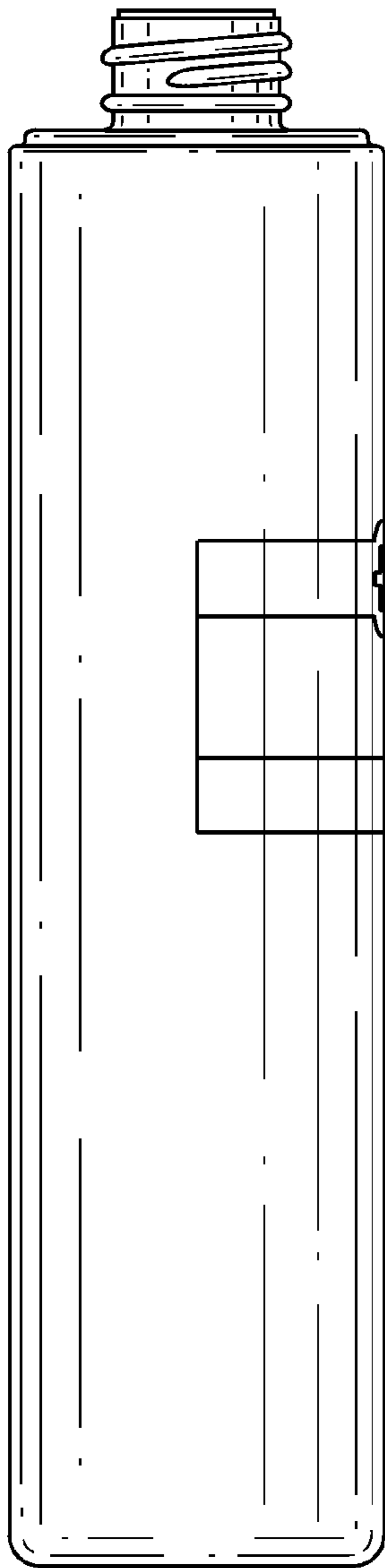

Fig. 39

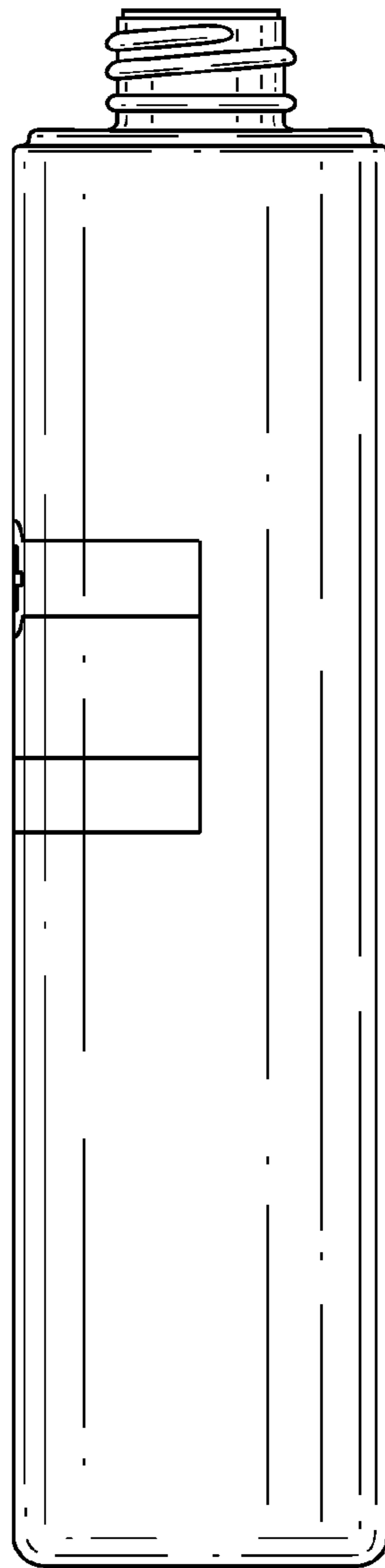

Fig. 40

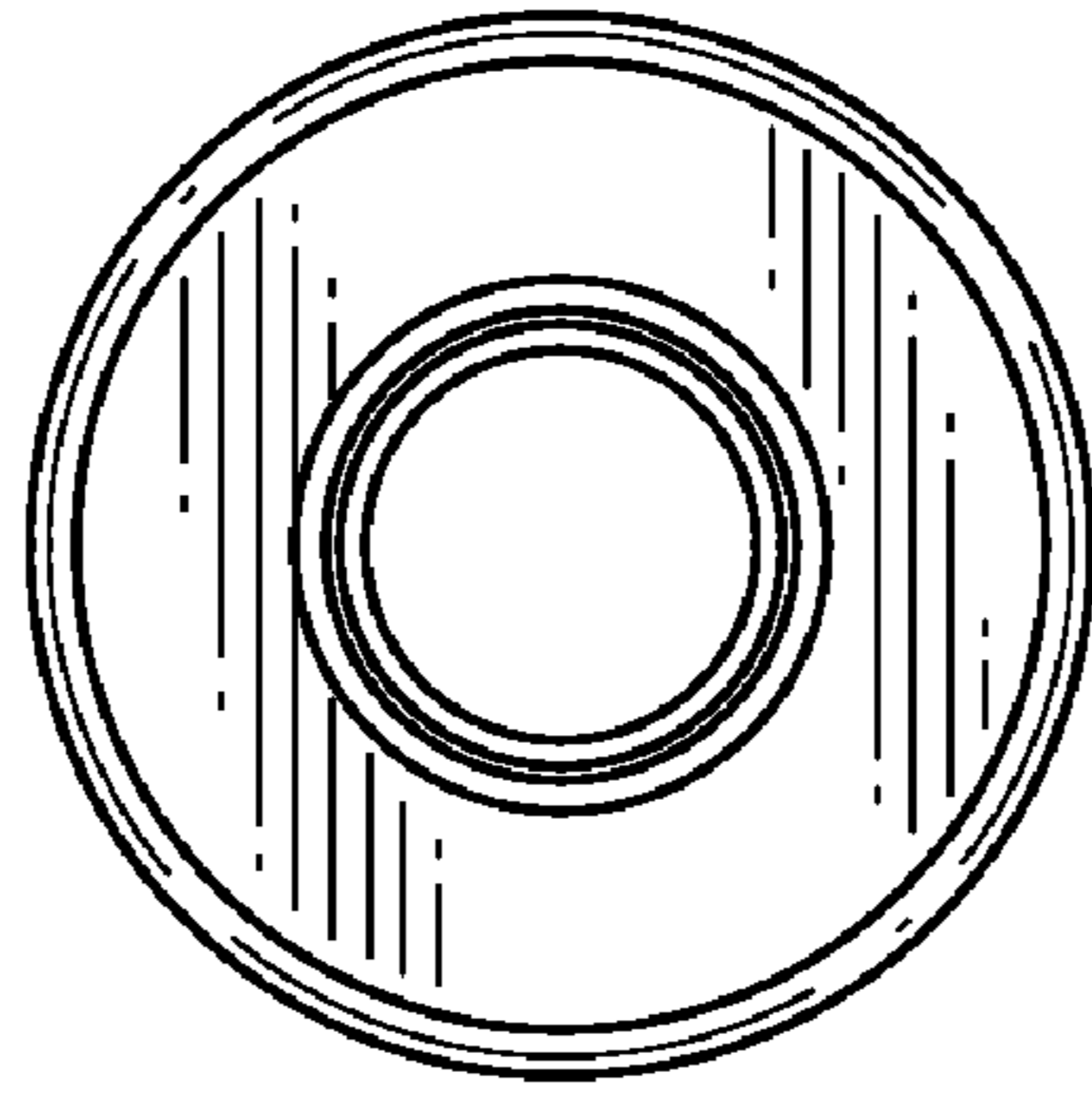

Fig. 41

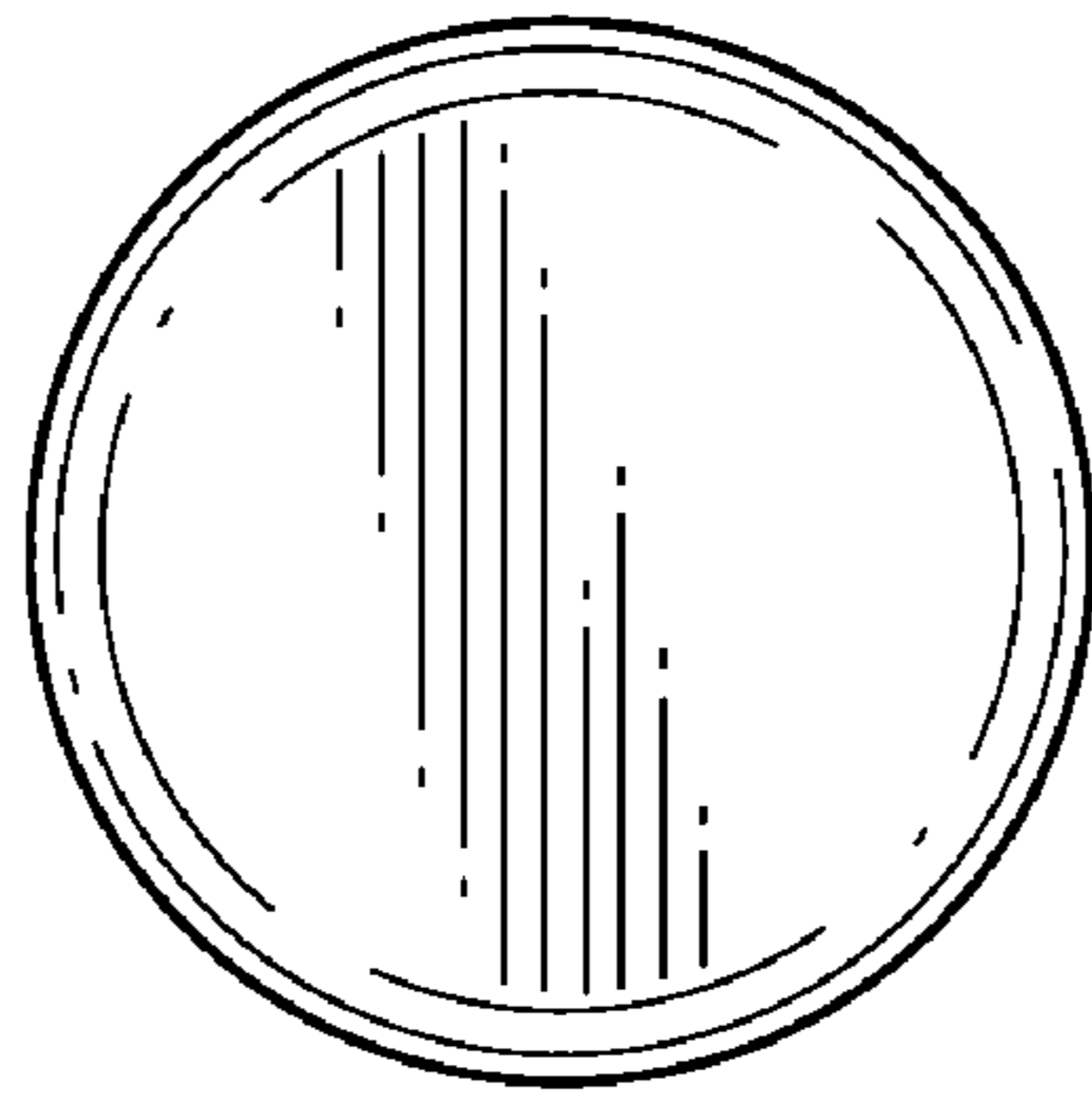

Fig. 42

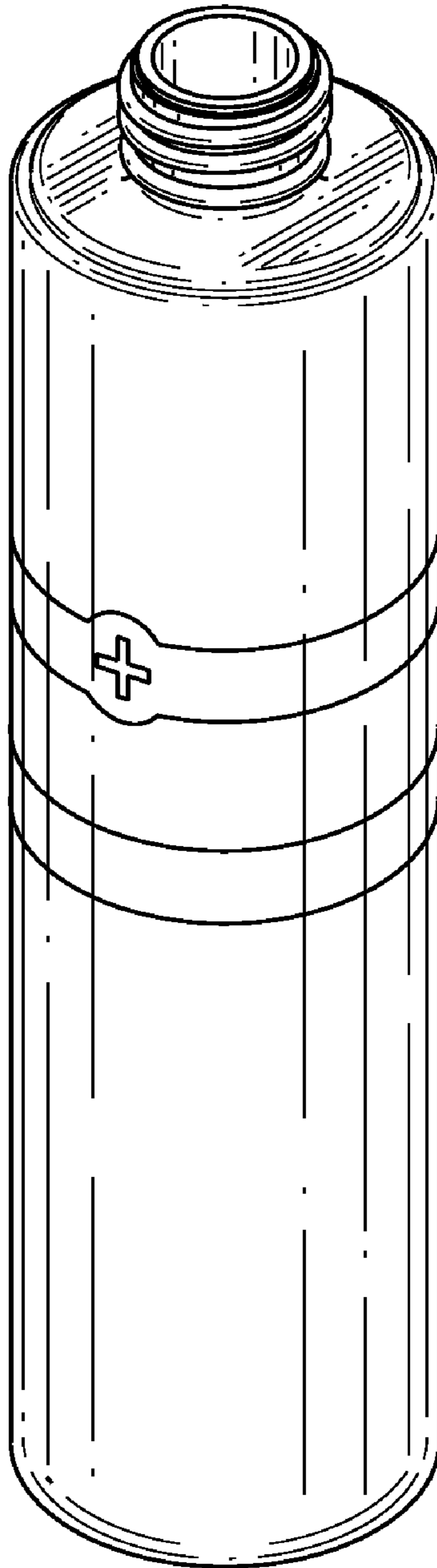

Fig. 43

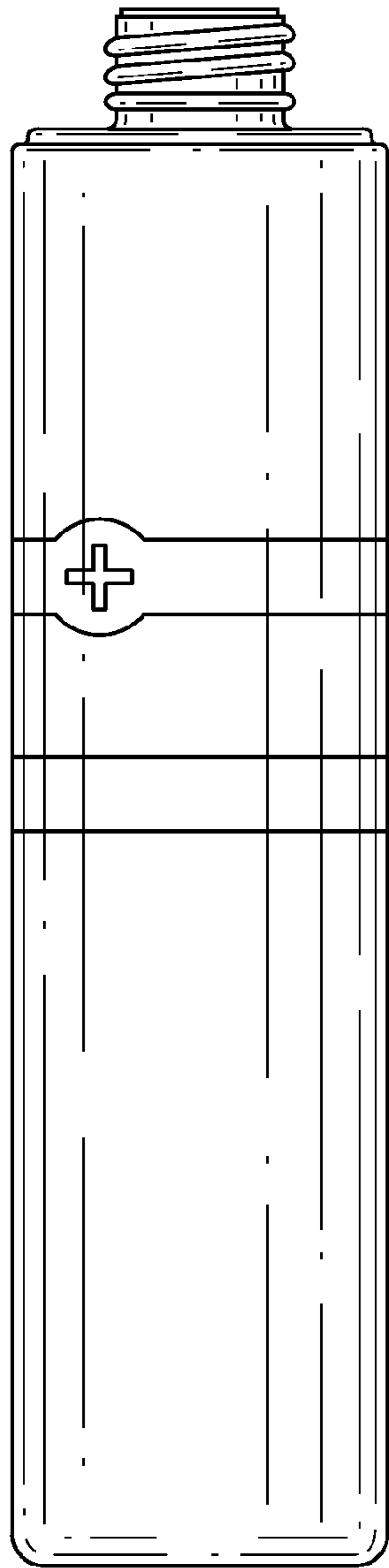

Fig. 44

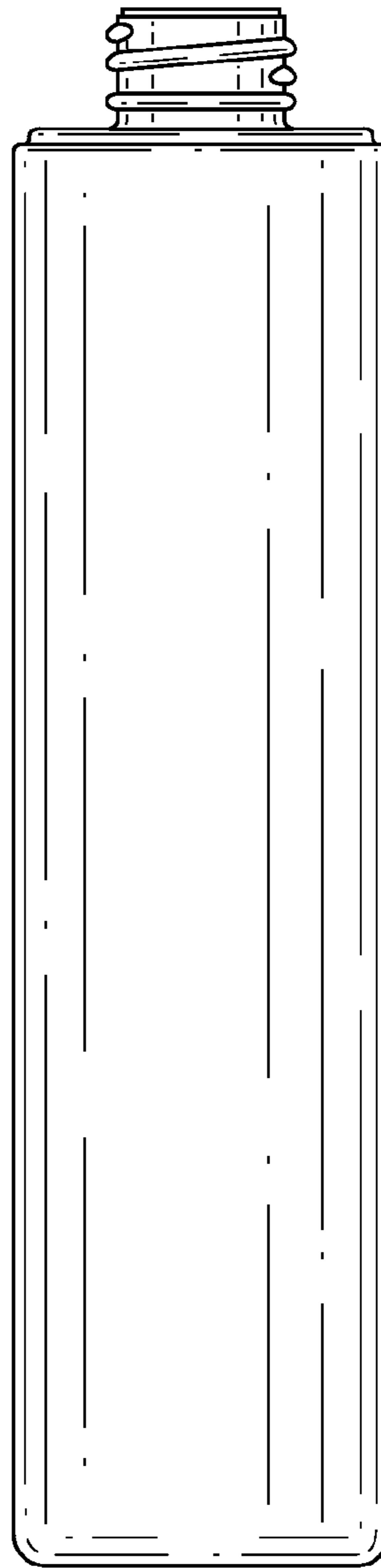

Fig. 45

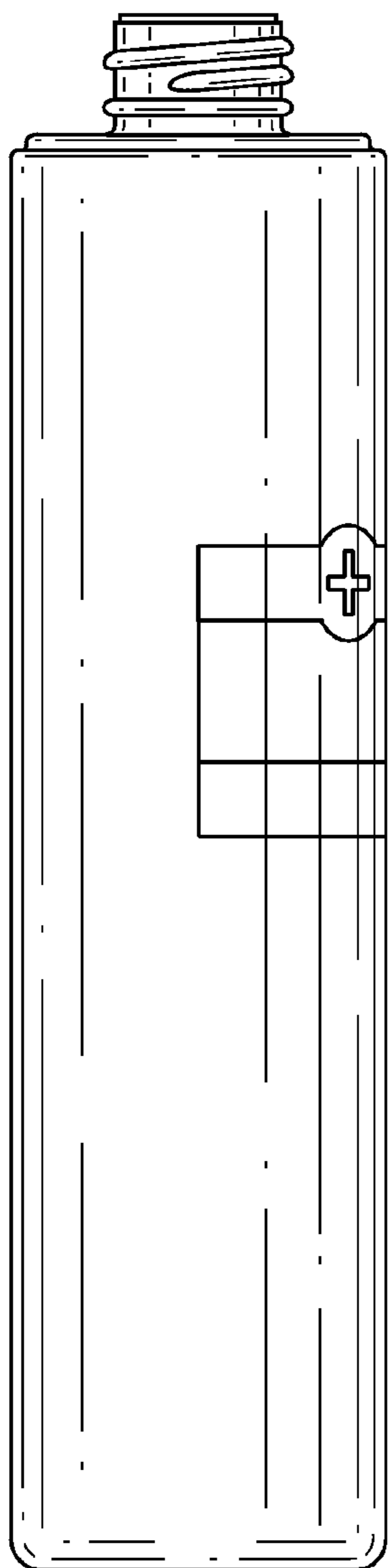

Fig. 46

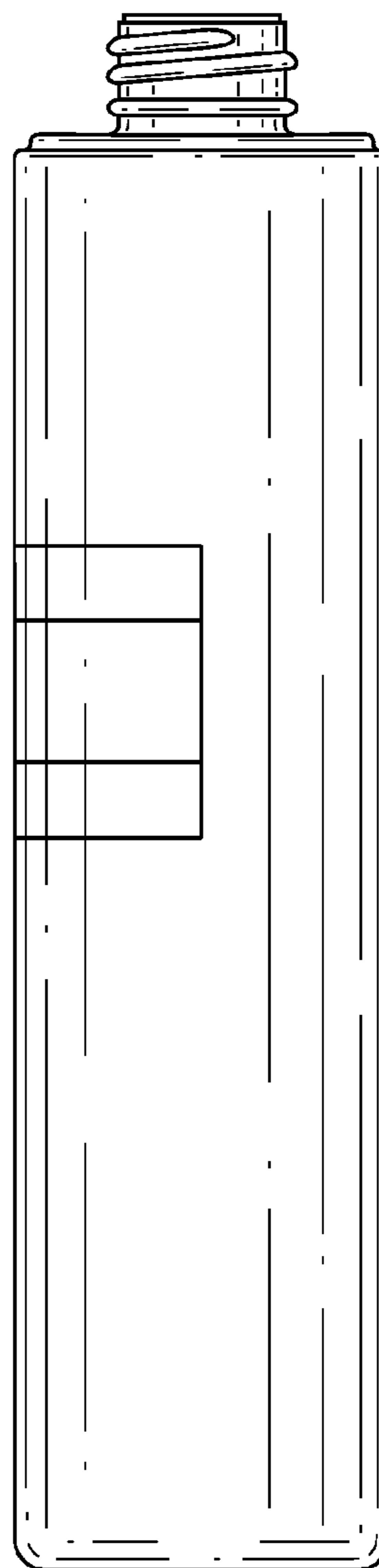

Fig. 47

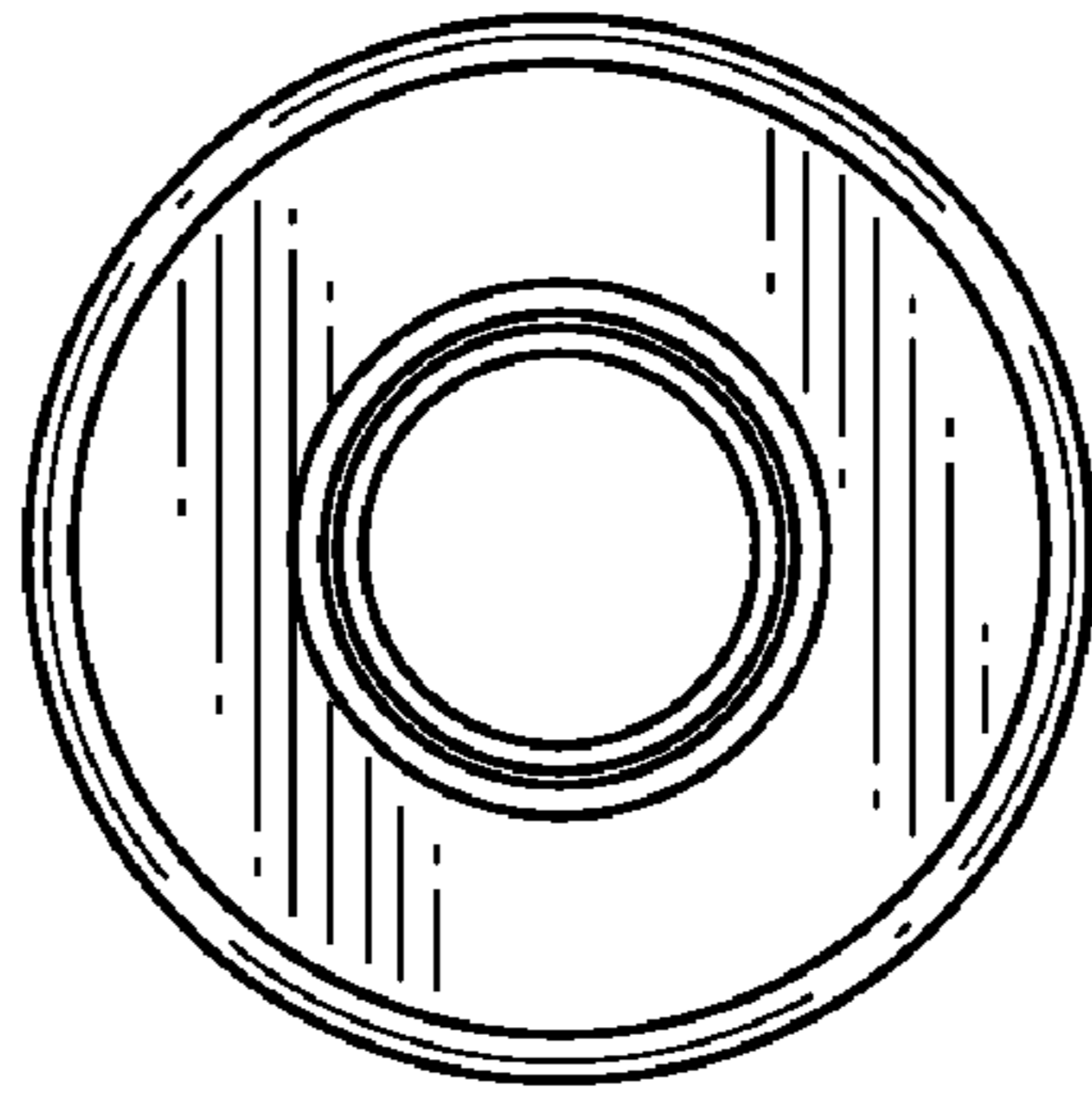

Fig. 48

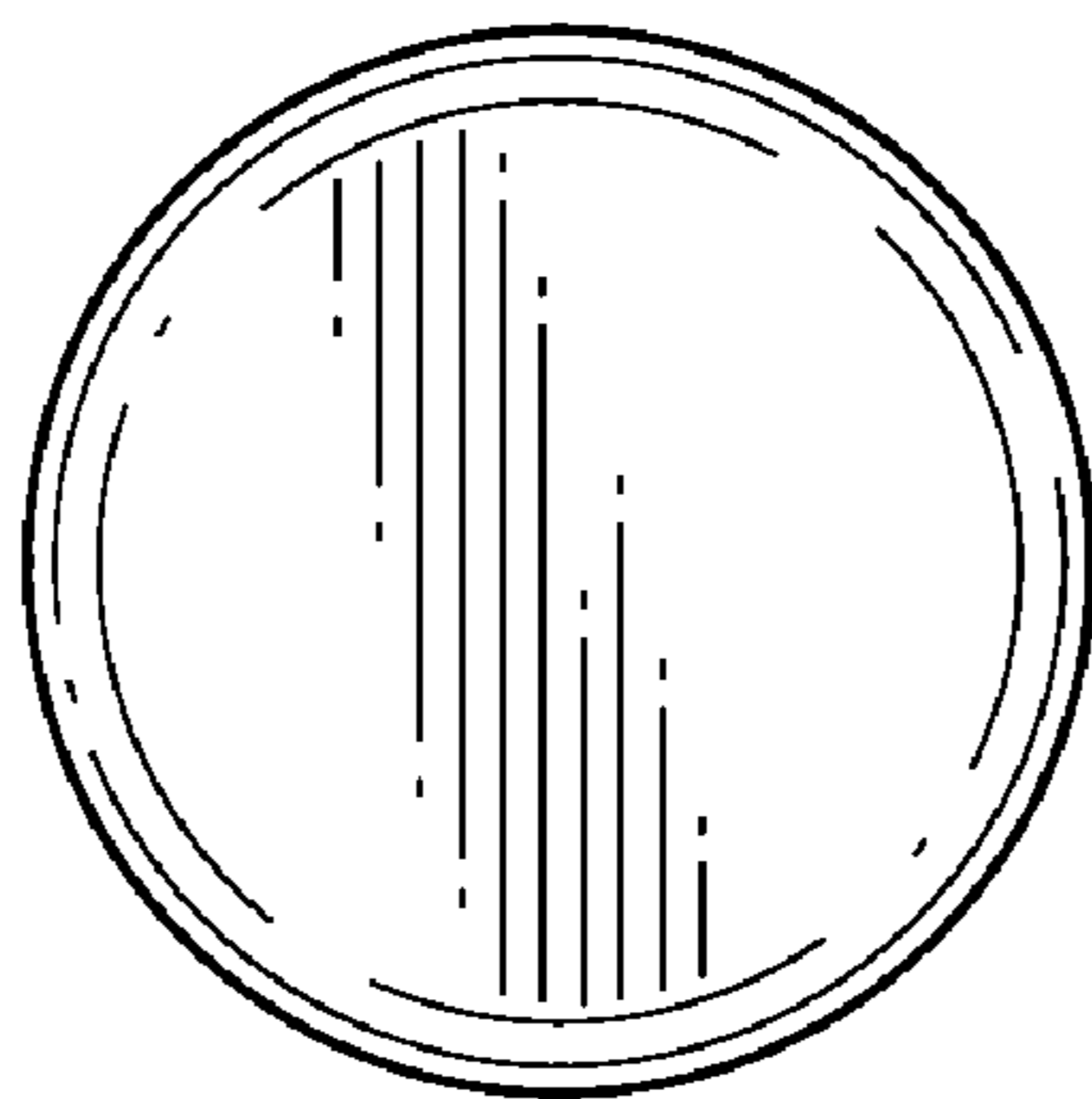

Fig. 49

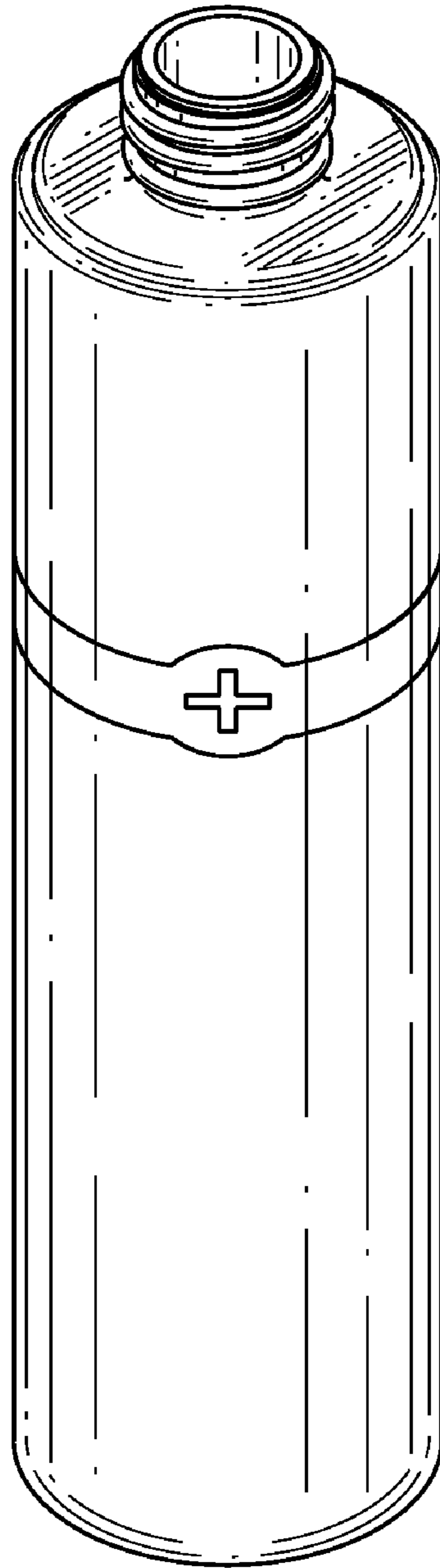

Fig. 50

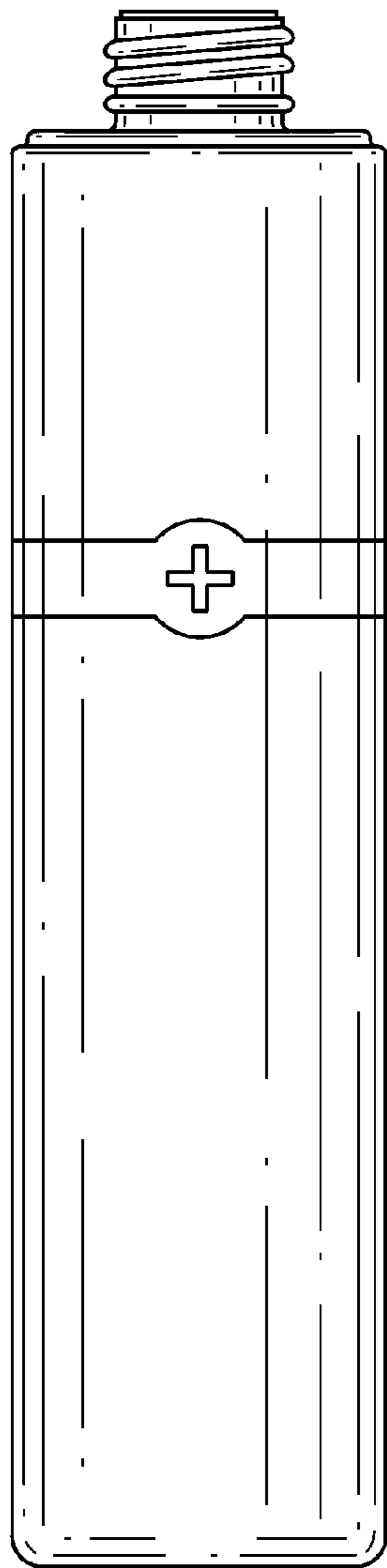

Fig. 51

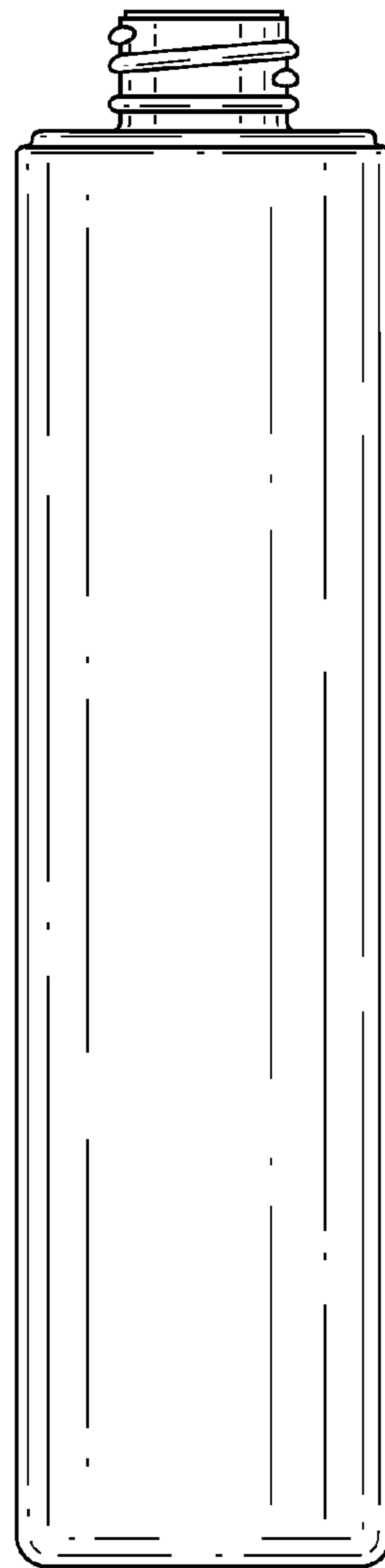

Fig. 52

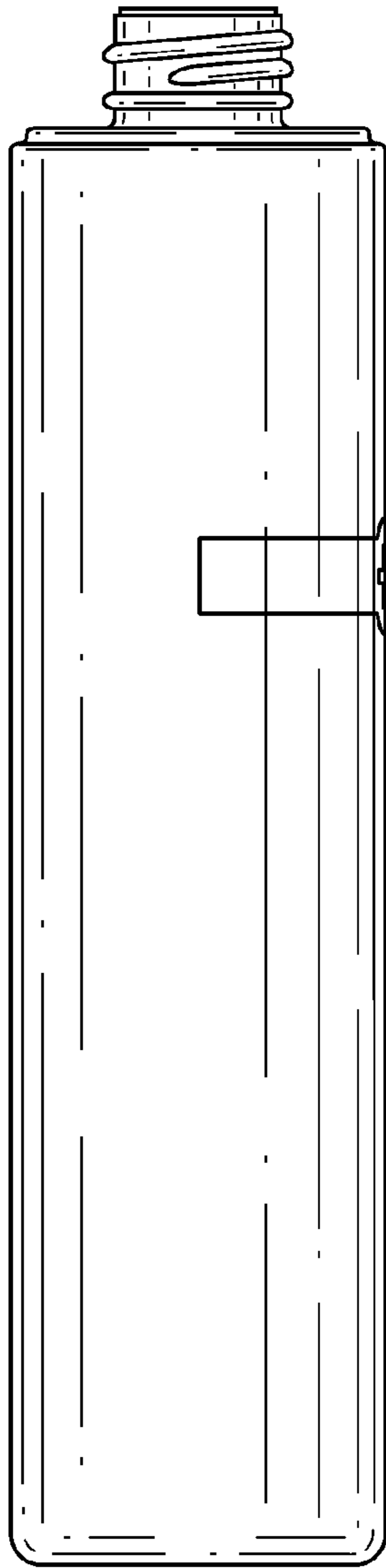

Fig. 53

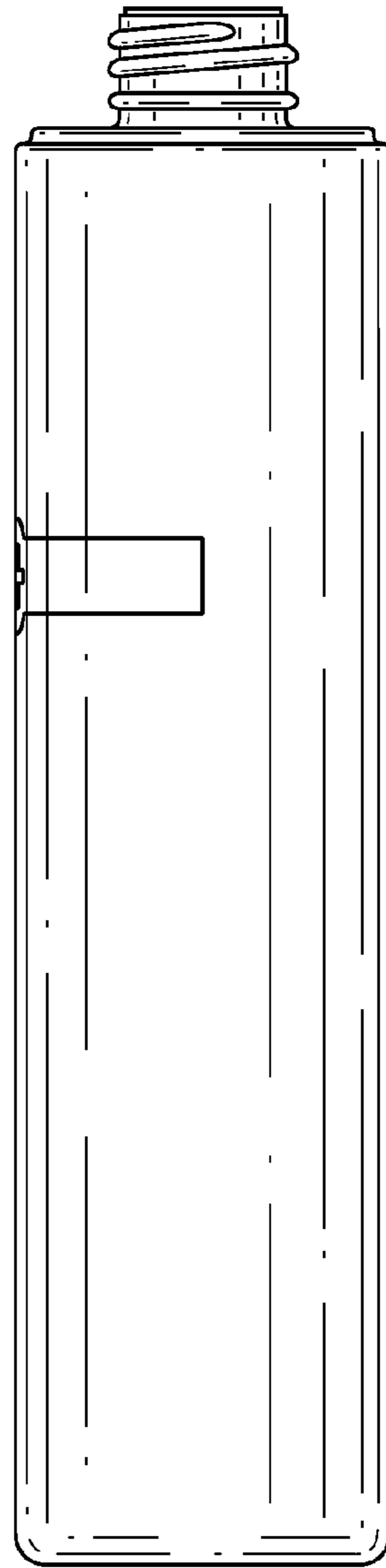

Fig. 54

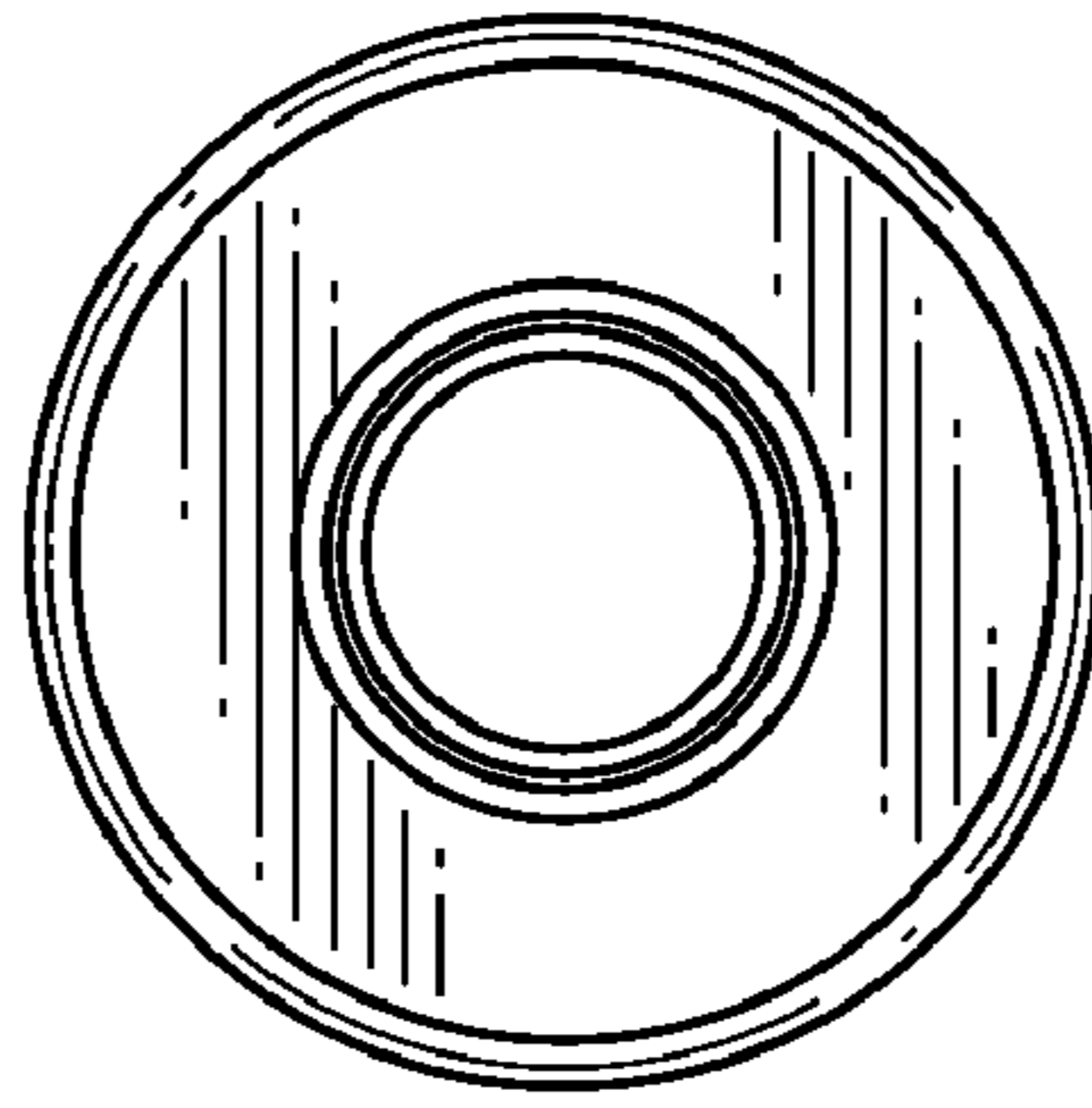

Fig. 55

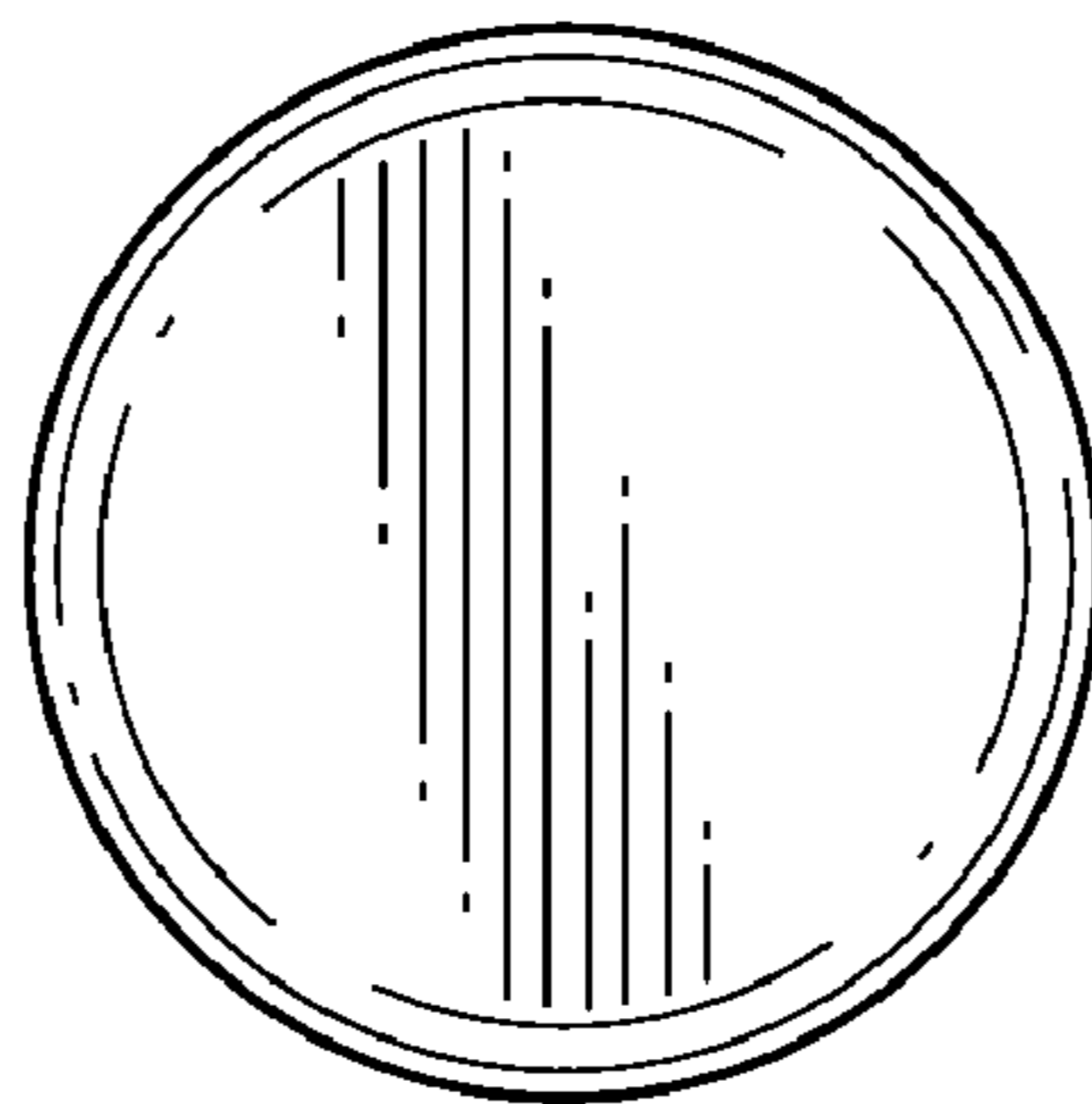

Fig. 56

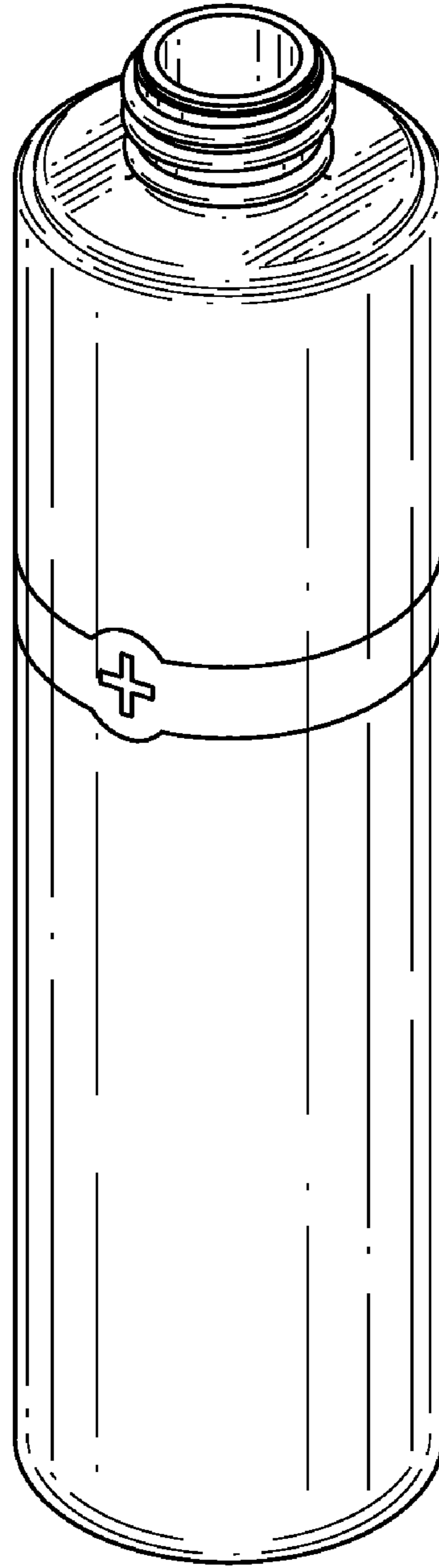

Fig. 57

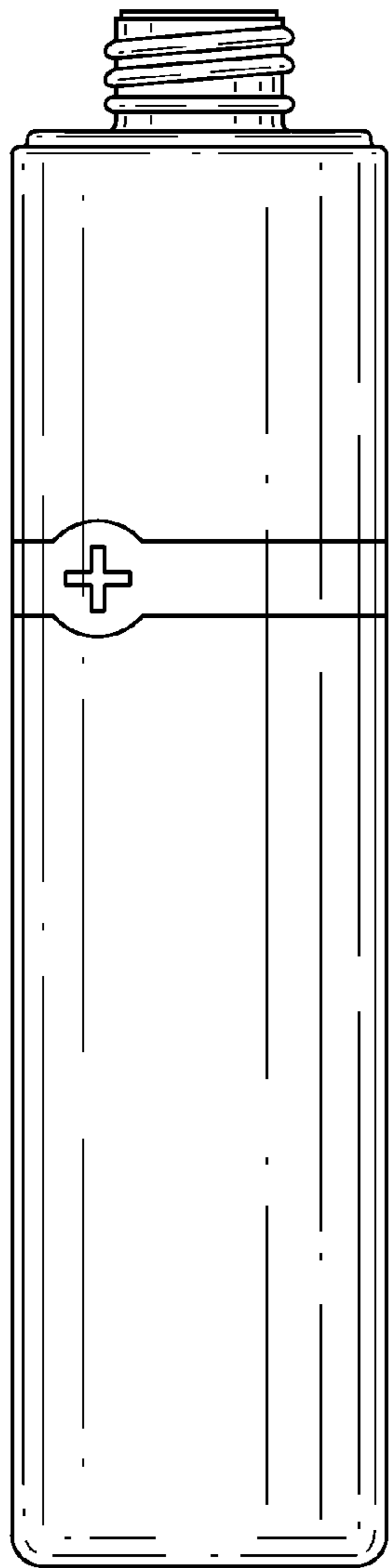

Fig. 58

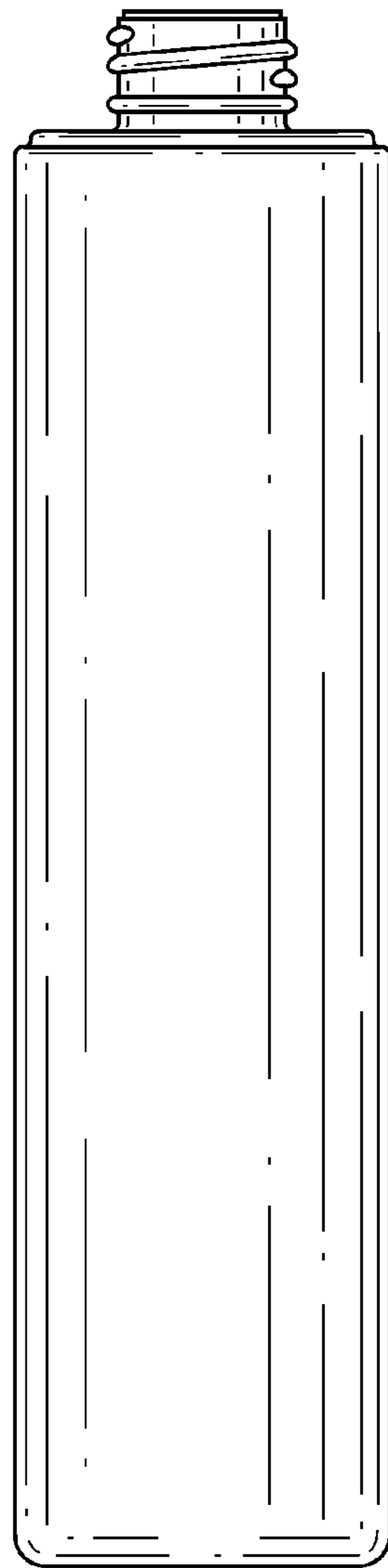

Fig. 59

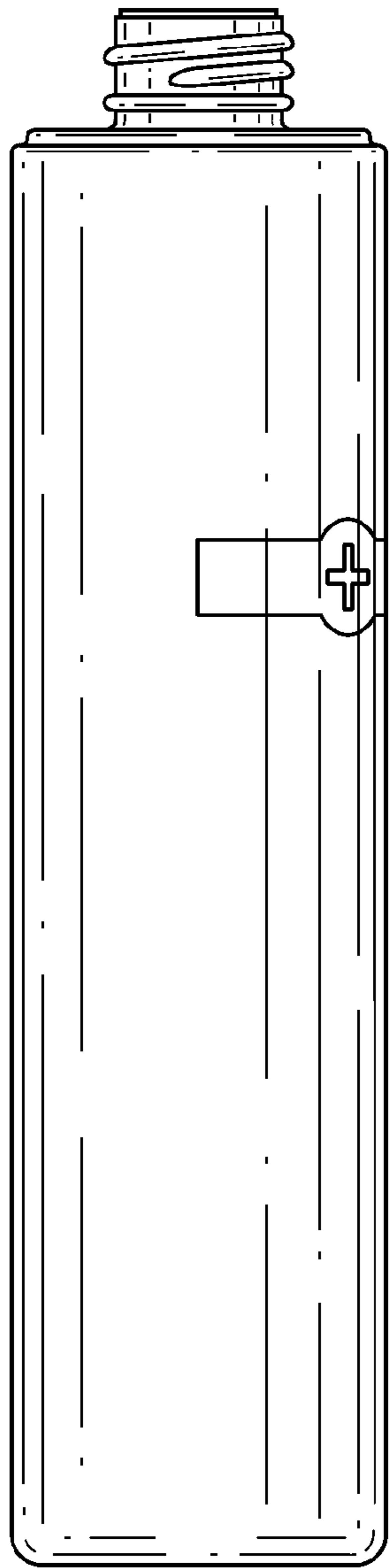

Fig. 60

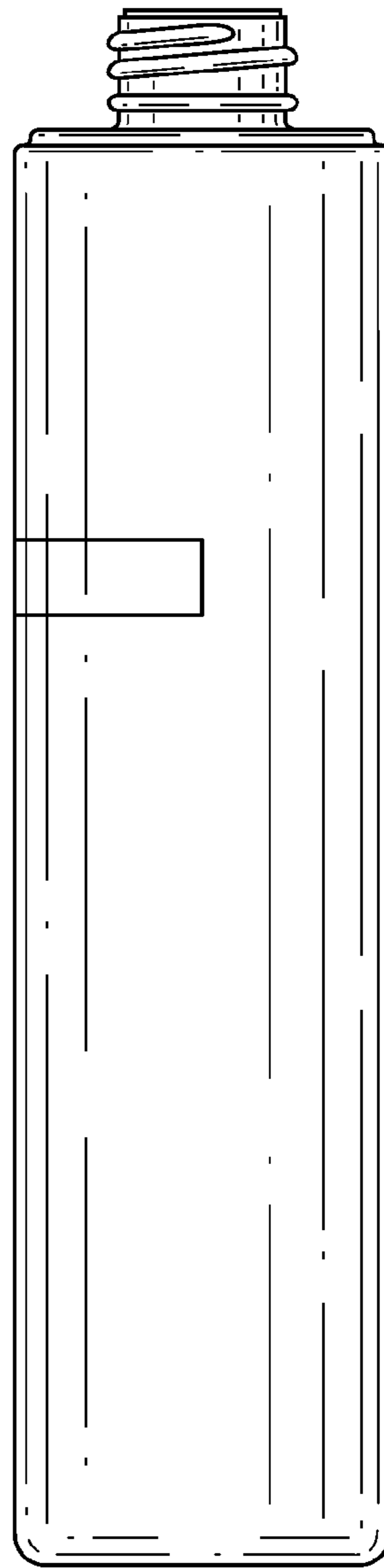

Fig. 61

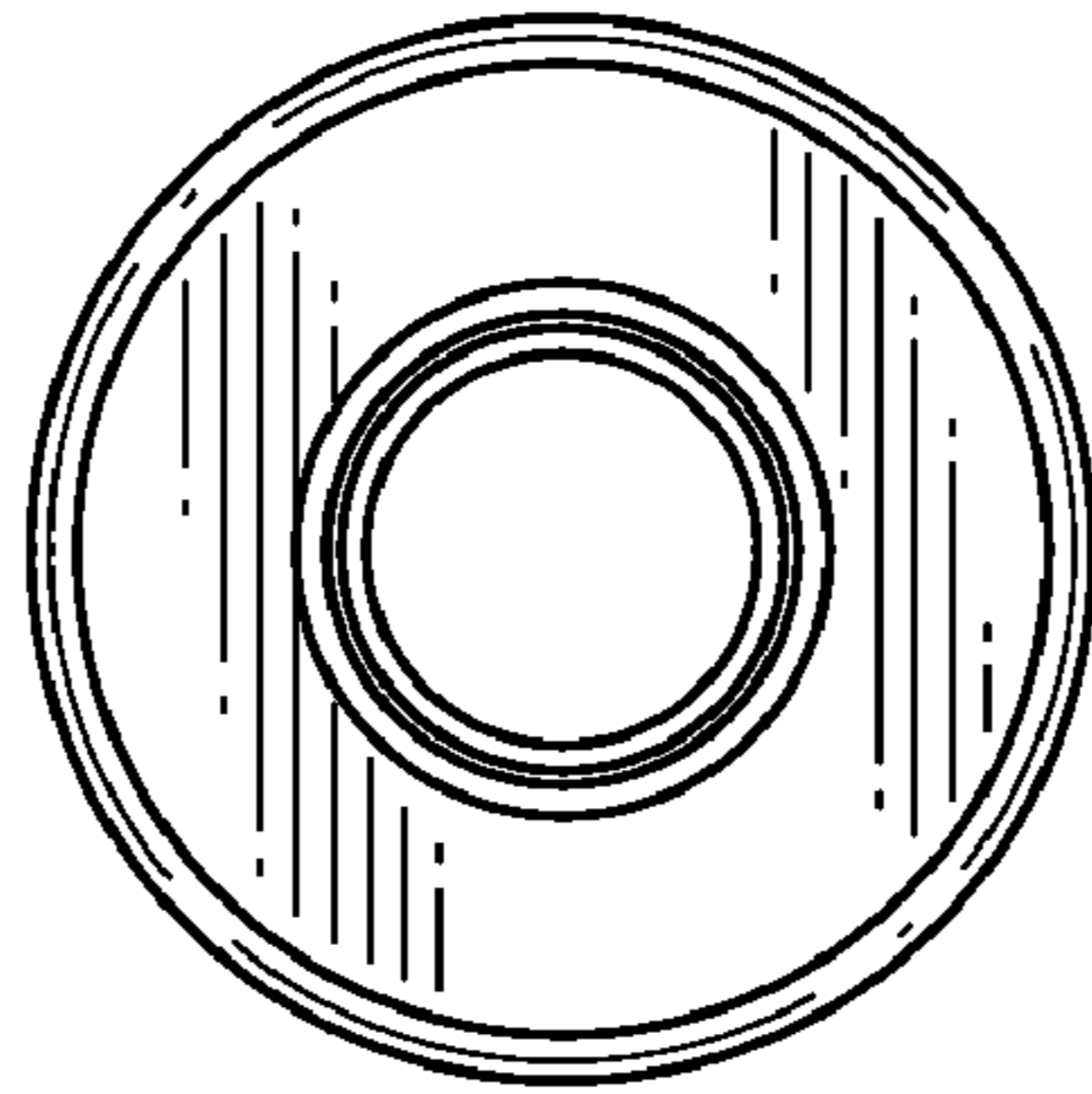

Fig. 62

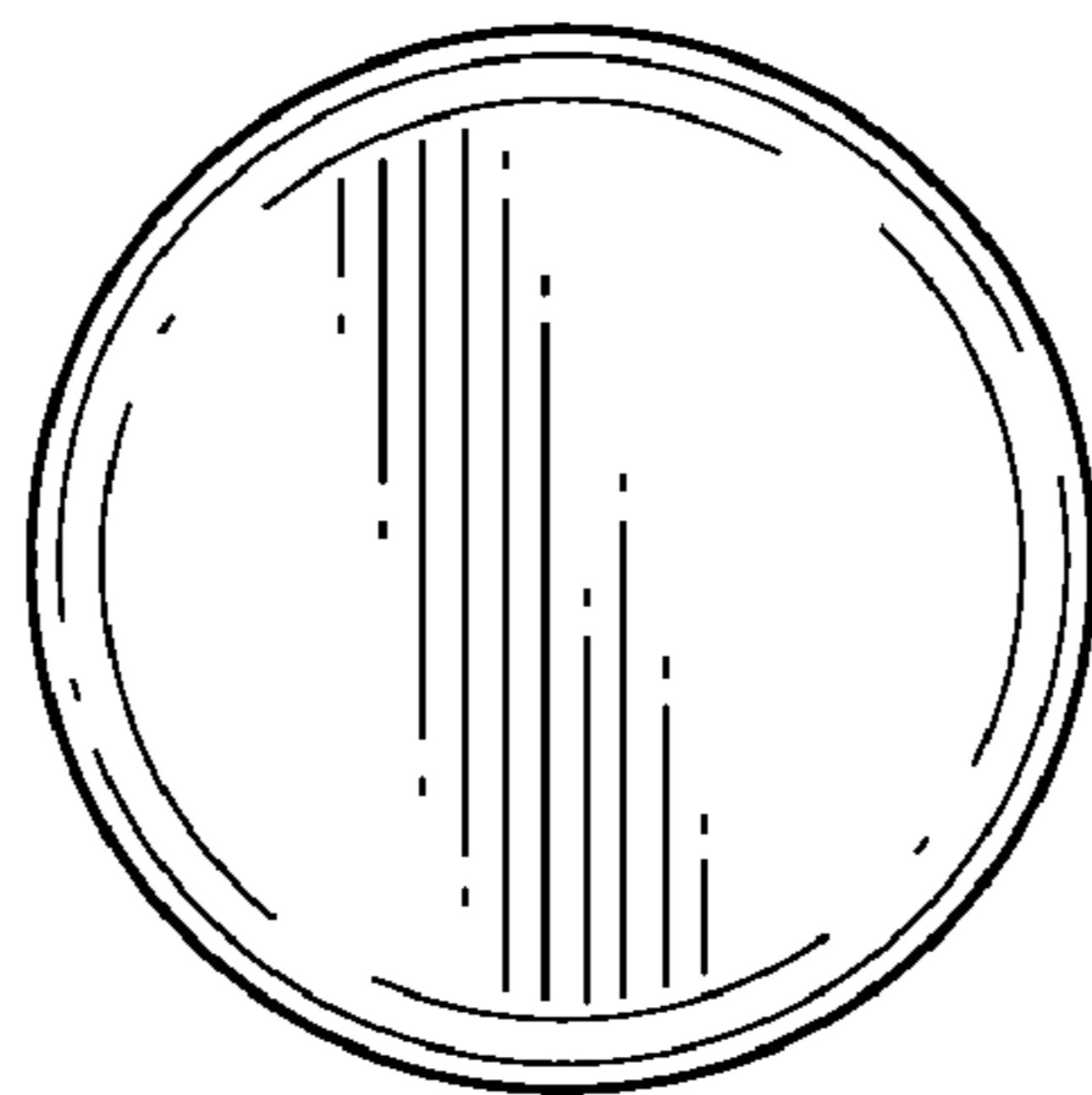

Fig. 63