



US00D617185S

(12) **United States Design Patent**
Wager

(10) **Patent No.:** **US D617,185 S**

(45) **Date of Patent:** **** Jun. 8, 2010**

(54) **PACKAGING**

(75) Inventor: **Sibylle Wager**, Heilbronn (DE)

(73) Assignee: **Conopco, Inc.**, Englewood Cliffs, NJ
(US)

(**) Term: **14 Years**

(21) Appl. No.: **29/350,513**

(22) Filed: **Nov. 18, 2009**

(51) **LOC (9) Cl.** **09-03**

(52) **U.S. Cl.** **D9/431**

(58) **Field of Classification Search** D9/430-433,
D9/414, 418, 420-424; D3/272; 206/267,
206/269, 270, 273, 299, 737, 740, 822; 229/100,
229/101, 101.3, 106, 108-112, 114-117,
229/117.05-117.09, 117.24-117.26, 221,
229/222, 227, 902, 939, 941, 942

See application file for complete search history.

(56) **References Cited**

U.S. PATENT DOCUMENTS

1,380,561	A *	6/1921	Kaufmann	206/765
1,501,016	A *	7/1924	Young	206/765
1,724,636	A *	8/1929	Bell	229/112
2,022,305	A *	11/1935	Wellman	493/59
2,800,268	A *	7/1957	Mathews	229/117.13
2,883,042	A *	4/1959	Richer	206/279
2,960,149	A *	11/1960	Throssel	297/440.12
2,992,829	A *	7/1961	Hopkins	273/157 R
3,765,529	A *	10/1973	Mueller	206/779
D278,126	S *	3/1985	Benham	D9/418

4,699,312	A *	10/1987	Owen	232/2
D294,805	S *	3/1988	Boyer	D9/415
4,962,859	A *	10/1990	Kump	211/50
D320,556	S *	10/1991	Fairhurst	D9/414
6,227,438	B1 *	5/2001	Hiltke	229/101
6,409,077	B1 *	6/2002	Telesca et al.	229/164
D494,760	S *	8/2004	Yuan	D3/313
7,007,825	B2 *	3/2006	Crosland et al.	222/105
D532,685	S *	11/2006	Reussner	D9/416
D571,198	S *	6/2008	Lee et al.	D9/432
D575,149	S *	8/2008	Baranowski	D9/432
2006/0124710	A1 *	6/2006	Sun	229/112

* cited by examiner

Primary Examiner—Robert M Spear

Assistant Examiner—Karen Acker

(74) *Attorney, Agent, or Firm*—Ellen Plotkin

(57) **CLAIM**

The ornamental design for a packaging, as shown and described.

DESCRIPTION

FIG. 1 is a front perspective view of a container showing my new design;

FIG. 2 is a front elevational view thereof;

FIG. 3 is a back elevational view thereof;

FIG. 4 is a left side elevational view thereof;

FIG. 5 is a right side elevational view thereof;

FIG. 6 is a top plan view thereof; and,

FIG. 7 is a bottom plan view thereof.

1 Claim, 3 Drawing Sheets

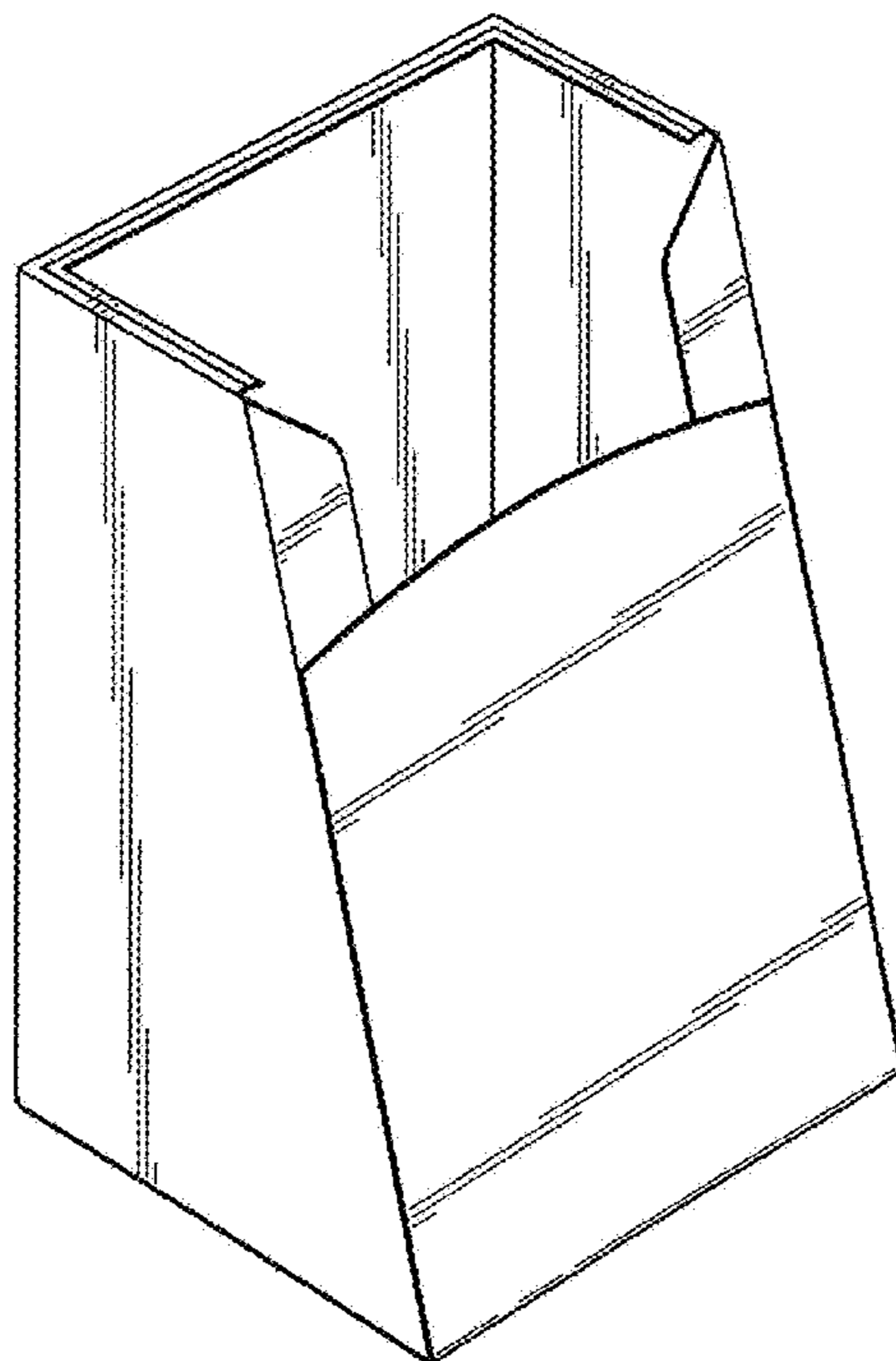

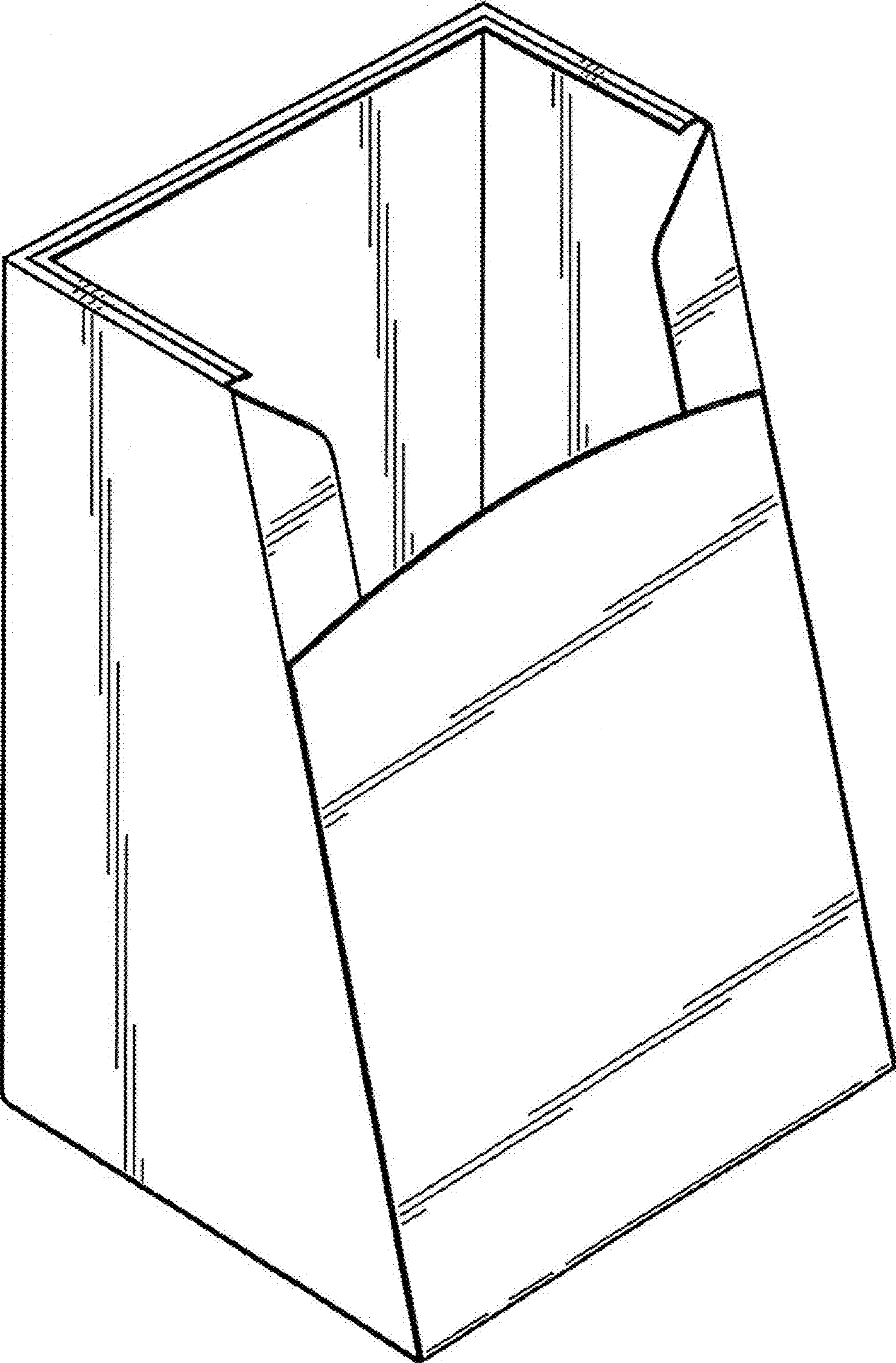

Fig. 1.

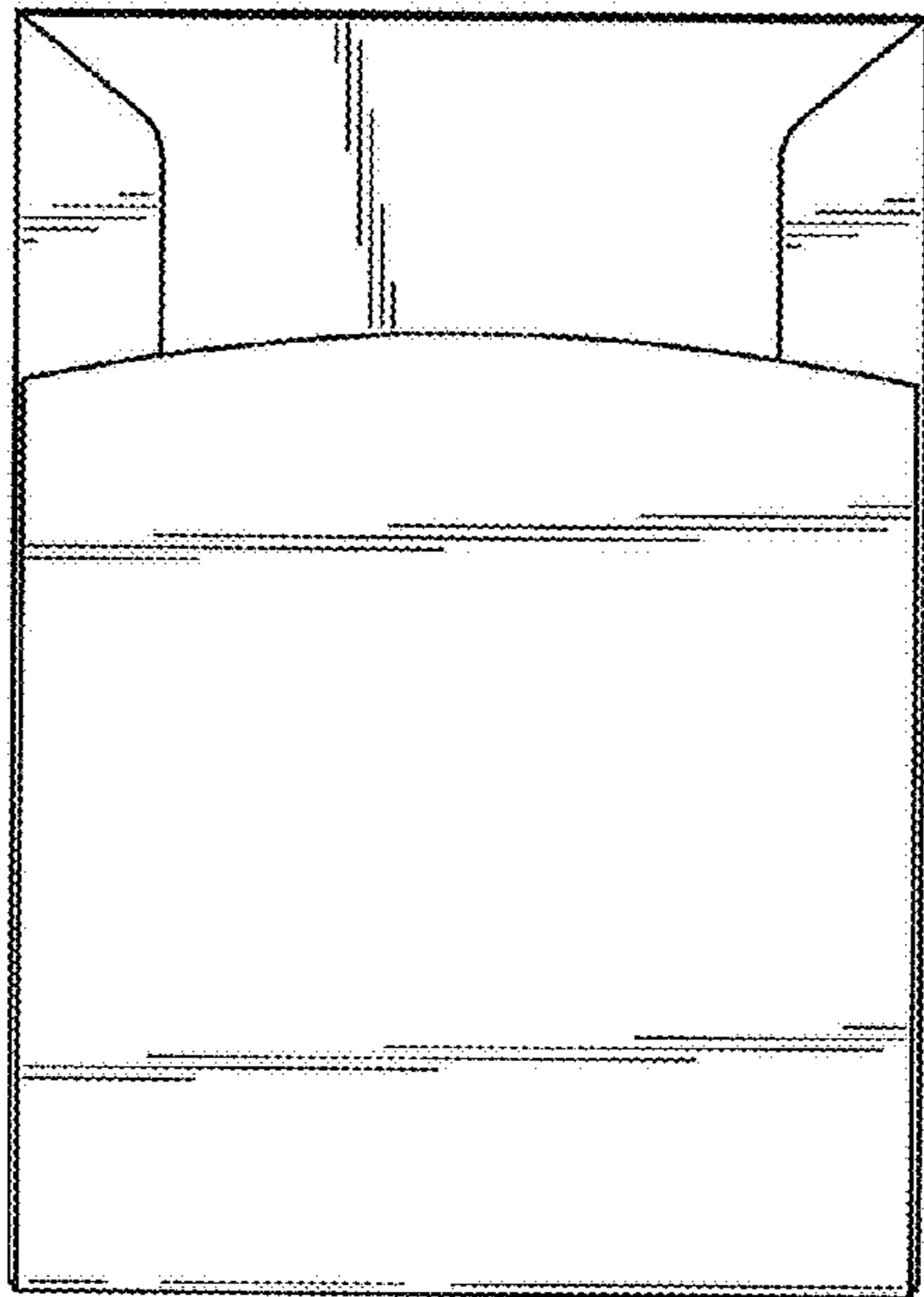

Fig. 2.

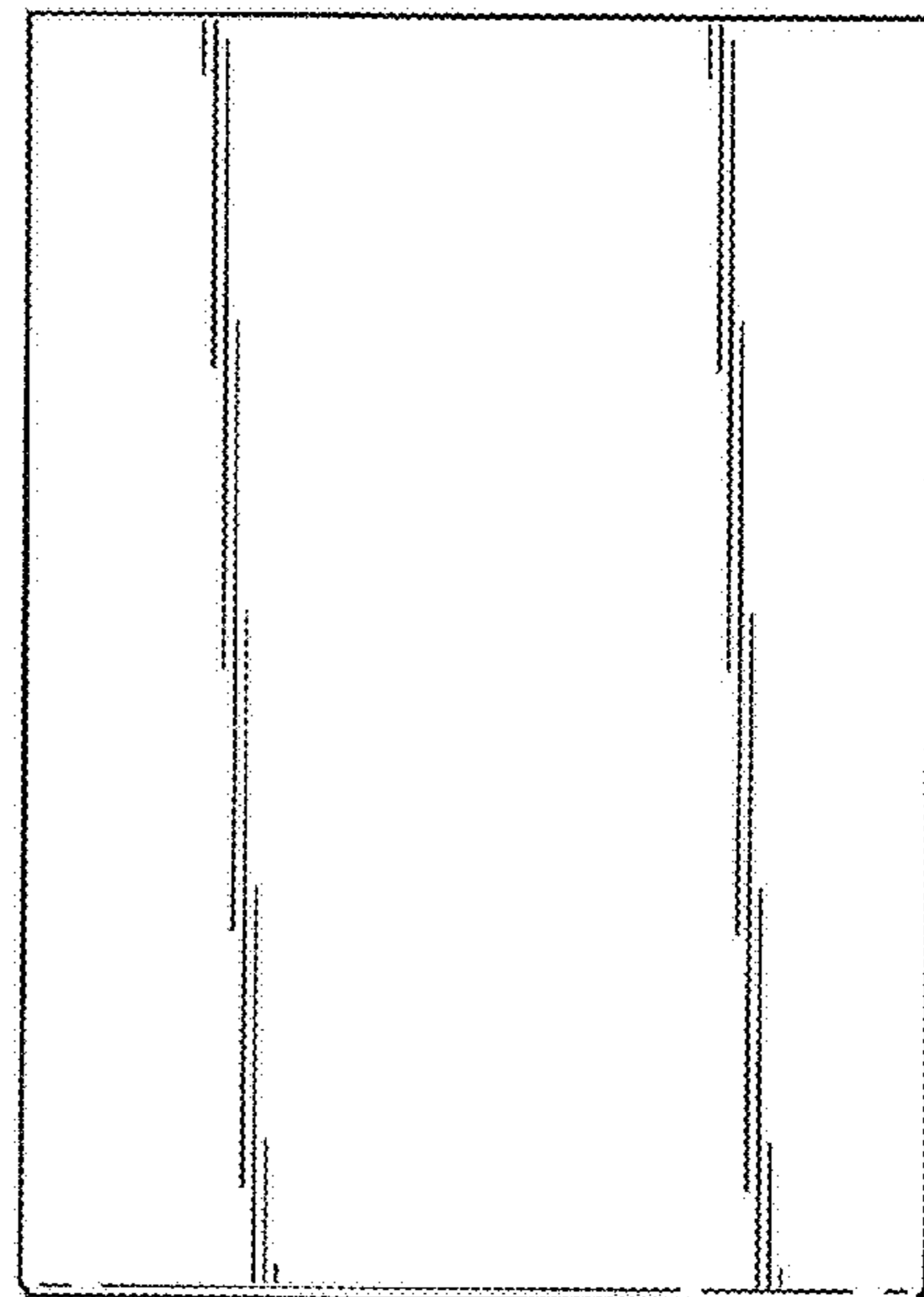

Fig. 3.

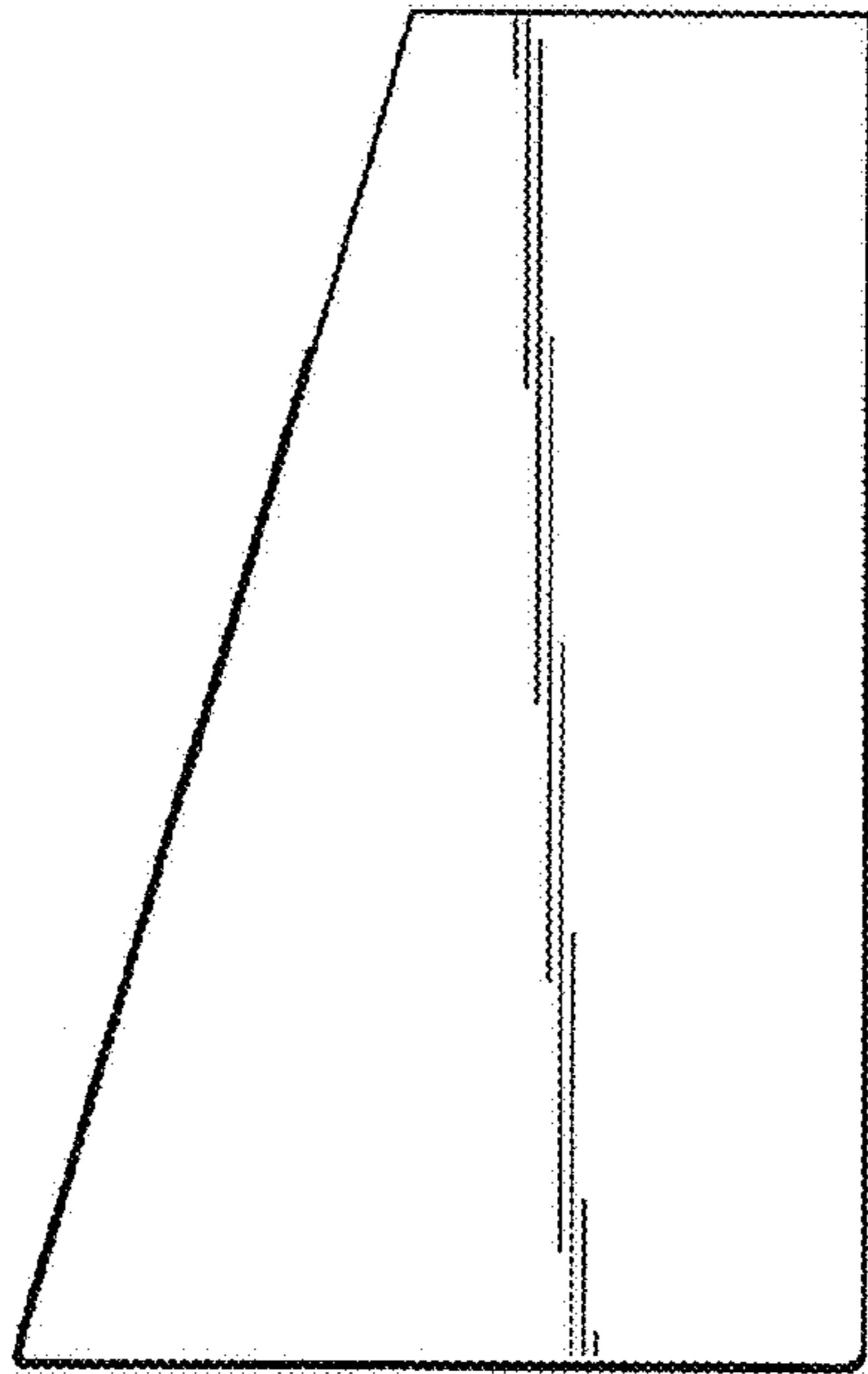

Fig.4.

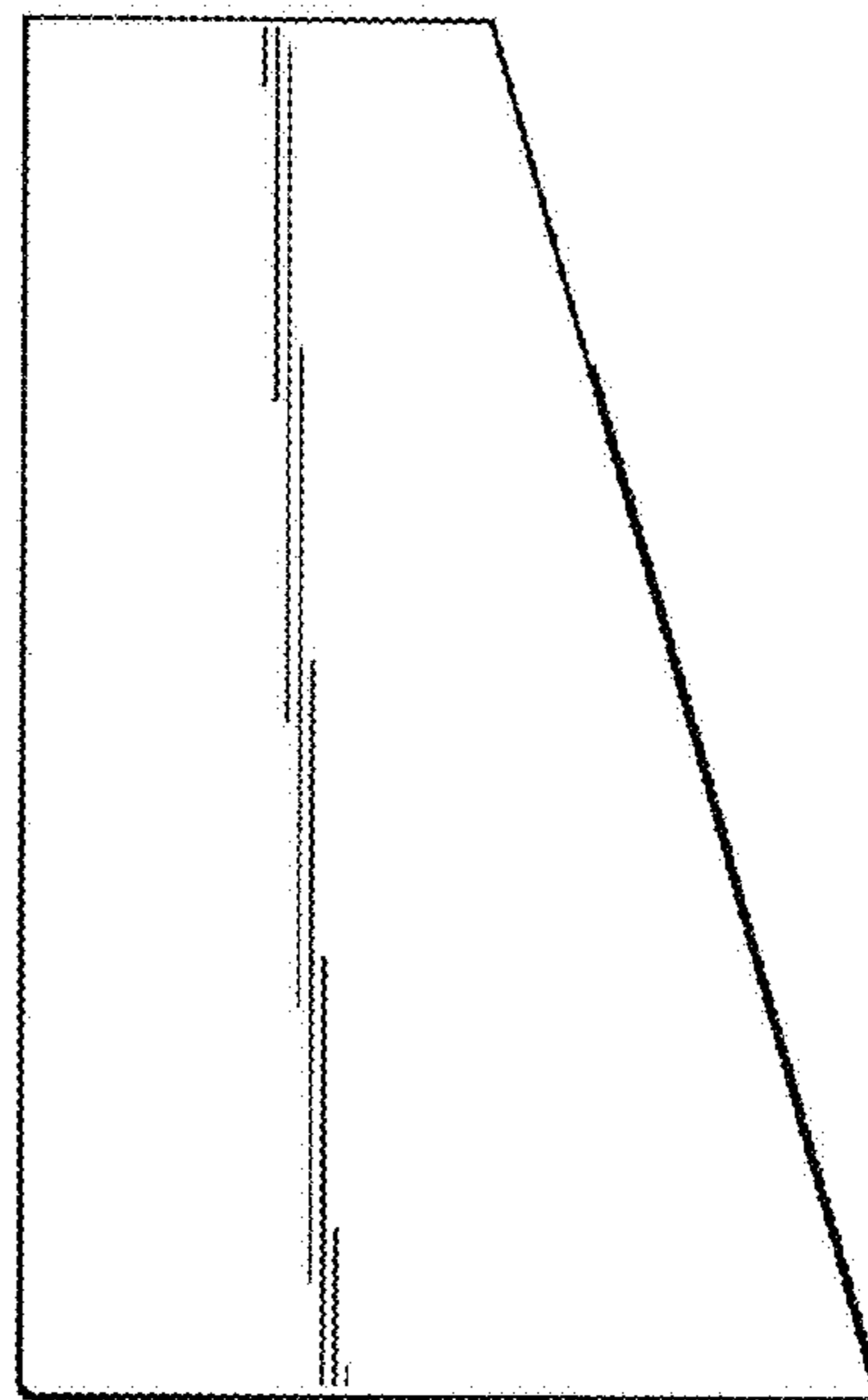

Fig.5.

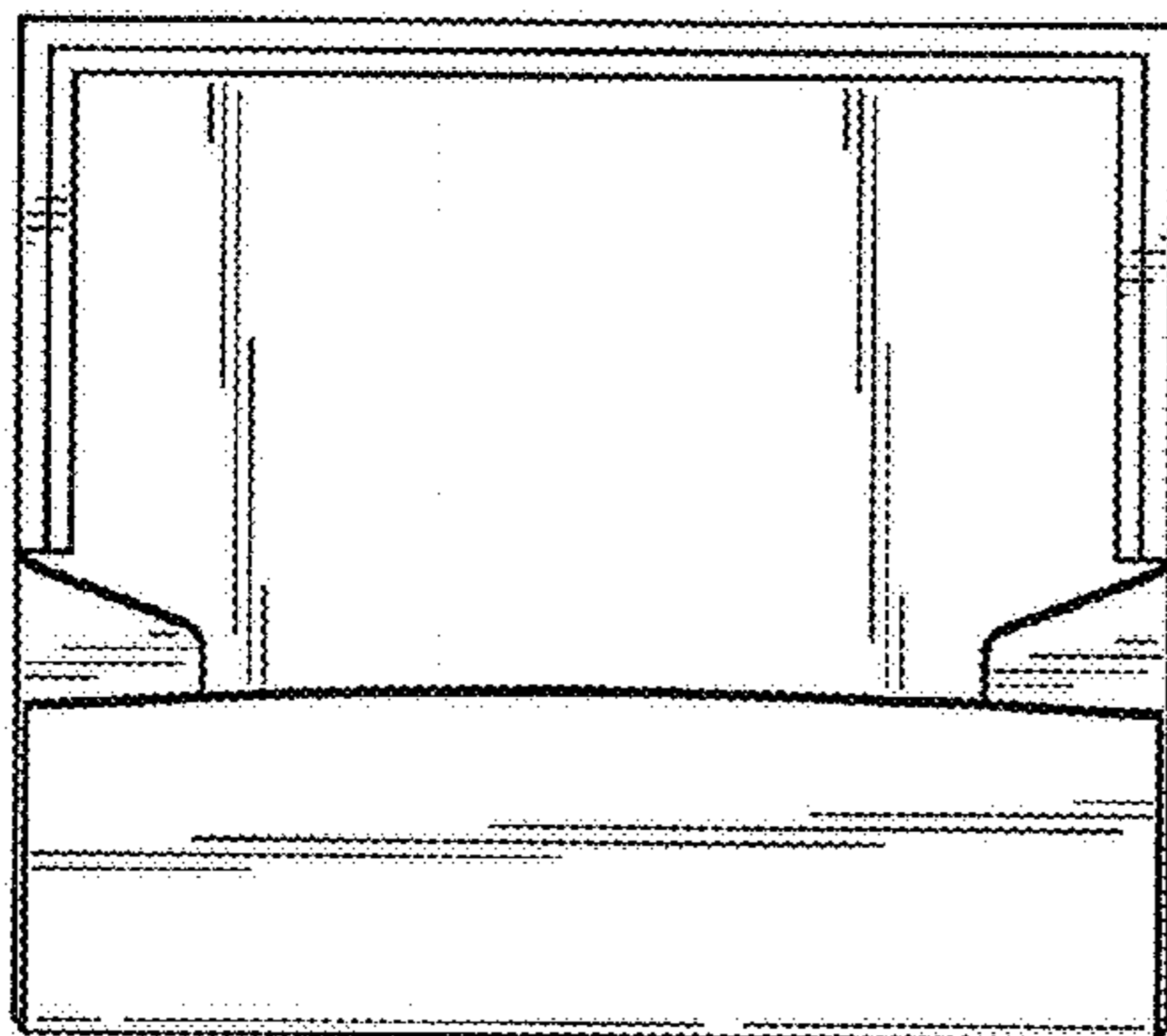

Fig.6.

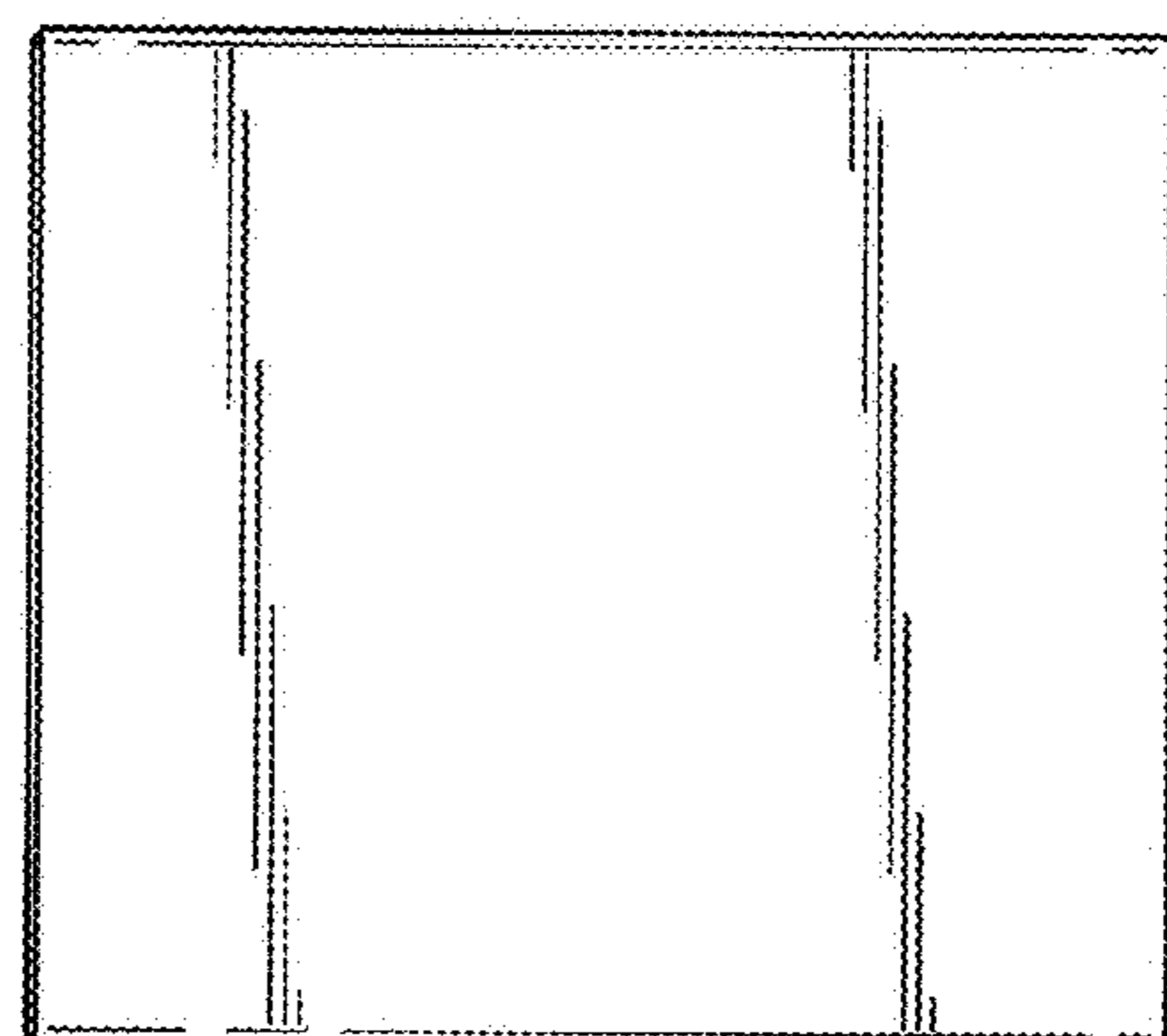

Fig.7.