



US00D617057S

(12) **United States Design Patent**
Terwilleger

(10) **Patent No.:** **US D617,057 S**
(45) **Date of Patent:** **** Jun. 1, 2010**

(54) **ANIMAL FEEDING NIPPLE**
(75) Inventor: **Arthur Raymond Terwilleger**,
Plattsburg, MO (US)
(73) Assignee: **West Agro Inc.**, Kansas City, MO (US)
(**) Term: **14 Years**
(21) Appl. No.: **29/332,308**
(22) Filed: **Feb. 12, 2009**
(51) **LOC (9) Cl.** **30-07**
(52) **U.S. Cl.** **D30/121; D30/199**
(58) **Field of Classification Search** D30/121,
D30/132, 133, 199; 119/51.01, 51.5, 51.13,
119/71, 72, 75, 78-80, 72.5, 73, 477, 515,
119/454, 475, 521, 464, 14.47, 14.52; D24/115-117,
D24/193-199, 215, 141; D21/405-408,
D21/604; 606/234-236; 215/11.1-11.6,
215/6, 12.1, 13.1, 216, 255, 256, 321, 349,
215/378, 387, 398, 400, 902, DIG. 8; D3/22,
D3/202, 215, 226, 229, 230; D9/452, 454,
D9/500-504, 520, 526, 529, 530, 538, 539,
D9/542, 543, 552, 553, 563, 571, 724; D7/511,
D7/533, 607, 619.1, 624.2, 624.3, 393, 394,
D7/436, 456, 526; 446/73, 81, 175; 248/102-107,
248/363; 294/64.1, 106; 220/739.902, 903,
220/DIG. 27; 222/153.14, 158, 209, 213,
222/420, 455, 457, 562, 563, 207; 604/295;
137/614.18; 251/339

See application file for complete search history.

(56) **References Cited**

U.S. PATENT DOCUMENTS

RE11,086 E * 6/1890 Eggers 215/11.5
586,011 A * 7/1897 Butz 215/11.1
605,161 A * 6/1898 Clement et al. 215/11.1
643,287 A * 2/1900 Hall, Jr. 119/71
805,641 A 11/1905 Gallagher
966,645 A * 8/1910 Berry et al. 119/71
1,074,313 A * 9/1913 Davis 119/71
1,146,639 A 7/1915 Miller

1,510,571 A 10/1924 Ware
1,662,171 A * 3/1928 Savery 232/43.2
1,902,433 A 3/1933 Brown
2,073,737 A * 3/1937 Ellison 119/14.49
2,119,691 A * 6/1938 Vanderbilt 119/71
2,143,719 A * 1/1939 Schulte 215/11.1
D130,791 S * 12/1941 Porthouse et al. D24/196
D143,774 S * 2/1946 Wagner D24/196
2,506,205 A * 5/1950 Fry 119/71
2,513,896 A 7/1950 Searer
2,522,757 A * 9/1950 Larson 119/71
D160,940 S * 11/1950 Griesinger D24/196
2,533,643 A * 12/1950 Verner 119/71
2,575,056 A * 11/1951 Jones 248/103
2,583,041 A * 1/1952 Coyner 119/71
2,616,581 A 11/1952 Madsen, et al.
2,622,559 A * 12/1952 Luth 119/14.47
2,628,591 A * 2/1953 Coyner 119/71
2,669,966 A * 2/1954 Skett 119/14.49
2,672,124 A * 3/1954 McCrary 119/71
2,688,326 A 9/1954 Lerman, et al.

(Continued)

Primary Examiner—Susan Moon Lee
(74) *Attorney, Agent, or Firm*—Lathrop & Gage LLP

(57) **CLAIM**

The ornamental design for an animal feeding nipple, as shown and described.

DESCRIPTION

FIG. 1 is a right perspective view of an animal feeding nipple showing our new design;
FIG. 2 is a top plan view thereof;
FIG. 3 is a front view thereof;
FIG. 4 is a back view thereof;
FIG. 5 is a bottom view thereof;
FIG. 6 is a right side view thereof; and,
FIG. 7 is a left side view thereof.

1 Claim, 4 Drawing Sheets

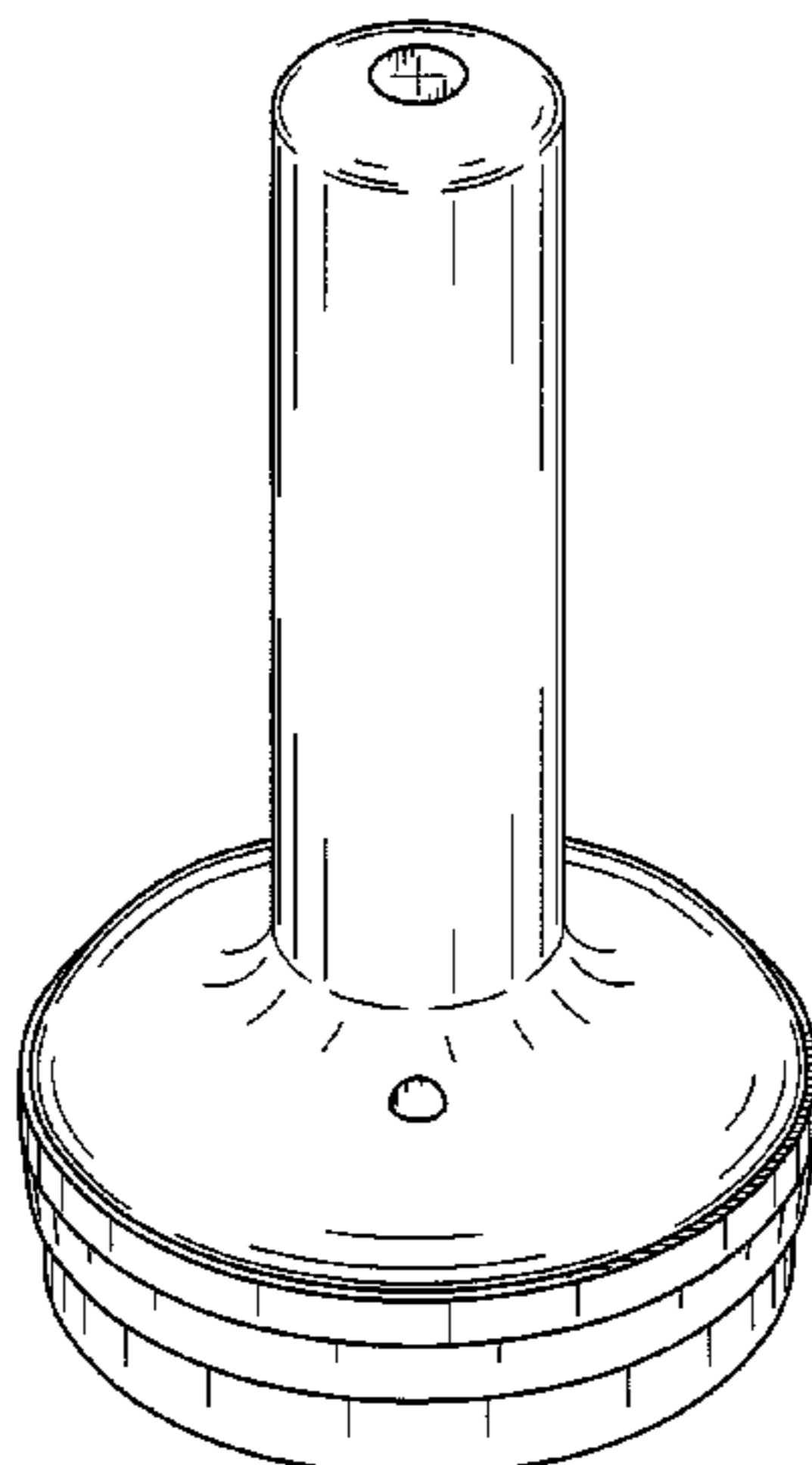

US D617,057 S

Page 2

U.S. PATENT DOCUMENTS

2,695,007	A *	11/1954	Meltzer	119/71	D359,808	S *	6/1995	Raghava	D24/196
2,697,414	A *	12/1954	Coyner	119/71	5,474,028	A	12/1995	Larson et al.	
2,699,778	A	1/1955	Ezell		5,598,809	A *	2/1997	McInnes	119/71
2,710,593	A *	6/1955	Lippi	119/71	D382,059	S *	8/1997	Maya et al.	D24/196
2,714,368	A *	8/1955	Voigt et al.	119/71	D389,600	S *	1/1998	Luedecke	D27/118
2,773,475	A *	12/1956	Zottoli	119/71	D392,776	S *	3/1998	Trossevin et al.	D30/121
2,800,107	A *	7/1957	Niggeler	119/71	5,769,285	A	6/1998	Upham et al.	
2,942,746	A *	6/1960	Porthouse et al.	215/11.1	5,784,999	A	7/1998	Larson et al.	
2,986,117	A *	5/1961	Ronaldson	119/14.38	5,788,097	A *	8/1998	McInnes	215/11.1
3,042,002	A *	7/1962	Liell	119/71	5,797,505	A	8/1998	Kaura	
3,075,666	A *	1/1963	Hoffstein	215/11.3	D399,006	S *	9/1998	Jenkins	D24/197
3,077,279	A *	2/1963	Mitchell	215/11.1	D412,582	S *	8/1999	Morano	D24/197
3,158,136	A *	11/1964	George	119/14.52	6,003,698	A	12/1999	Morano	
3,203,569	A *	8/1965	Shomock et al.	215/11.1	D421,306	S *	2/2000	Meyers et al.	D24/197
D215,253	S *	9/1969	Baxton et al.	D24/196	D426,639	S *	6/2000	McGrath-Ferraioli	D24/197
3,468,445	A *	9/1969	Balin	215/11.6	D441,086	S *	4/2001	Morano	D24/197
3,593,870	A	7/1971	Anderson		6,454,122	B1 *	9/2002	Luedecke	220/576
3,648,662	A *	3/1972	Lines	119/71	6,616,000	B1	9/2003	Renz	
D223,972	S *	6/1972	Ritsi	D24/196	6,626,322	B1 *	9/2003	Carter et al.	220/576
3,750,628	A *	8/1973	Schumacher	119/72.5	6,645,228	B2	11/2003	Renz	
3,967,587	A *	7/1976	Noorlander	119/14.49	6,884,229	B2	4/2005	Renz	
3,995,596	A *	12/1976	Andersson	119/71	D504,725	S *	5/2005	Randolph et al.	D24/196
D248,329	S *	6/1978	Gensini	D27/123	6,941,893	B2 *	9/2005	Gabriel et al.	119/72.5
D264,380	S *	5/1982	Chrones	D24/196	7,004,339	B2	2/2006	Renz	
4,393,813	A *	7/1983	Sou	119/72.5	7,032,766	B2 *	4/2006	Luedecke et al.	220/576
D271,797	S *	12/1983	Chrones	D24/196	7,036,975	B2	5/2006	Renz	
D275,231	S *	8/1984	Fuller	D24/197	7,121,229	B2 *	10/2006	Hong	119/421
4,502,603	A *	3/1985	Hsu	215/11.6	7,122,045	B2	10/2006	Randolph et al.	
4,610,220	A *	9/1986	Goldberg et al.	119/14.47	7,185,775	B1	3/2007	Decal	
4,633,814	A *	1/1987	Eastman et al.	119/71	D547,874	S *	7/2007	Horie et al.	D24/194
D294,735	S *	3/1988	Morano et al.	D24/196	7,326,234	B2	2/2008	Lieberman	
4,803,955	A *	2/1989	Gonsalves	119/71	7,337,746	B2 *	3/2008	Clark et al.	119/71
D306,346	S *	2/1990	Saras	D24/141	7,540,388	B2 *	6/2009	Silver	215/11.1
4,993,365	A *	2/1991	Weerstra	119/71	2005/0109355	A1 *	5/2005	Goldberg et al.	131/231
4,993,568	A	2/1991	Morifuji et al.		2006/0201435	A1 *	9/2006	Arnerup et al.	119/71
5,069,161	A *	12/1991	Pera	119/14.47	2007/0012254	A1 *	1/2007	Clark et al.	119/71
5,101,991	A	4/1992	Morifuji et al.		2007/0102388	A1	5/2007	Lewis et al.	
5,129,532	A *	7/1992	Martin	215/11.1	2007/0131637	A1	6/2007	Tamera et al.	
D339,197	S *	9/1993	Ziegler	D24/196	2007/0277737	A1 *	12/2007	Maier et al.	119/14.45
5,279,253	A *	1/1994	Lubberink	119/14.08	2008/0128379	A1 *	6/2008	Hen	215/11.5
RE34,725	E *	9/1994	Braden	119/515	2009/0314737	A1 *	12/2009	Pfenniger	215/11.5

* cited by examiner

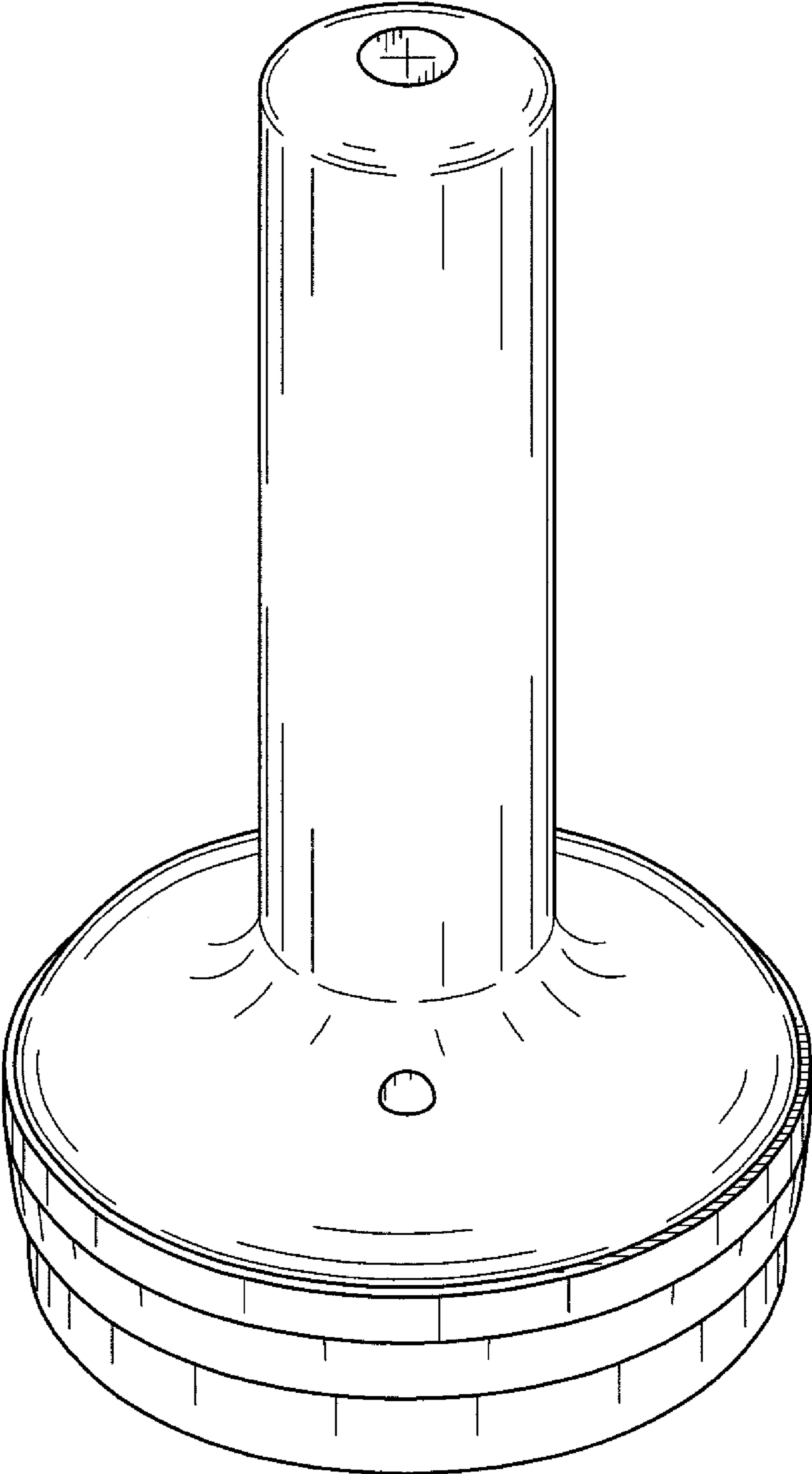

FIG. 1

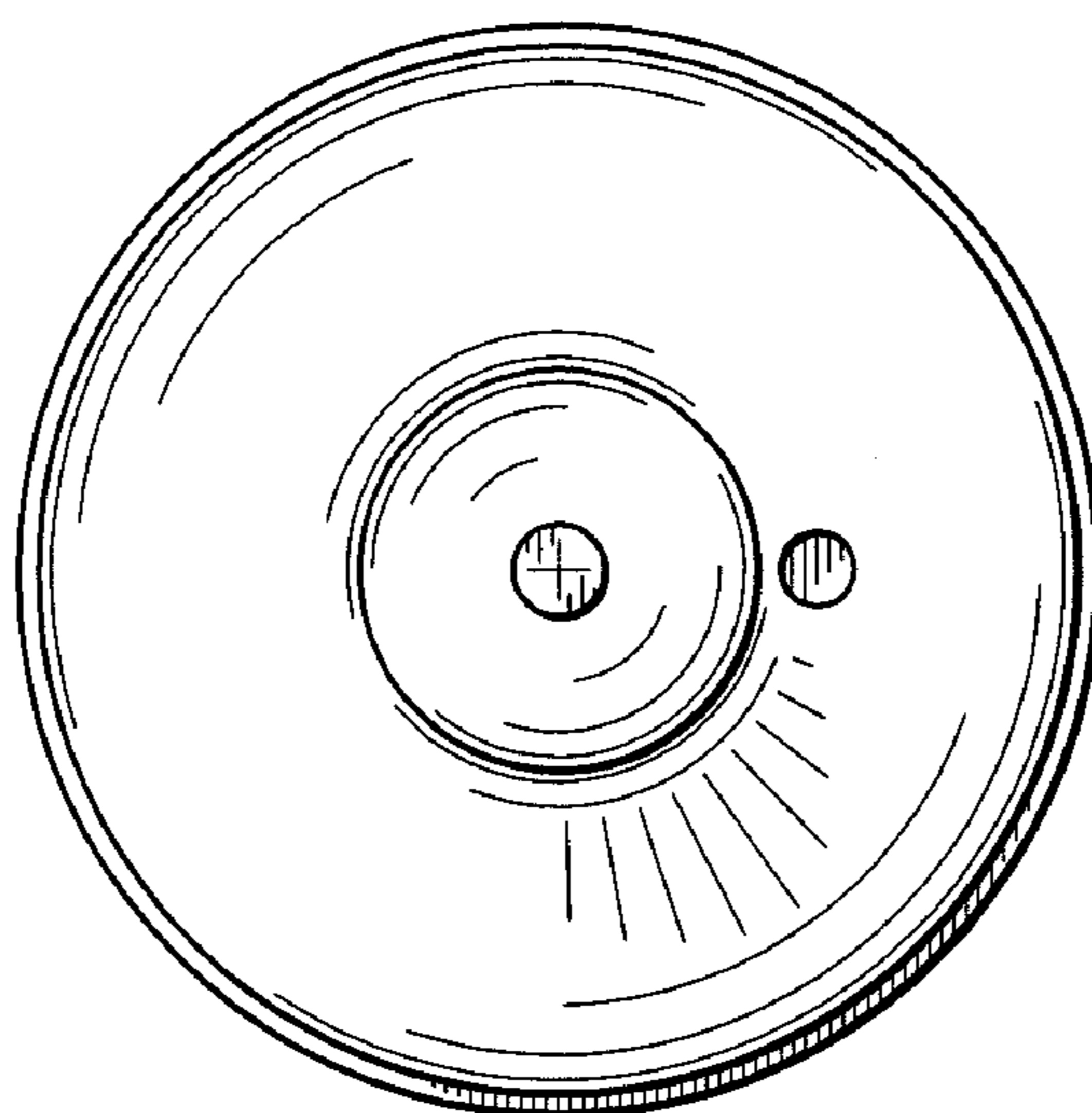

FIG. 2

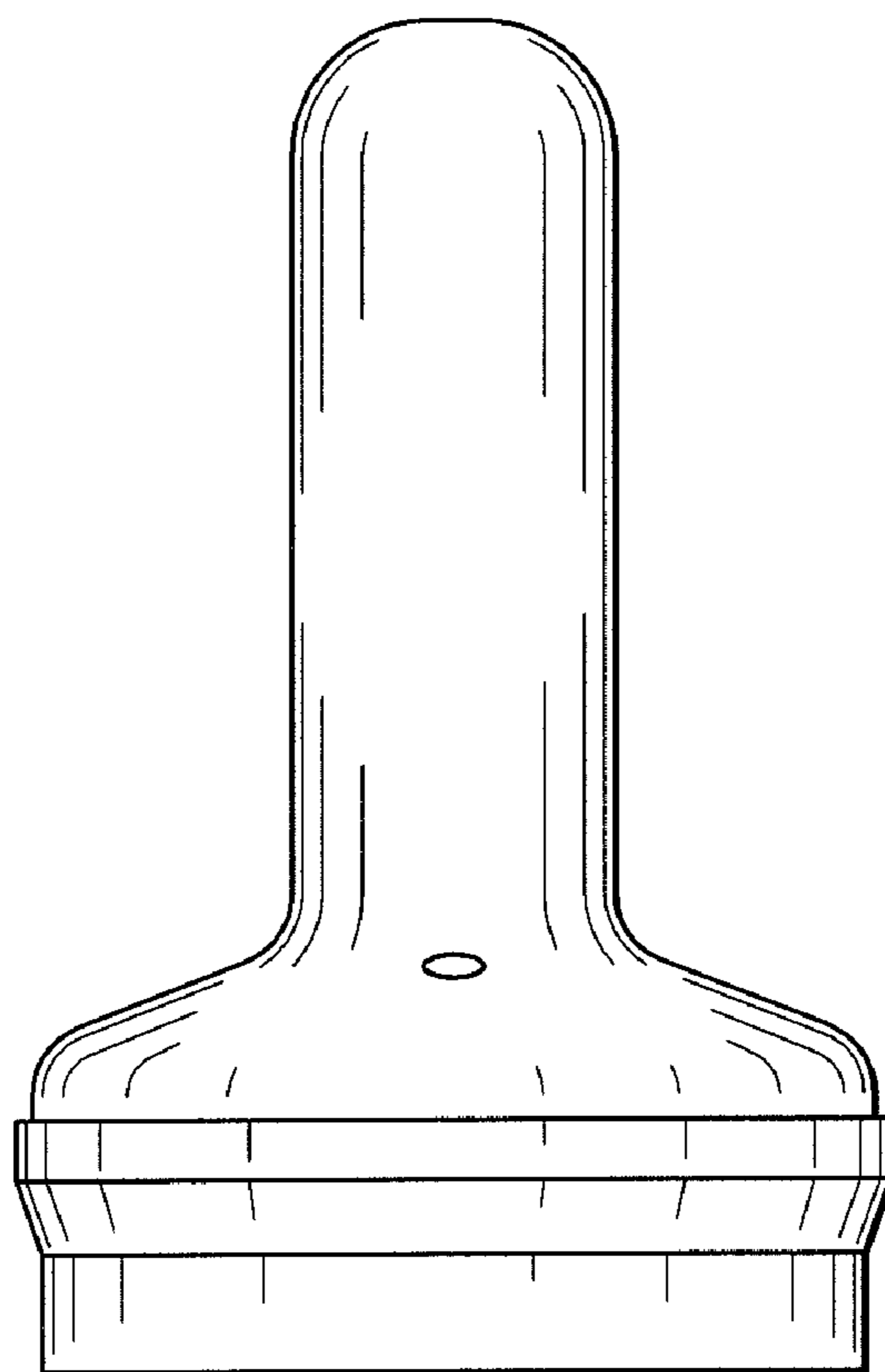

FIG. 3

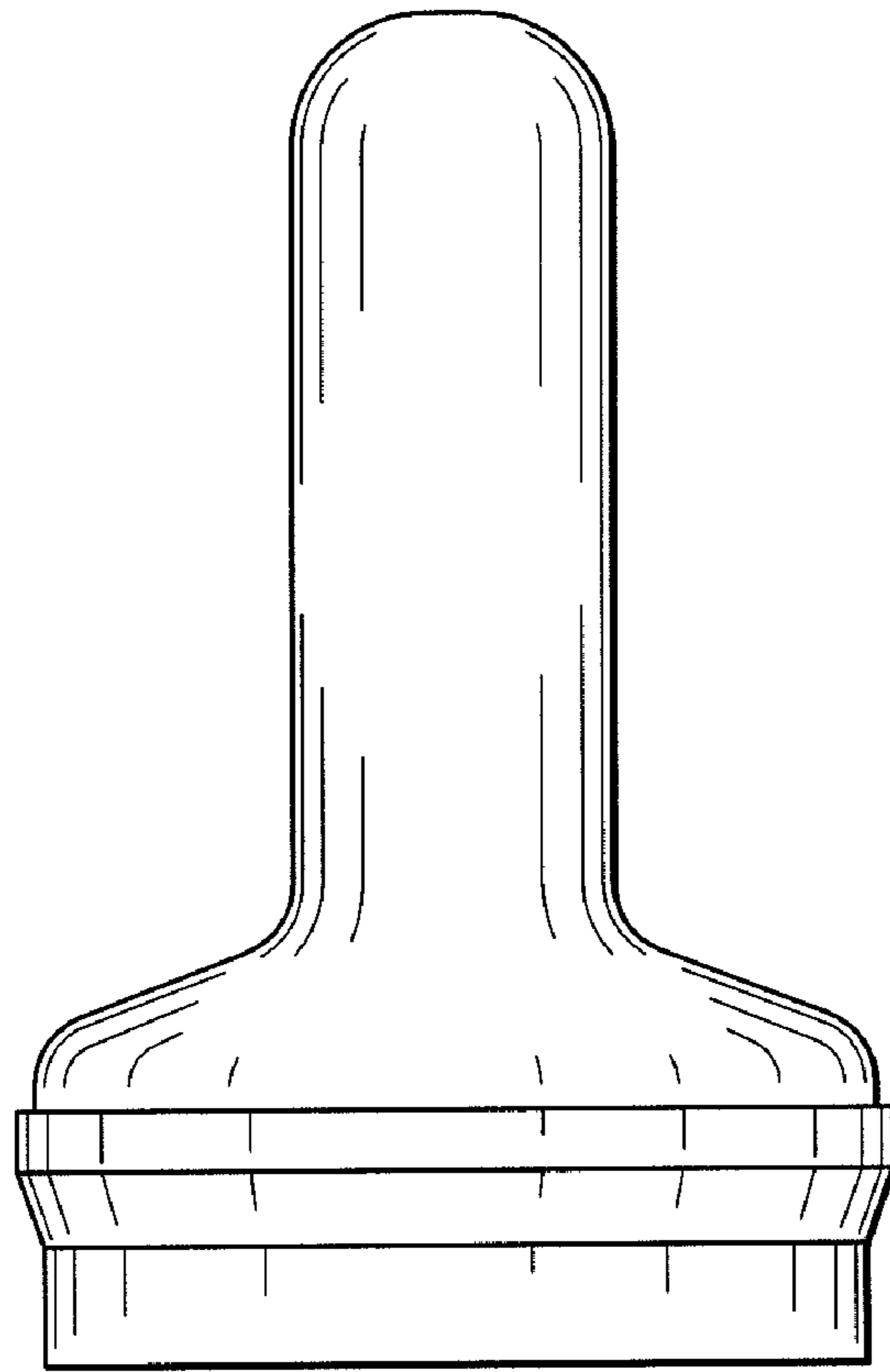

FIG. 4

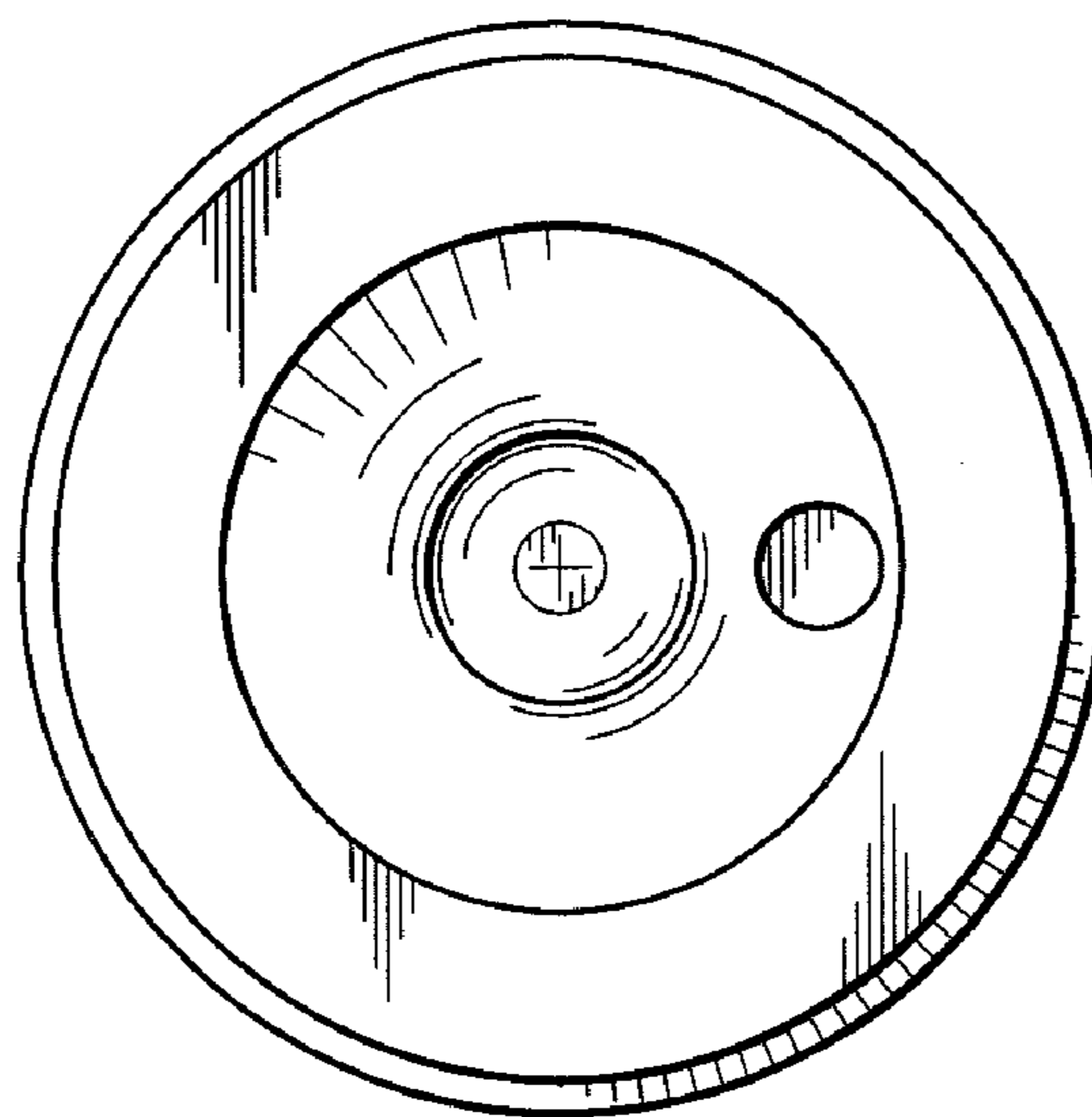

FIG. 5

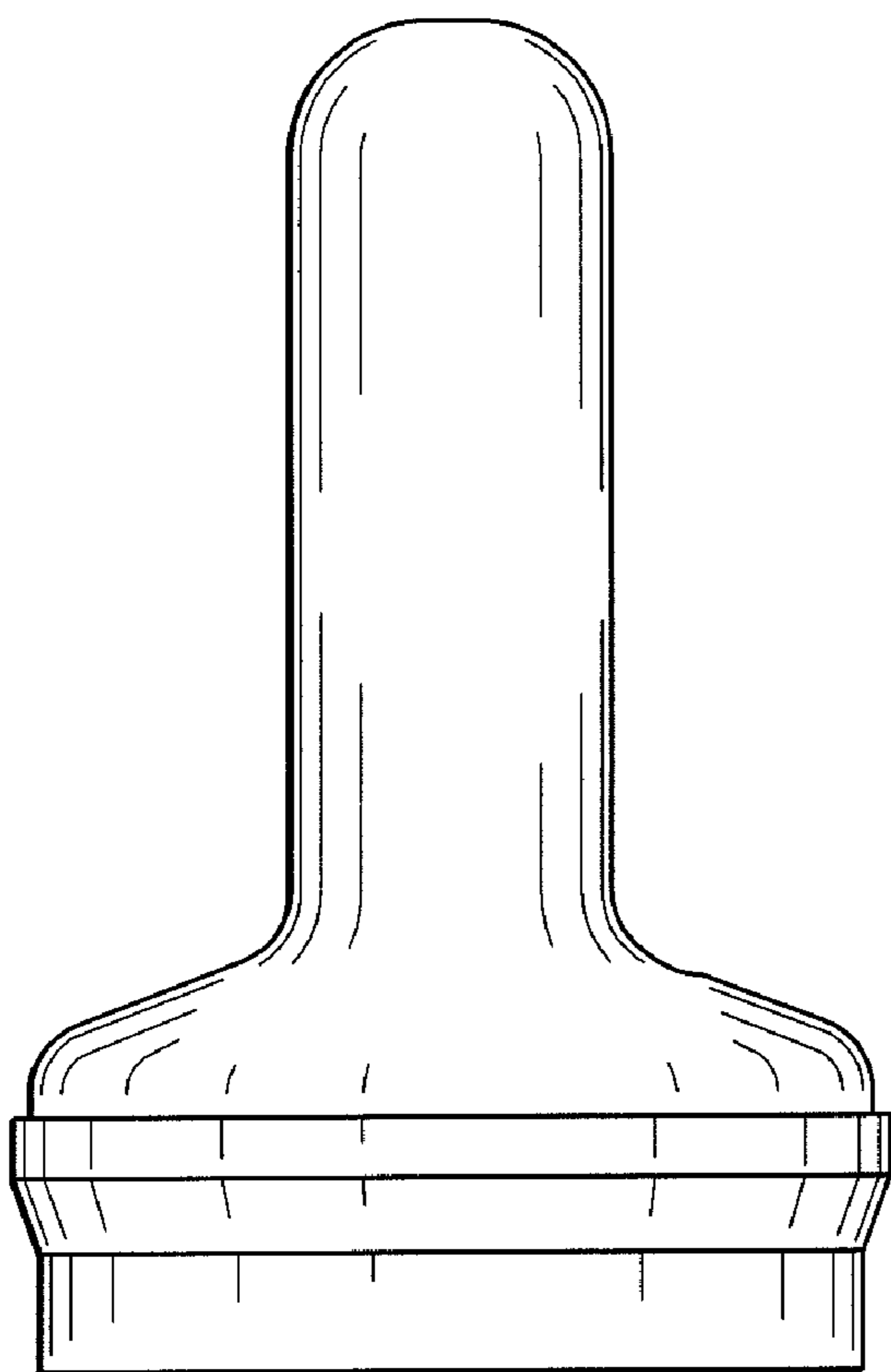

FIG. 6

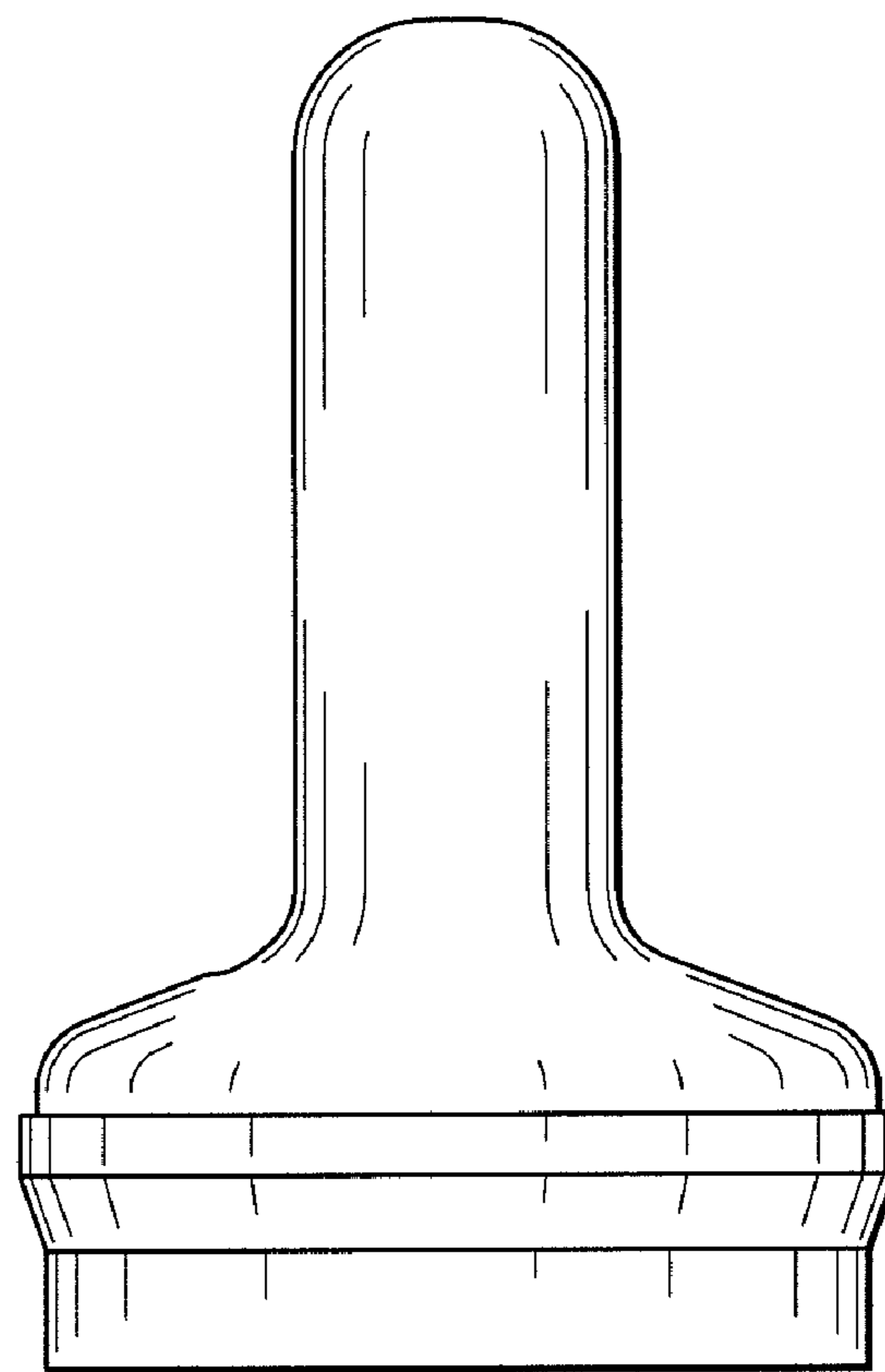

FIG. 7