



US00D617045S

(12) **United States Design Patent**
Uehara et al.

(10) **Patent No.:** **US D617,045 S**
(45) **Date of Patent:** **** Jun. 1, 2010**

(54) **APPLICATOR FOR LIP COSMETICS**

2007/0181143 A1* 8/2007 Montoli 132/320

(75) Inventors: **Kazuyuki Uehara**, Sumida ku (JP); **Yu Saito**, Sumida ku (JP); **Kenko Kurita**, Sumida ku (JP)

FOREIGN PATENT DOCUMENTS

JP	D1238065	5/2005
JP	D1265528	3/2006
JP	2008-012177	1/2008
TW	D123472	7/2008
TW	D123473	7/2008

(73) Assignee: **Kao Corporation**, Tokyo (JP)

(**) Term: **14 Years**

* cited by examiner

(21) Appl. No.: **29/330,668**

Primary Examiner—Janice E Seeger

Assistant Examiner—Zenia I Bennett

(22) Filed: **Jan. 12, 2009**

(74) *Attorney, Agent, or Firm*—Oblon, Spivak, McClelland, Maier & Neustadt, L.L.P.

(30) **Foreign Application Priority Data**

Dec. 29, 2008 (JP) 2008-033381

(57) **CLAIM**

(51) **LOC (9) Cl.** **28-02**

The ornamental design for an applicator for lip cosmetics, as shown and described.

(52) **U.S. Cl.** **D28/7**

(58) **Field of Classification Search** D28/7,
D28/8, 20–22, 30–31, 76, 85, 99; 132/108,
132/202, 208, 317, 320; 401/202–207, 261–267;
D4/132–135

DESCRIPTION

FIG. 1 is a top, front, and right side perspective view of a applicator for lip cosmetics;

See application file for complete search history.

FIG. 2 is a front elevational view thereof;

FIG. 3 is a rear elevational view thereof;

(56) **References Cited**

U.S. PATENT DOCUMENTS

D197,107 S *	12/1963	Forgue	D28/7
D270,768 S	9/1983	Cassai et al.		
D272,100 S	1/1984	Cassai et al.		
D406,921 S *	3/1999	Roeder	D28/7
D421,302 S *	2/2000	Korteweg	D24/119
D432,721 S *	10/2000	Lerolle	D28/76
D436,449 S *	1/2001	Baltierra	D4/135
D496,756 S *	9/2004	McGhee	D28/57
D527,143 S *	8/2006	Fischer	D28/7
D537,564 S *	2/2007	Montoli	D28/7
D539,982 S *	4/2007	Nobuto et al.	D28/76
D541,979 S *	5/2007	Montoli	D28/7
D544,644 S *	6/2007	Hartstock et al.	D28/7
D586,048 S *	2/2009	Hartstock et al.	D28/76
2004/0018037 A1	1/2004	Gueret		

FIG. 4 is a left side elevational view thereof;

FIG. 5 is a right side elevational view thereof;

FIG. 6 is a top plan view thereof

FIG. 7 is a bottom plan view thereof;

FIG. 8 is an enlarged view of FIG. 2;

FIG. 9 is a cross-sectional view taken along line 9—9 from FIG. 8;

FIG. 10 is a cross-sectional view taken along line 10—10 from FIG. 8; and,

FIG. 11 is a cross-sectional view taken along line 11—11 from FIG. 9.

The broken lines in the drawings depict environmental subject matter only and form no part of the claimed design.

1 Claim, 5 Drawing Sheets

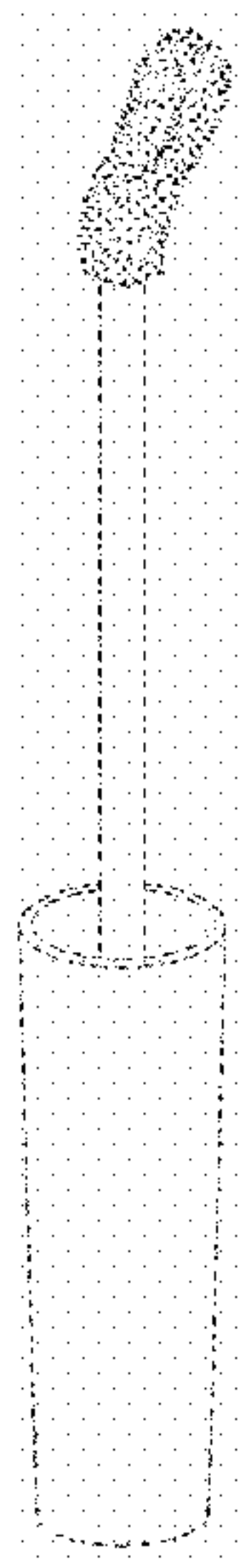

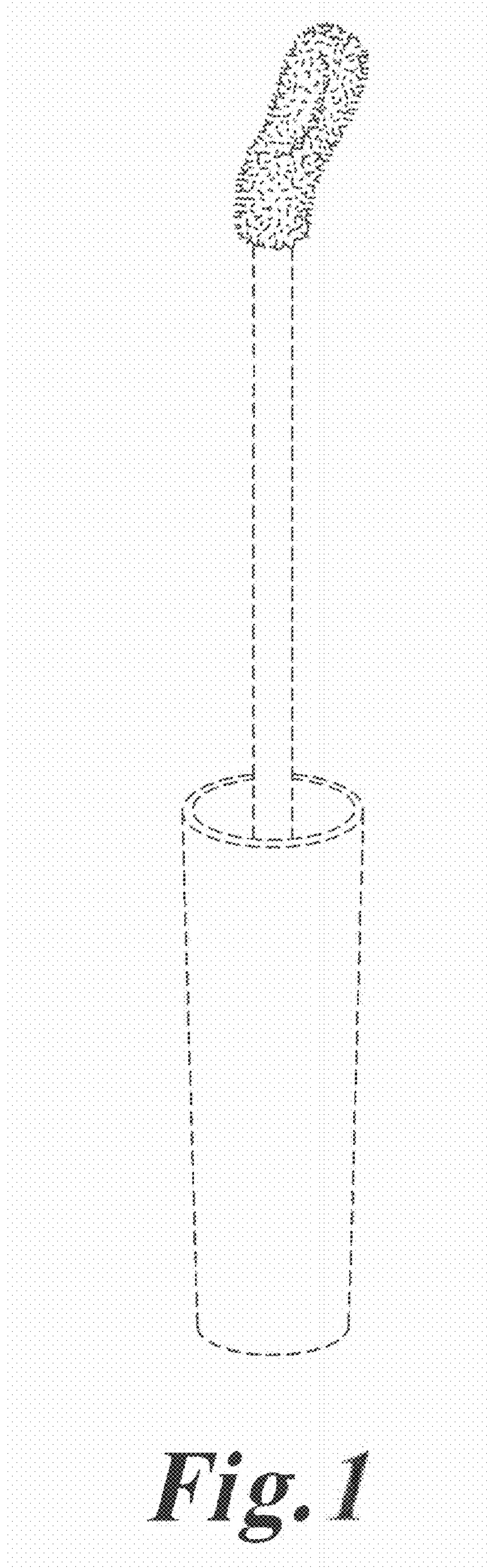

Fig. 1

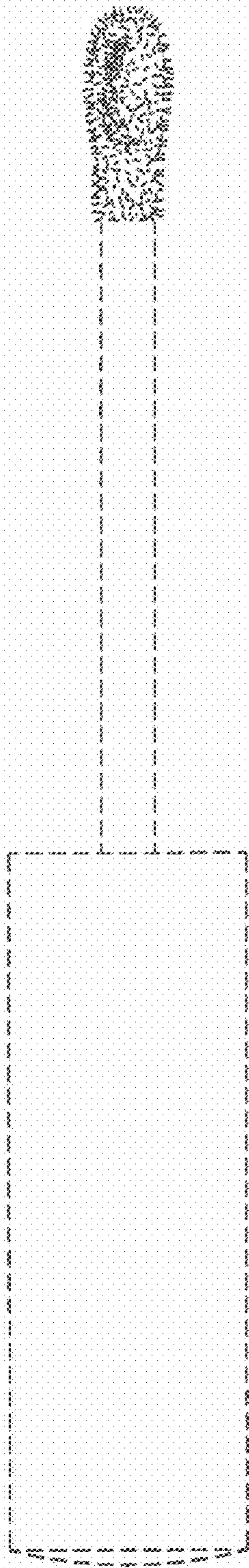

Fig. 2

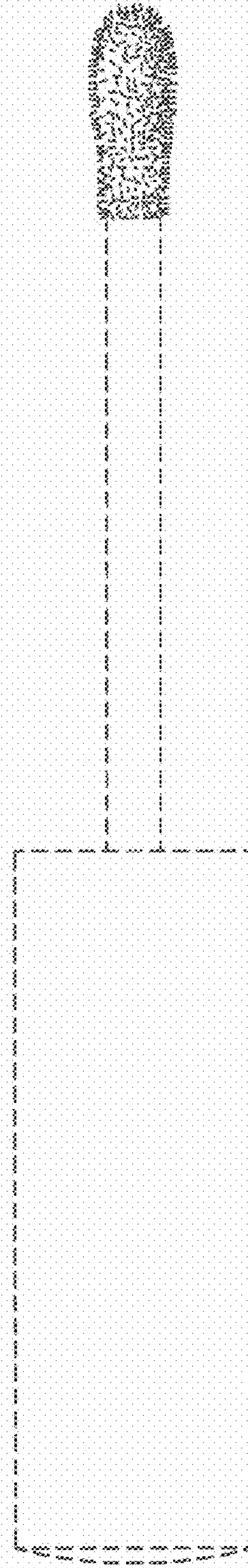

Fig. 3

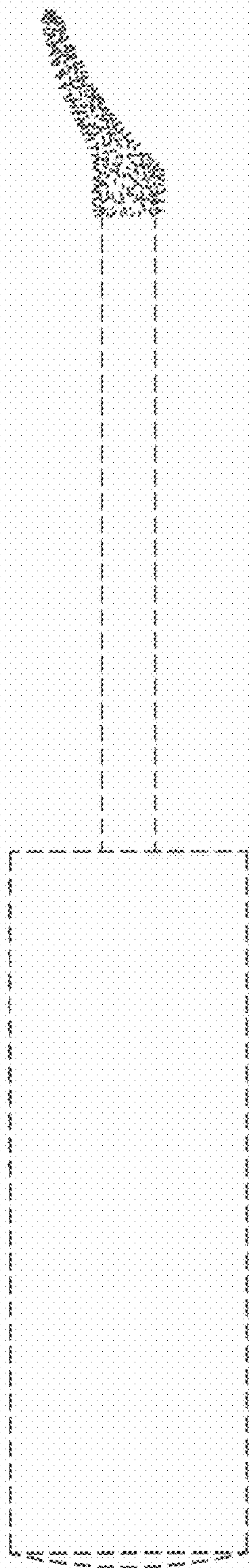

Fig. 4

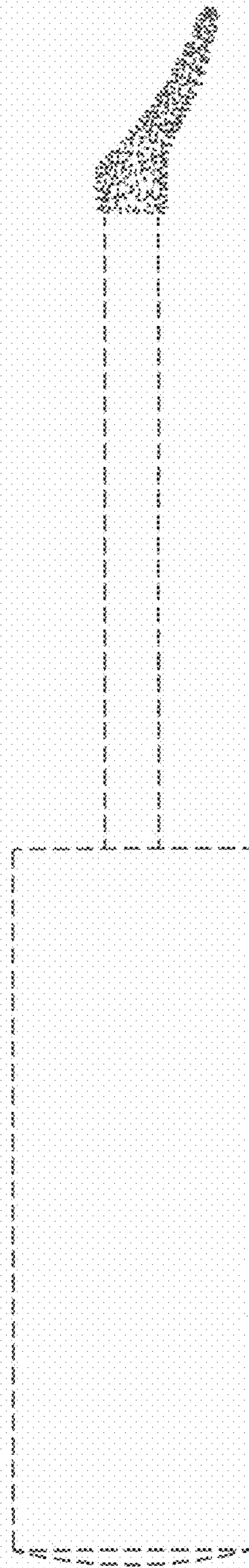

Fig. 5

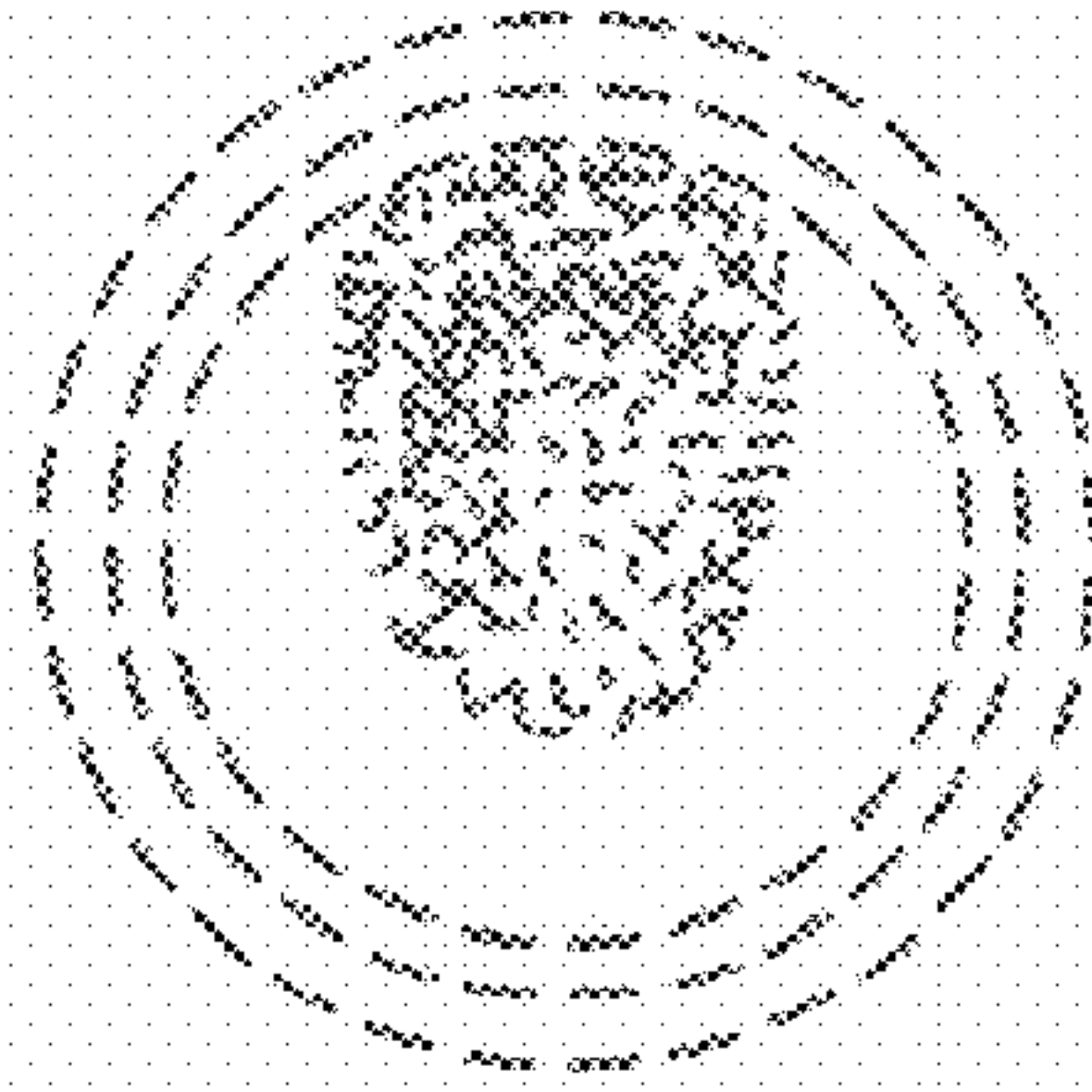

Fig. 6

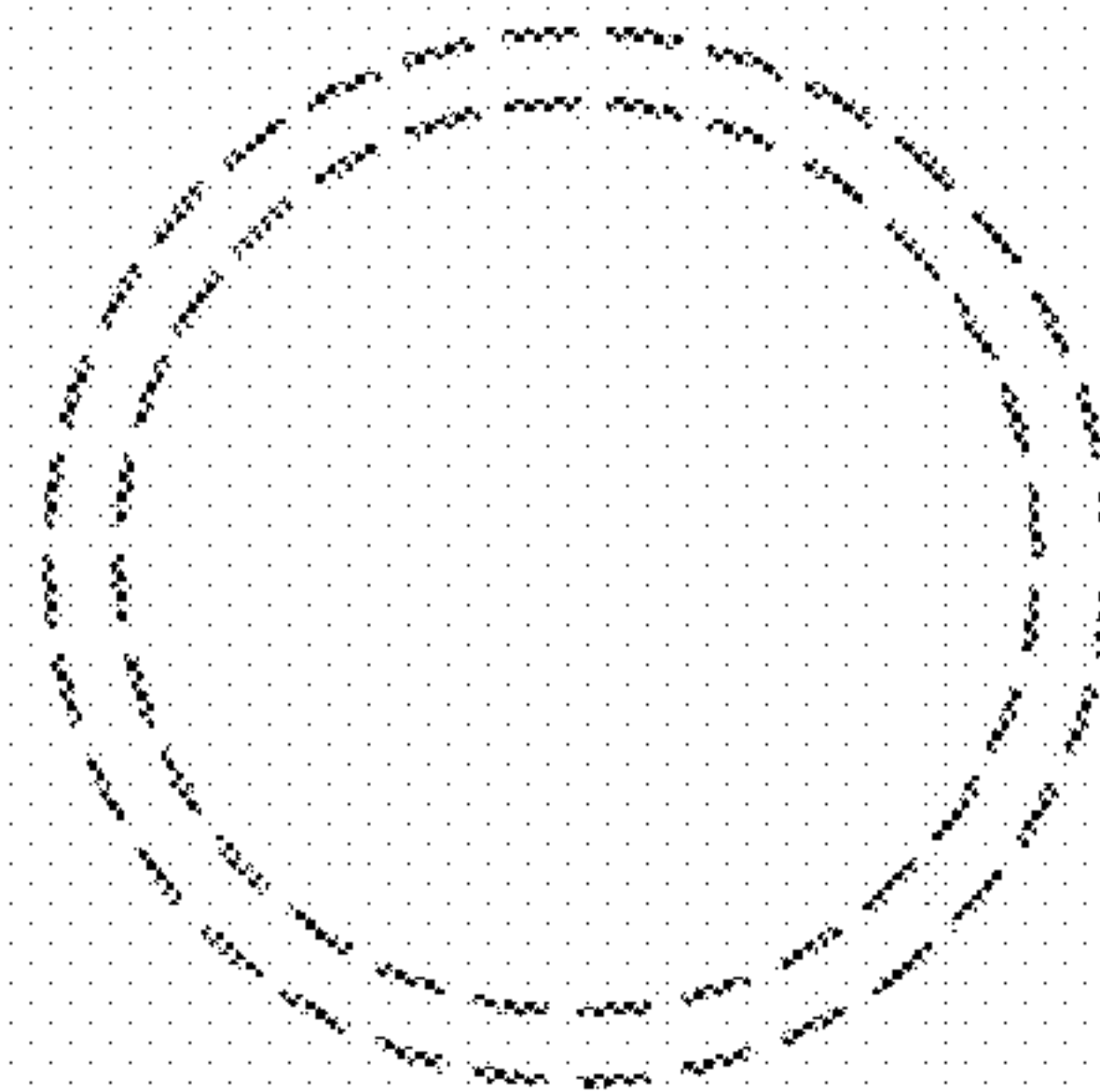

Fig. 7

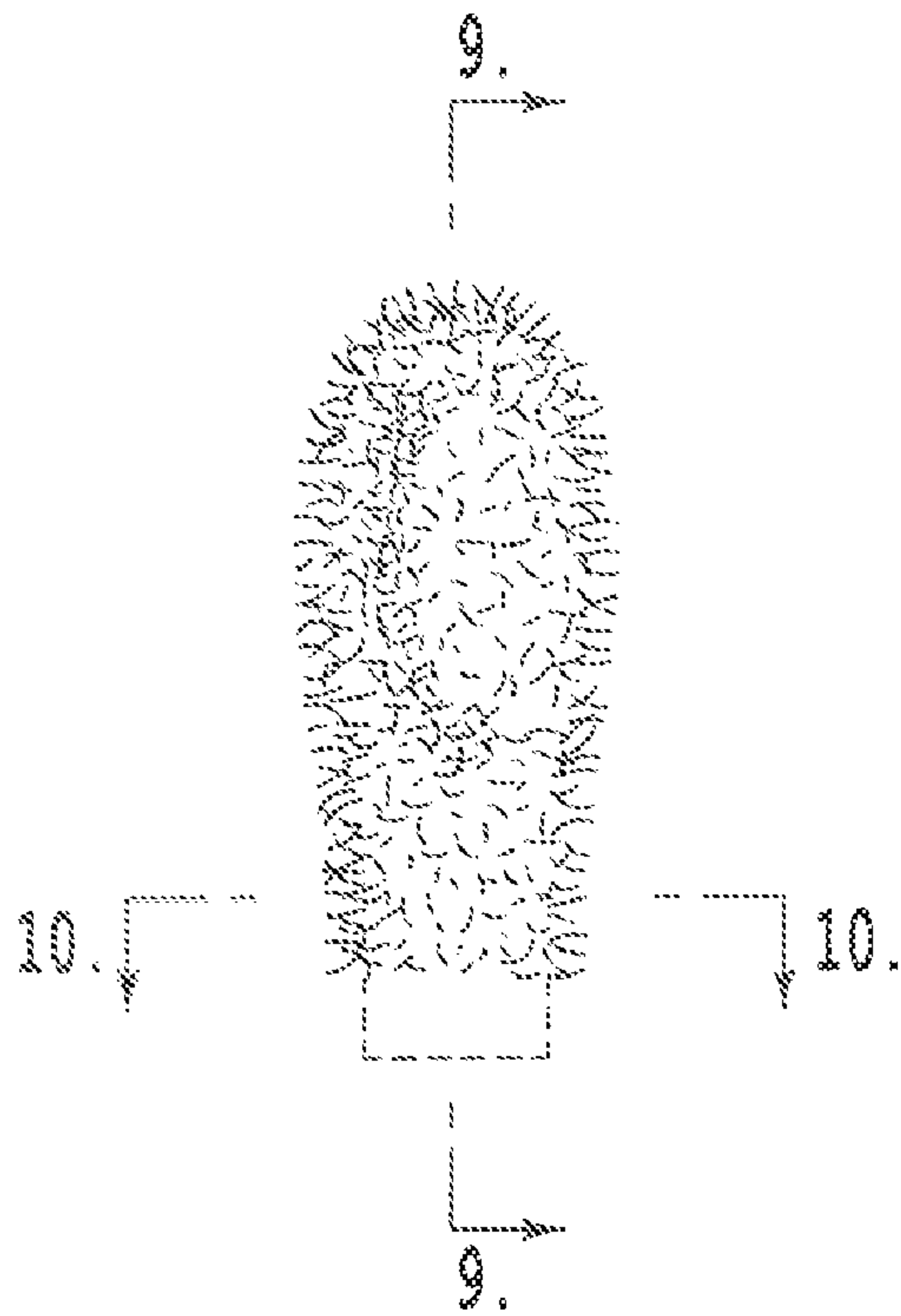

Fig. 8

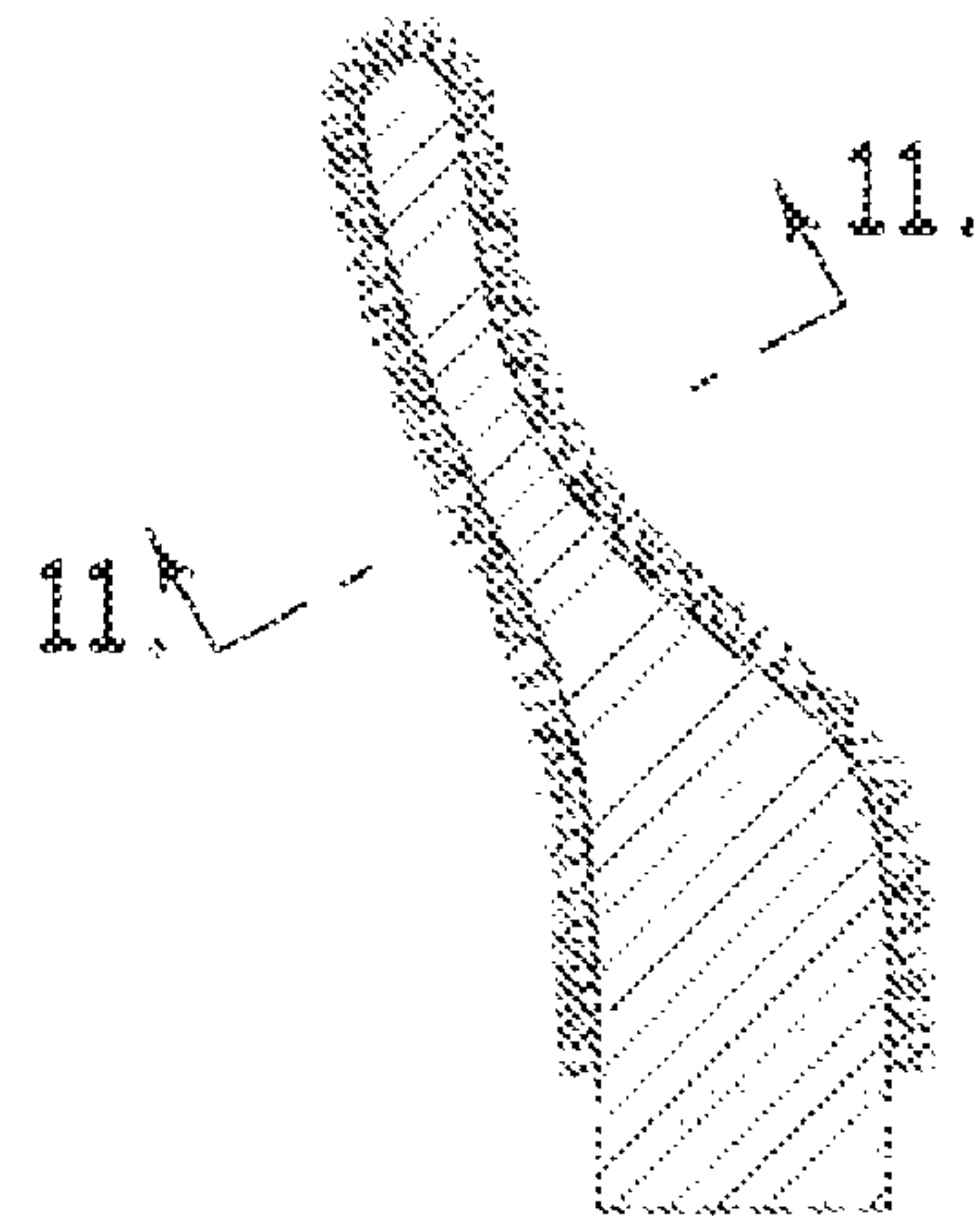

Fig. 9

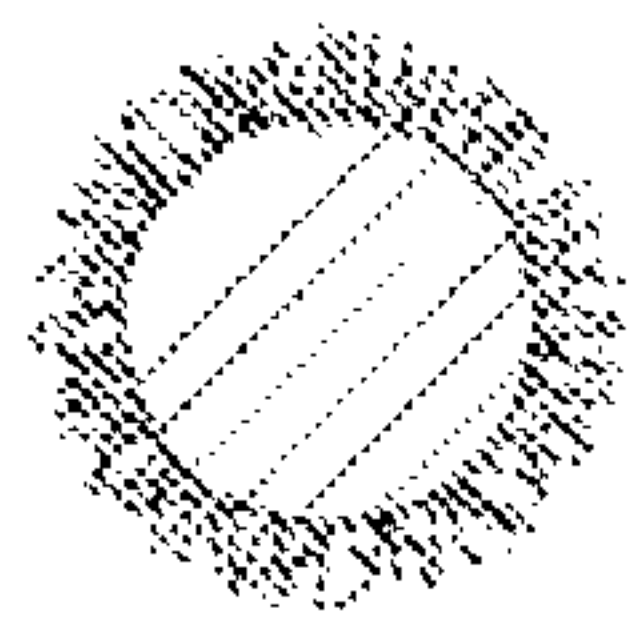

Fig. 10



Fig. 11