



US00D617028S

(12) **United States Design Patent**
Verfuерth et al.

(10) **Patent No.:** **US D617,028 S**
(45) **Date of Patent:** **** Jun. 1, 2010**

(54) **LIGHTING FIXTURE**

(75) Inventors: **Neal R. Verfuерth**, Plymouth, WI (US);
Kenneth J. Wetenkamp, Plymouth, WI
(US); **Anthony J. Bartol**, Plymouth, WI
(US); **Ronald E. Ernst**, Waldo, WI (US)

(73) Assignee: **Orion Energy Systems, Inc.**,
Manitowoc, WI (US)

(**) Term: **14 Years**

(21) Appl. No.: **29/346,569**

(22) Filed: **Nov. 2, 2009**

Related U.S. Application Data

(62) Division of application No. 29/343,007, filed on Sep.
4, 2009, now Pat. No. Des. 606,697.

(51) **LOC (9) Cl.** **26-05**

(52) **U.S. Cl.** **D26/75**

(58) **Field of Classification Search** D26/24,
D26/67-68, 71-72, 74-76, 80, 85, 89; 362/138,
362/147-148, 150, 183, 217-225, 362, 364,
362/368, 374

See application file for complete search history.

(56) **References Cited**

U.S. PATENT DOCUMENTS

D125,468 S	2/1941	Dreyfuss	
D208,491 S	9/1967	Brooks	
D209,982 S	1/1968	Cohen	
D260,187 S *	8/1981	Andersson	D26/85
D268,367 S *	3/1983	Paquette et al.	D26/76
D329,715 S *	9/1992	Dieperink	D26/76
D330,268 S *	10/1992	Jaksich	D26/74
5,172,976 A *	12/1992	Bogdanovs	362/374
5,649,759 A	7/1997	Korte	
D391,659 S *	3/1998	Gaskins et al.	D26/71
D411,324 S	6/1999	Roorda	
D411,326 S	6/1999	Roorda	
D424,732 S *	5/2000	Cece	D26/76
D427,340 S	6/2000	Beghelli	

D441,479 S	5/2001	McCormick et al.	
D452,340 S	12/2001	Pickett et al.	
D457,981 S *	5/2002	Yeh	D26/76

(Continued)

Primary Examiner—Philip S Hyder
Assistant Examiner—Susan E Krakower
(74) *Attorney, Agent, or Firm*—Foley & Lardner LLP

(57) **CLAIM**

We claim the ornamental design for a lighting fixture, as shown and described.

DESCRIPTION

FIG. 1 is a bottom perspective view of the claimed design;
FIG. 2 is a top perspective view of the claimed design shown
in FIG. 1;

FIG. 3 is a first side view of the claimed design shown in FIG.
1;

FIG. 4 is a second side view of the claimed design shown in
FIG. 1;

FIG. 5 is a top view of the claimed design shown in FIG. 1;

FIG. 6 is a bottom view of the claimed design shown in FIG.
1;

FIG. 7 is a front view of the claimed design shown in FIG. 1;
and,

FIG. 8 is a rear view of the claimed design shown in FIG. 1.

The ornamental design which is claimed is shown in solid
lines in the figures. The broken lines in the figures illustrate
portions of the lighting fixture which form no part of the
claimed design.

1 Claim, 6 Drawing Sheets

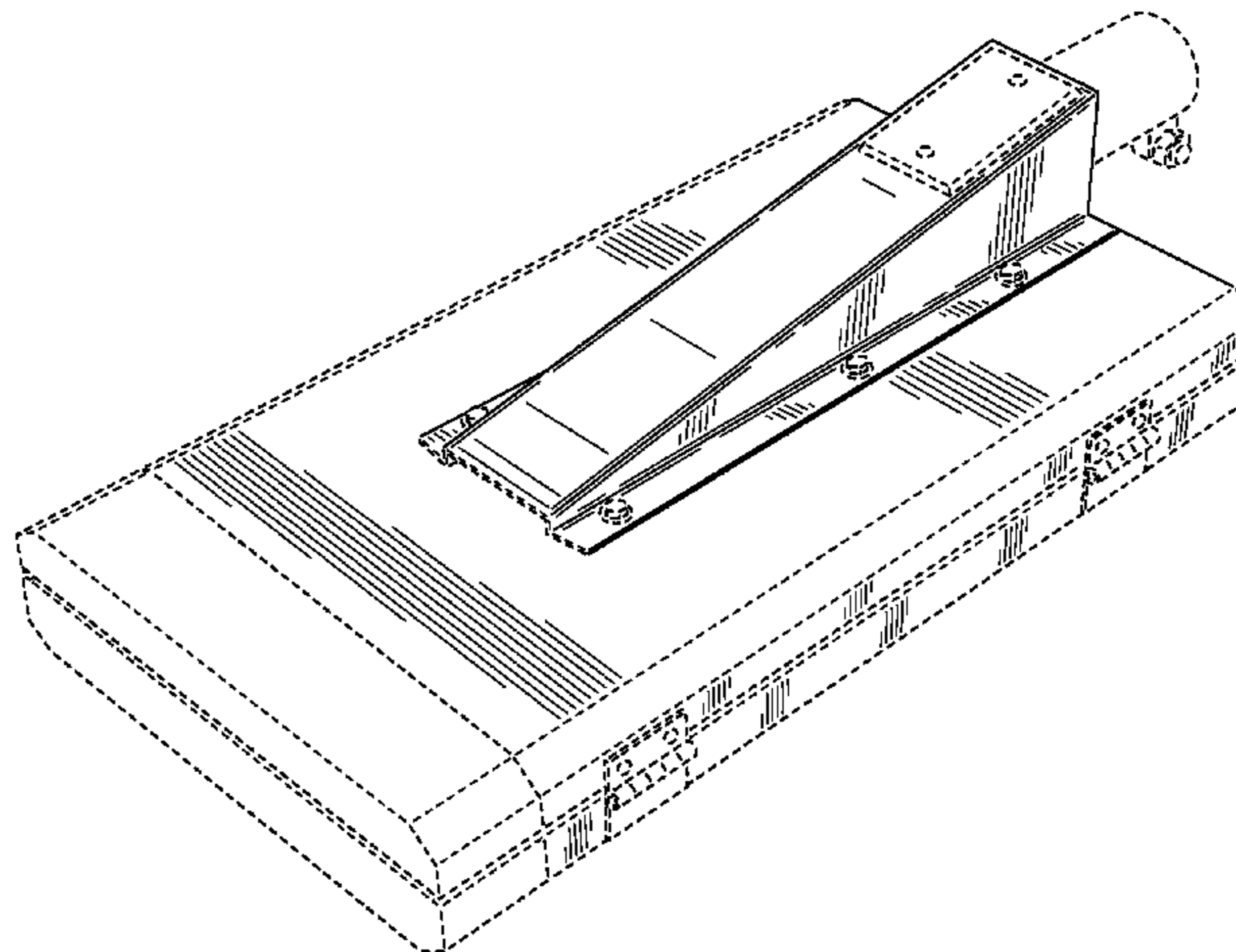
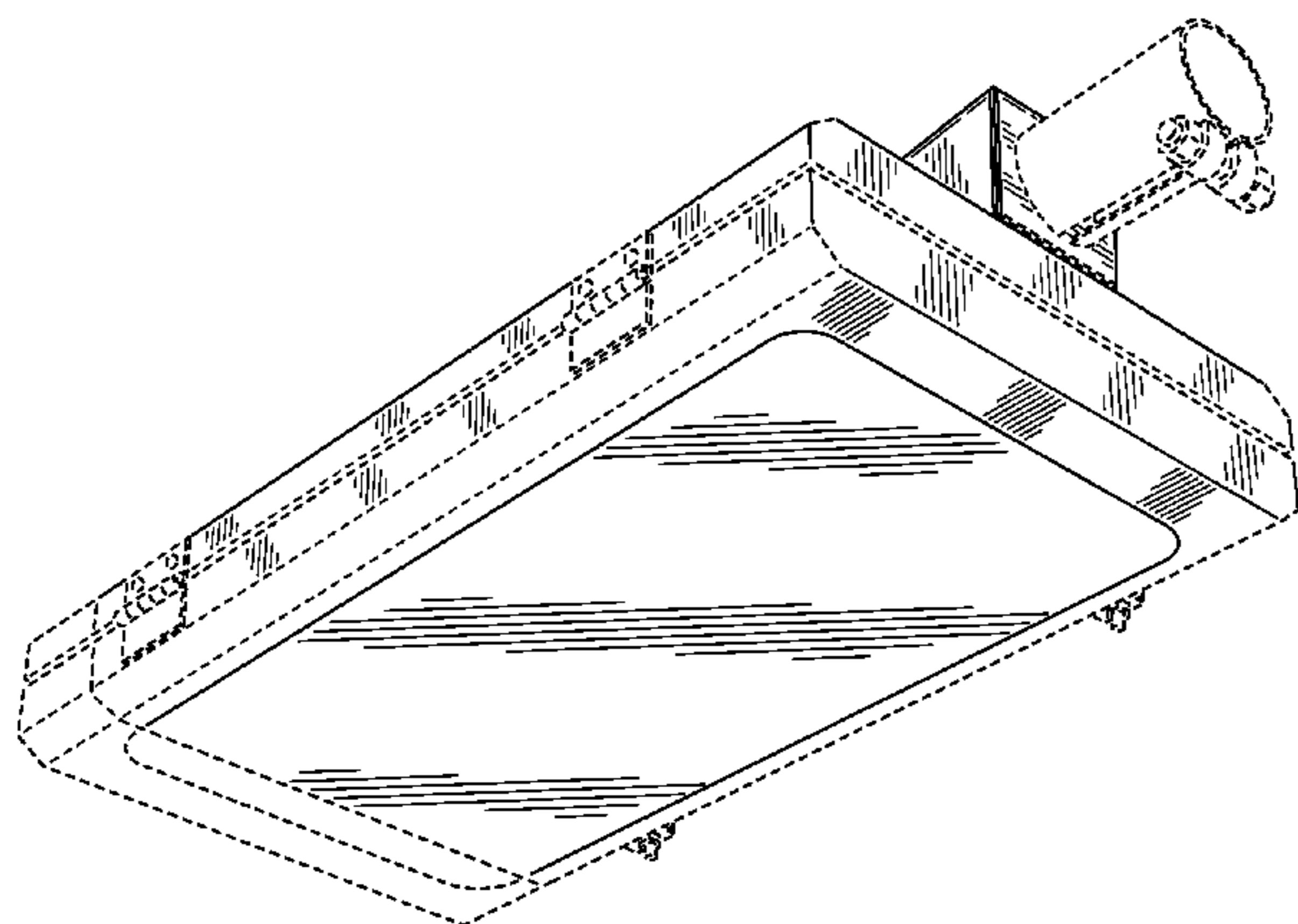

US D617,028 S

Page 2

U.S. PATENT DOCUMENTS

6,435,701 B1 *	8/2002	Chen	362/368	D576,330 S	9/2008	Ruud et al.	
D464,457 S	10/2002	Echito			D576,331 S *	9/2008	Ruud et al. D26/71
D464,757 S	10/2002	Echito			D576,332 S *	9/2008	Ruud et al. D26/72
6,601,976 B1 *	8/2003	Rhee	362/374	D598,161 S *	8/2009	Boyer et al. D26/138
D496,750 S	9/2004	Waldmann			D602,626 S *	10/2009	Santoro et al. D26/76
7,018,063 B2 *	3/2006	Michael et al.	362/183	D604,871 S *	11/2009	Denton D26/24
D521,171 S	5/2006	Skegin			D606,697 S *	12/2009	Verfuerth et al. D26/76
D531,342 S *	10/2006	Kauffman et al.	D26/68	D607,593 S *	1/2010	Yoo D26/71
D563,019 S	2/2008	Pfund			D607,594 S *	1/2010	Waldmann D26/76
D564,694 S	3/2008	Southern, Jr.			D609,841 S *	2/2010	Bush D26/76
D565,234 S	3/2008	Pfund et al.			2003/0002280 A1 *	1/2003	Paravantsos 362/223
D574,548 S *	8/2008	Wilcox et al.	D26/89	2005/0276049 A1	12/2005	Sun et al.	
					2009/0315485 A1 *	12/2009	Verfuerth et al. 315/320

* cited by examiner

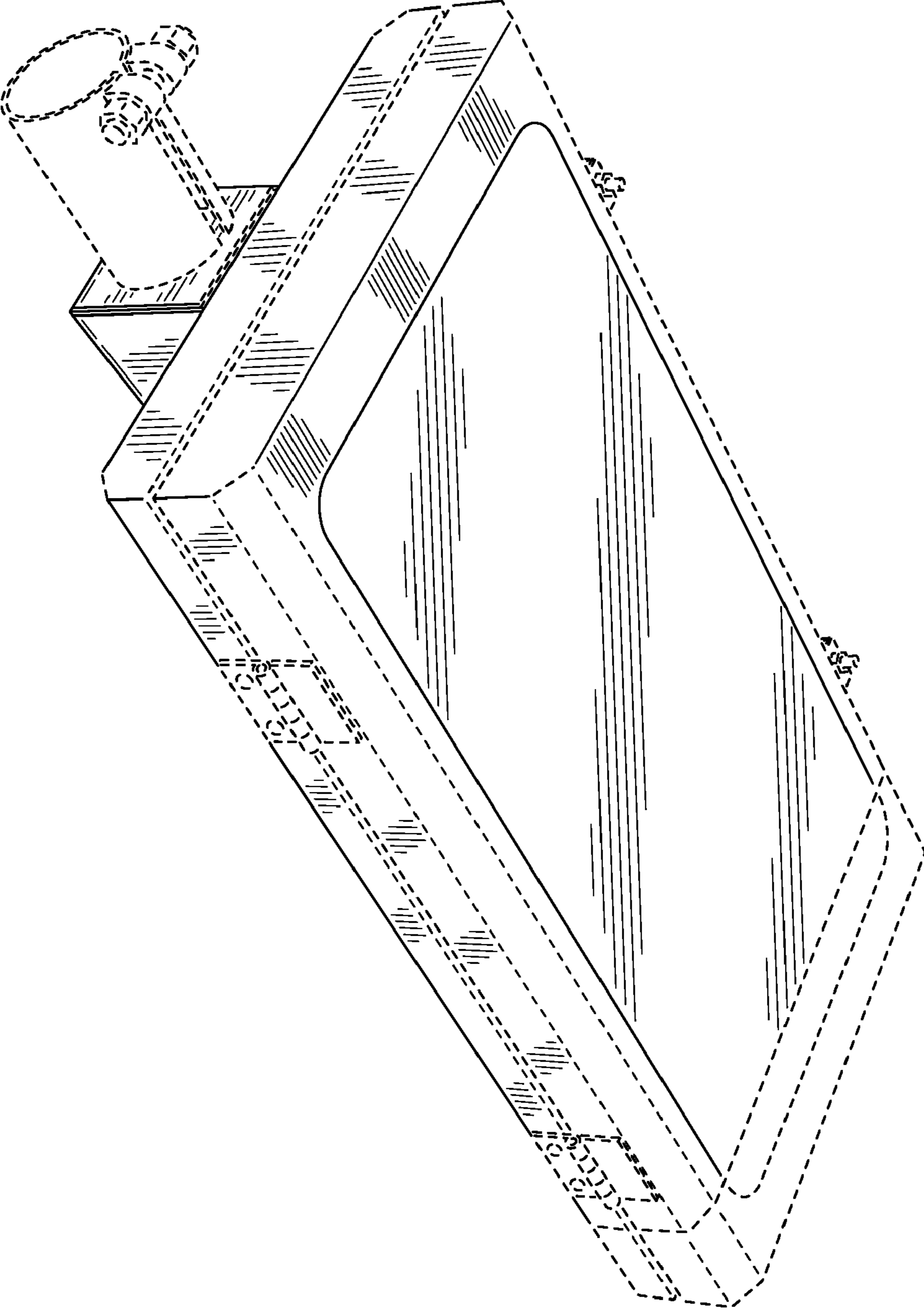

FIG. 1

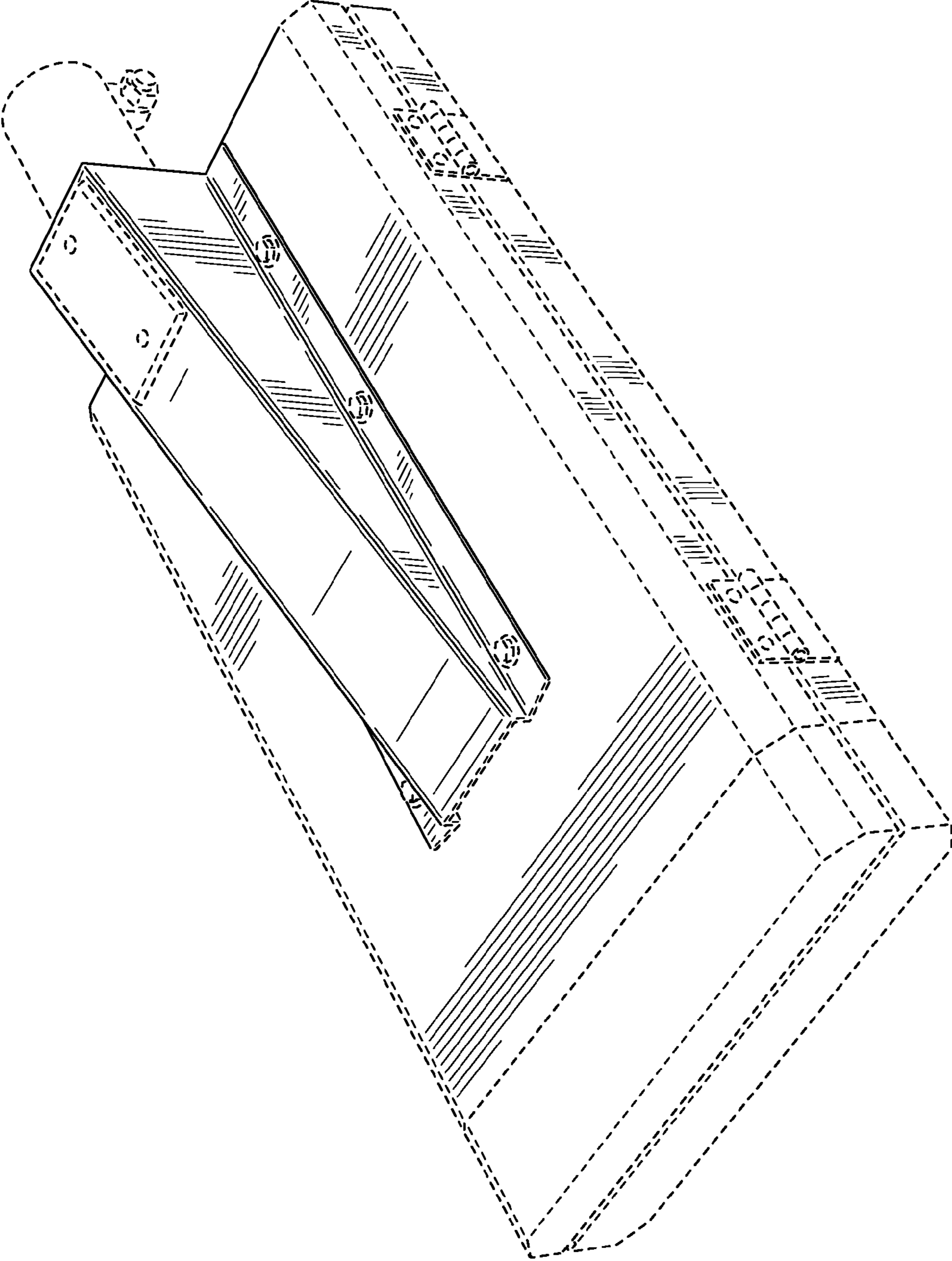

FIG. 2

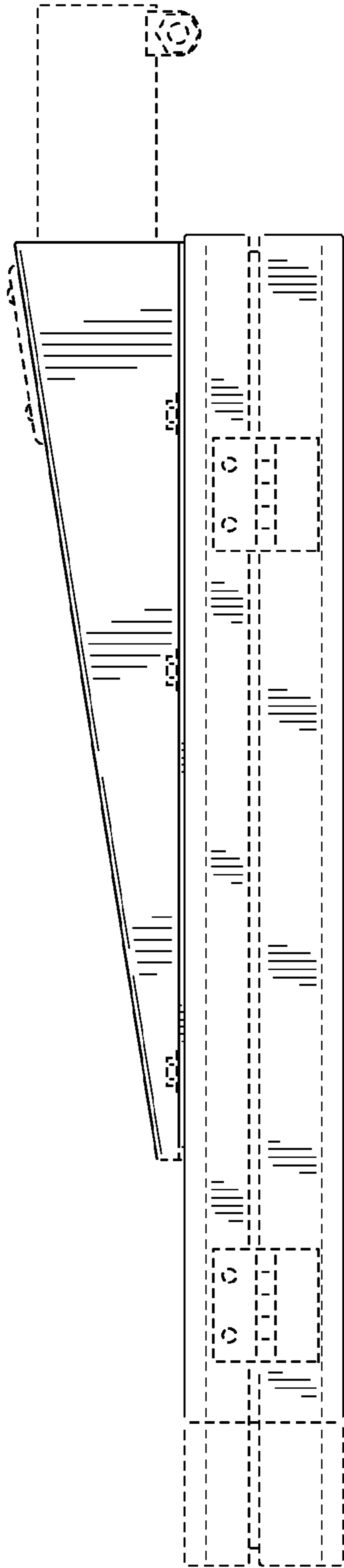

FIG. 3

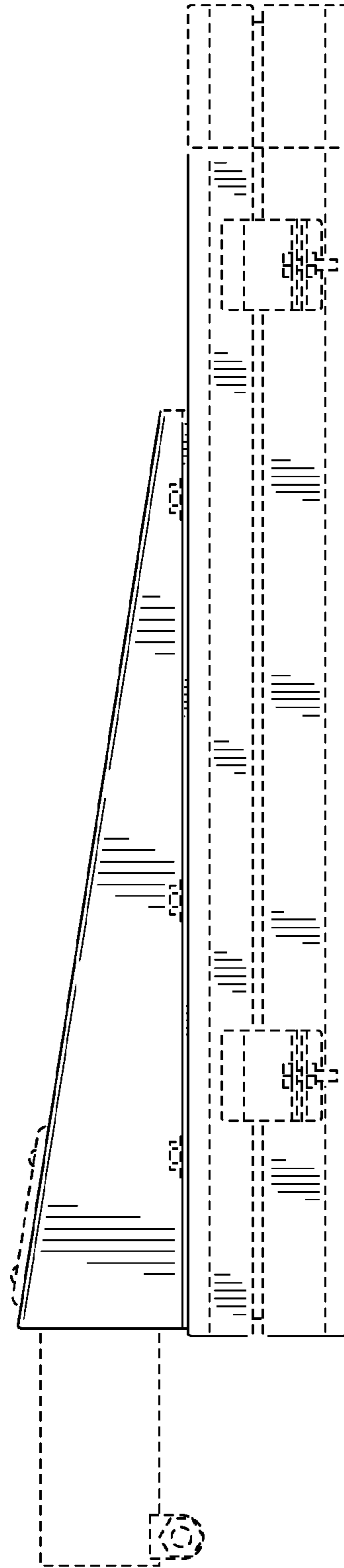

FIG. 4

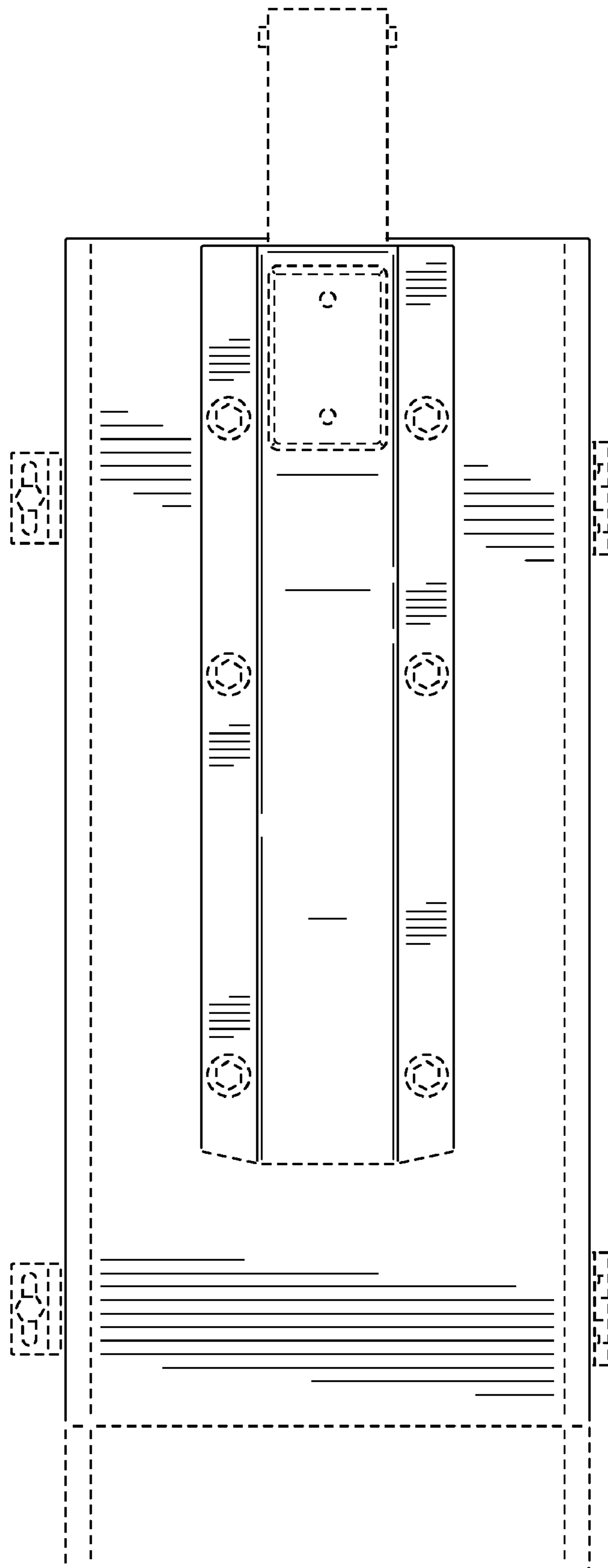

FIG. 5

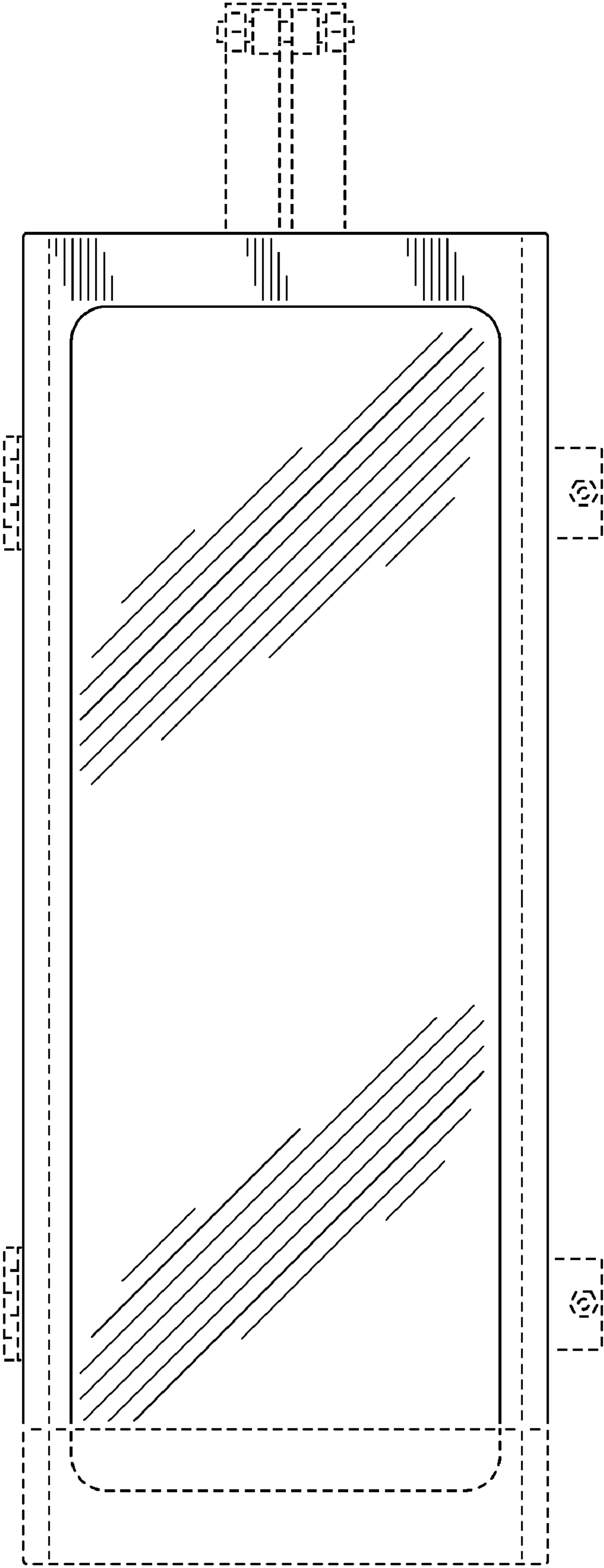

FIG. 6

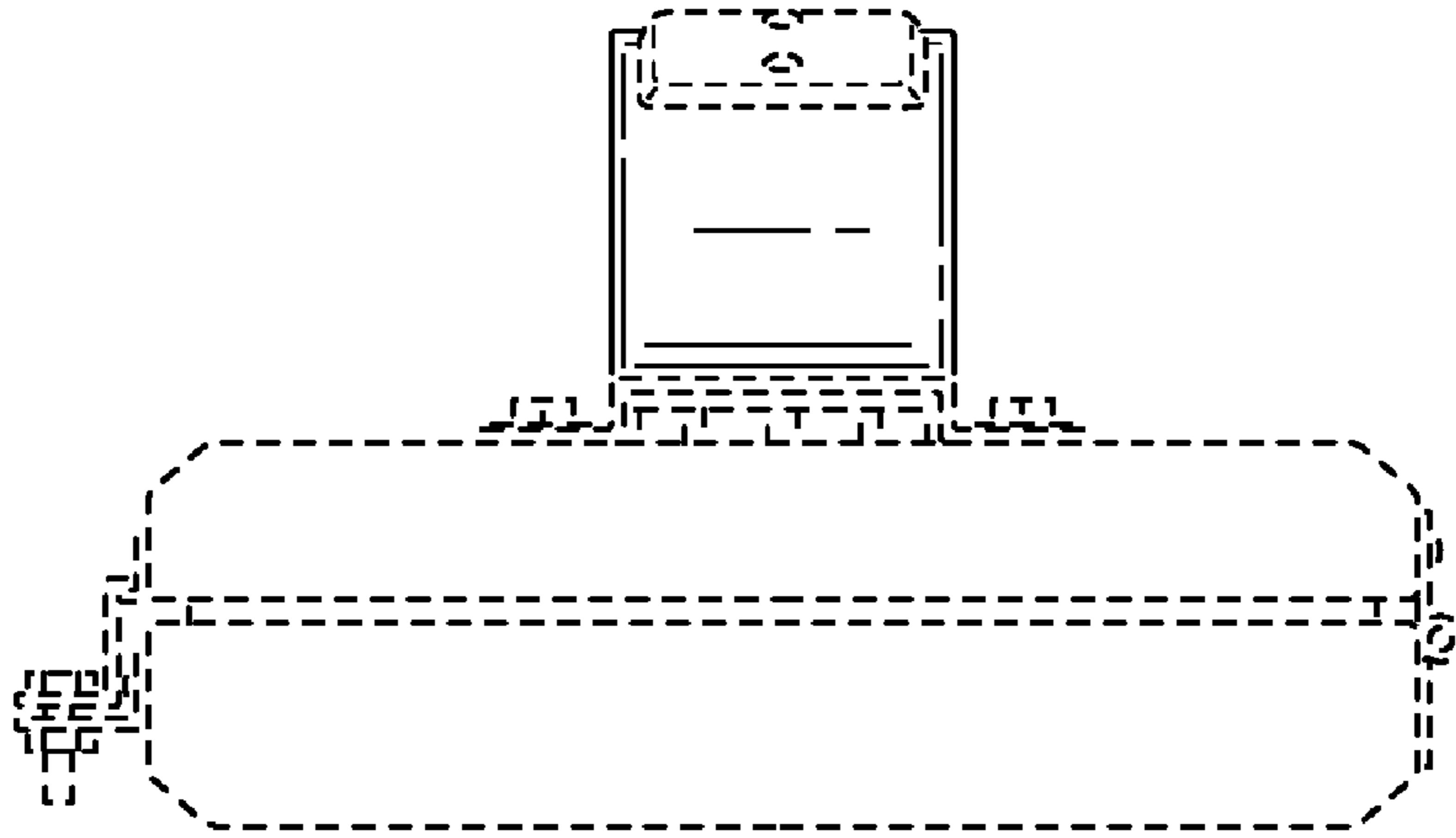

FIG. 7

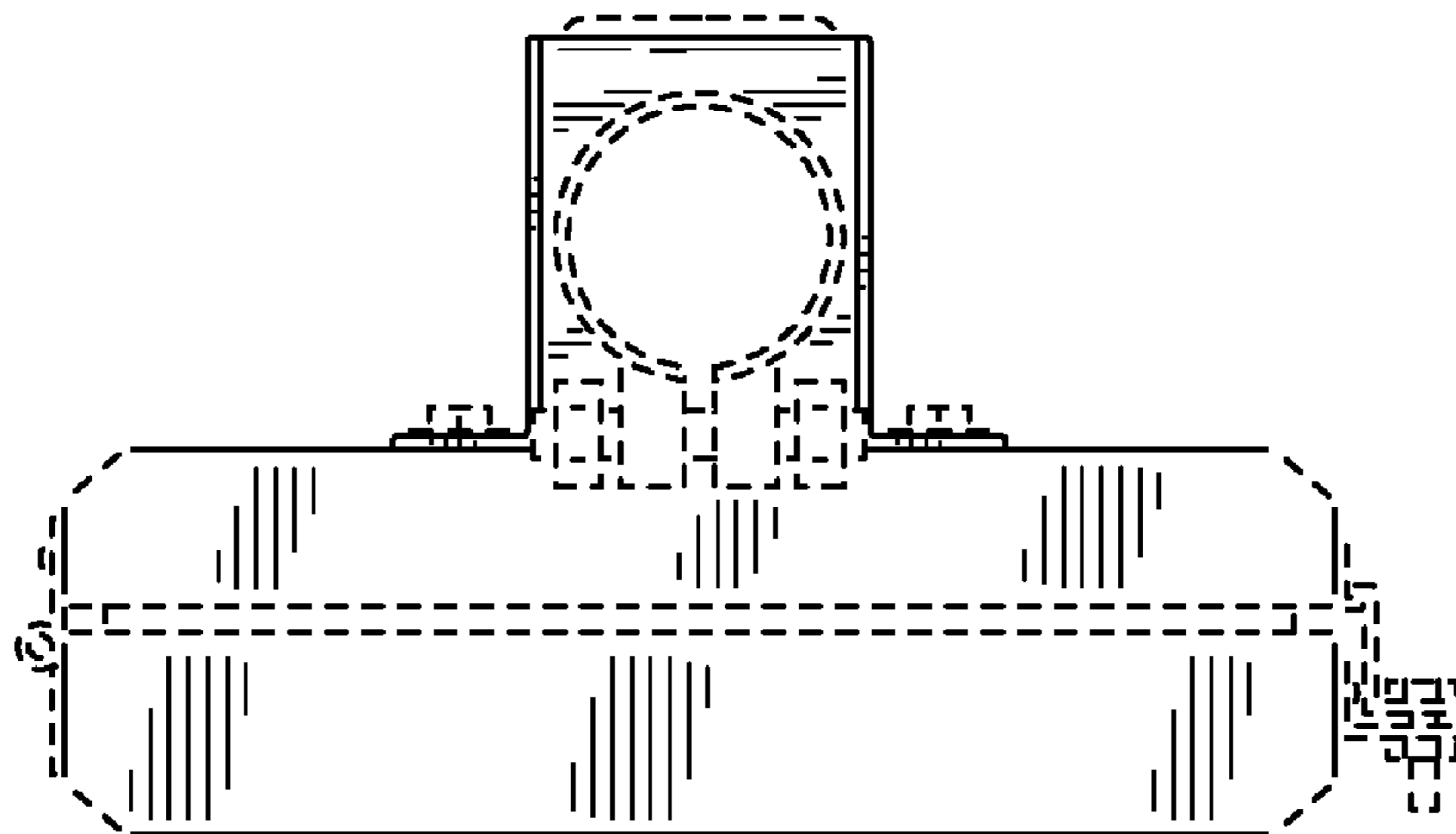

FIG. 8