



US00D616948S

(12) **United States Design Patent**  
**Brown**

(10) **Patent No.:** **US D616,948 S**  
(45) **Date of Patent:** **\*\* Jun. 1, 2010**

(54) **CHESS SET**

(75) Inventor: **Jeffrey Carl Brown**, Minneapolis, MN (US)

(73) Assignee: **Scythe, Inc.**, Minneapolis, MN (US)

(\*\*) Term: **14 Years**

(21) Appl. No.: **29/339,205**

(22) Filed: **Jun. 26, 2009**

**Related U.S. Application Data**

(63) Continuation-in-part of application No. 29/281,428, filed on Jun. 22, 2007, now Pat. No. Des. 598,960.

(51) **LOC (9) Cl.** ..... **21-01**

(52) **U.S. Cl.** ..... **D21/389**

(58) **Field of Classification Search** ..... D21/385-389;  
273/255, 260-261, 285-288

See application file for complete search history.

(56) **References Cited**

**U.S. PATENT DOCUMENTS**

2,342,899	A *	2/1944	Sands, Jr.	.....	273/260
D171,248	S *	1/1954	Cimillo	.....	D21/389
D172,810	S *	8/1954	Sellers	.....	D21/389
D174,817	S *	5/1955	Kenyon	.....	D21/389
2,964,323	A *	12/1960	Moses	.....	273/255
D266,012	S *	8/1982	Shyu	.....	D21/389

\* cited by examiner

*Primary Examiner*—Sandra Morris

(74) *Attorney, Agent, or Firm*—Jeffrey C. Brown, PLLC

(57) **CLAIM**

The ornamental design for a chess set, as shown and described.

**DESCRIPTION**

FIG. 1 is a reduced front view of the chess set, showing my new design;

FIG. 2 is a front view of the king piece, shown separately for ease of illustration;

FIG. 3 is a right side view thereof;

FIG. 4 is a rear view thereof;

FIG. 5 is a front view of the queen piece, shown separately for ease of illustration;

FIG. 6 is a left side view thereof;

FIG. 7 is a rear view thereof;

FIG. 8 is a front view of the bishop piece, shown separately for ease of illustration;

FIG. 9 is a right side view thereof;

FIG. 10 is a rear view thereof;

FIG. 11 is a right view of the knight piece, shown separately for ease of illustration;

FIG. 12 is a front view thereof;

FIG. 13 is a top view thereof;

FIG. 14 is a front view of the rook piece, shown separately for ease of illustration, the other sides being identical;

FIG. 15 is a top view thereof;

FIG. 16 is a front view of the pawn piece, shown separately for ease of illustration;

FIG. 17 is a right side view thereof; and,

FIG. 18 is a rear view thereof.

The broken line showing is for illustrative purposes only, and forms not part of the claimed design.

**1 Claim, 7 Drawing Sheets**

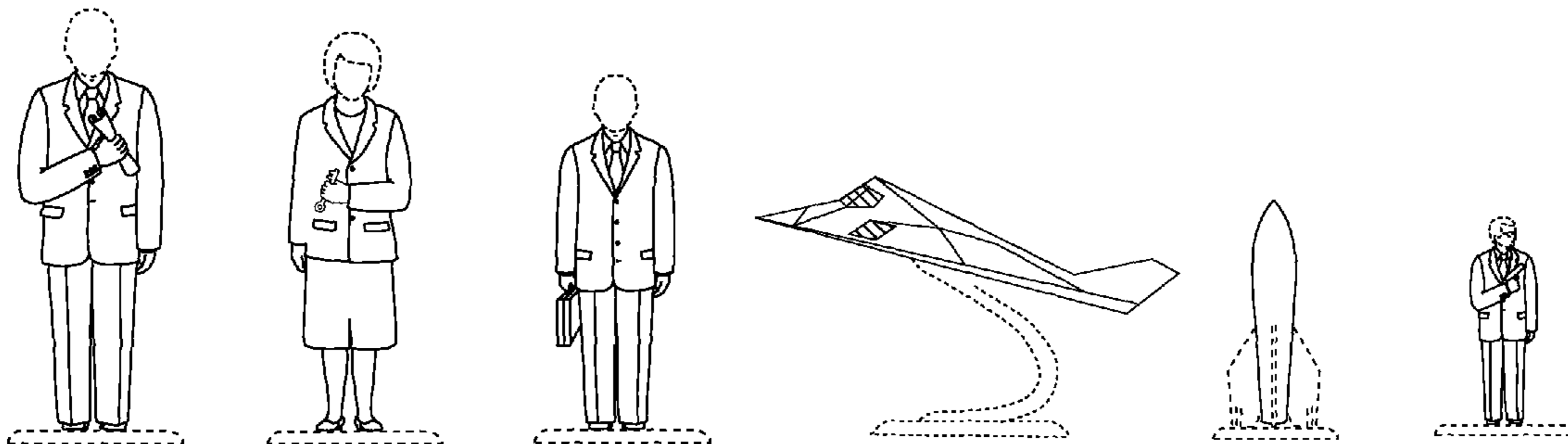

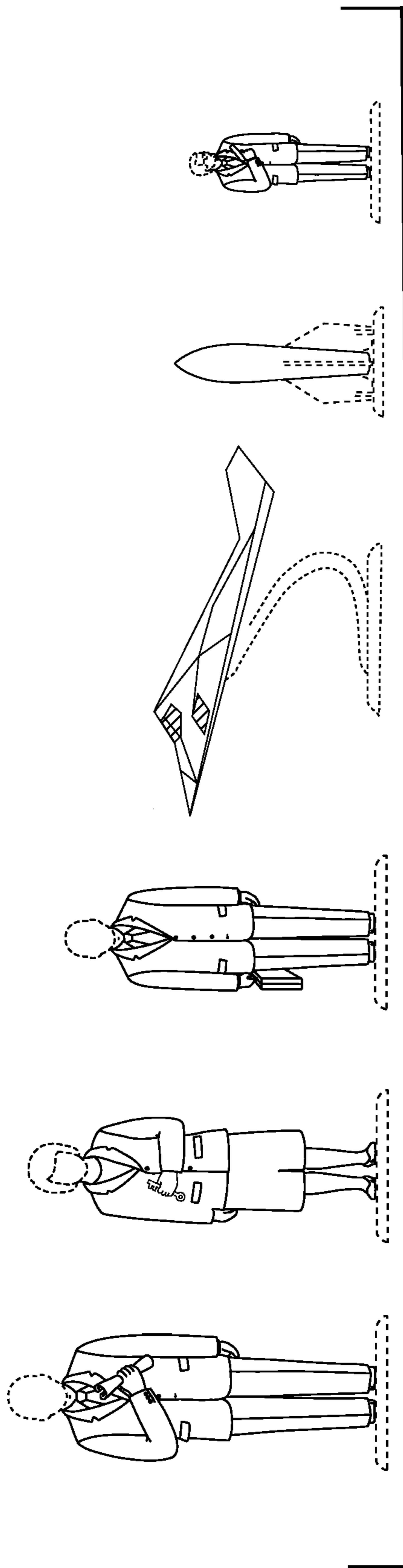

Fig. 1

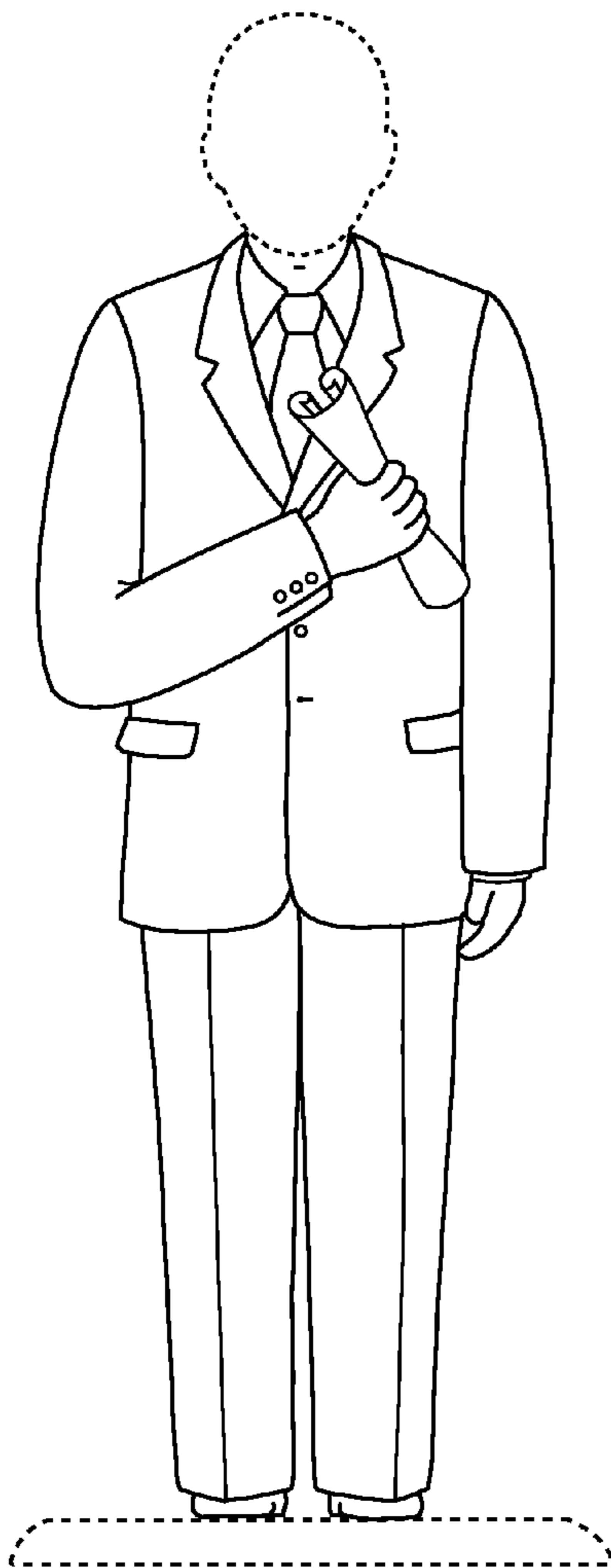

Fig. 2

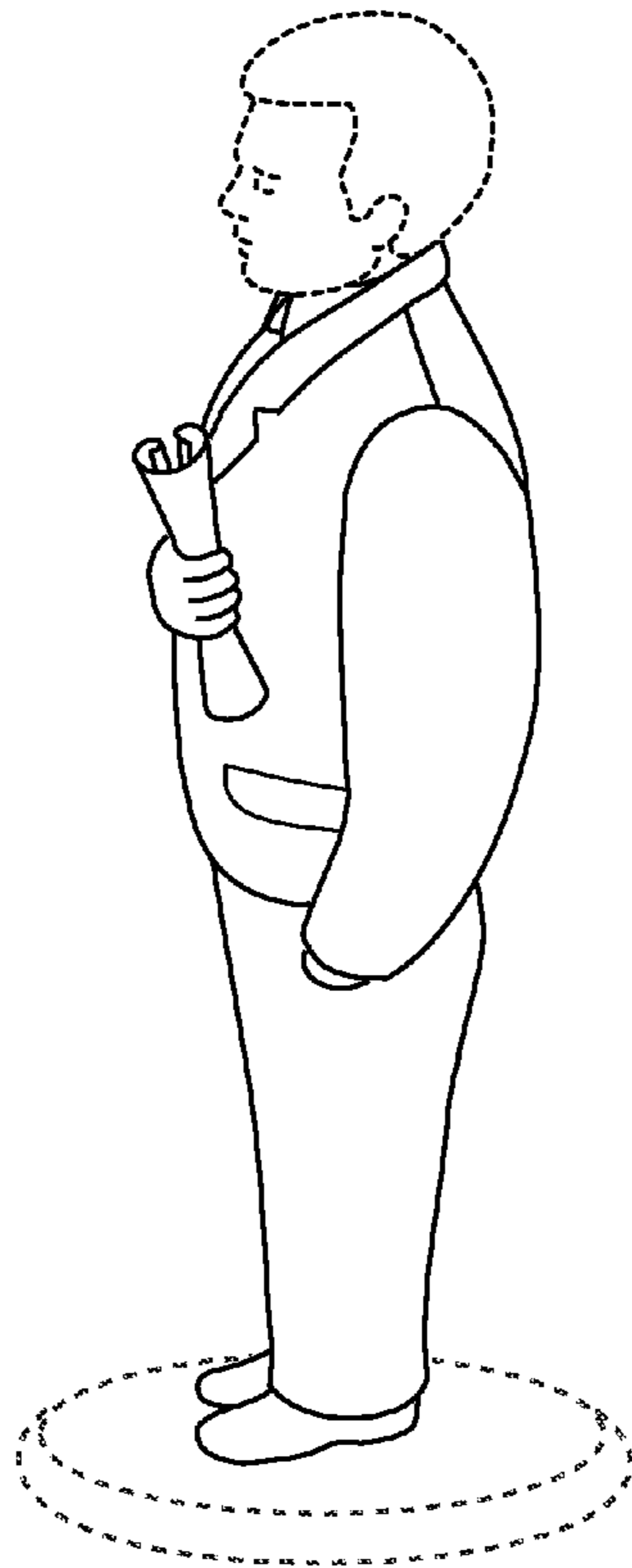

Fig. 3

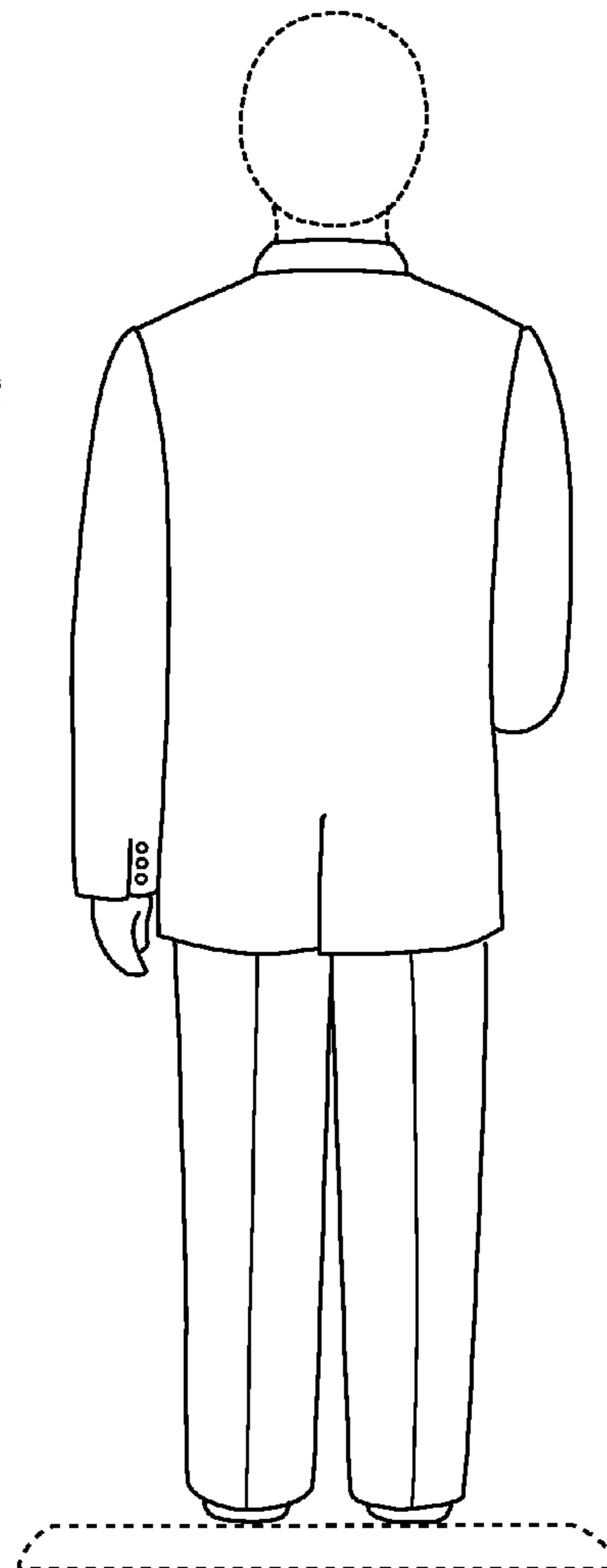

Fig. 4

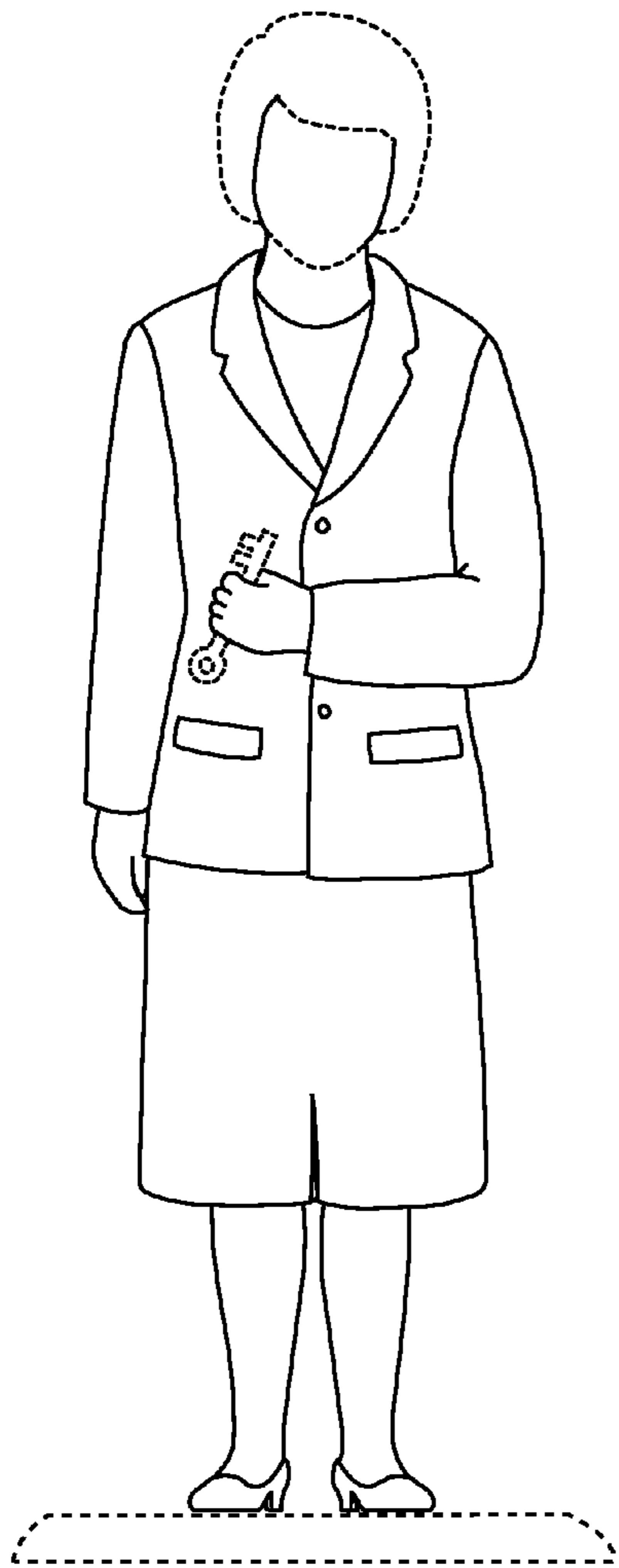

Fig. 5

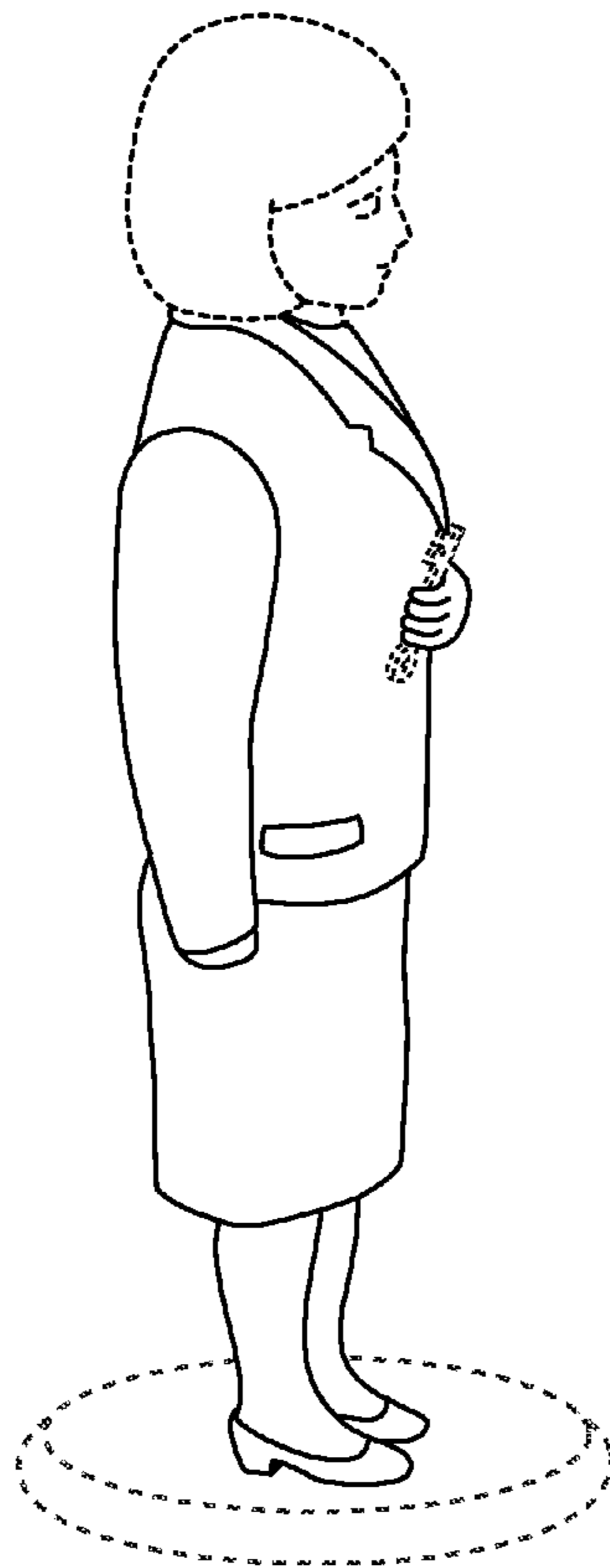

Fig. 6

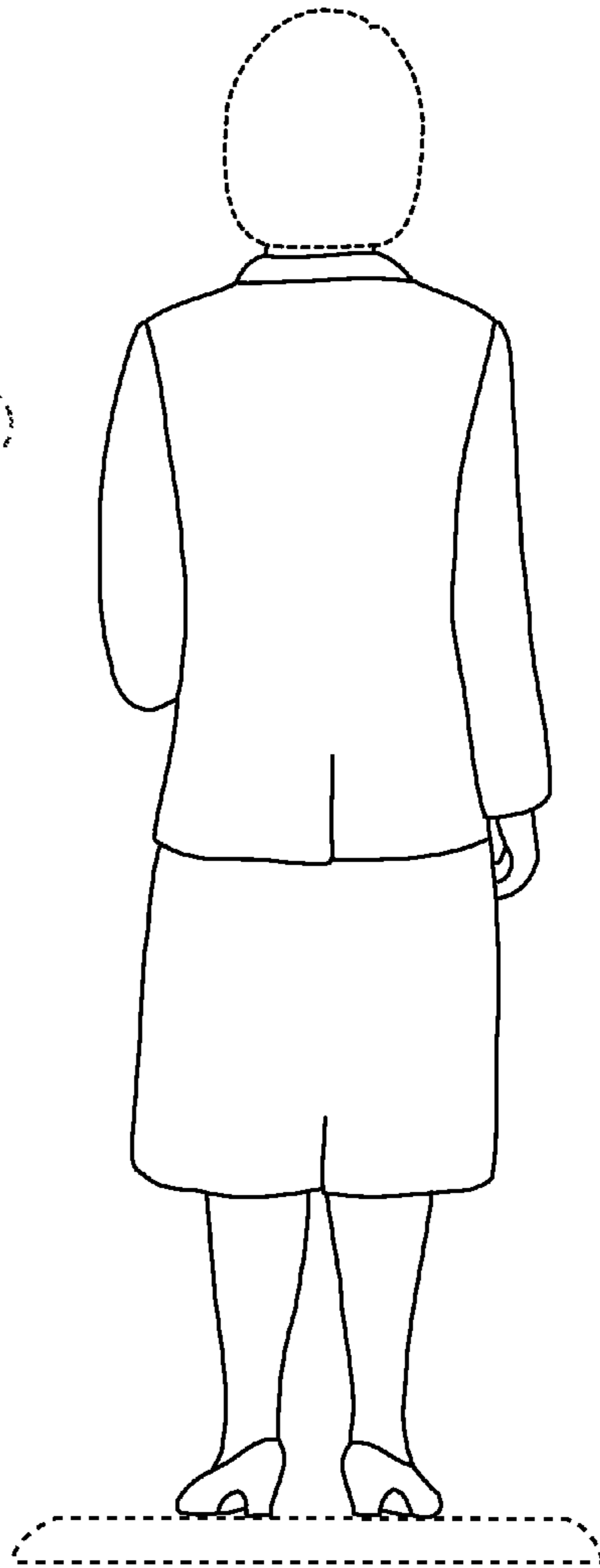

Fig. 7

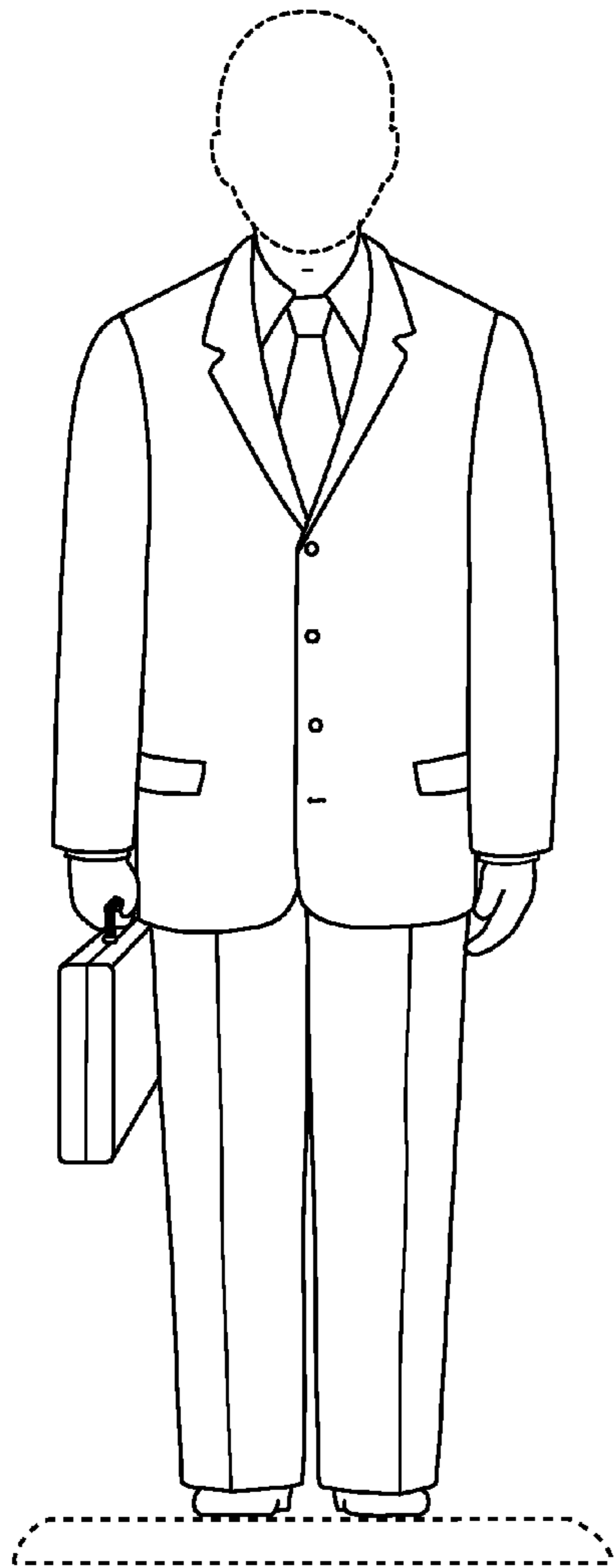

Fig. 8

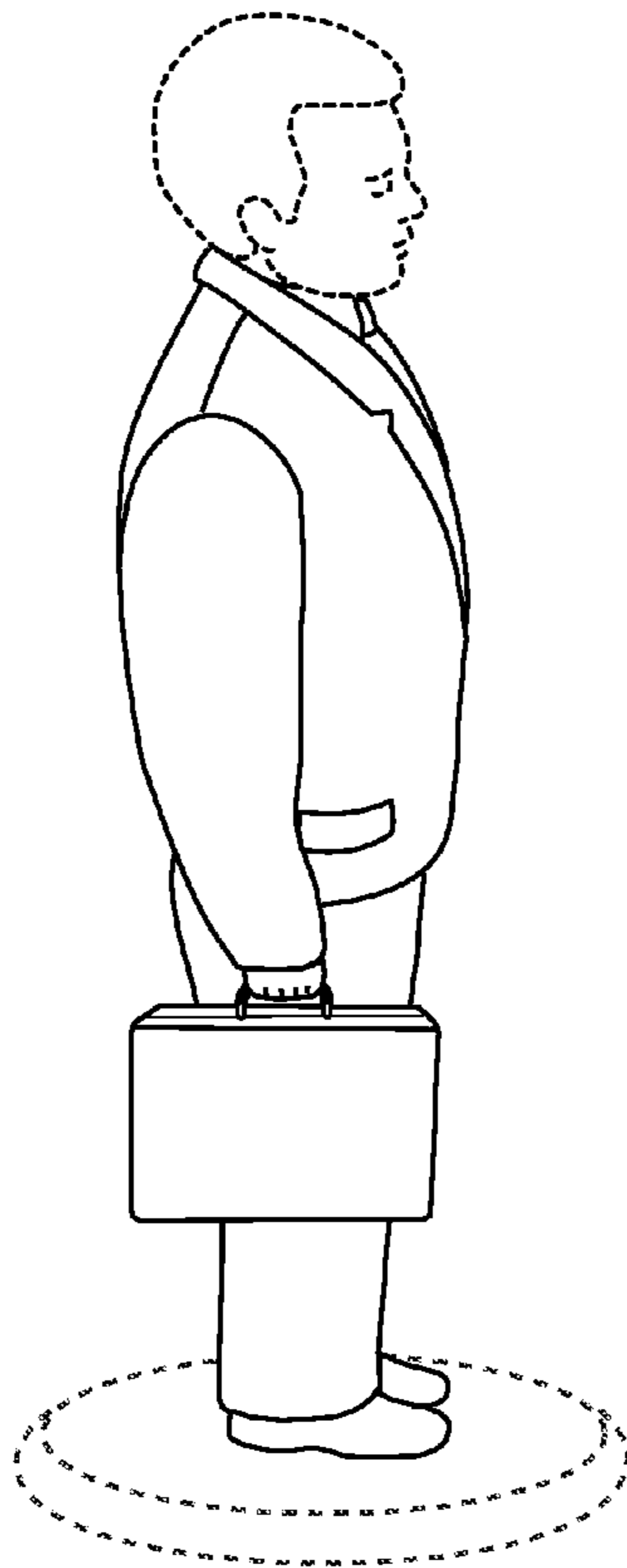

Fig. 9

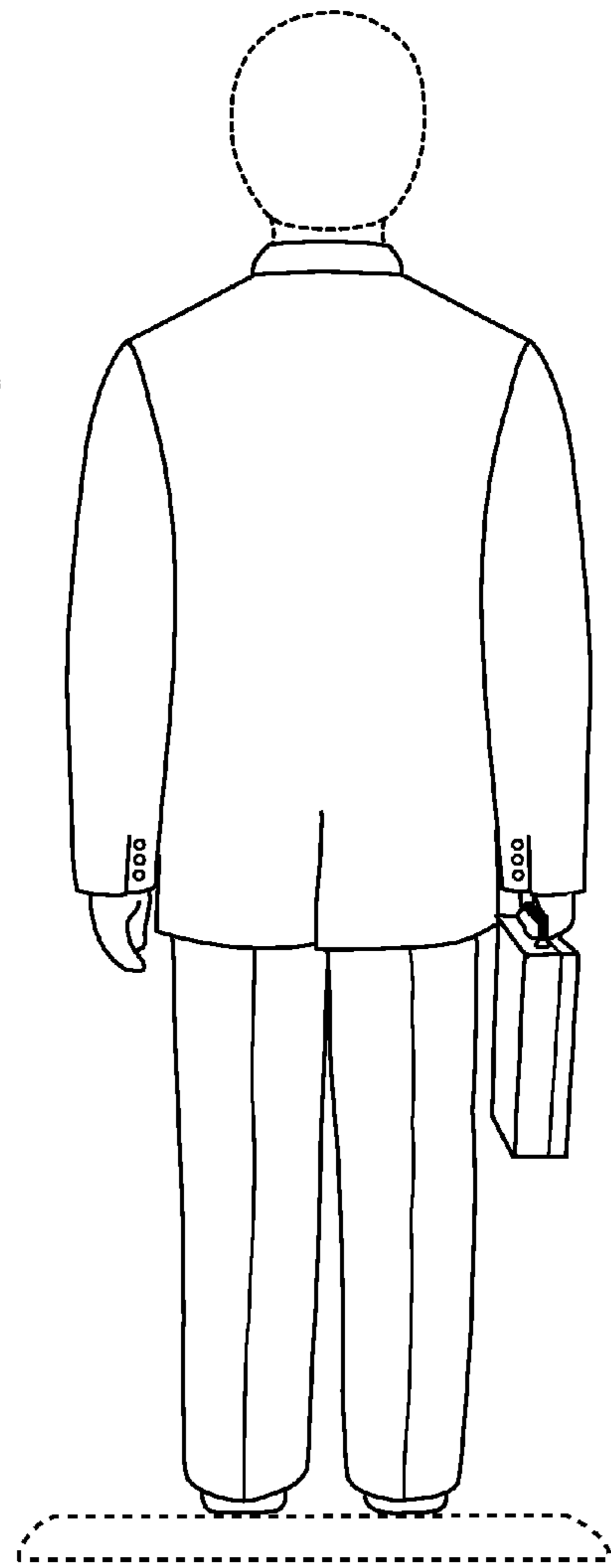

Fig. 10

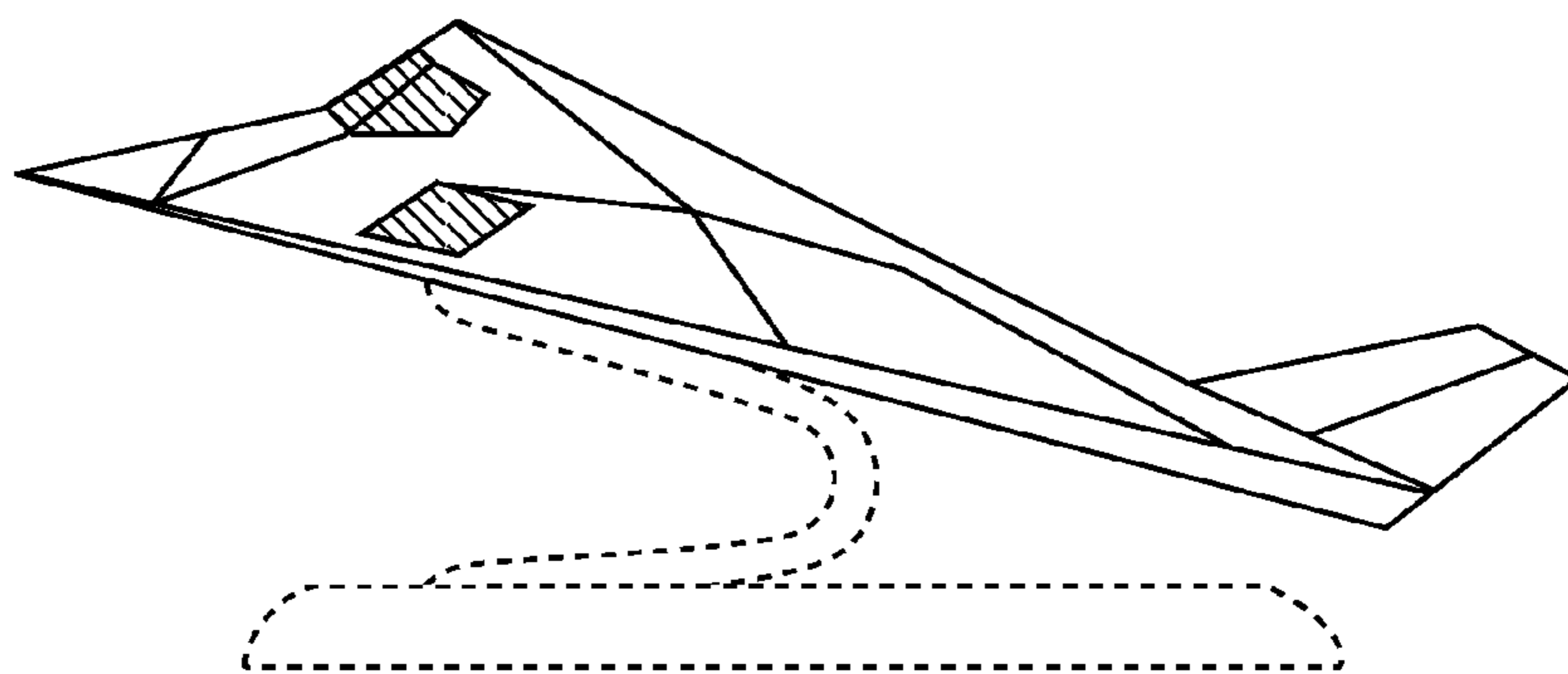

Fig. 11

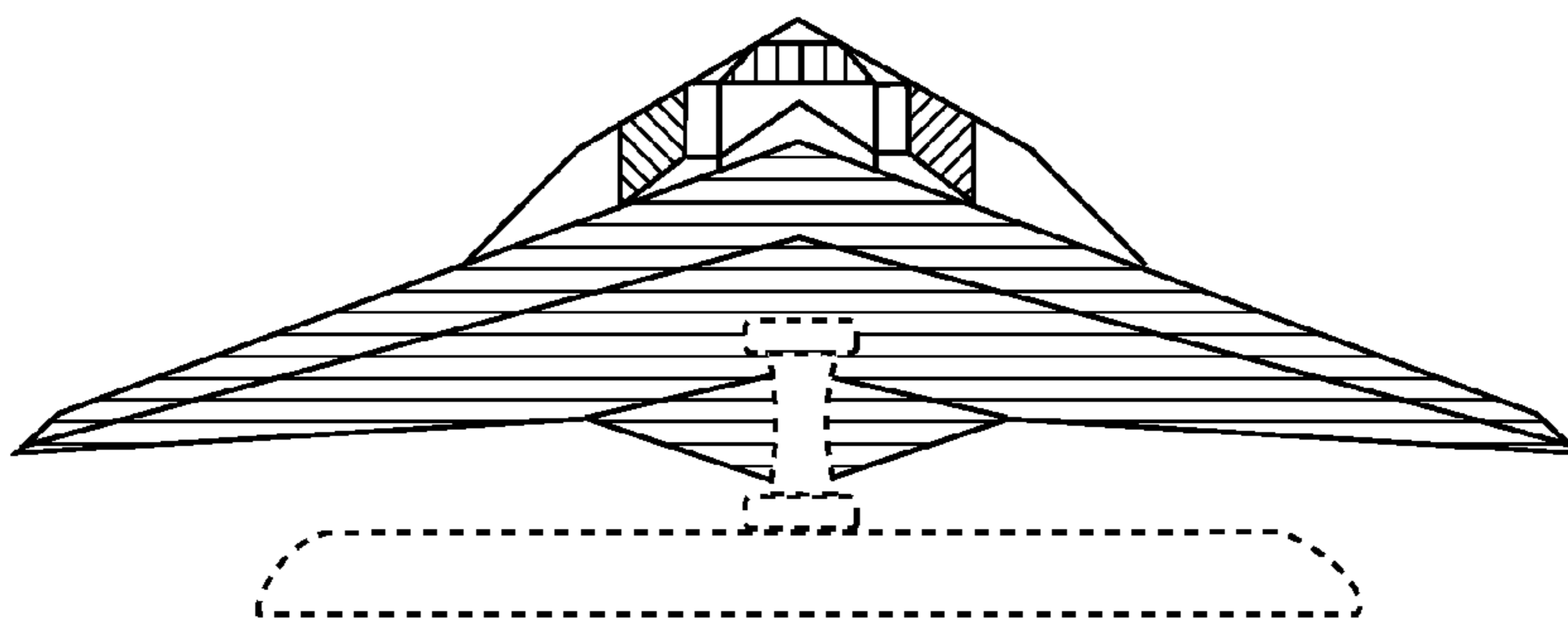

Fig. 12

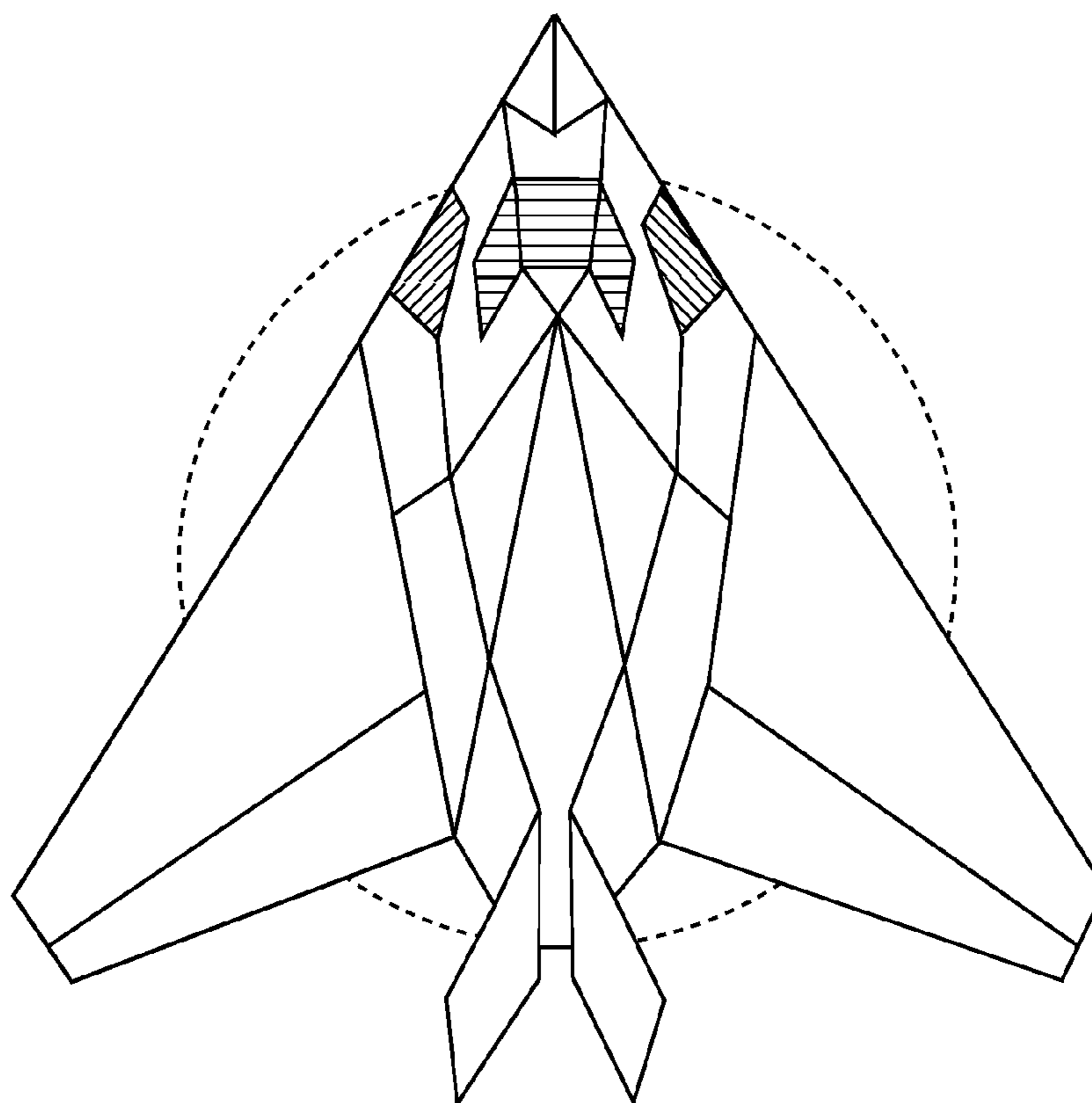

Fig. 13

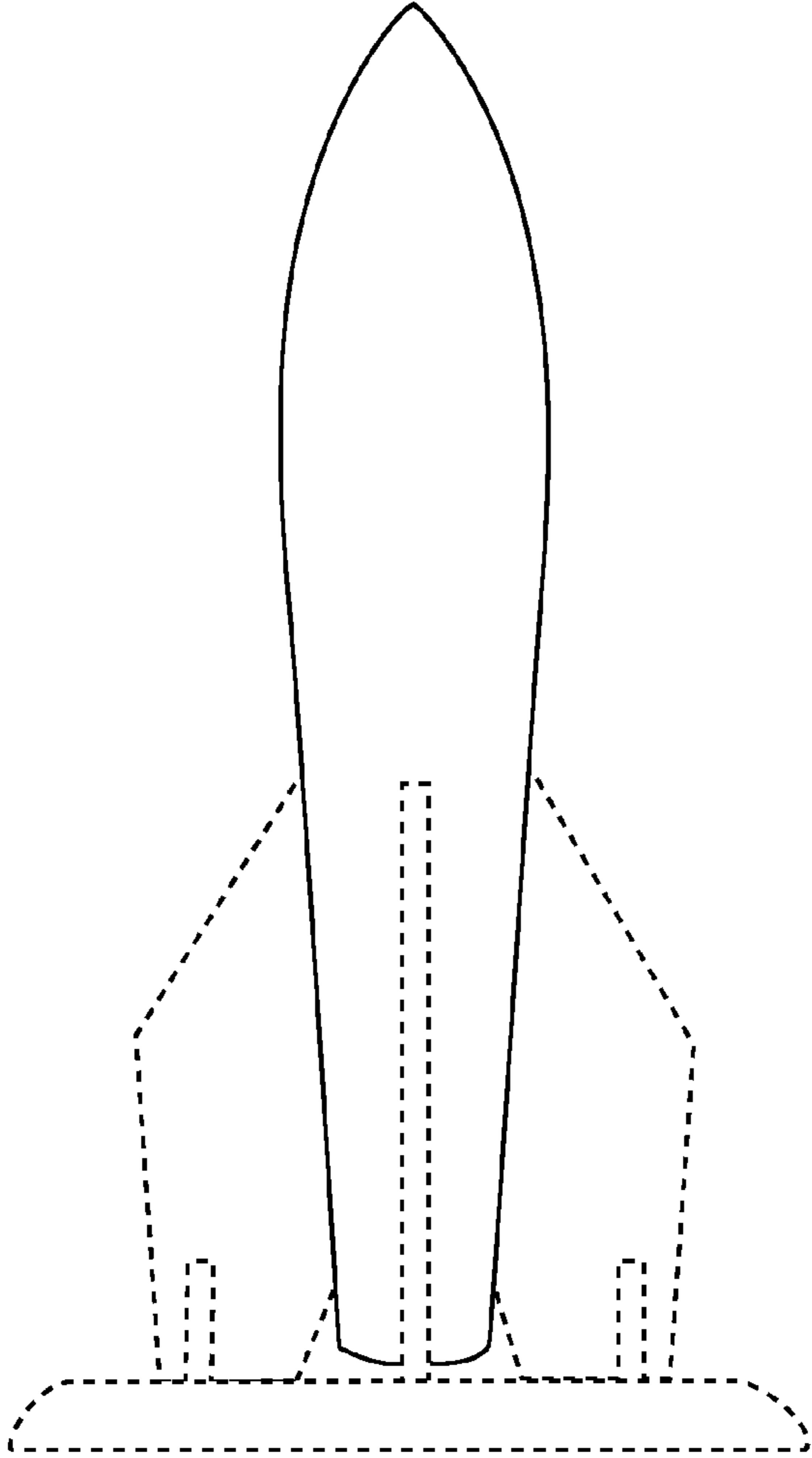

Fig. 14

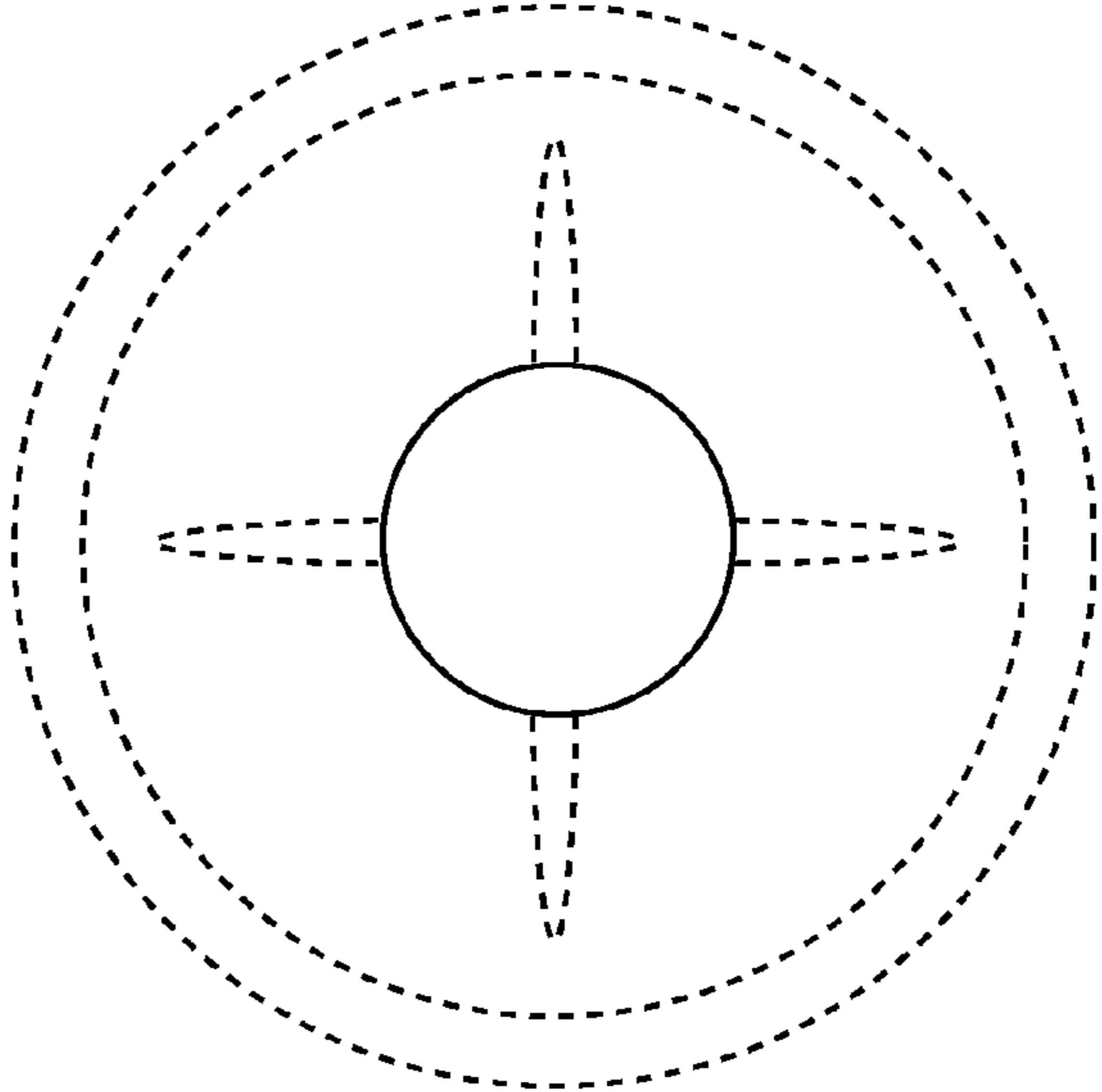

Fig. 15

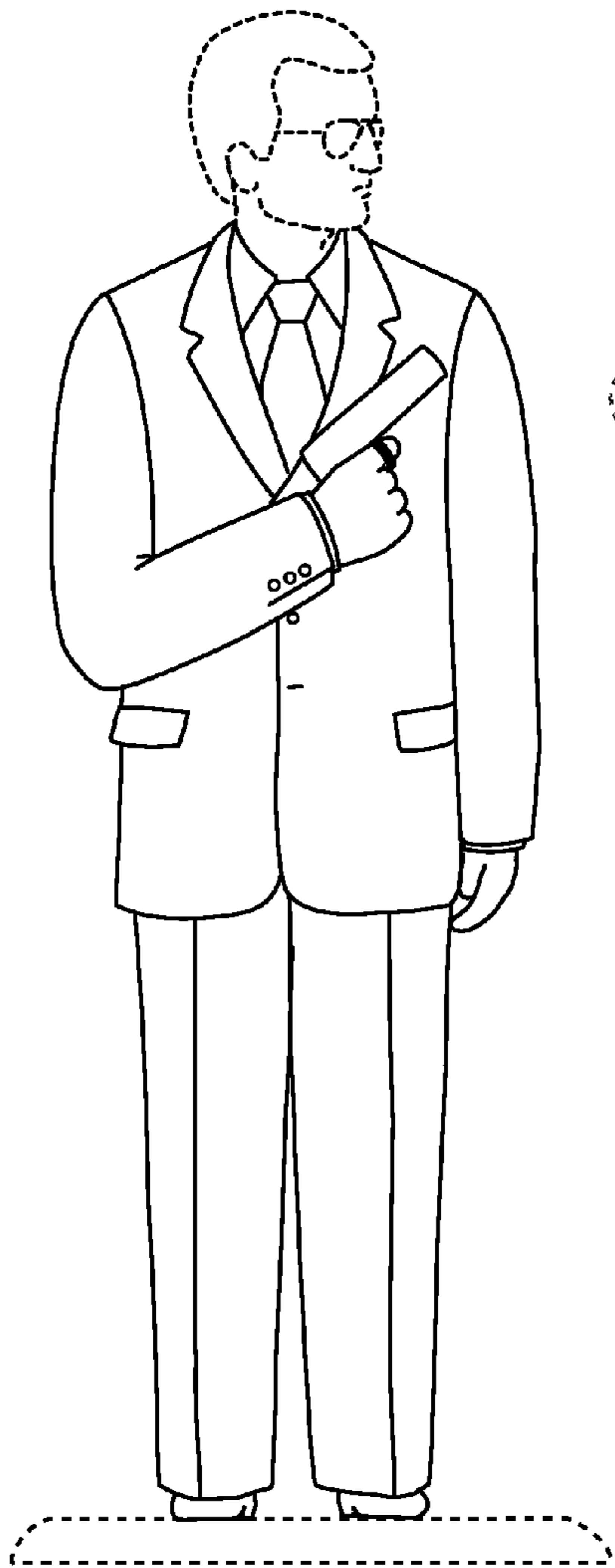

Fig. 16

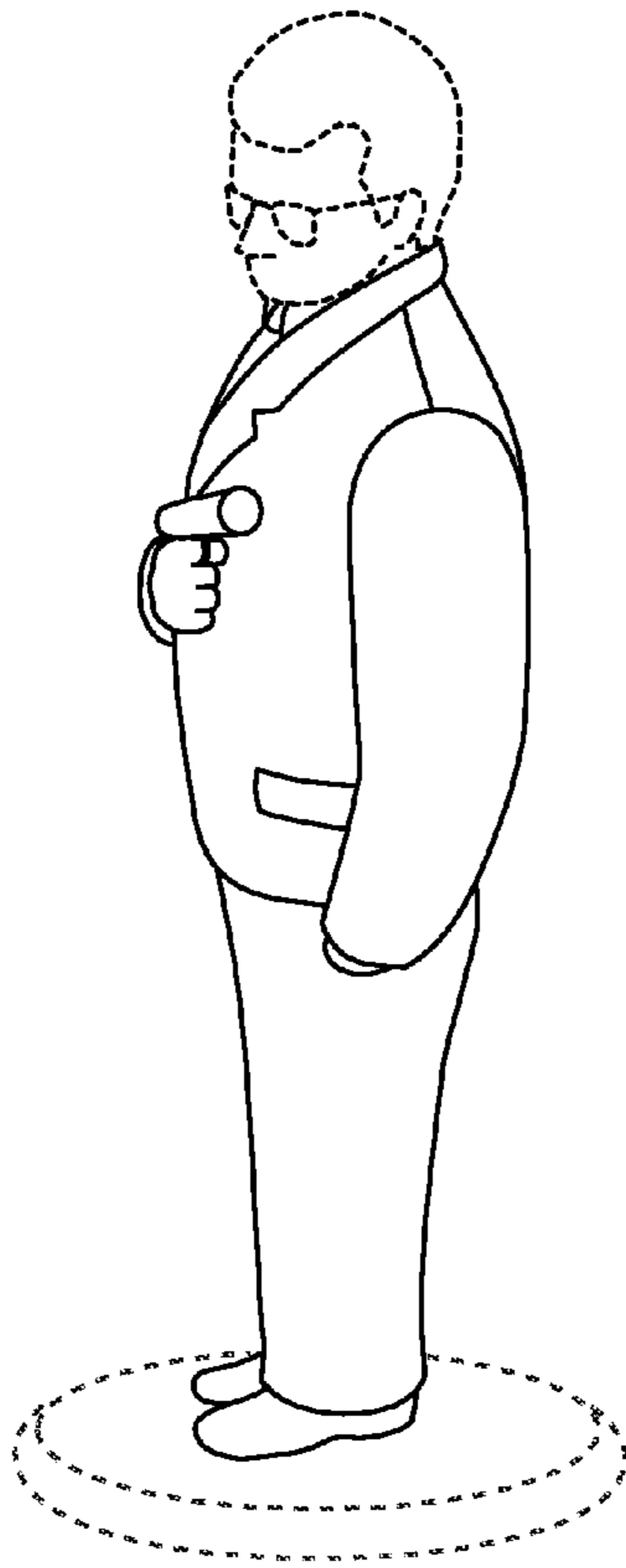

Fig. 17

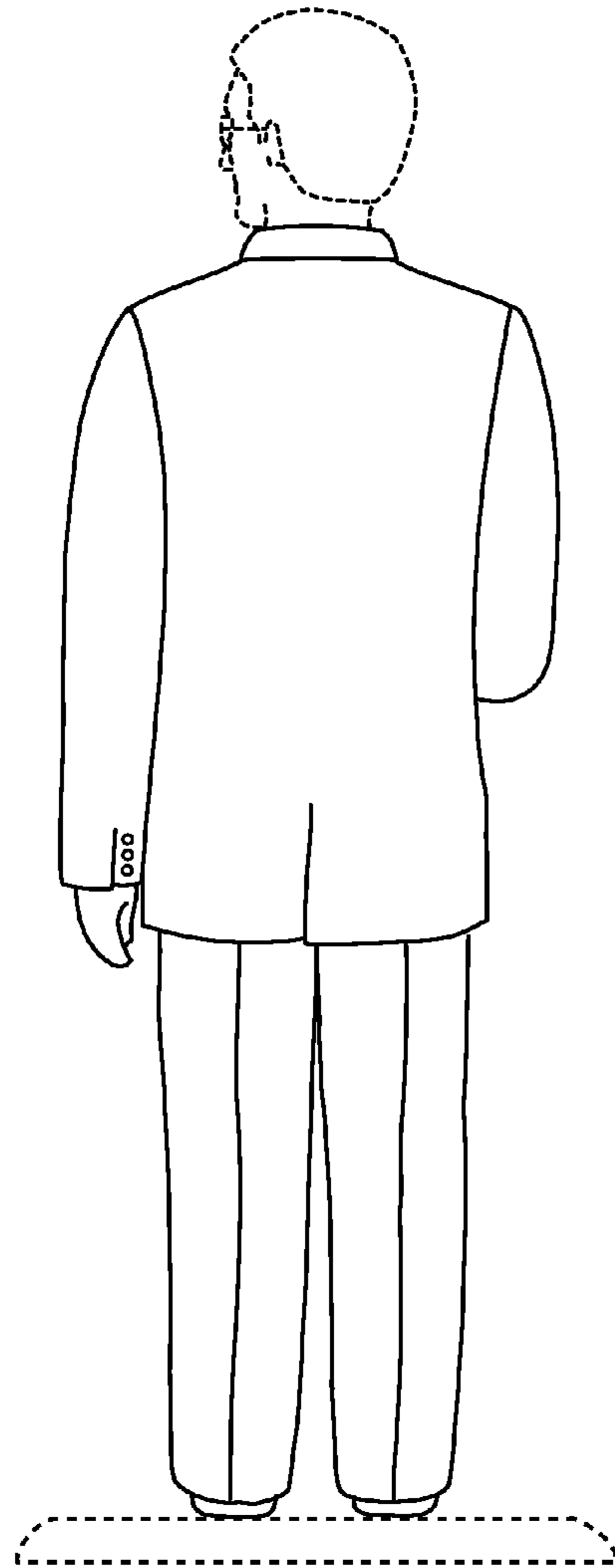

Fig. 18