



US00D616926S

(12) **United States Design Patent**
Holderfield et al.

(10) **Patent No.:** **US D616,926 S**
(45) **Date of Patent:** **** Jun. 1, 2010**

(54) **SHREDDER**

(75) Inventors: **Gregory Holderfield**, Oak Park, IL (US); **Joey Nakayama**, Chicago, IL (US); **Adam M. Ruggles**, Chicago, IL (US); **Van Hiles**, Elgin, IL (US)

(73) Assignee: **Fellowes, Inc.**, Itasca, IL (US)

(**) Term: **14 Years**

(21) Appl. No.: **29/336,870**

(22) Filed: **May 11, 2009**

(51) **LOC (9) Cl.** **18-03**

(52) **U.S. Cl.** **D18/34.5**

(58) **Field of Classification Search** D18/34.1–34.9;
241/100, 236, 101.78, 36; 83/613, 614, 623,
83/485, 57–68; 30/294, 296.1, 275.4, 276
See application file for complete search history.

(56) **References Cited**

U.S. PATENT DOCUMENTS

D265,909	S	*	8/1982	Hatanaka	D18/34.6
D265,911	S	*	8/1982	Hatanaka	D18/34.6
4,964,579	A	*	10/1990	Strohmeier	241/100
D498,253	S	*	11/2004	Lo	D18/34.6
D556,250	S	*	11/2007	Kent et al.	D18/34.6
D583,859	S	*	12/2008	Holderfield et al.	D18/34.9
D591,335	S		4/2009	Holderfield et al.		
D598,048	S	*	8/2009	Holderfield et al.	D18/34.9
7,594,620	B2	*	9/2009	Abramson et al.	241/36
D602,073	S	*	10/2009	Holderfield et al.	D18/34.5
D602,518	S	*	10/2009	Holderfield et al.	D18/34.9
D604,763	S	*	11/2009	Holderfield et al.	D18/34.9

* cited by examiner

Primary Examiner—Charles A Rademaker

(74) *Attorney, Agent, or Firm*—Pillsbury Winthrop Shaw Pittman LLP

(57) **CLAIM**

The ornamental design for a shredder, as shown and described.

DESCRIPTION

FIG. 1 is a right side perspective view of a shredder showing our new design;

FIG. 2 is a front elevation view of the shredder of FIG. 1;

FIG. 3 is a rear elevation view of the shredder of FIG. 1;

FIG. 4 is a right profile view of the shredder of FIG. 1;

FIG. 5 is a left profile view of the shredder of FIG. 1;

FIG. 6 is a top plan view of the shredder of FIG. 1;

FIG. 7 is a bottom plan view of the shredder of FIG. 1;

FIG. 8 is a right side perspective view of a modified embodiment of the design shown in FIGS. 1 through 7;

FIG. 9 is a front elevation view of the shredder of FIG. 8;

FIG. 10 is a rear elevation view of the shredder of FIG. 8;

FIG. 11 is a right profile view of the shredder of FIG. 8;

FIG. 12 is a left profile view of the shredder of FIG. 8;

FIG. 13 is a top plan view of the shredder of FIG. 8; and,

FIG. 14 is a bottom plan view of the shredder of FIG. 8.

The broken lines shown in FIGS. 8 through 14 are included for the purpose of illustrating structural environment and form no part of the claimed design.

1 Claim, 14 Drawing Sheets

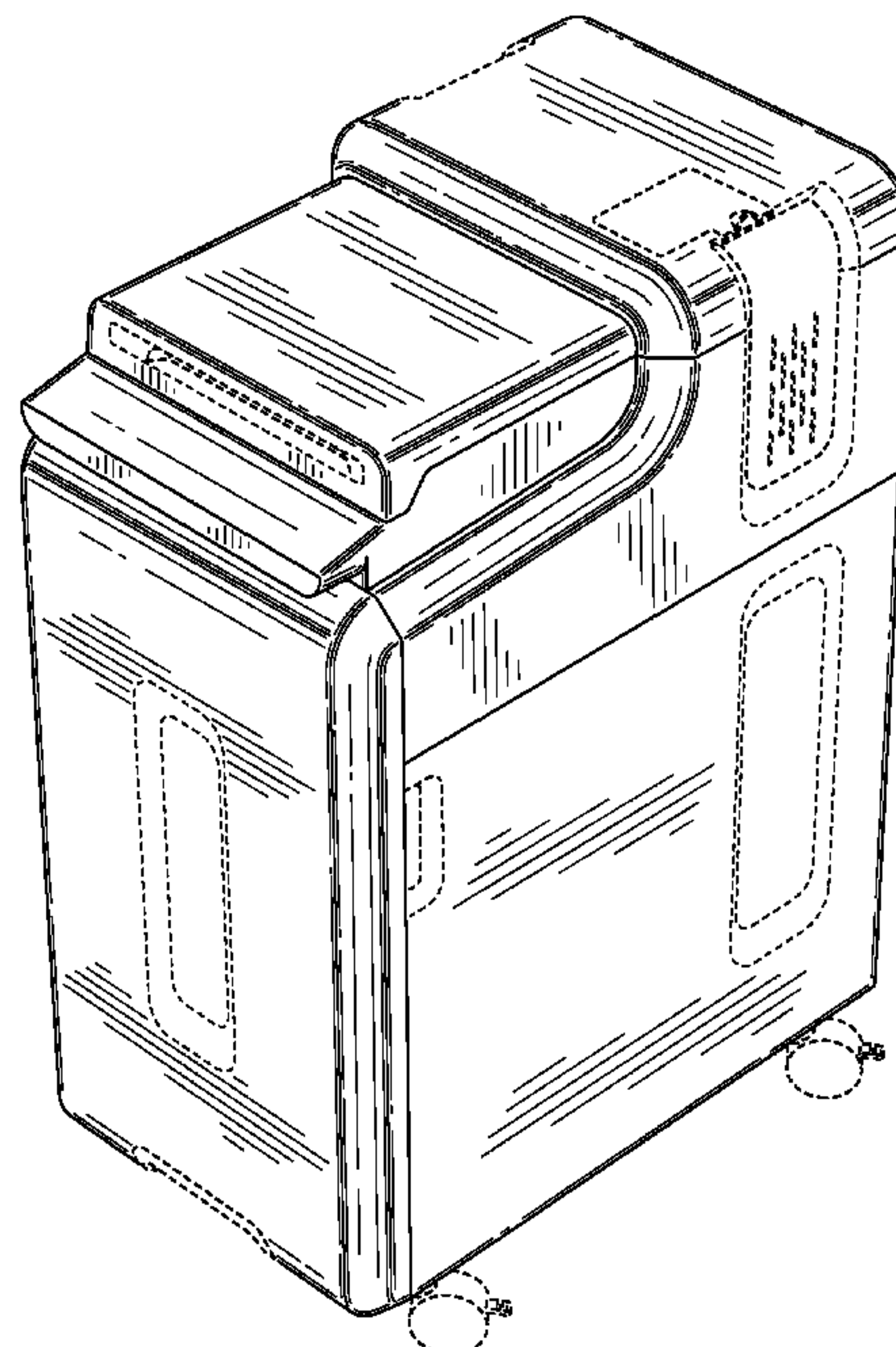
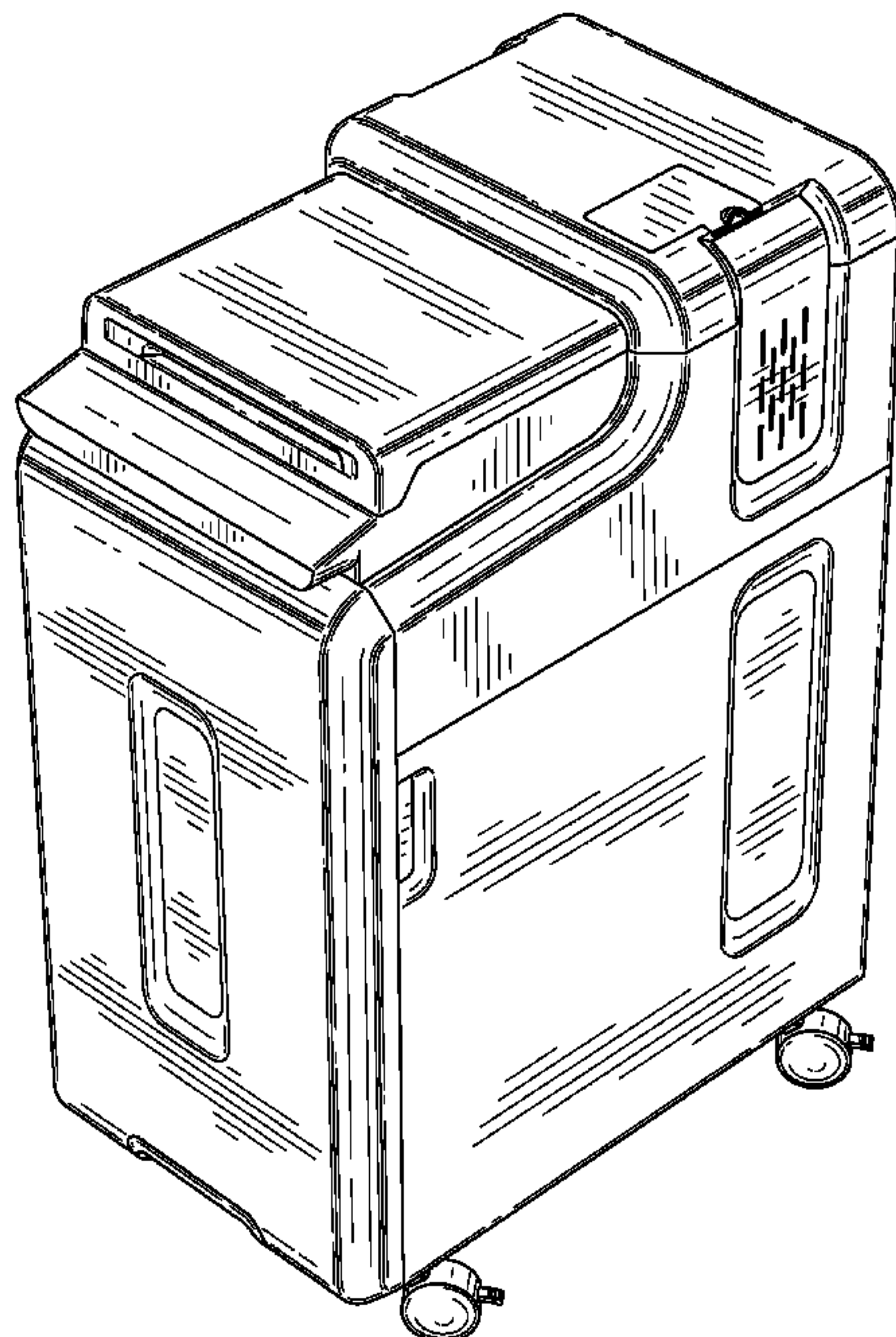

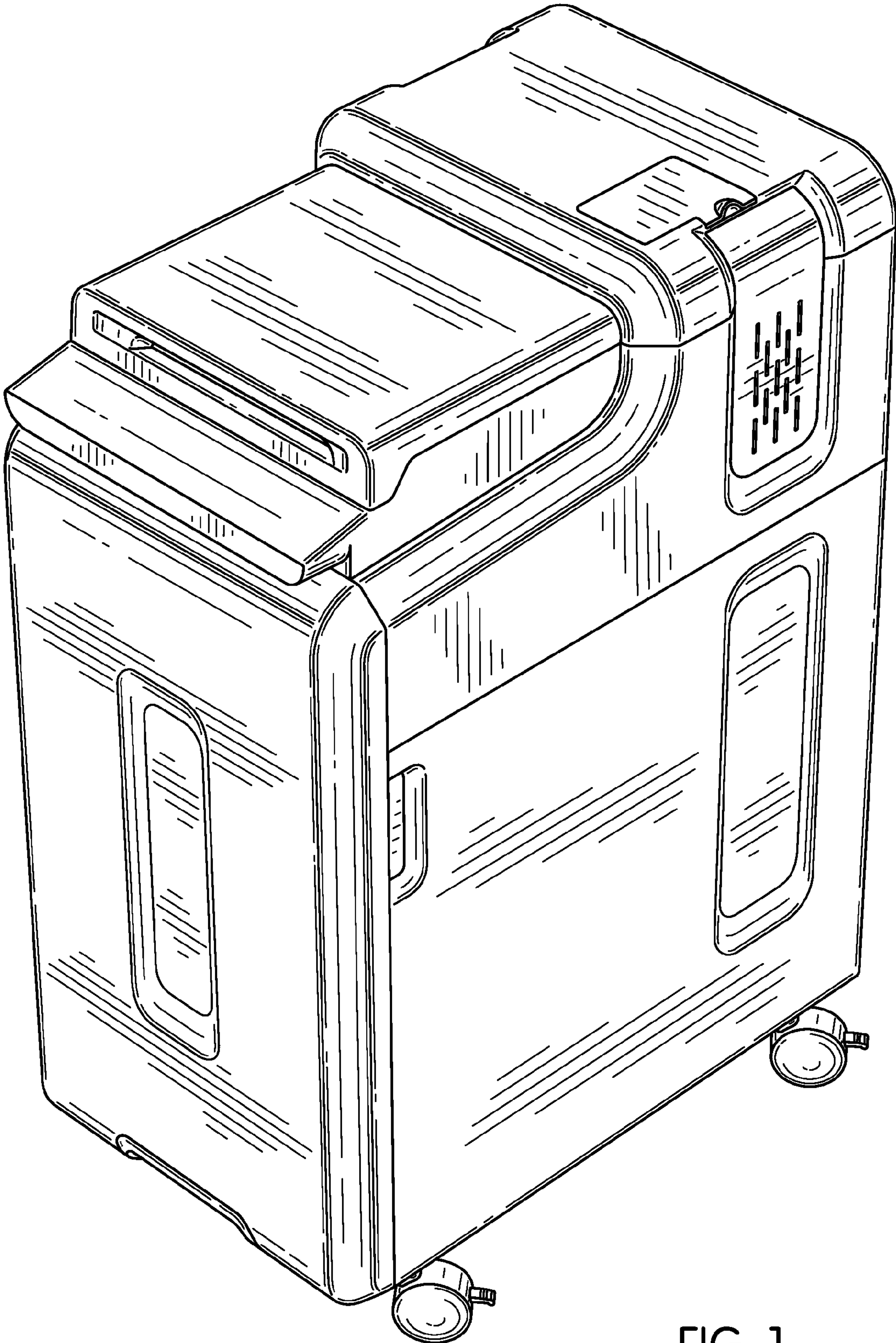

FIG. 1

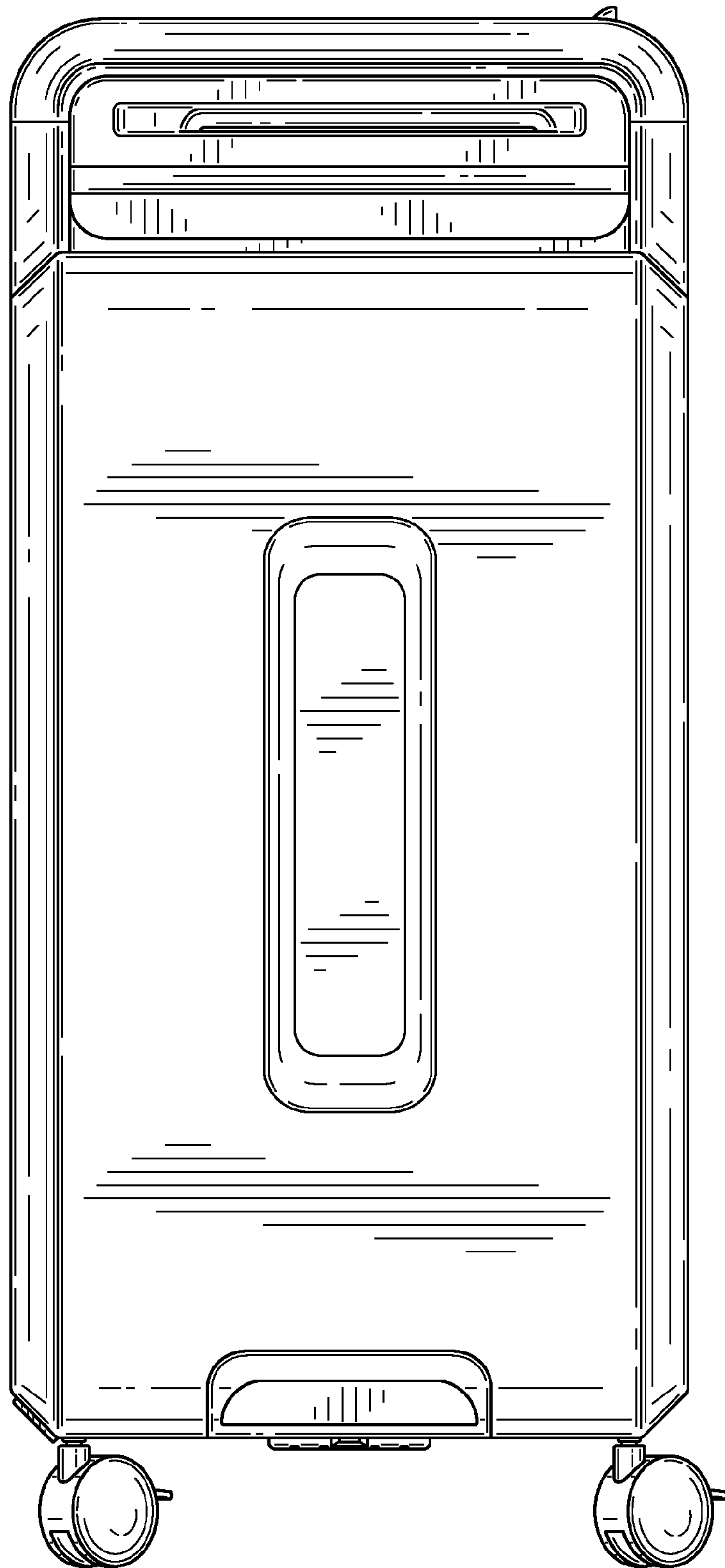

FIG. 2

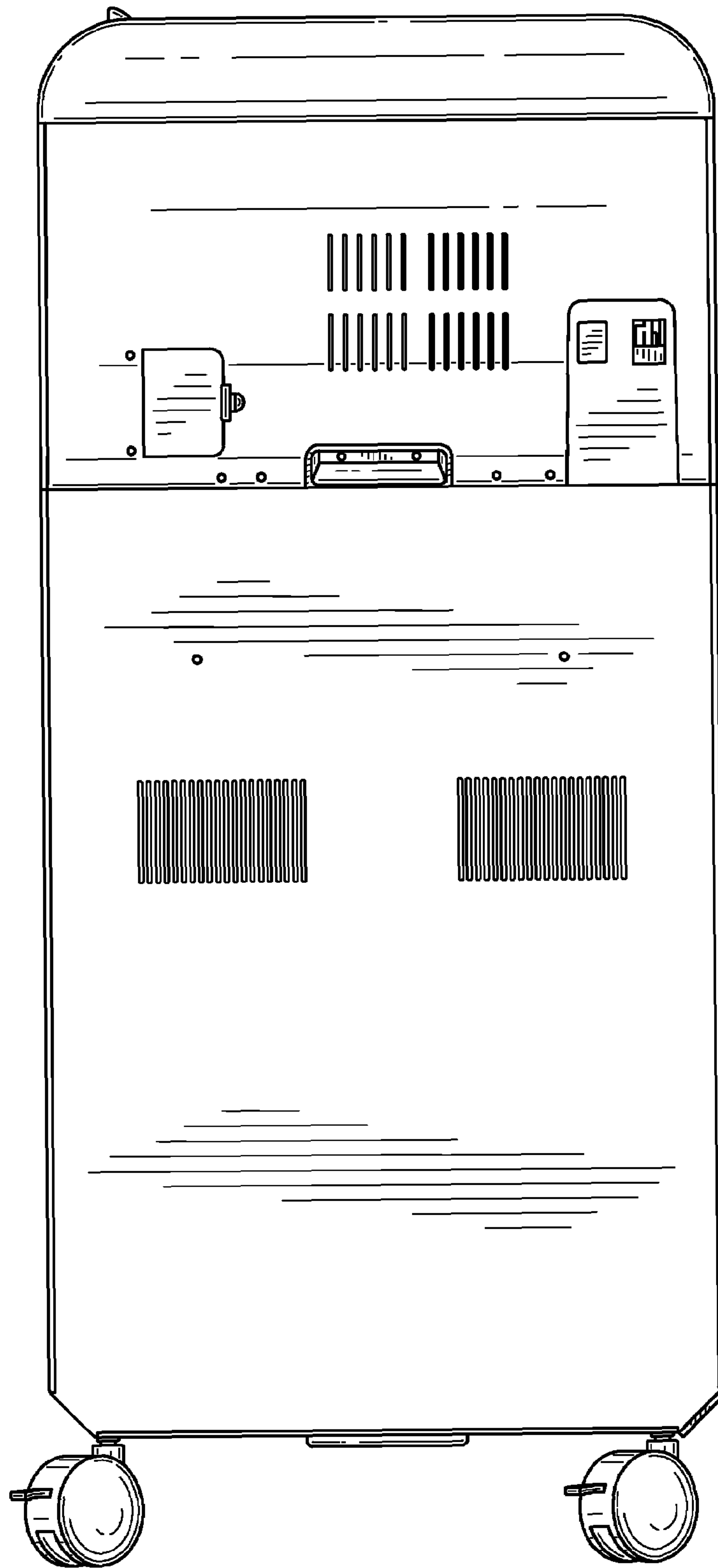

FIG. 3

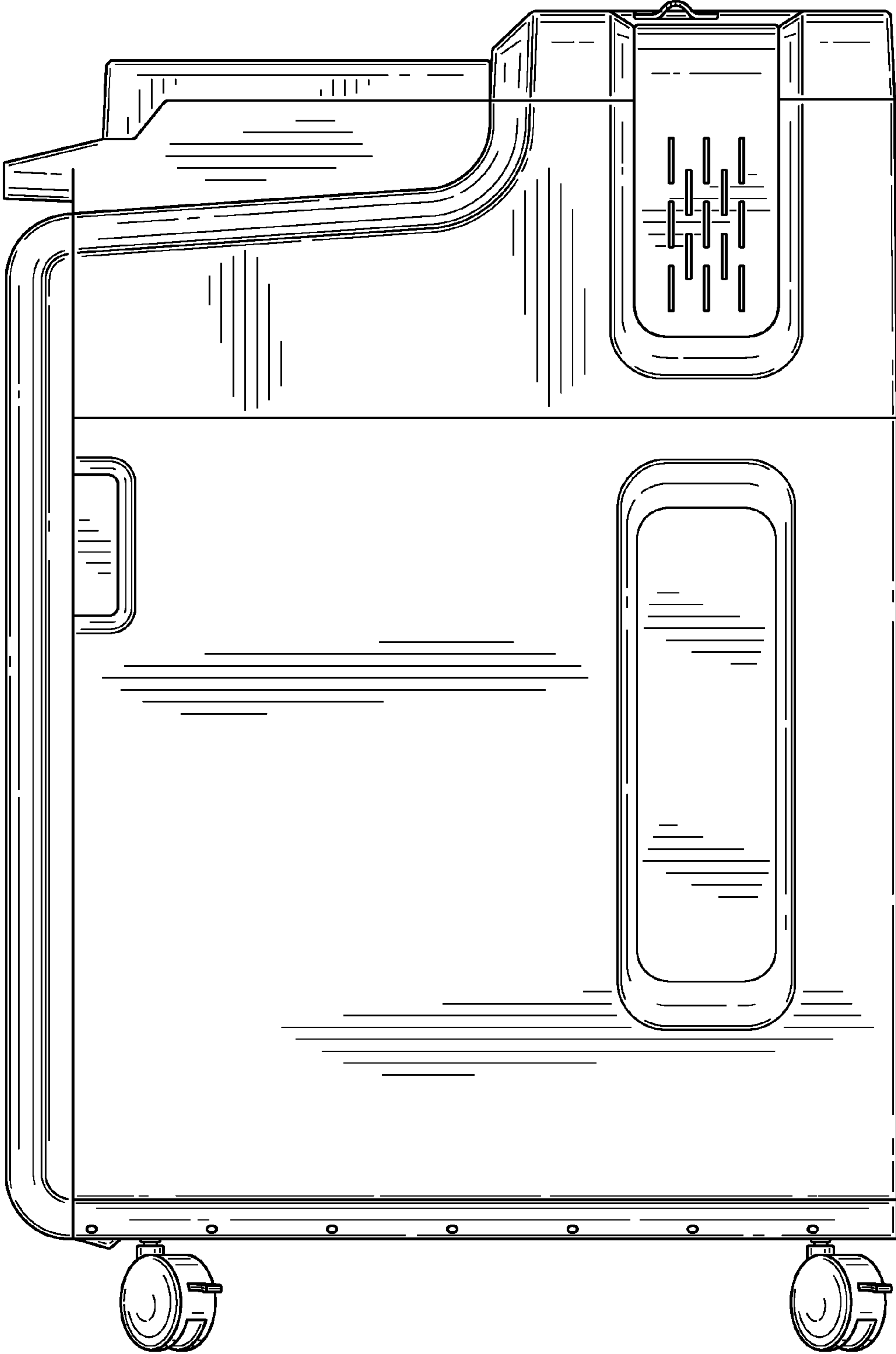

FIG. 4

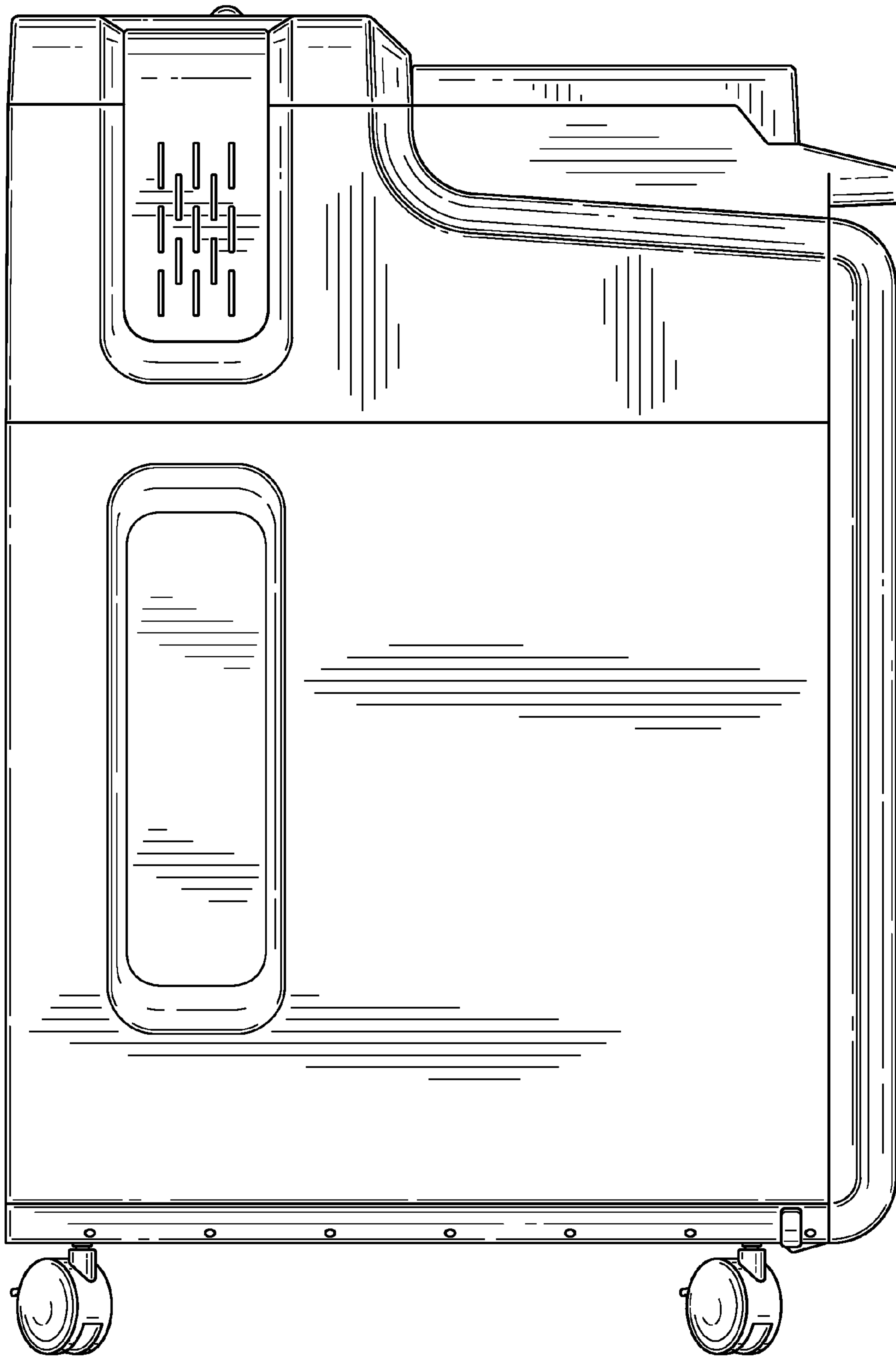

FIG. 5

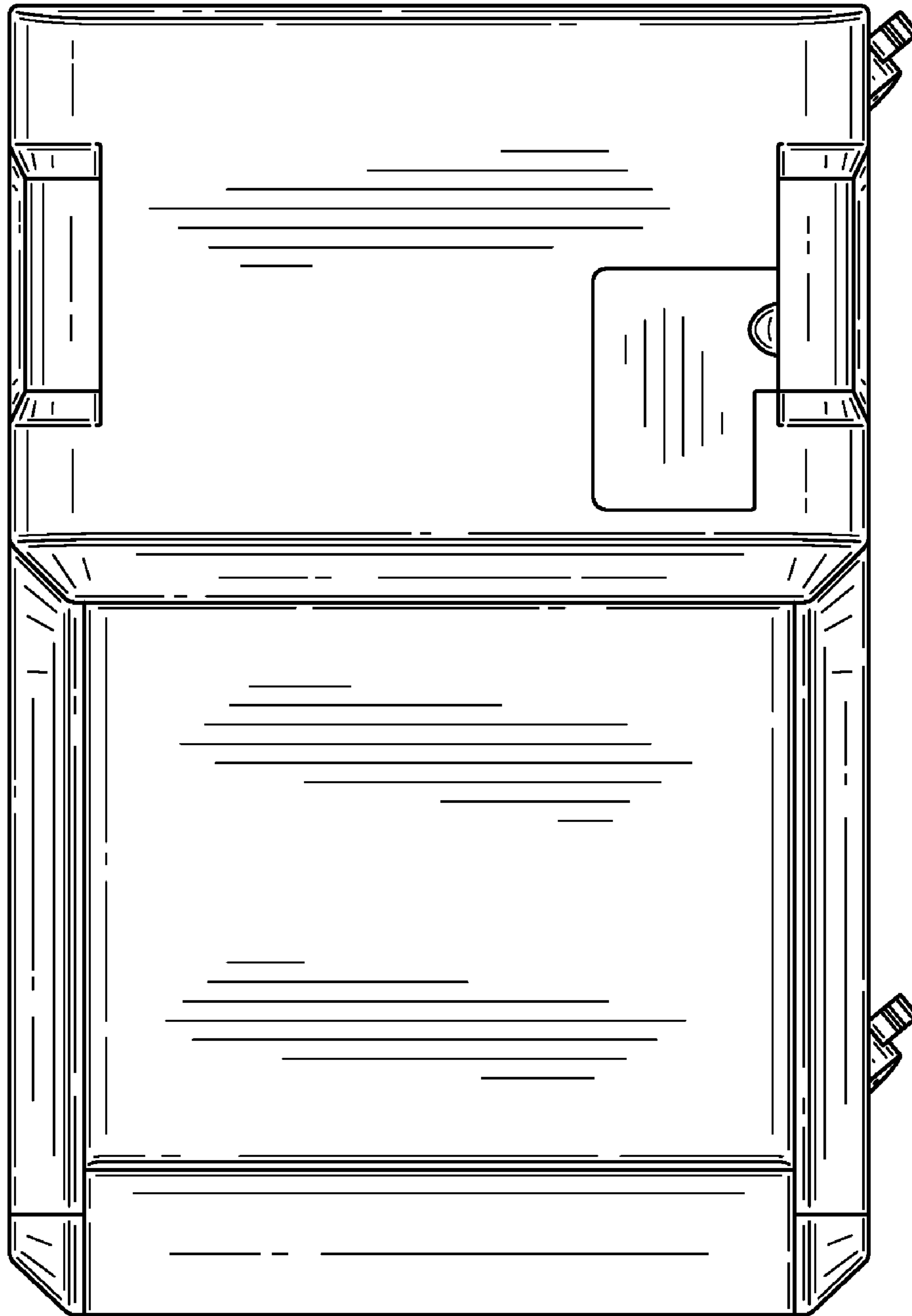

FIG. 6

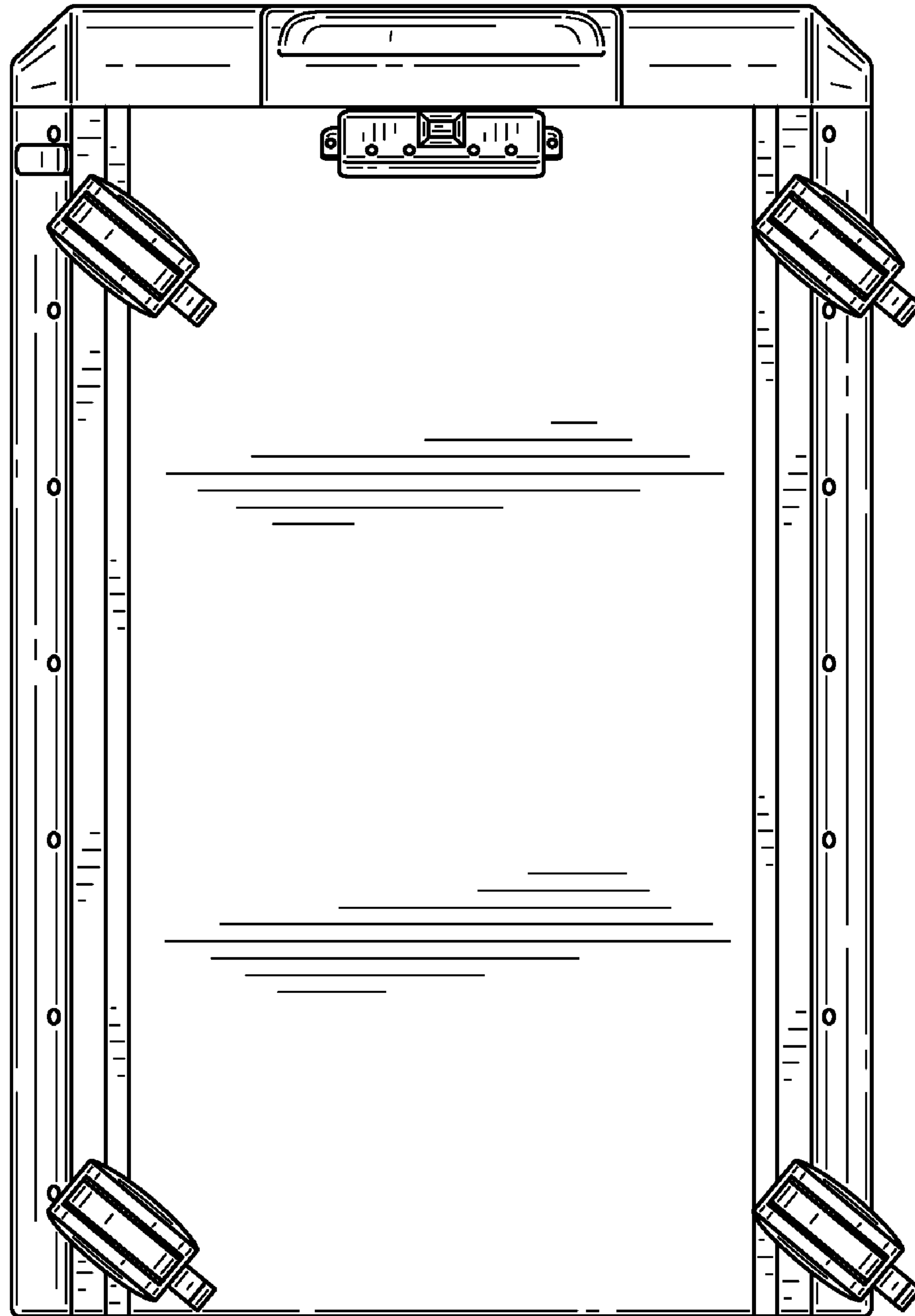

FIG. 7

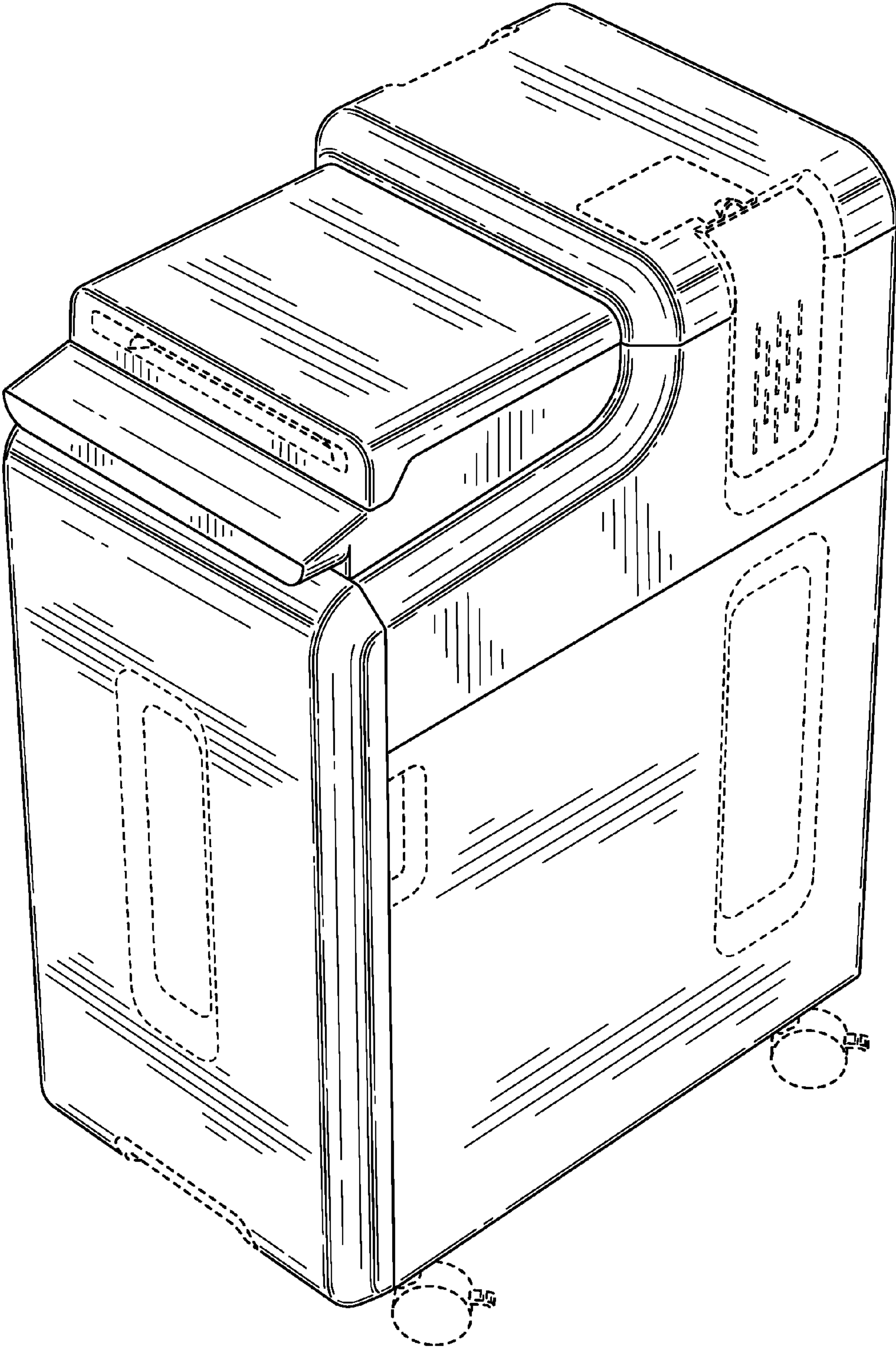

FIG. 8

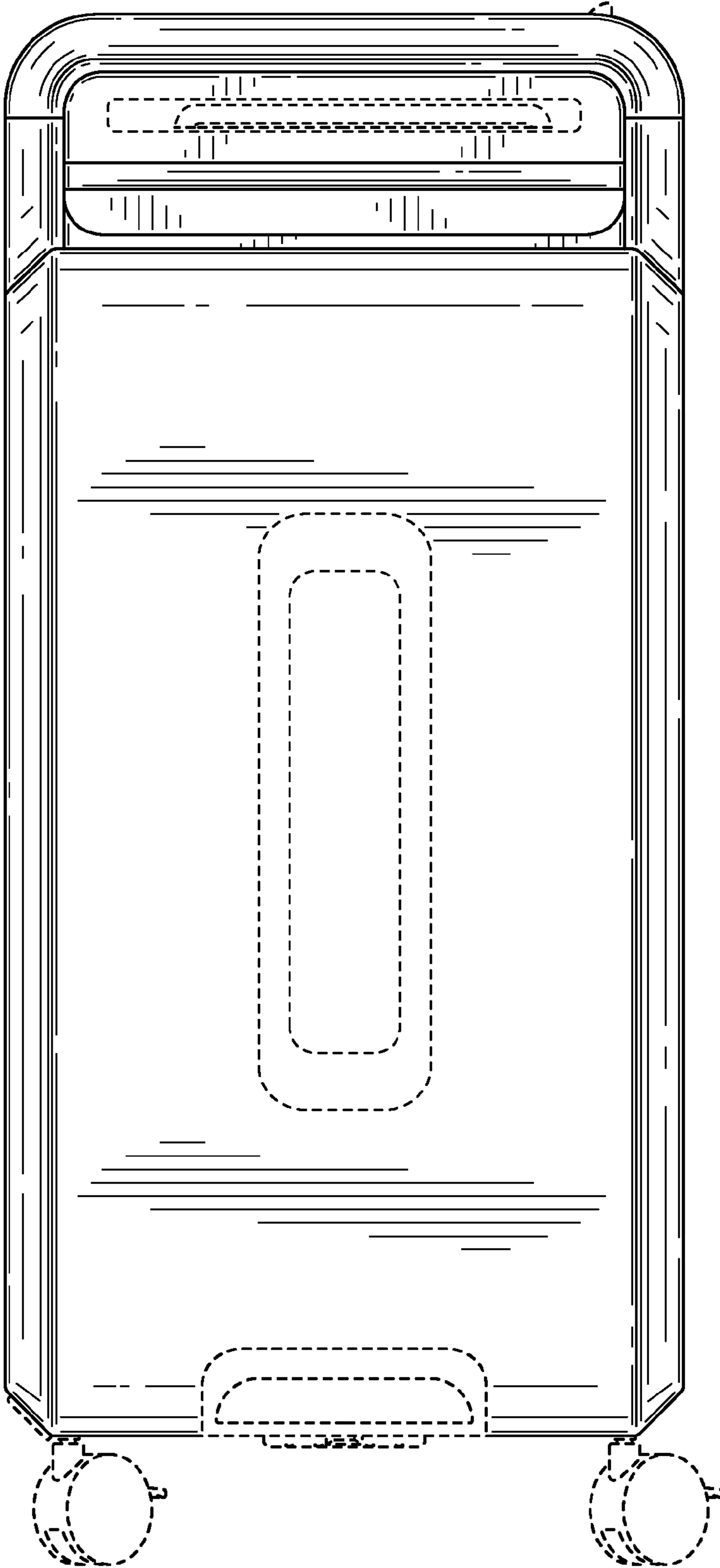

FIG. 9

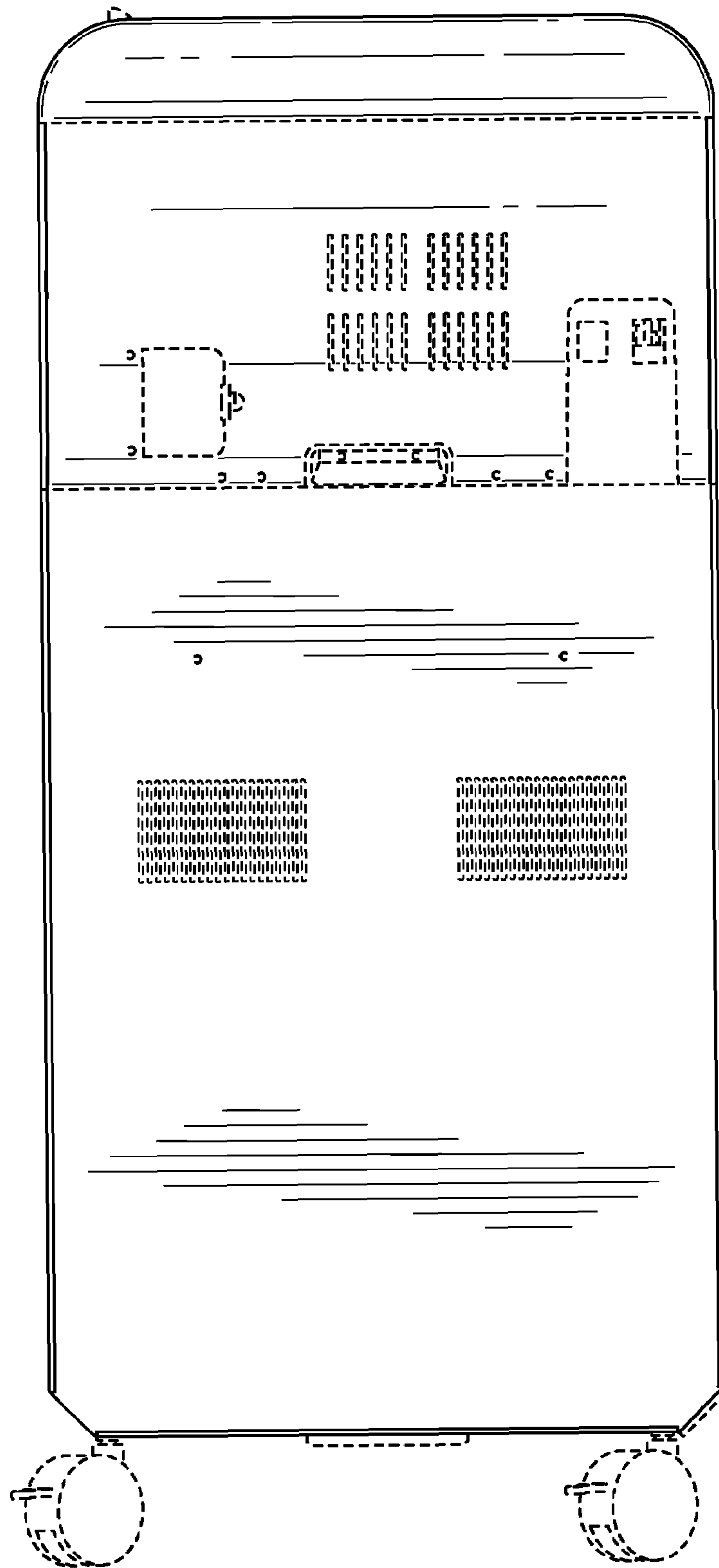

FIG. 10

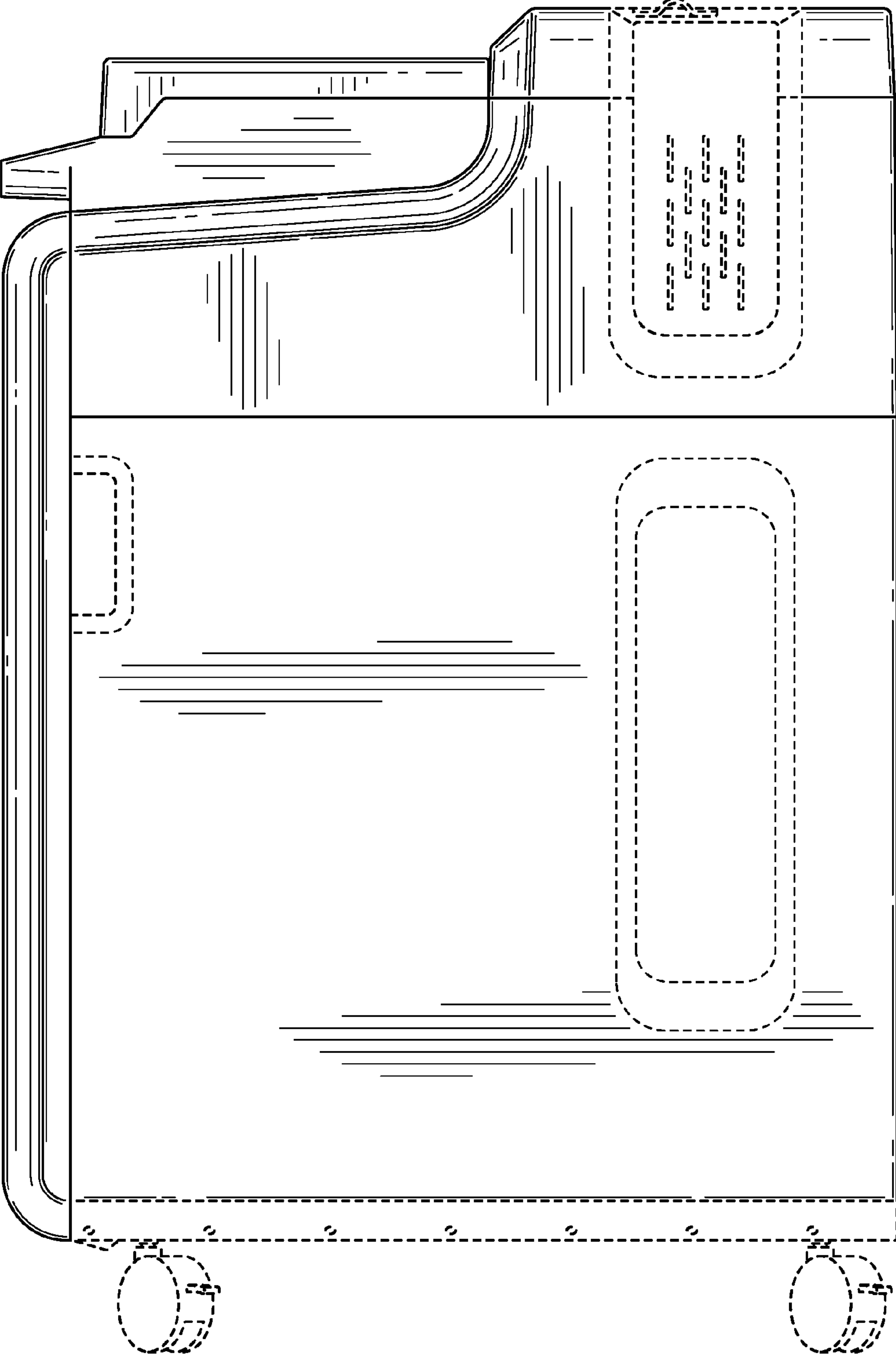

FIG. 11

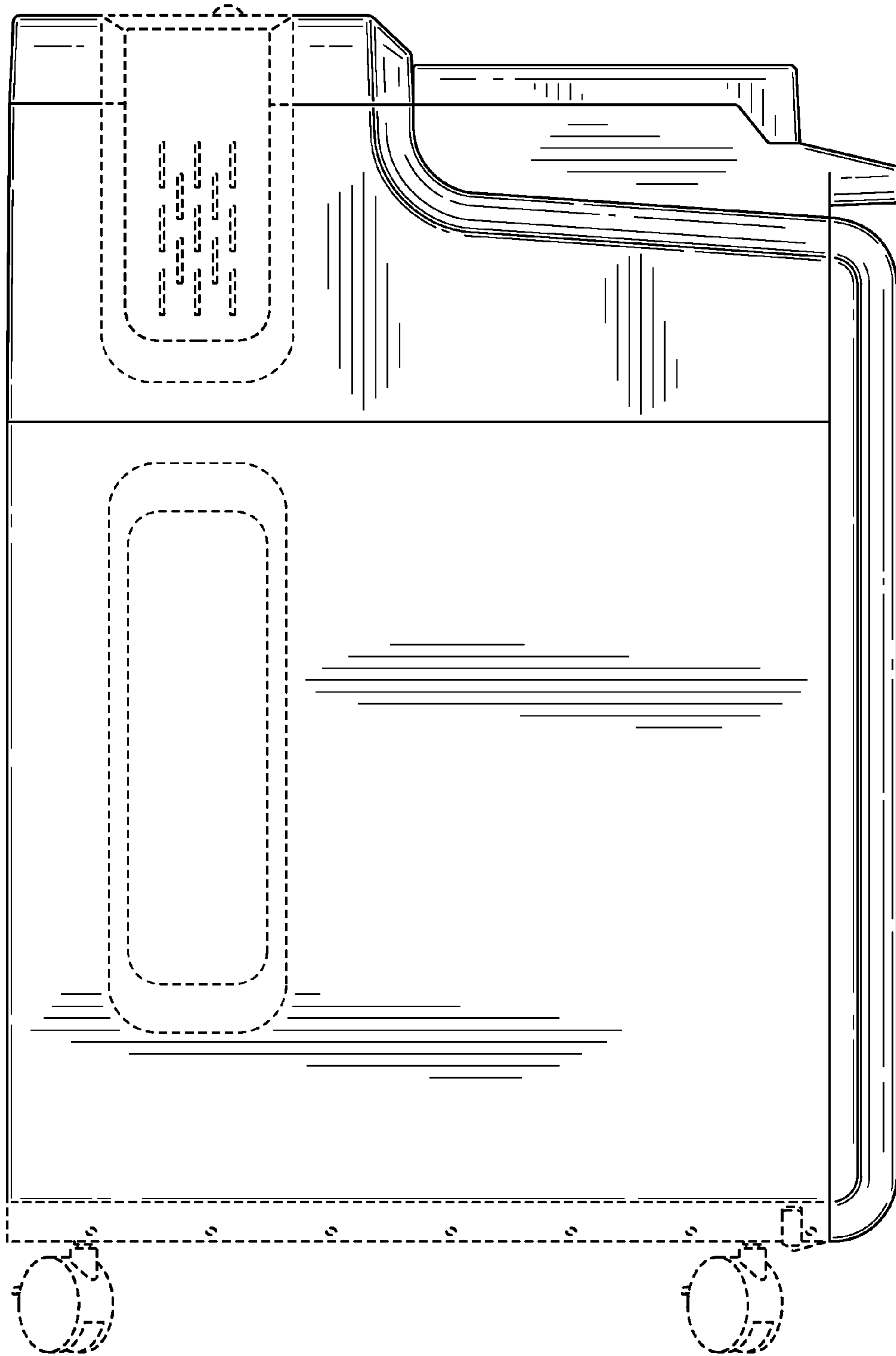

FIG. 12

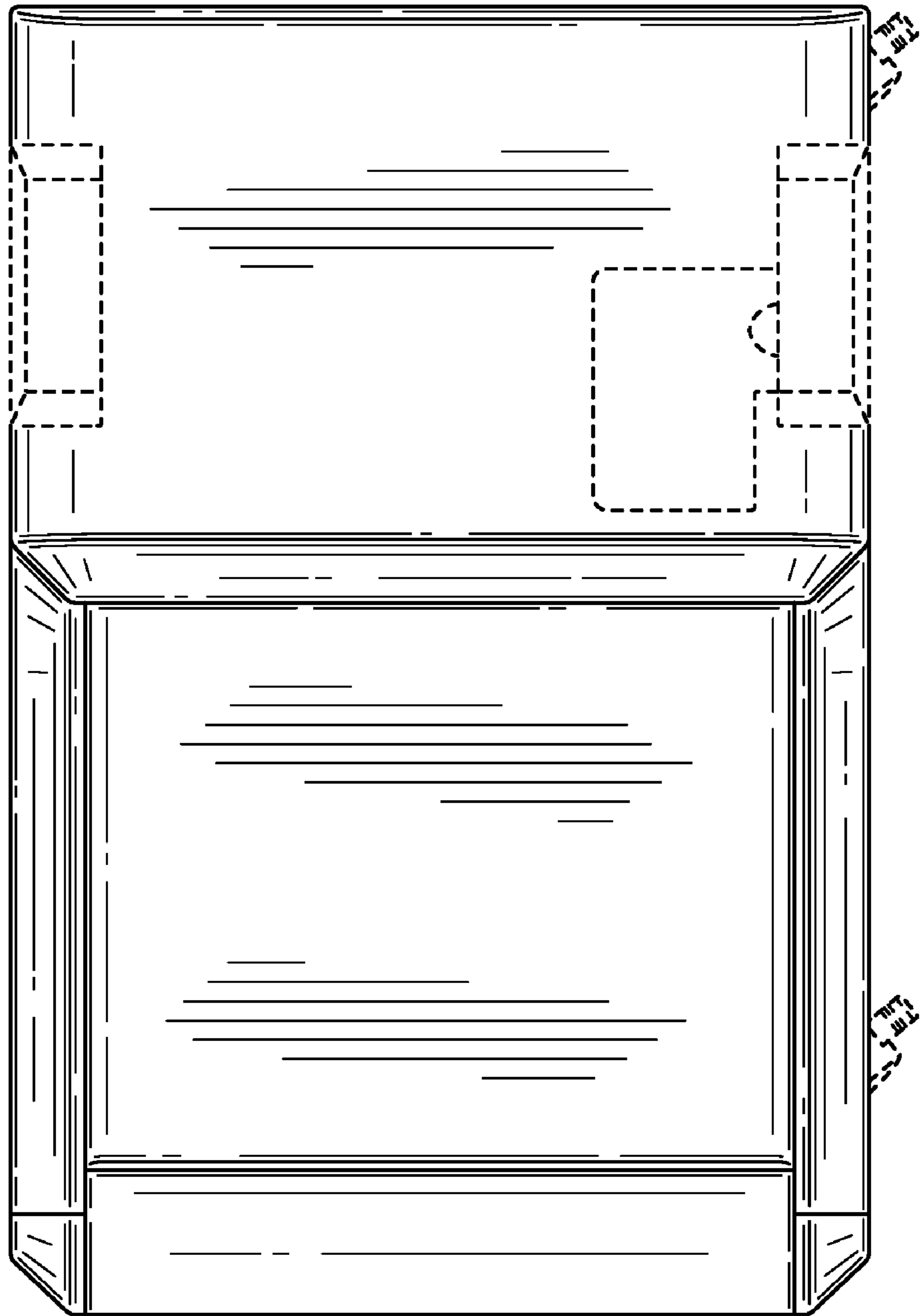

FIG. 13

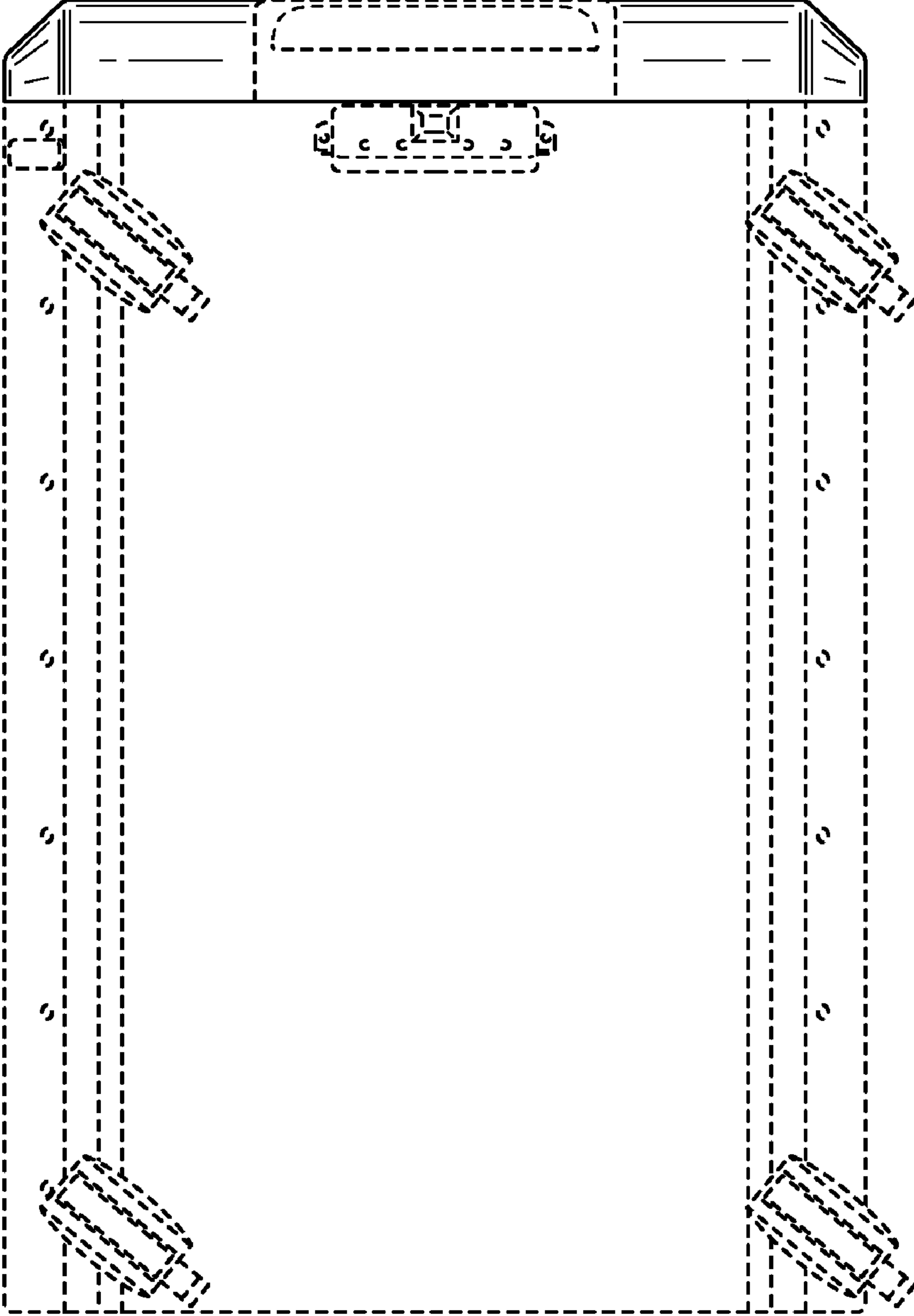

FIG. 14