



US00D616879S

(12) **United States Design Patent**
Kim et al.

(10) **Patent No.:** **US D616,879 S**
(45) **Date of Patent:** **** Jun. 1, 2010**

(54) **MOBILE PHONE COVER**

D548,732 S * 8/2007 Cebe et al. D14/341
D558,179 S * 12/2007 Hansen D14/138 AA

(75) Inventors: **Yun-Su Kim**, Seoul (KR); **Sang-Min Hyun**, Seoul (KR); **Seog-Guen Kim**, Seoul (KR)

(Continued)

(73) Assignee: **Samsung Electronics Co., Ltd.**, Suwon-Si (KR)

OTHER PUBLICATIONS

(**) Term: **14 Years**

Diamond Case for Samsung M800/Diamond Faceplate for Samsung Instinct M800, <URL:http://www.alibaba.com/product-gs/265153504/diamond_case_for_samsung_M800_diamond.html>, retrieved from internet Jan. 10, 2010.*

(21) Appl. No.: **29/340,918**

(Continued)

(22) Filed: **Jul. 28, 2009**

Primary Examiner—Robert M Spear
Assistant Examiner—Carla Jobe Wright

(30) **Foreign Application Priority Data**

(74) *Attorney, Agent, or Firm*—Staas & Halsey LLP

Apr. 8, 2009 (KR) 30-2009-0014752

(57) **CLAIM**

(51) **LOC (9) Cl.** **14-03**

The ornamental design for a mobile phone cover, as shown and described.

(52) **U.S. Cl.** **D14/250; D14/248**

(58) **Field of Classification Search** D14/138 AA, D14/138 AD, 138 G, 140, 142, 167, 217, D14/218, 240, 242, 248, 250–253, 299, 341–347, D14/440, 203.1–203.8; D3/200–201, 218–219, D3/228, 269, 301, 273; D13/103, 107–108, D13/119; 220/4.02; 224/191, 240, 241, 224/245, 682–683; 248/206.2–206.4, 220.21, 248/279.1, 309.1; 361/679.3, 679.56; 379/420.04, 379/426, 433.11, 446–447, 454, 455; 455/575.1, 455/575.6, 575.7, 575.8, 575.9; 190/100; 206/305, 320
See application file for complete search history.

DESCRIPTION

FIG. 1 is a front perspective view of a mobile phone cover; FIG. 2 is a front view of the mobile phone cover of FIG. 1; FIG. 3 is a rear view of the mobile phone cover of FIG. 1; FIG. 4 is a left-side view of the mobile phone cover of FIG. 1; FIG. 5 is a right-side view of the mobile phone cover of FIG. 1; FIG. 6 is a top plan view of the mobile phone cover of FIG. 1; FIG. 7 is a bottom plan view of the mobile phone cover of FIG. 1; and, FIG. 8 is a front perspective view of the mobile phone cover of FIG. 1 shown separated from the mobile phone.

(56) **References Cited**

U.S. PATENT DOCUMENTS

D514,079 S * 1/2006 Lai D14/138 AA
D543,541 S * 5/2007 Chung et al. D14/250
D545,800 S * 7/2007 Ou et al. D14/138 AA
D546,316 S * 7/2007 Wu et al. D14/138 AA
D548,717 S * 8/2007 Davis D14/138 AA

In the drawings, the broken lines depict unclaimed environment.

1 Claim, 5 Drawing Sheets

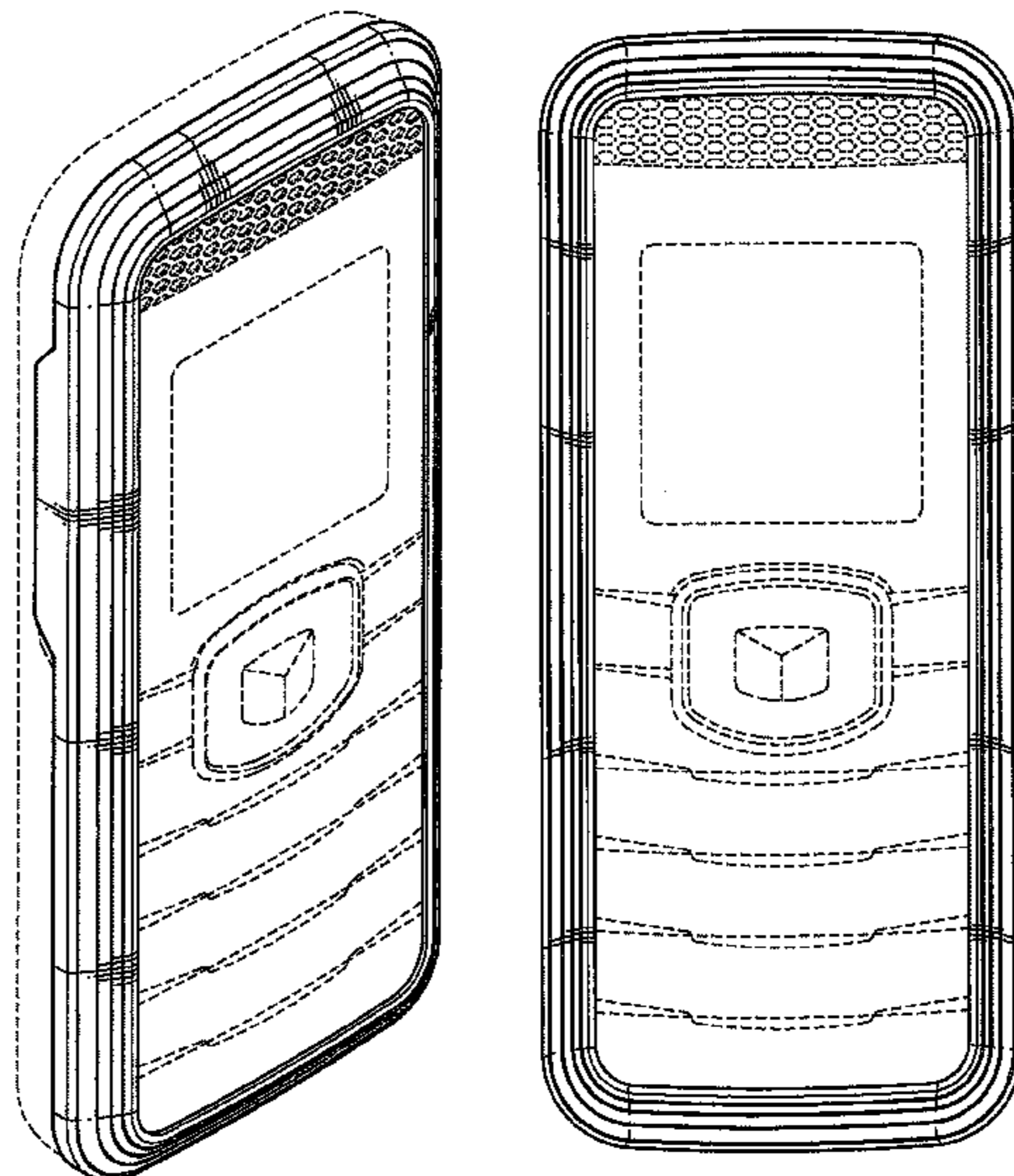

US D616,879 S

Page 2

U.S. PATENT DOCUMENTS

D562,300 S * 2/2008 Marry et al. D14/138 AA
D562,314 S * 2/2008 Han et al. D14/248
D569,862 S * 5/2008 Mitchell et al. D14/248
D570,834 S * 6/2008 Cobb D14/248
D586,342 S * 2/2009 Stone D14/248
D586,800 S * 2/2009 Andre et al. D14/341
D589,948 S * 4/2009 Shi D14/248
D589,953 S * 4/2009 Turner D14/248
D591,279 S * 4/2009 Liu D14/248
D591,704 S * 5/2009 Shi D14/138 AA
D596,153 S * 7/2009 Turner D14/138 AA
D597,989 S * 8/2009 Holtorf et al. D14/138 AA

D598,414 S * 8/2009 Joung et al. D14/138 G
D598,419 S * 8/2009 Shi D14/138 AA
D606,062 S * 12/2009 Stone et al. D14/248
D606,063 S * 12/2009 Chen et al. D14/248
D606,527 S * 12/2009 Chen et al. D14/248
2006/0111052 A1* 5/2006 Gartrell 455/90.3

OTHER PUBLICATIONS

Cell Phone Case/Cellular Phone Case/Mobile Phone Case,
<URL:[http://www.alibaba.com/product-gs/265153504/
diamond_case_for_samsung_M800_diamond.html](http://www.alibaba.com/product-gs/265153504/diamond_case_for_samsung_M800_diamond.html)>, retrieved
from internet Jan. 10, 2010.*

* cited by examiner

FIG. 1

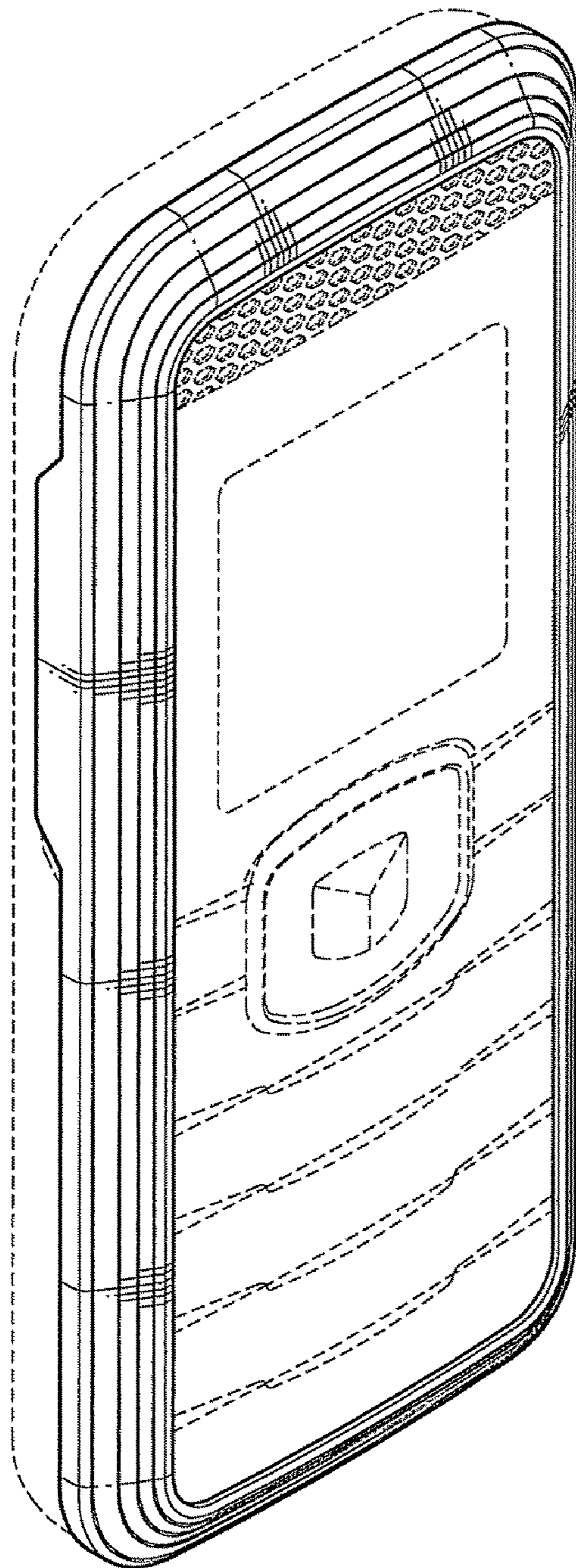

FIG. 2

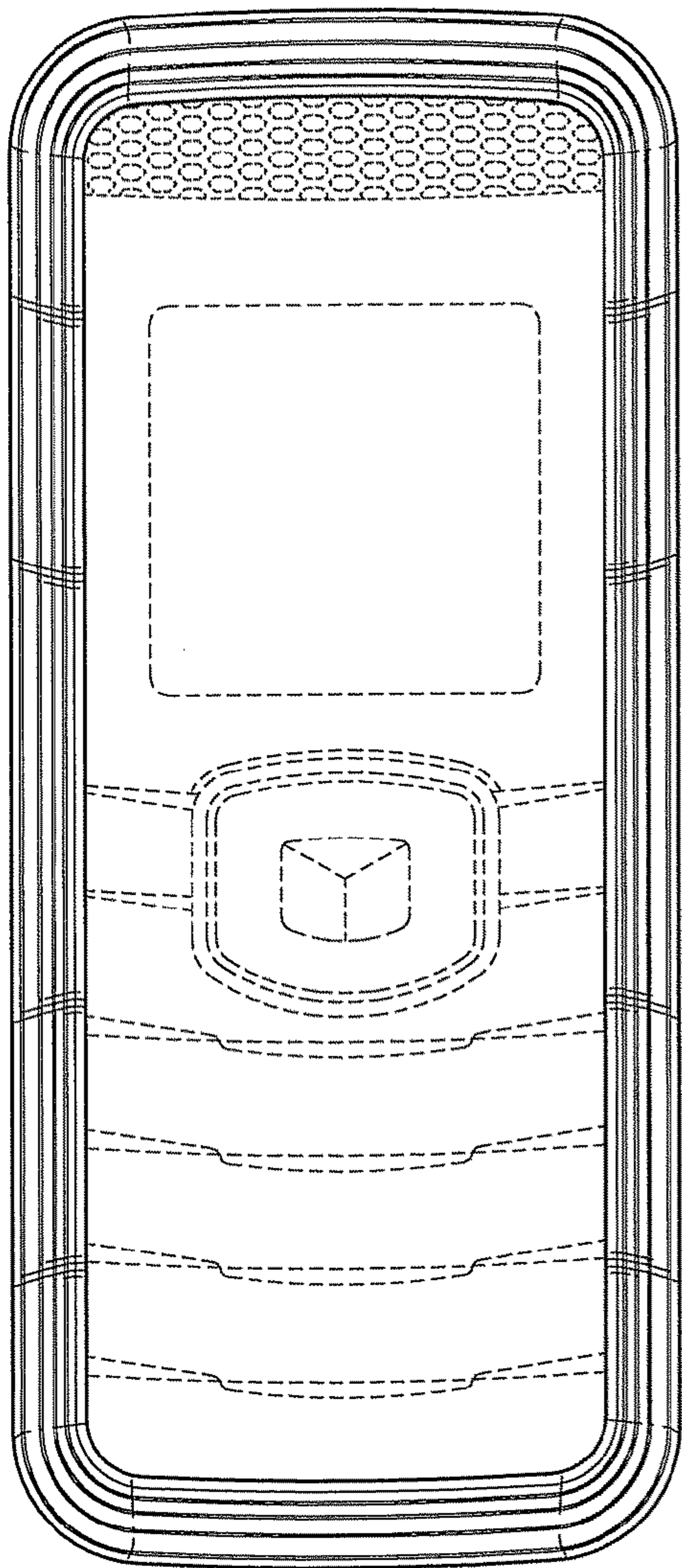

FIG. 3

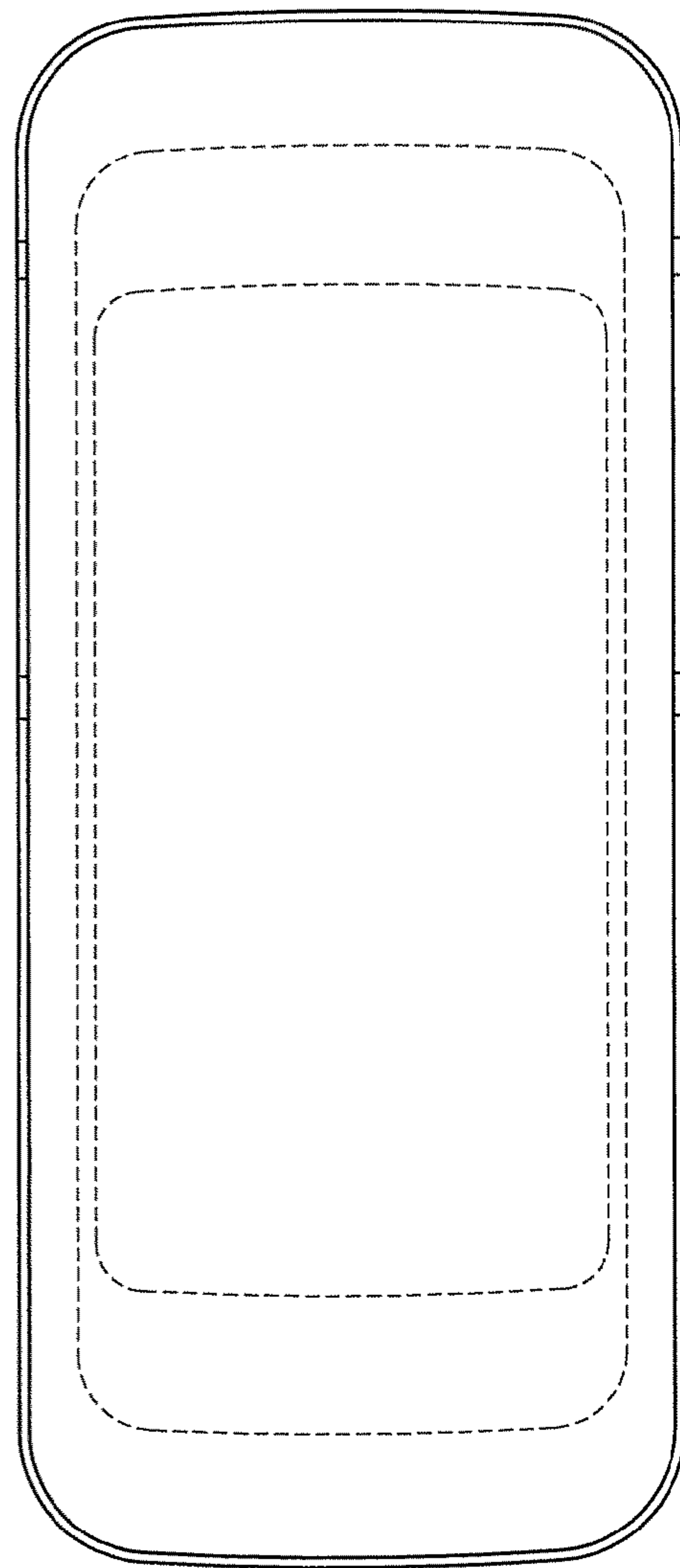

FIG. 4

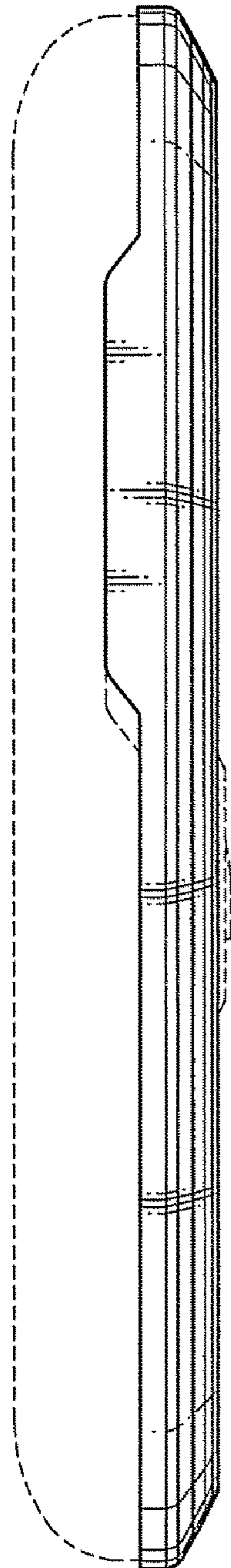

FIG. 5

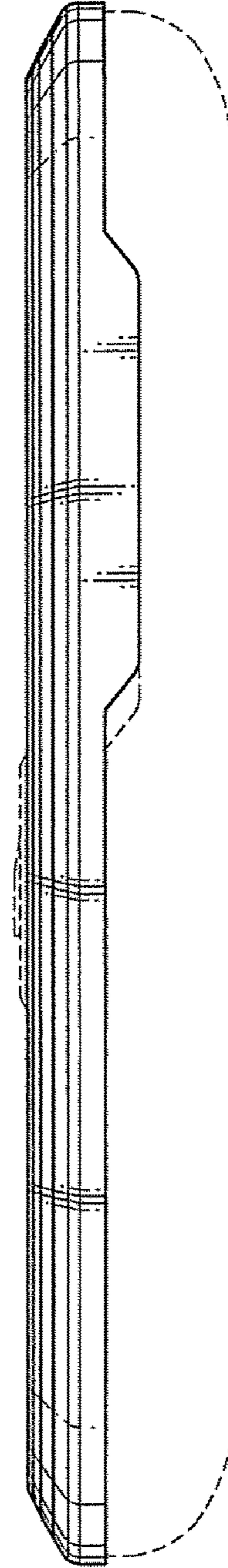

FIG. 6

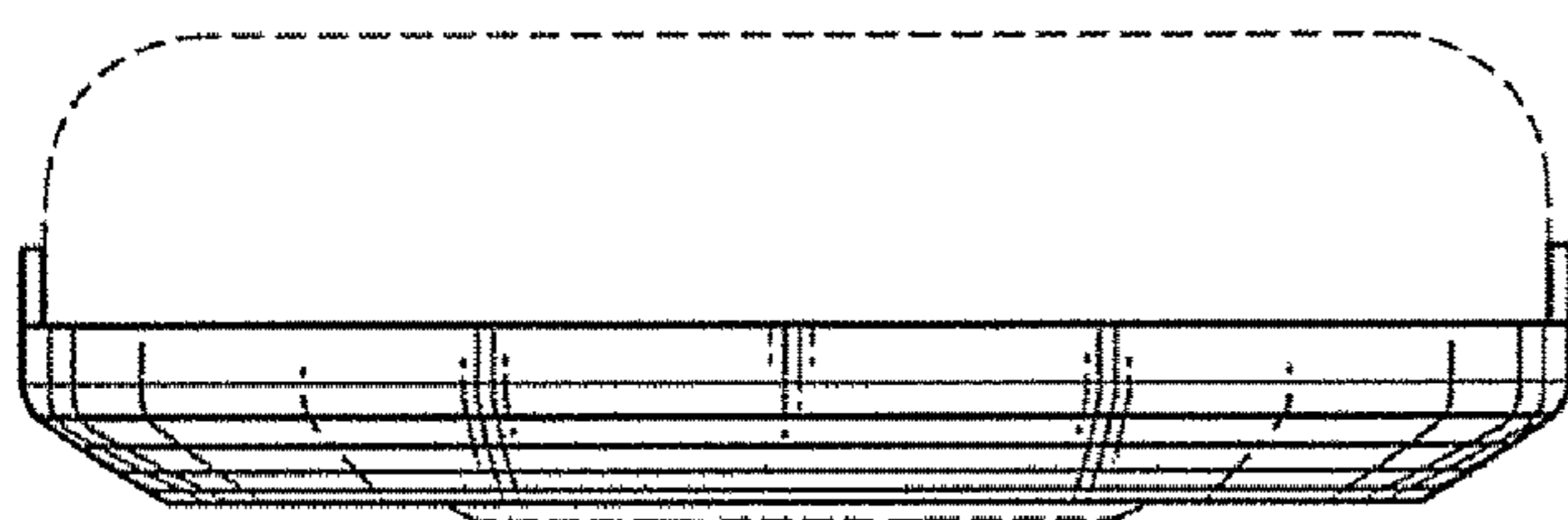

FIG. 7

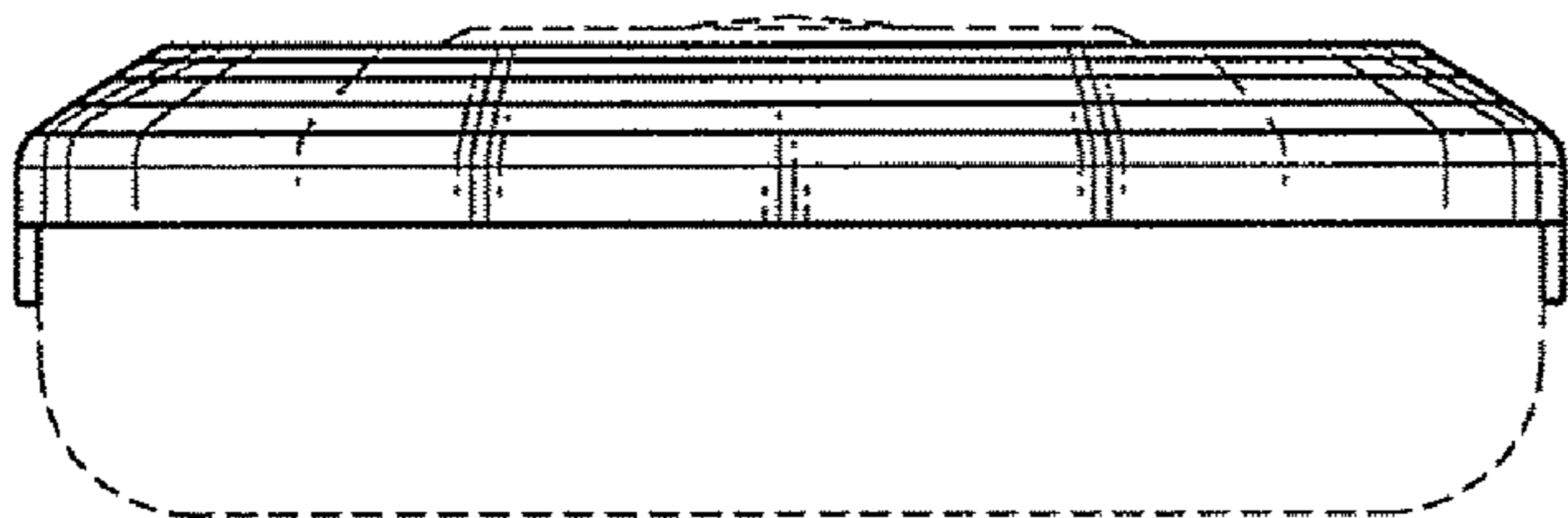

FIG. 8

