



US00D616839S

(12) **United States Design Patent**
Edmond et al.

(10) **Patent No.:** **US D616,839 S**
(45) **Date of Patent:** **** Jun. 1, 2010**

(54) **LED CHIP**

D582,866 S * 12/2008 Edmond et al. D13/180

(75) Inventors: **John Edmond**, Cary, NC (US); **David Beardsley Slater, Jr.**, Durham, NC (US); **Amber Christine Salter**, Durham, NC (US); **Ashay Chitnis**, Goleta, CA (US); **James Ibbetson**, Santa Barbara, CA (US); **Bernd Peter Keller**, Santa Barbara, CA (US)

(Continued)

OTHER PUBLICATIONS

Lumileds LED Die; Philips/Lumileds Light from Silicon Valley "LED Die," pp. 1-2, <<http://www.lumileds.com/products/line.cm?lineid=16>> (2006).

(Continued)

(73) Assignee: **Cree, Inc.**, Durham, NC (US)

Primary Examiner—Selina Sikder

(**) Term: **14 Years**

(74) *Attorney, Agent, or Firm*—Myers Bigel Sibley & Sajovec

(21) Appl. No.: **29/327,793**

(57) **CLAIM**

(22) Filed: **Nov. 13, 2008**

The ornamental design for an LED chip, as shown and described.

Related U.S. Application Data

DESCRIPTION

(62) Division of application No. 29/280,949, filed on Jun. 11, 2007, now Pat. No. Des. 582,865.

FIG. 1 is a top perspective view of another embodiment of the LED chip showing our design;

(51) **LOC (9) Cl.** **13-03**

FIG. 2 is a top view thereof;

(52) **U.S. Cl.** **D13/180**

FIG. 3 is a first side view thereof;

(58) **Field of Classification Search** D13/180;

FIG. 4 is a bottom view thereof;

D26/2; 257/79, 80, 81, 88, 89, 95, 98, 99, 257/100; 313/483, 498, 500; 362/555, 800

FIG. 5 is a second different side view thereof;

See application file for complete search history.

FIG. 6 is an end view thereof;

(56) **References Cited**

FIG. 7 is an opposing end view thereof;

U.S. PATENT DOCUMENTS

FIG. 8 is a top perspective view of another embodiment of the LED chip showing our design;

6,097,040 A 8/2000 Morimoto et al.

FIG. 9 is a top view thereof;

6,255,129 B1 7/2001 Lin

FIG. 10 is a first side view thereof;

6,383,835 B1 * 5/2002 Hata et al. 438/65

FIG. 11 is a bottom view thereof;

6,498,592 B1 * 12/2002 Matthies 345/1.1

FIG. 12 is a second different side view thereof;

6,518,598 B1 2/2003 Chen

FIG. 13 is an end view thereof; and,

6,713,868 B2 * 3/2004 Ueno 257/730

FIG. 14 is an opposing end view thereof.

6,847,052 B2 1/2005 Fan et al.

The broken lines define portions of the LED chip that form no part of the claimed design.

6,870,519 B2 * 3/2005 Sundahl 345/1.3

7,289,089 B2 * 10/2007 Iwafuchi 345/82

D566,056 S * 4/2008 Edmond et al. D13/180

D566,057 S * 4/2008 Edmond et al. D13/180

D566,665 S * 4/2008 Liao et al. D13/180

D582,865 S * 12/2008 Edmond et al. D13/180

1 Claim, 4 Drawing Sheets

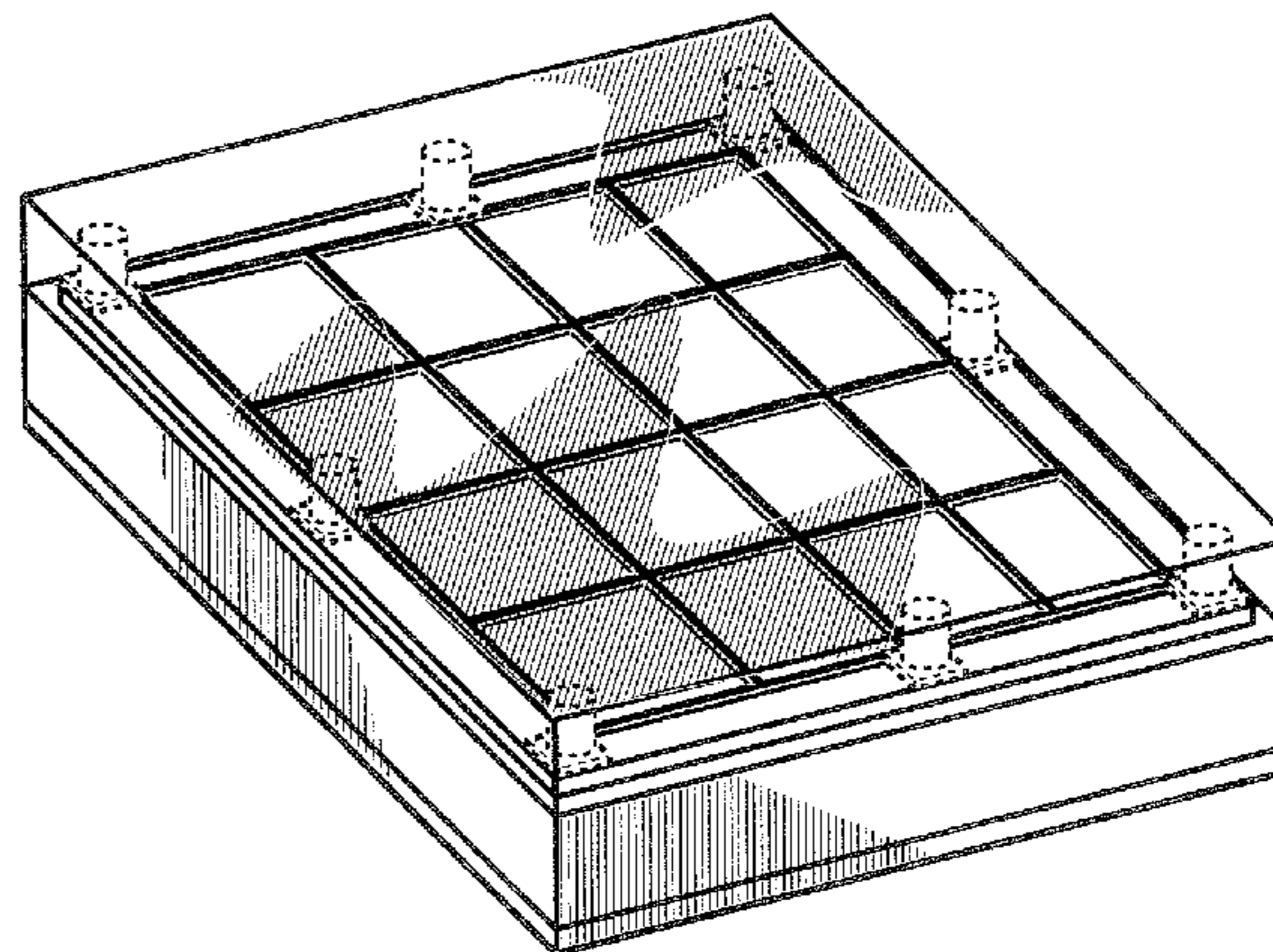
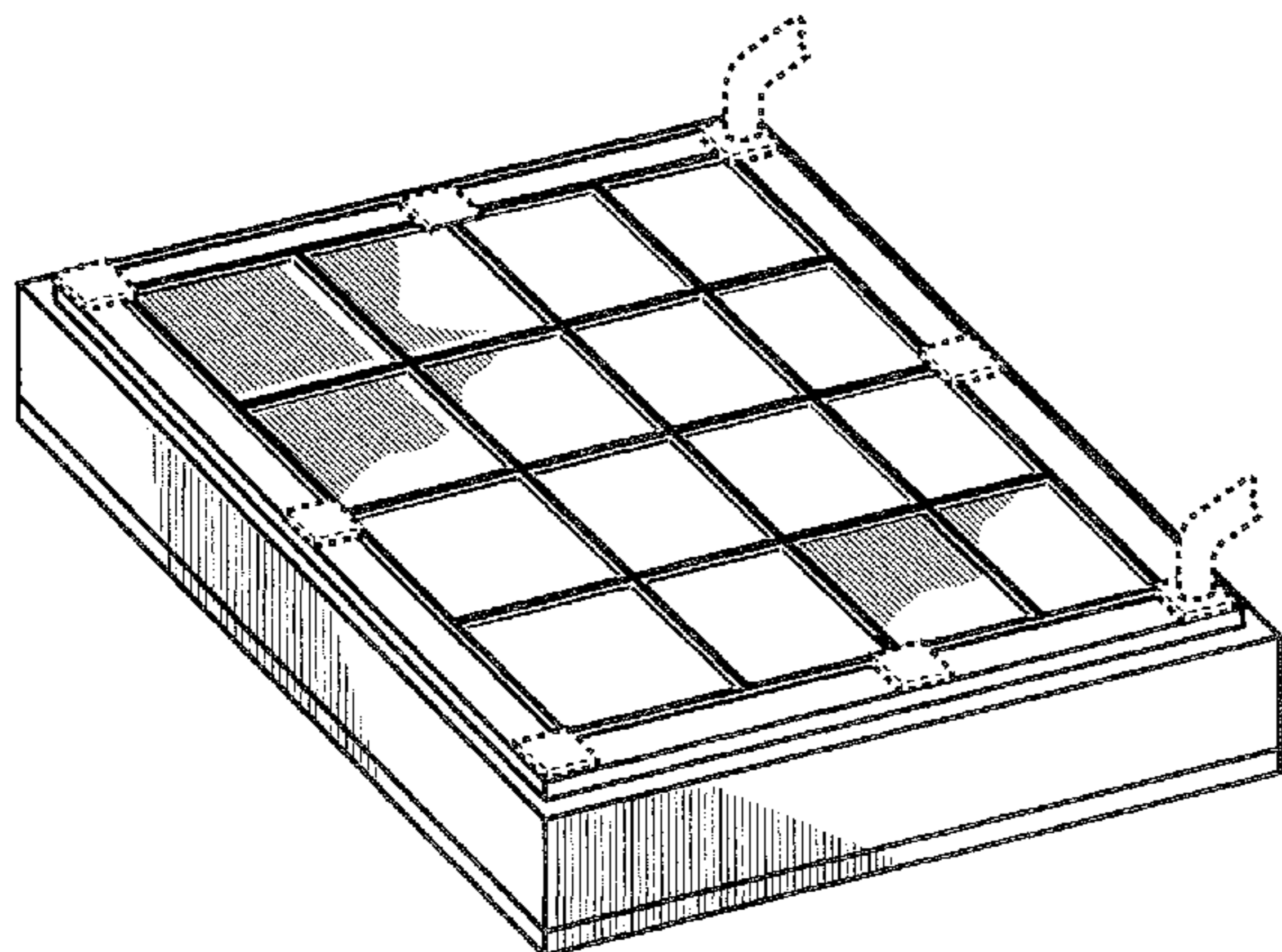

US D616,839 S

Page 2

U.S. PATENT DOCUMENTS

D583,338 S * 12/2008 Edmond et al. D13/180
2003/0222263 A1* 12/2003 Choi 257/79
2005/0023539 A1 2/2005 Fujiwara et al.
2005/0067624 A1 3/2005 Steigerwald et al.
2006/0049422 A1 3/2006 Shoji
2006/0131600 A1* 6/2006 Nakaoka et al. 257/99
2006/0151800 A1 7/2006 Keong et al.
2006/0226437 A1 10/2006 Fujita et al.
2007/0075323 A1* 4/2007 Kanazawa et al. 257/98
2007/0085089 A1 4/2007 Hsu

2007/0138585 A1 6/2007 Hsin et al.

OTHER PUBLICATIONS

Color photos Lumileds LEDs, 1 page, (for exam purposes, date is assumed to be before Dec. 21, 2006).

Image of Osram chip, 1 page, (prior to Dec. 29, 2005).

"Lumileds LED," 1 page, (Oct. 2-4, 2002).

SemiLEDS "Products", 2 pages, http://www.semileds.com/en_04product.asp (2006).

* cited by examiner

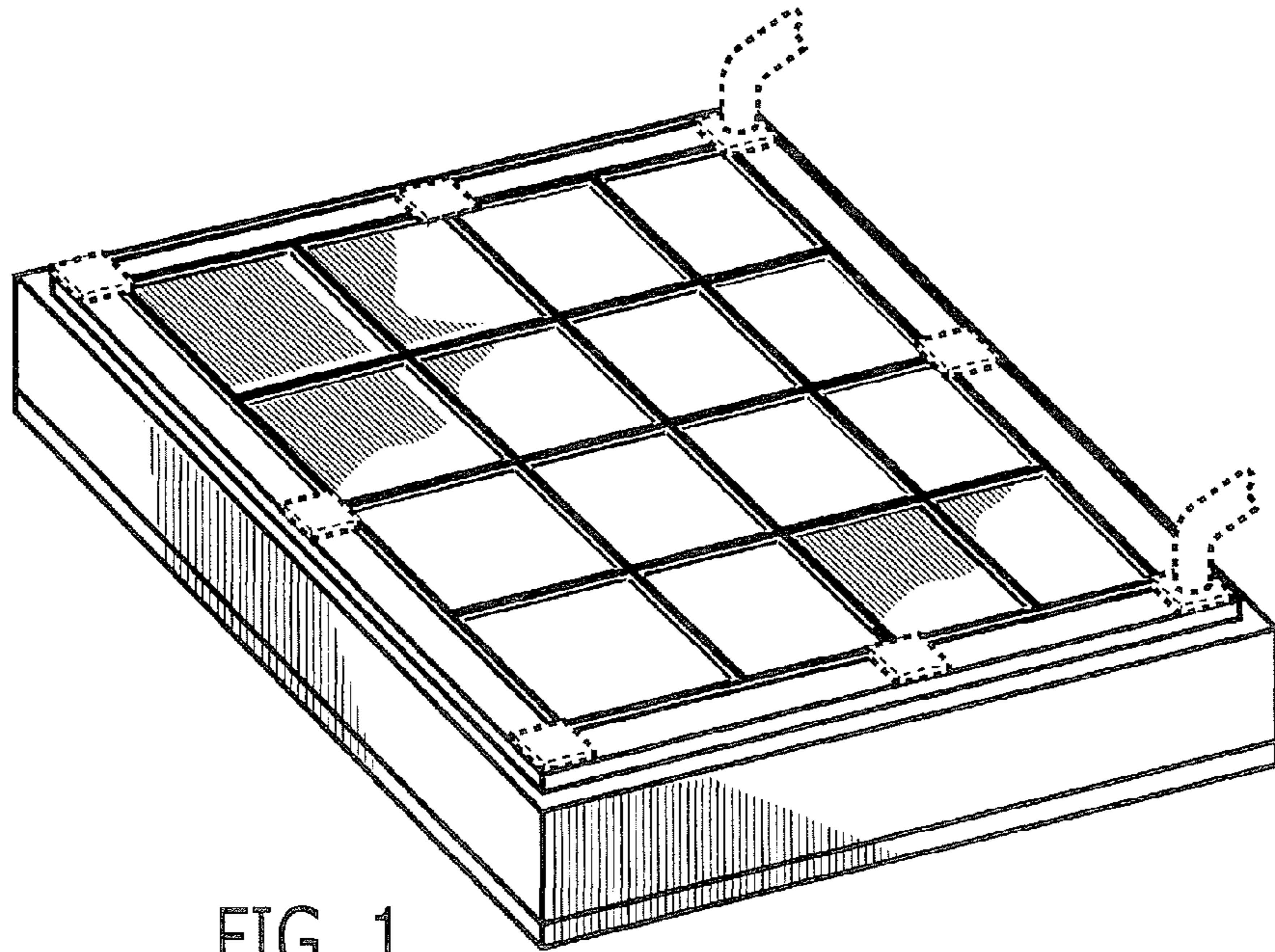

FIG. 1

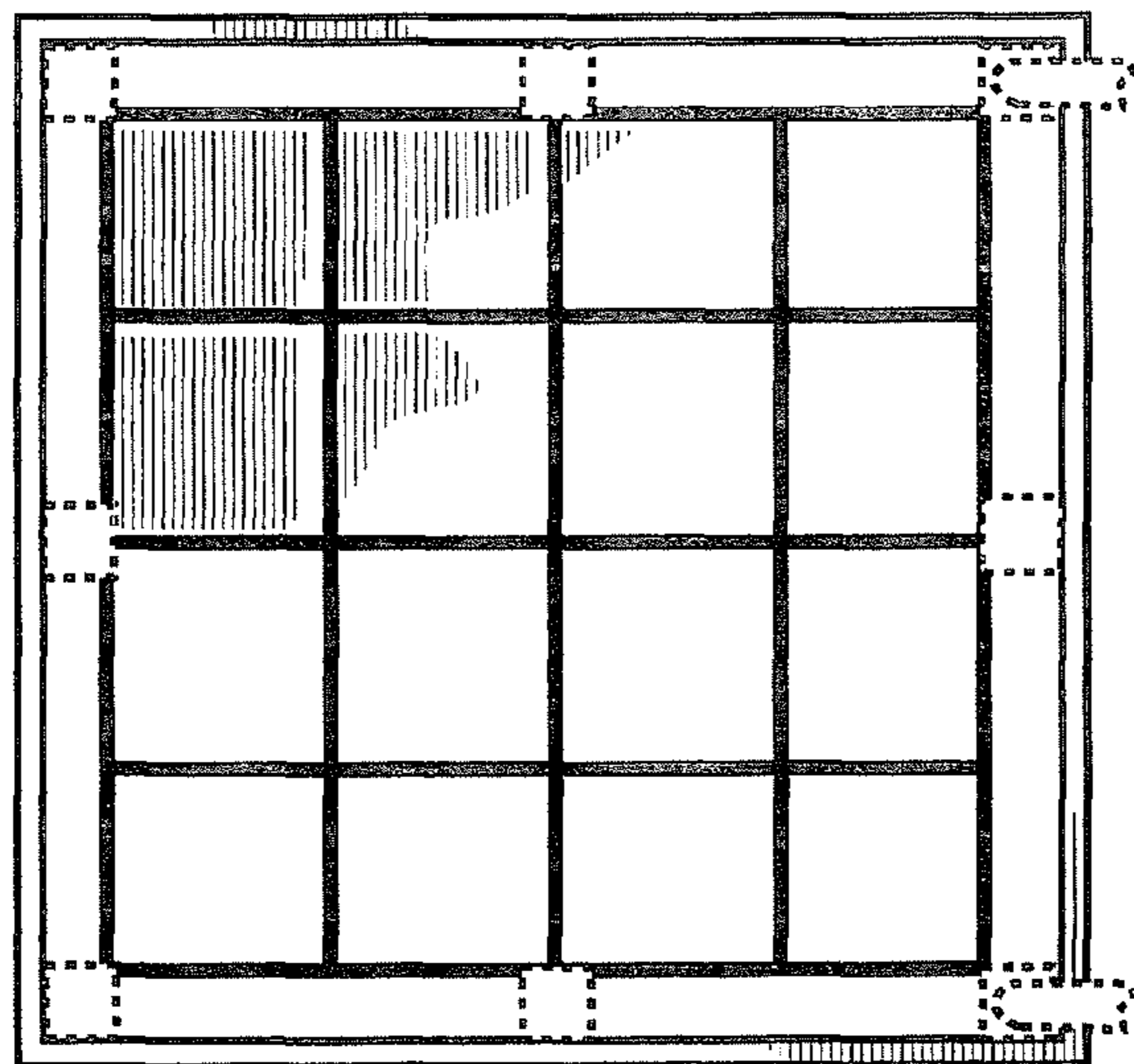

FIG. 2

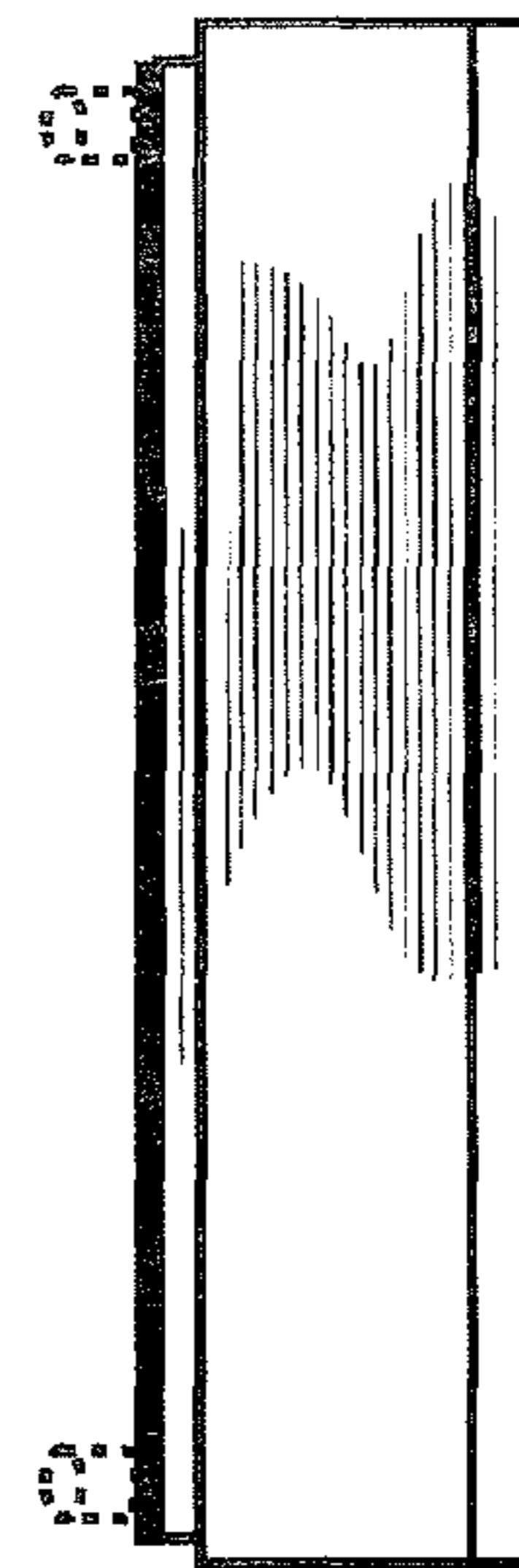

FIG. 3

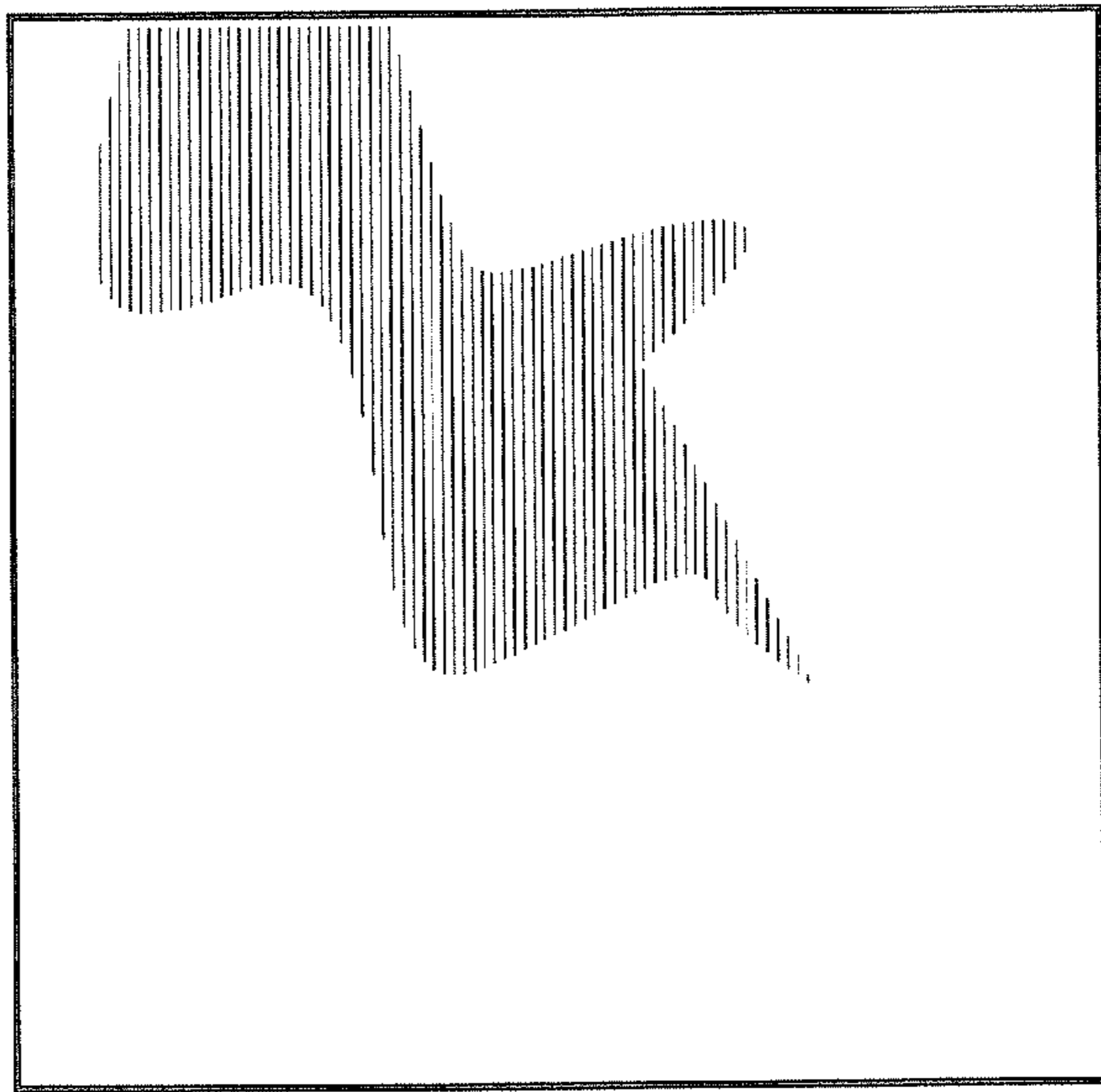

FIG. 4

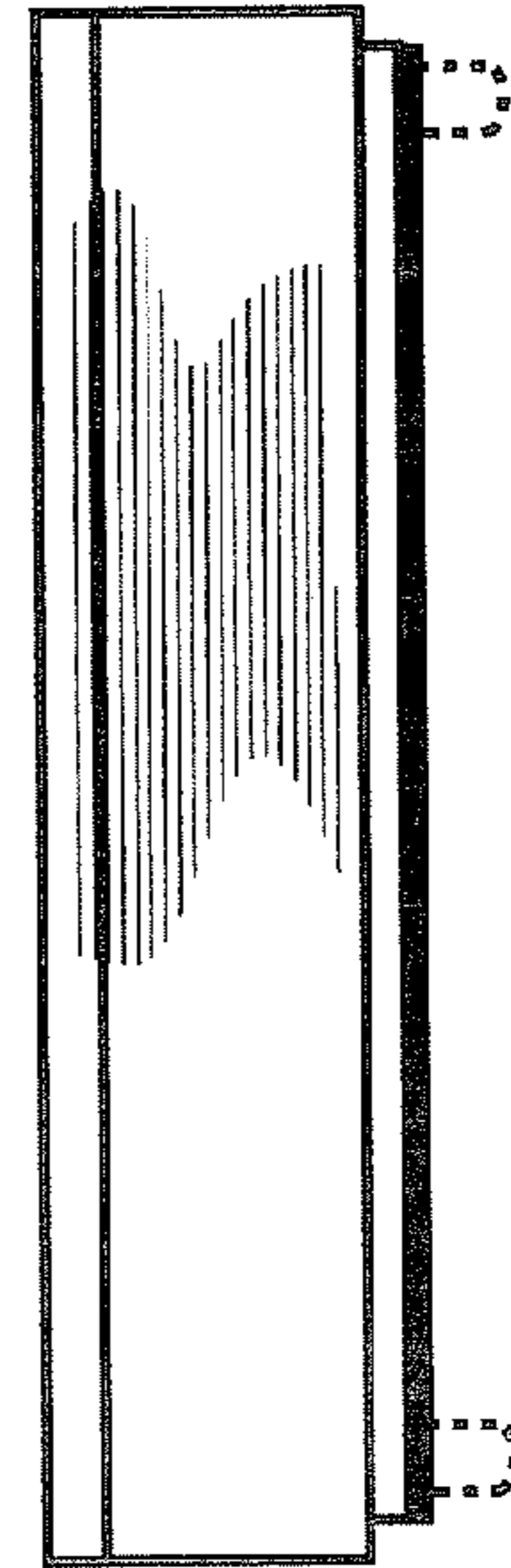

FIG. 5

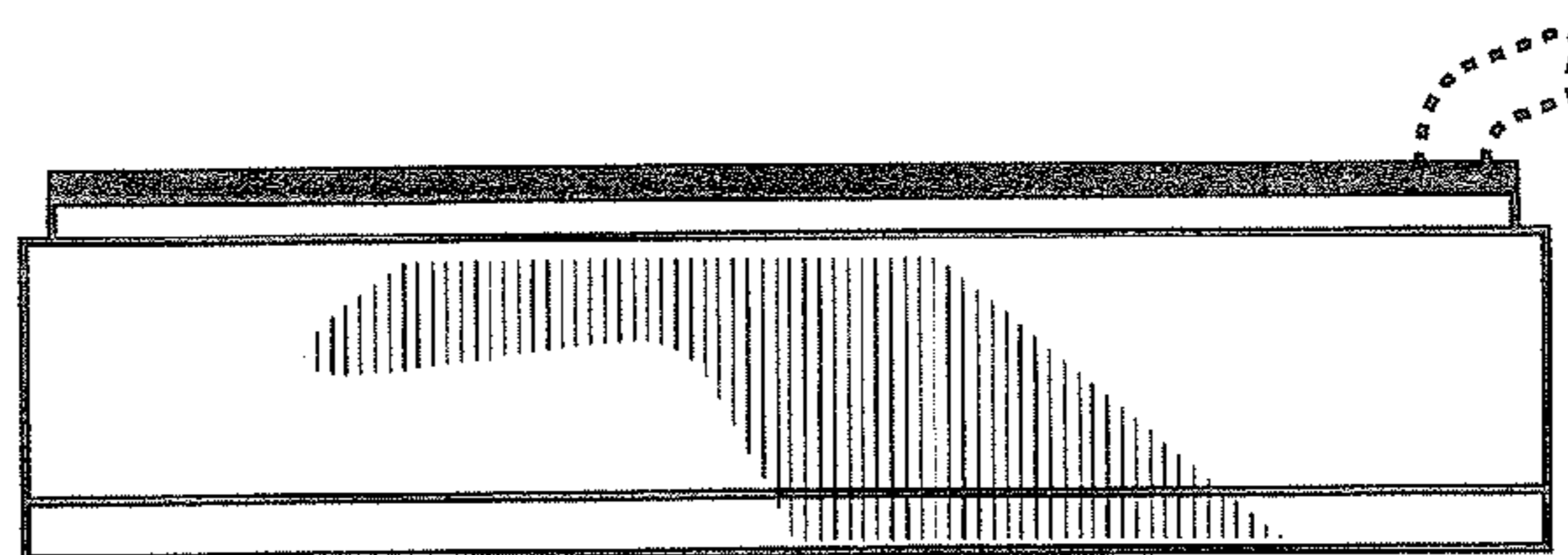

FIG. 6

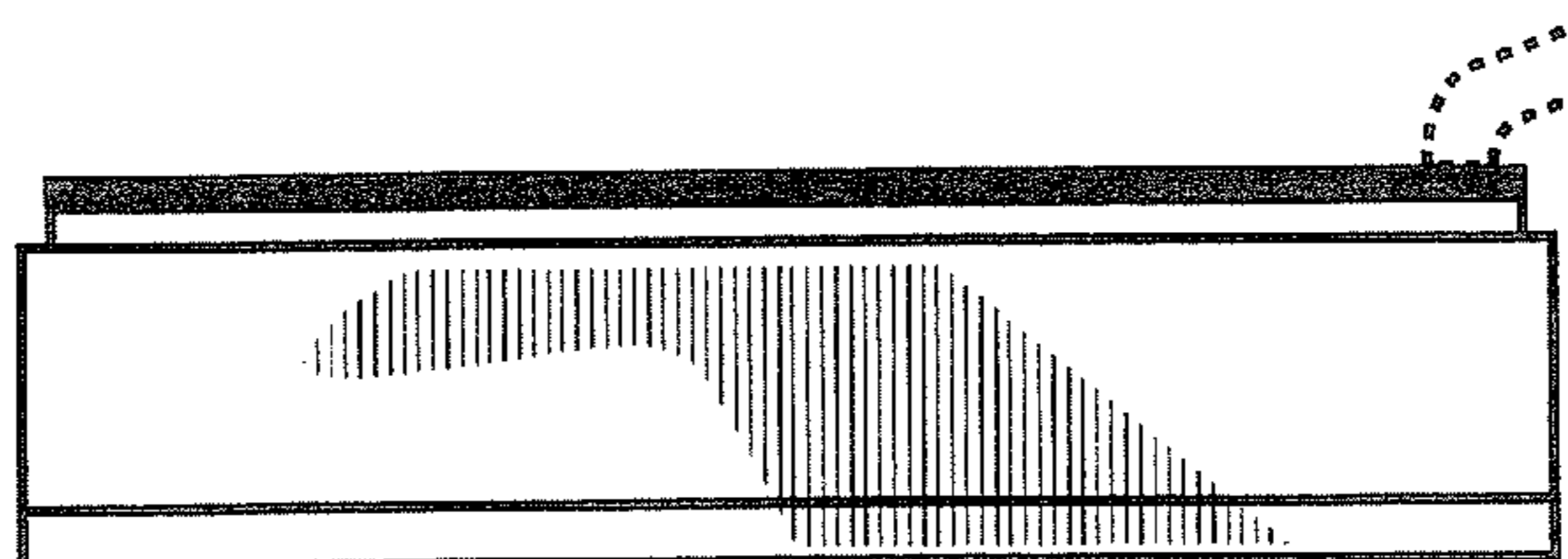

FIG. 7

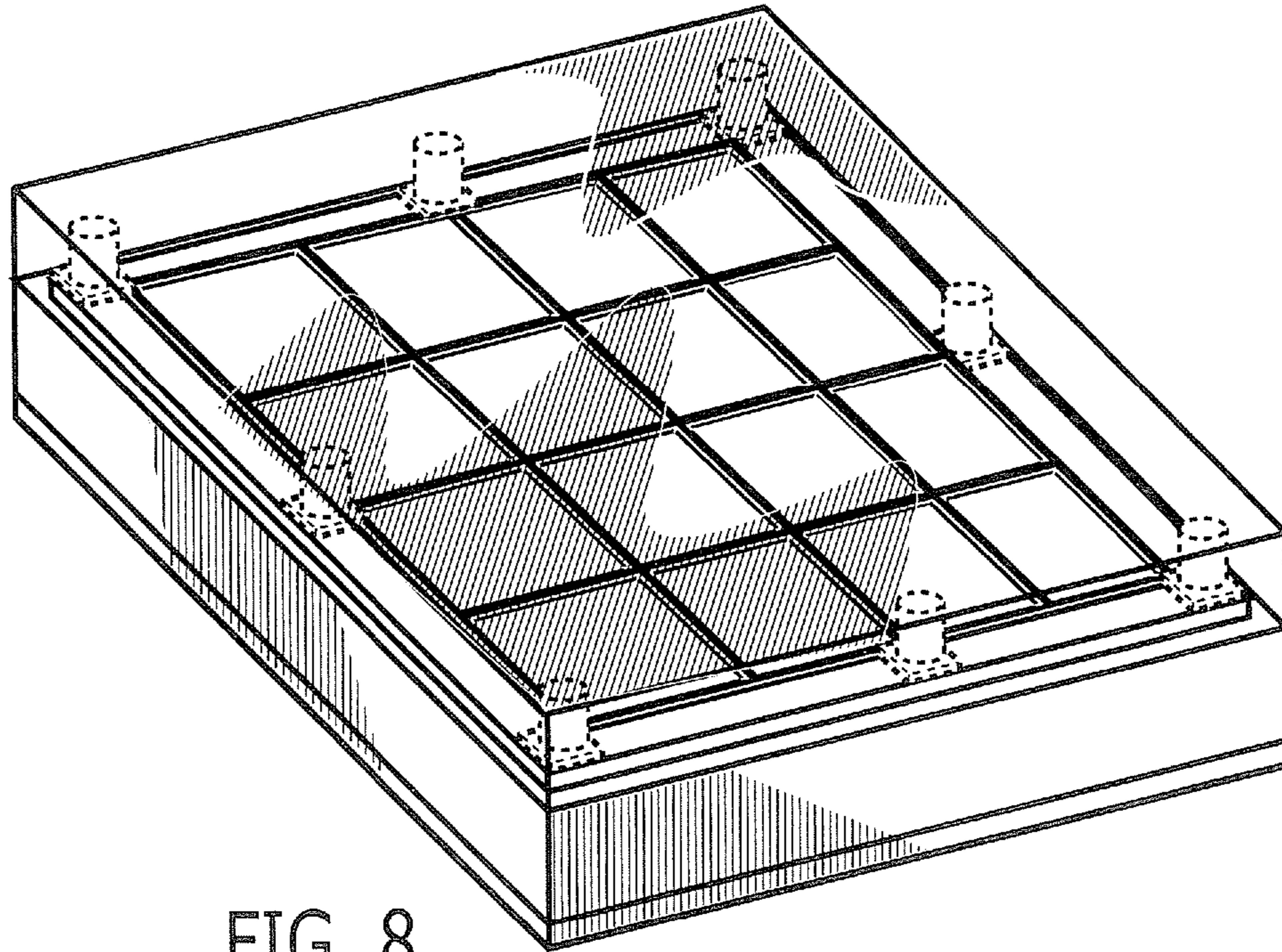

FIG. 8

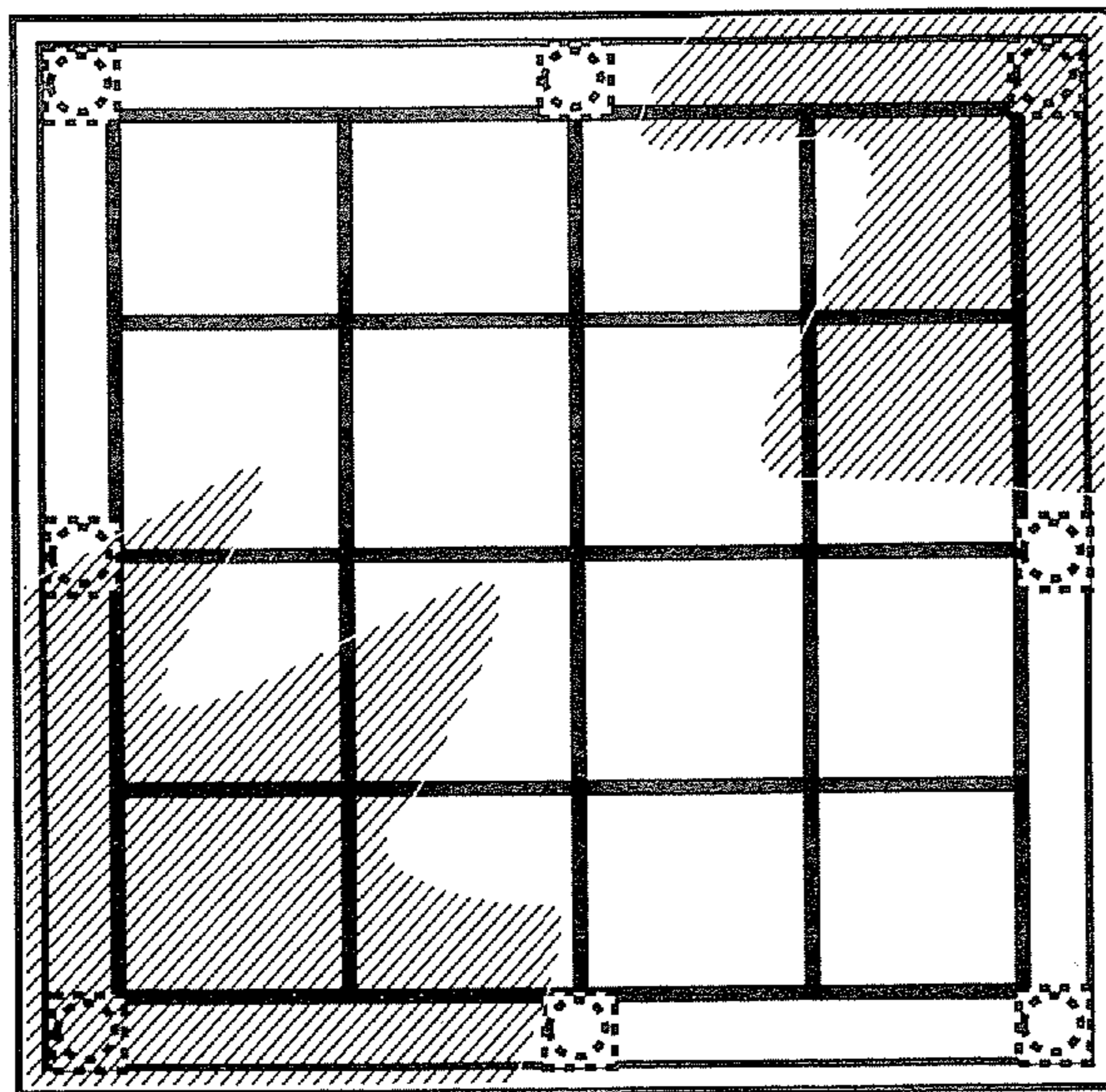

FIG. 9

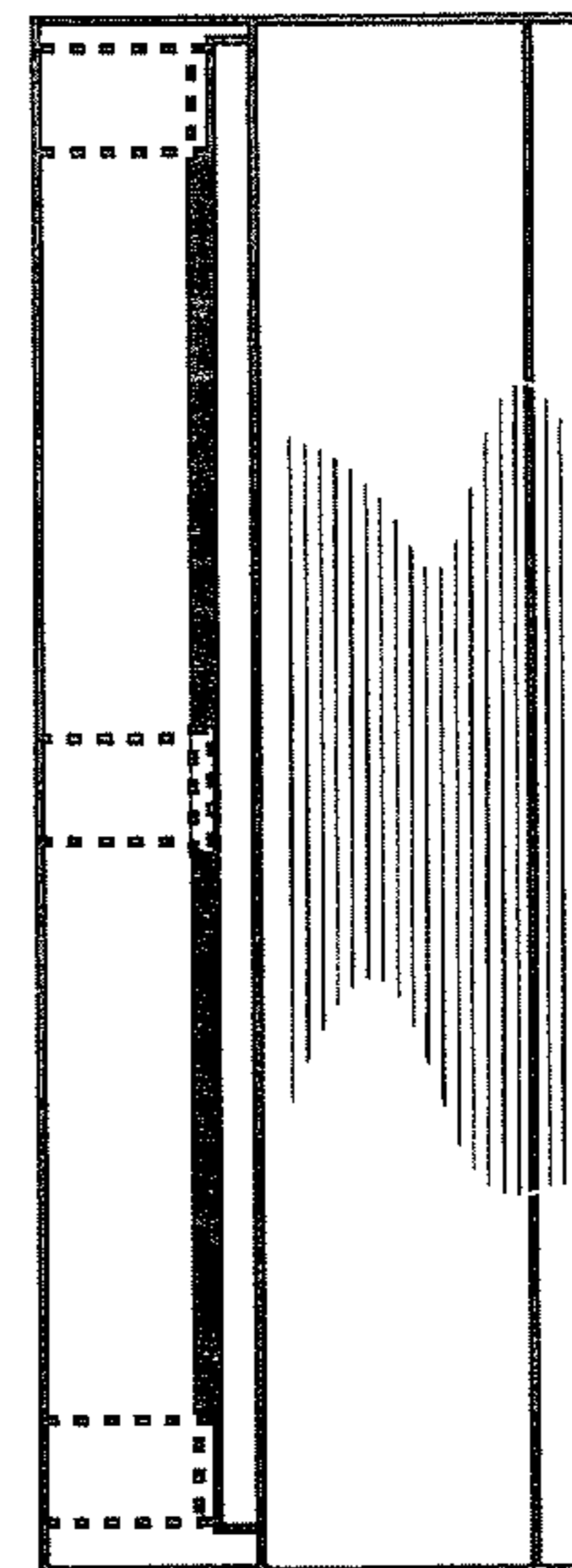

FIG. 10

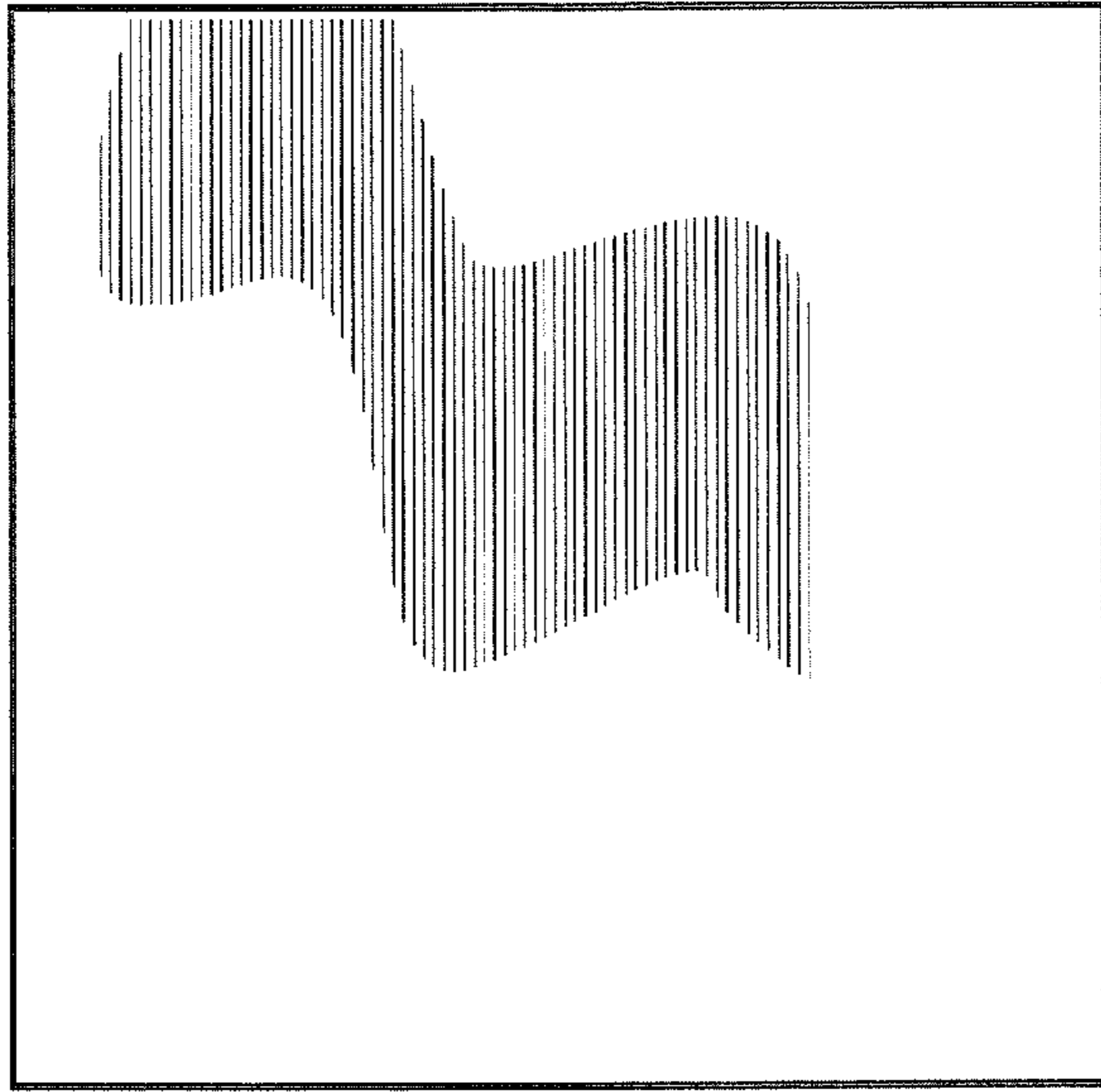

FIG. 11

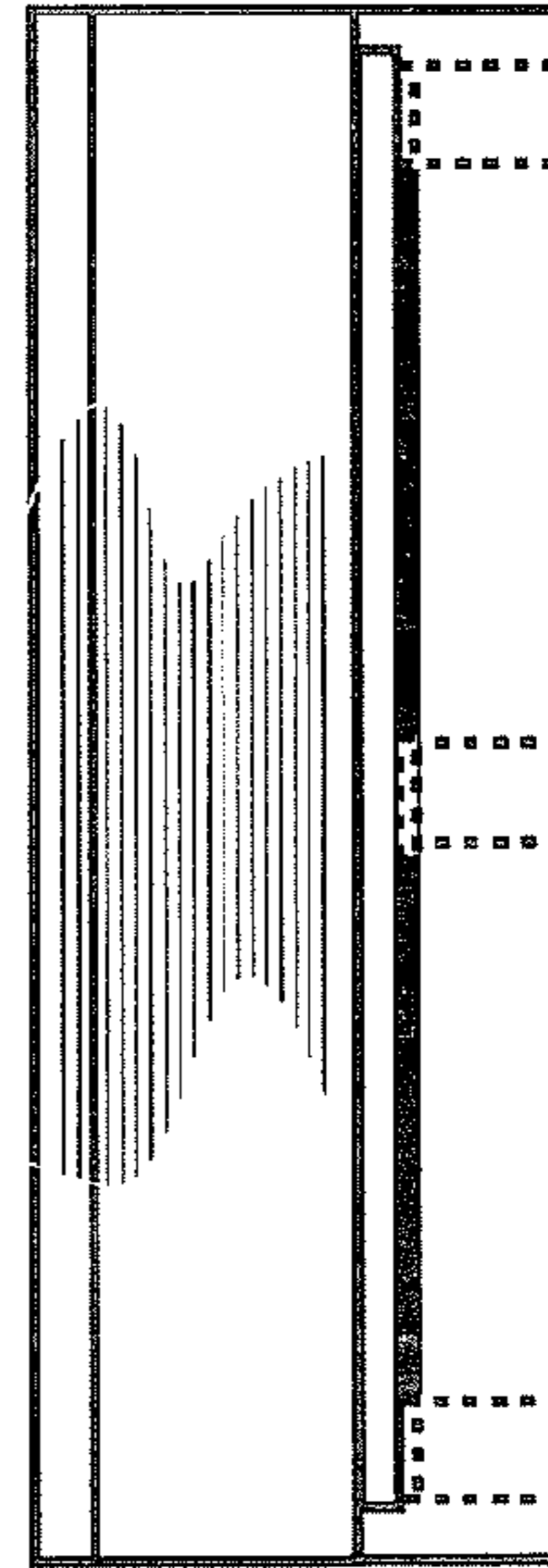

FIG. 12

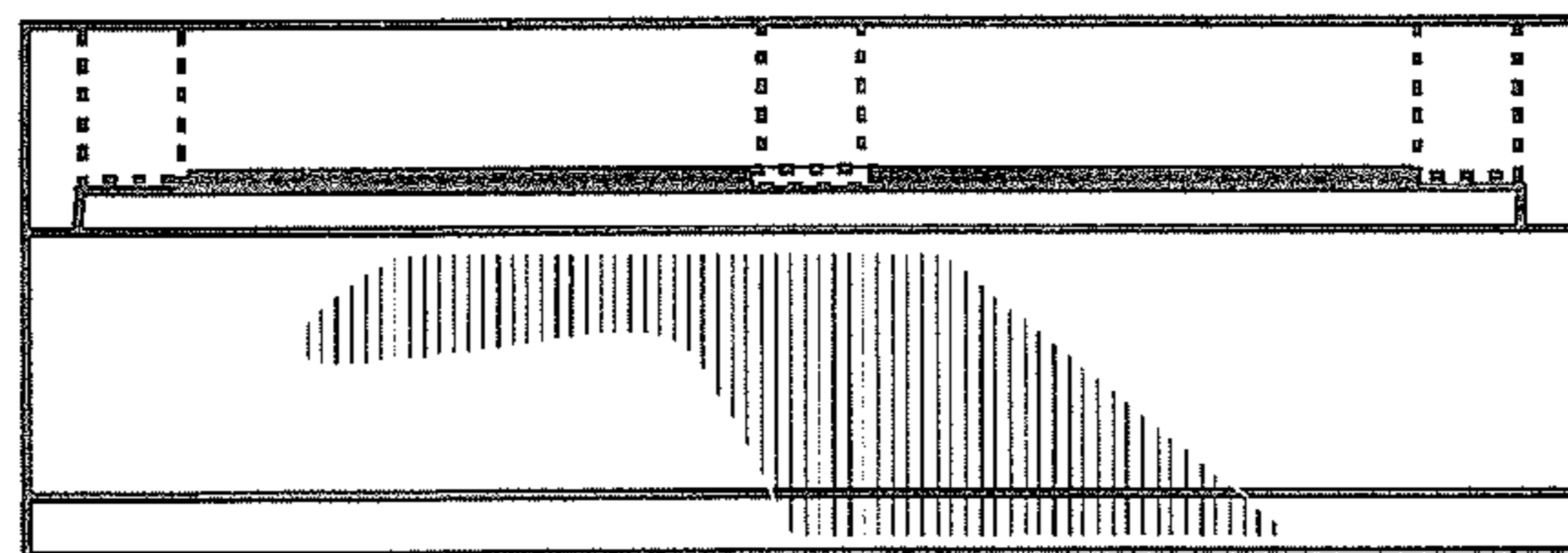

FIG. 13

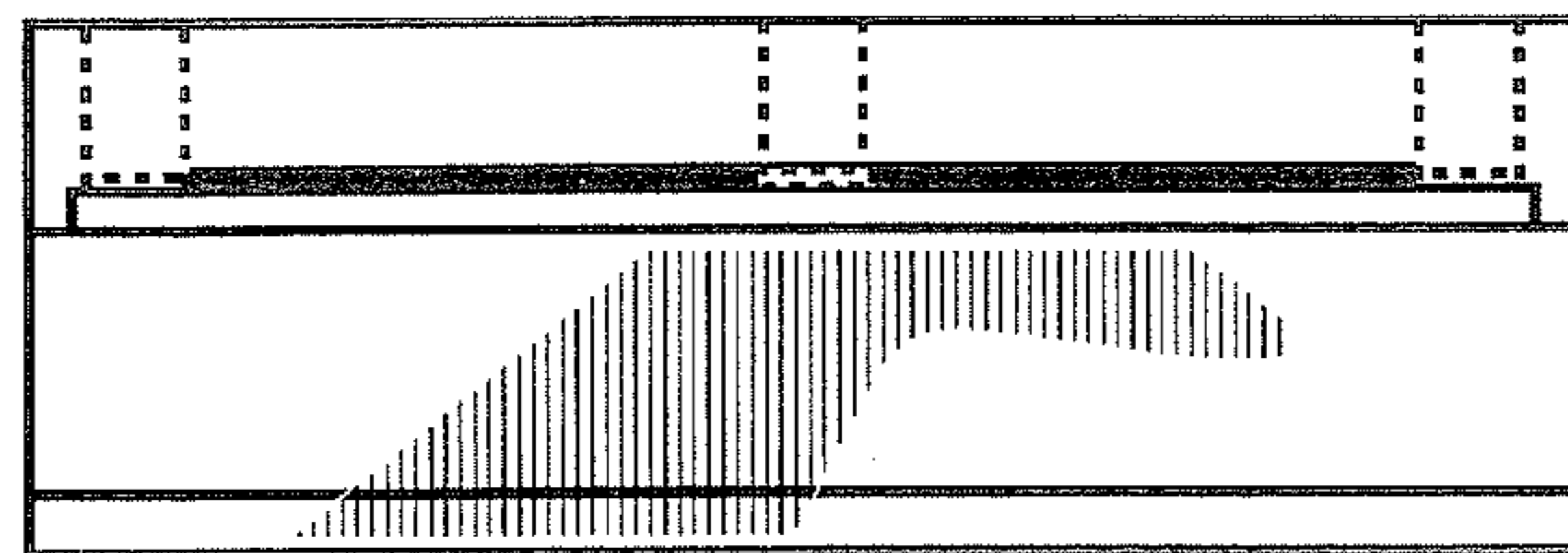

FIG. 14