



US00D616815S

(12) **United States Design Patent**  
**Jadraque Aznarez et al.**

(10) **Patent No.:** **US D616,815 S**  
(45) **Date of Patent:** **\*\* Jun. 1, 2010**

(54) **PHOTOVOLTAIC INVERTER**  
(75) Inventors: **Juan Carlos Jadraque Aznarez,**  
**Sarriguren (ES); Javier Aramendía**  
**Romero, Sarriguren (ES)**  
(73) Assignee: **Ingeteam Energy, S.A., Sarriguren**  
**(Navarra) (ES)**

D505,915 S \* 6/2005 Hussaini et al. .... D13/110  
D507,528 S \* 7/2005 Feldman et al. .... D13/110  
D558,141 S \* 12/2007 Kwon ..... D13/110  
7,304,852 B2 \* 12/2007 Hernandez et al. .... 361/714  
D560,607 S \* 1/2008 Suematsu et al. .... D13/110  
D561,688 S \* 2/2008 Hussaini et al. .... D13/110  
D562,235 S \* 2/2008 Hussaini et al. .... D13/110

(\*\*) Term: **14 Years**  
(21) Appl. No.: **29/335,671**  
(22) Filed: **Apr. 20, 2009**

\* cited by examiner

*Primary Examiner*—Prabhakar Deshmukh  
*Assistant Examiner*—Derrick Holland  
(74) *Attorney, Agent, or Firm*—Wenderoth, Lind & Ponack,  
L.L.P.

(30) **Foreign Application Priority Data**  
Jan. 26, 2009 (EM) ..... 001075733-0001

(57) **CLAIM**

The ornamental design for a photovoltaic inverter, as shown and described.

(51) **LOC (9) Cl.** ..... **13-02**  
(52) **U.S. Cl.** ..... **D13/110**  
(58) **Field of Classification Search** ..... D13/110,  
D13/101, 123, 124, 164, 184, 199; D14/240,  
D14/242, 356–358, 432, 433, 496; 136/243,  
136/248; 361/600, 601, 622, 703, 730, 733;  
363/15, 16, 34, 39, 40, 95, 109  
See application file for complete search history.

**DESCRIPTION**

FIG. 1 is a front perspective view of a photovoltaic inverter showing our new design;  
FIG. 2 is a bottom perspective view thereof;  
FIG. 3 is a front view thereof;  
FIG. 4 is a right side view thereof;  
FIG. 5 is a top view thereof;  
FIG. 6 is a rear view thereof;  
FIG. 7 is a left side thereof; and,  
FIG. 8 is a bottom view thereof.

The broken lines shown represent unclaimed subject matter and form no part of the claimed design.

(56) **References Cited**  
U.S. PATENT DOCUMENTS  
5,949,640 A \* 9/1999 Cameron et al. .... 361/600  
6,111,767 A \* 8/2000 Handleman ..... 363/95  
D437,314 S \* 2/2001 DeLeon ..... D14/242  
D450,295 S \* 11/2001 Okayama et al. .... D13/110  
D455,399 S \* 4/2002 Imamura et al. .... D13/110  
D459,313 S \* 6/2002 Kim ..... D13/164  
D502,916 S \* 3/2005 Higuchi et al. .... D13/110

**1 Claim, 8 Drawing Sheets**

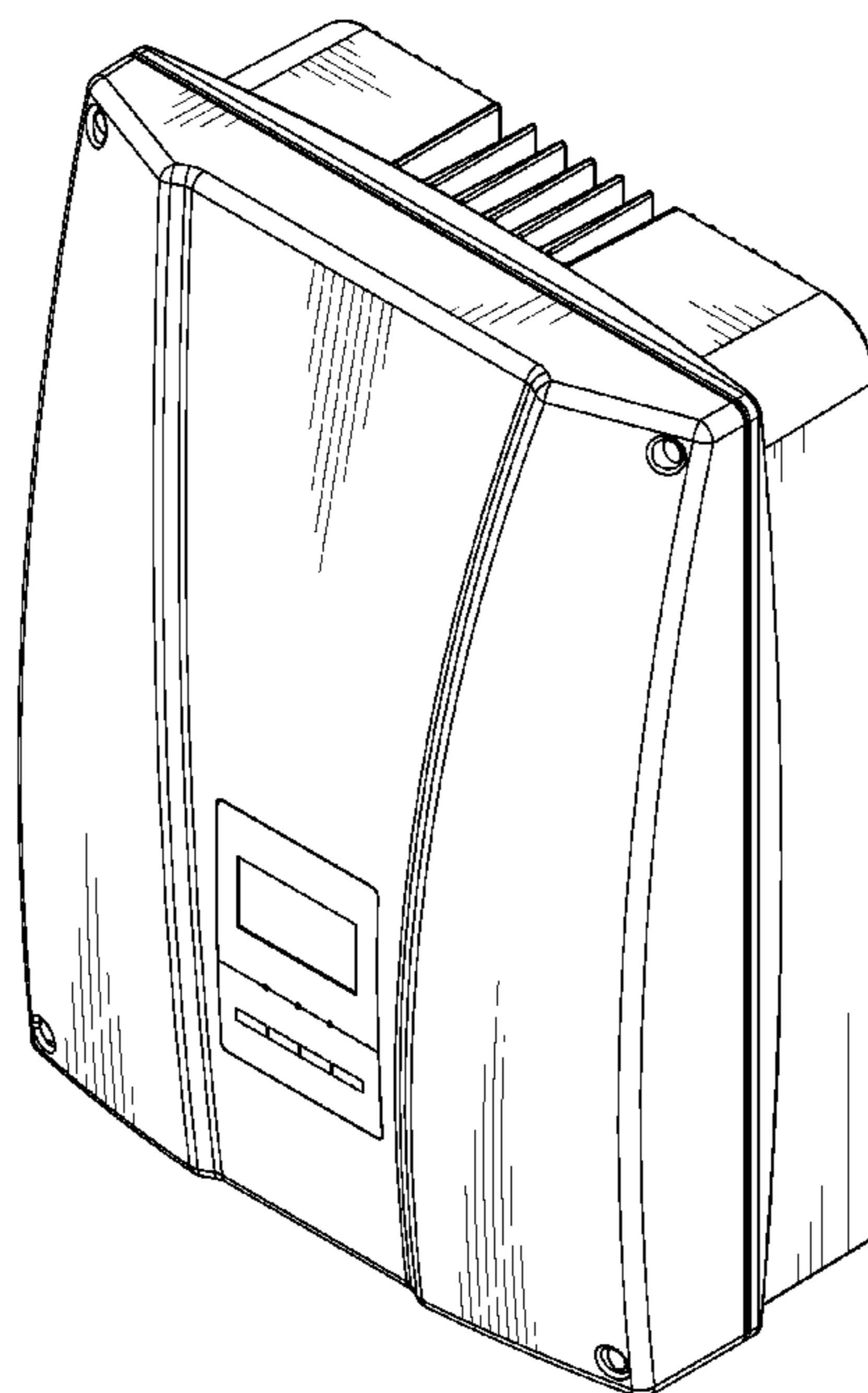

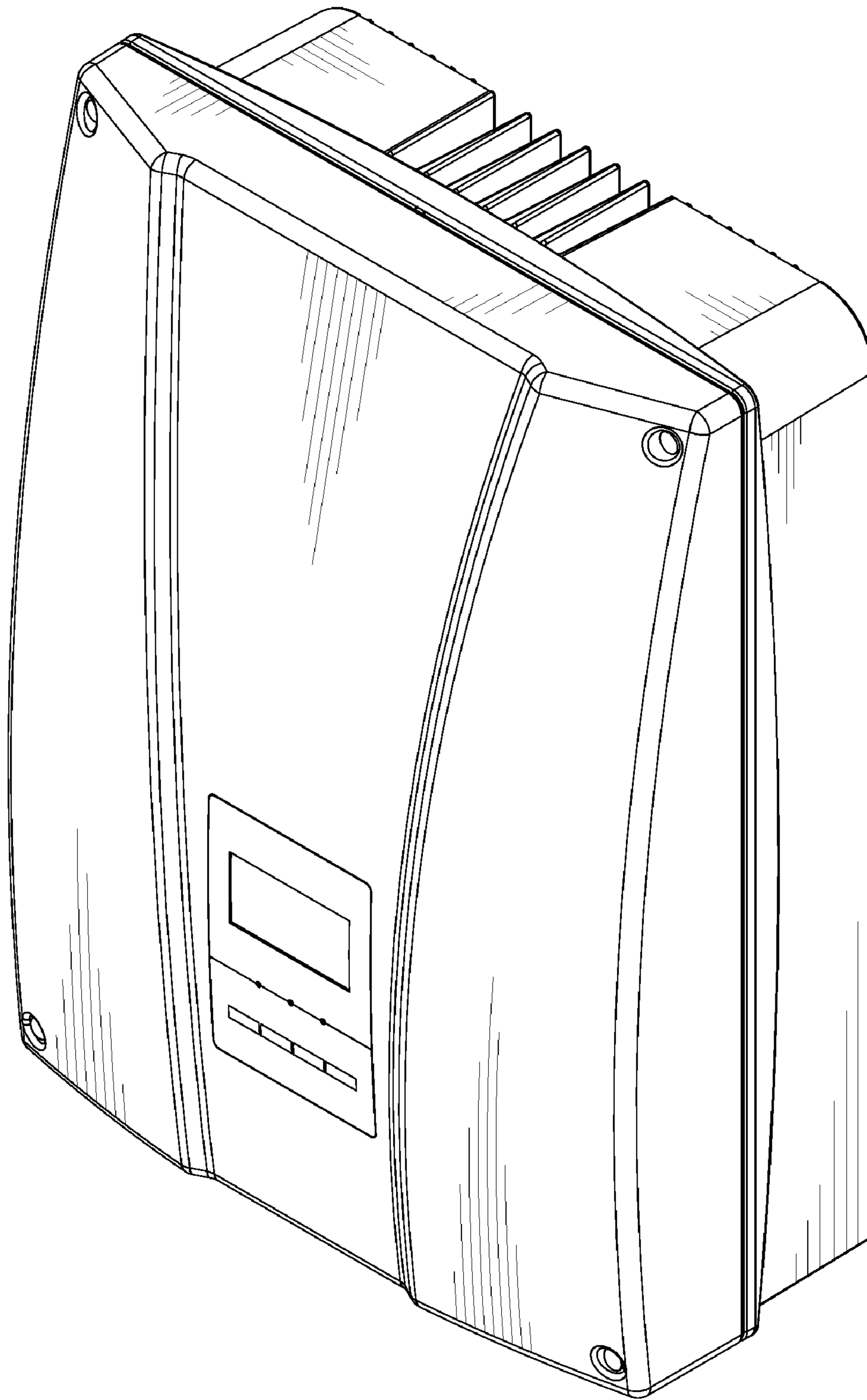

FIG. 1

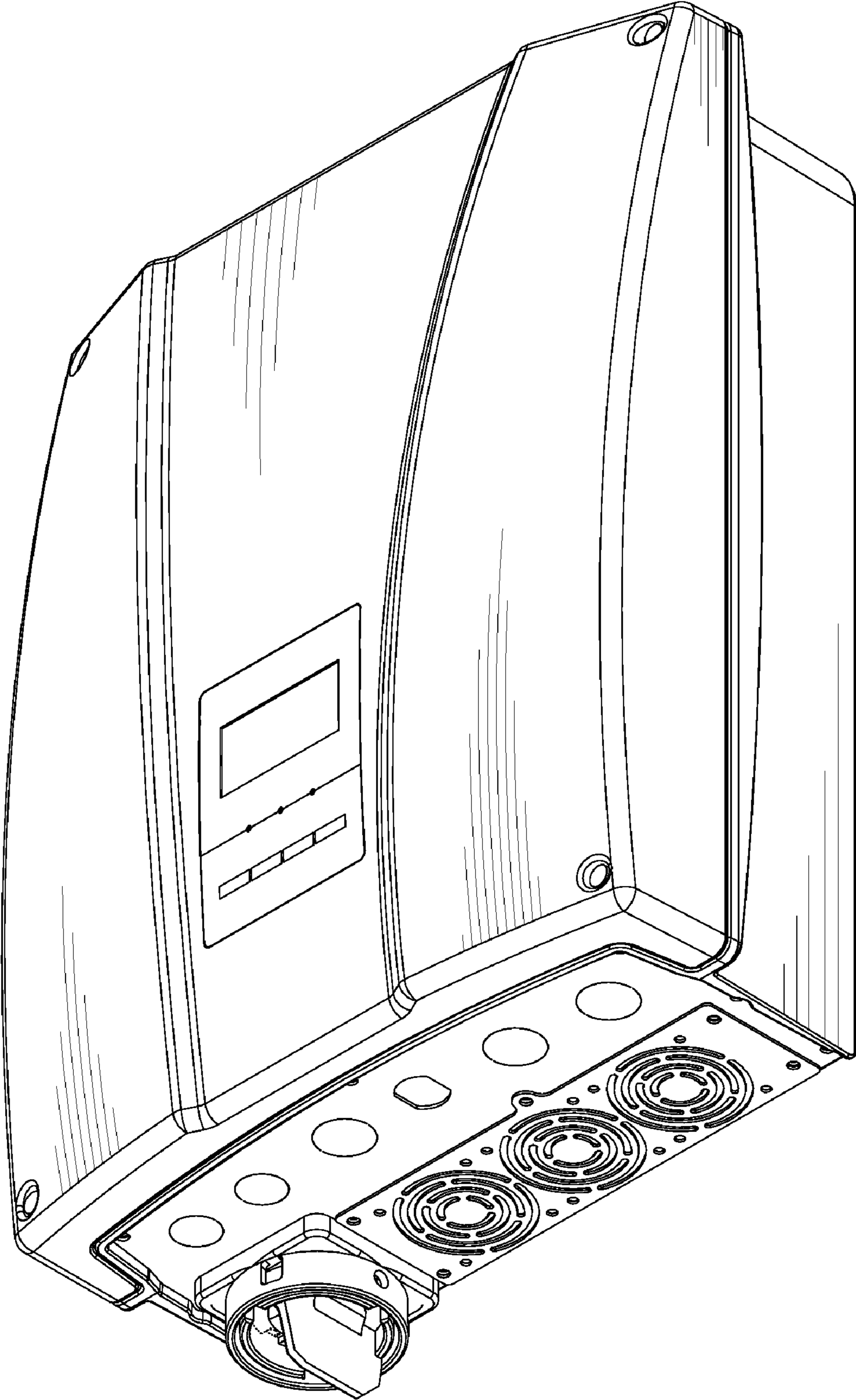

FIG. 2

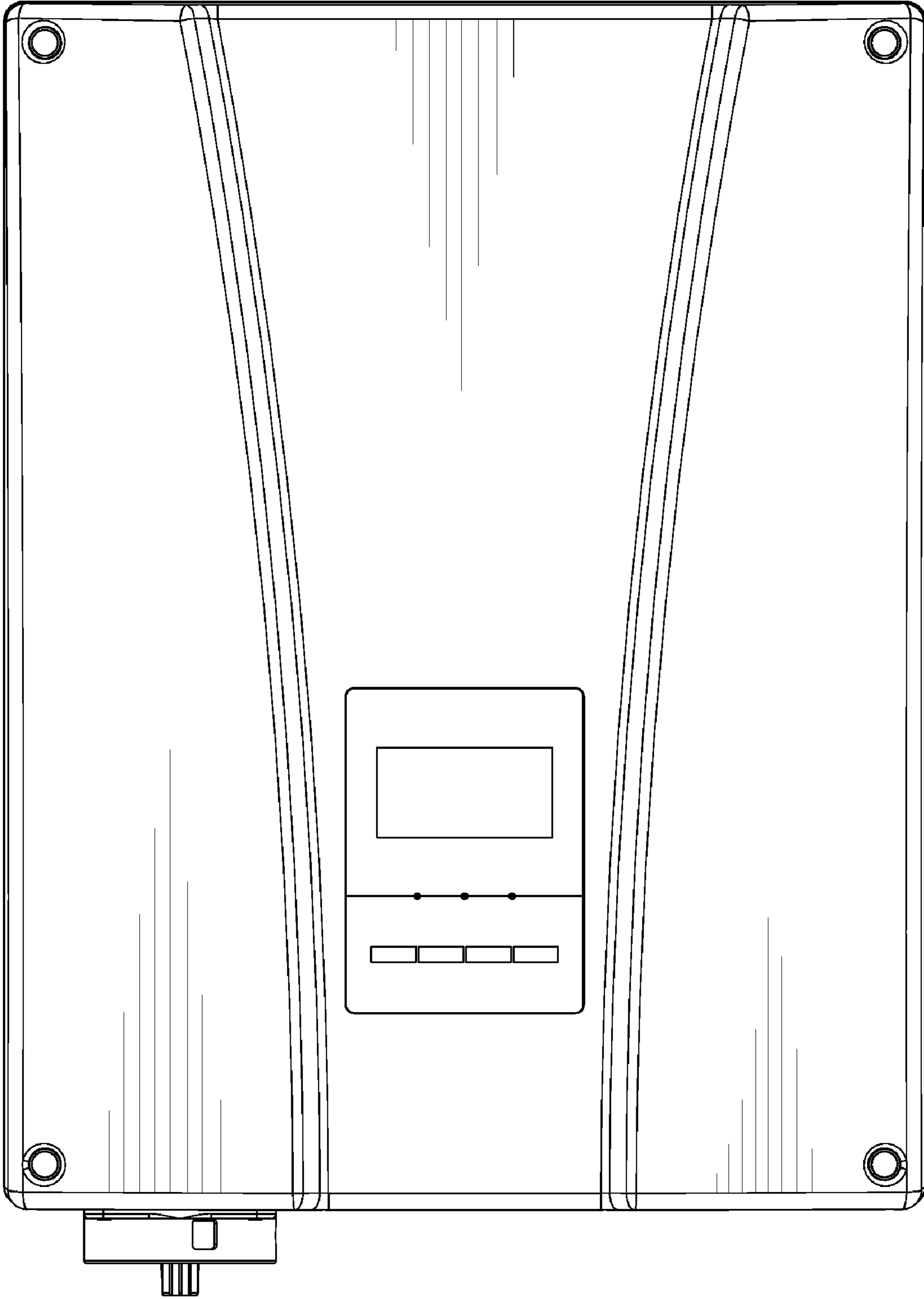

FIG. 3

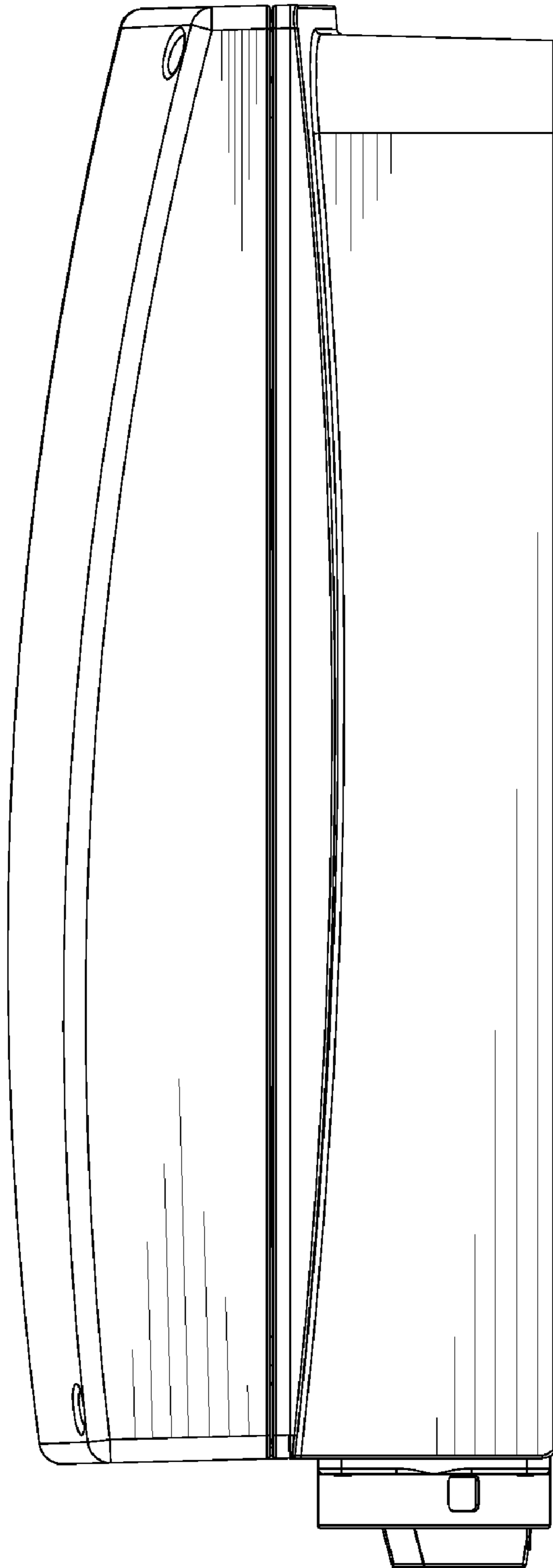

FIG. 4

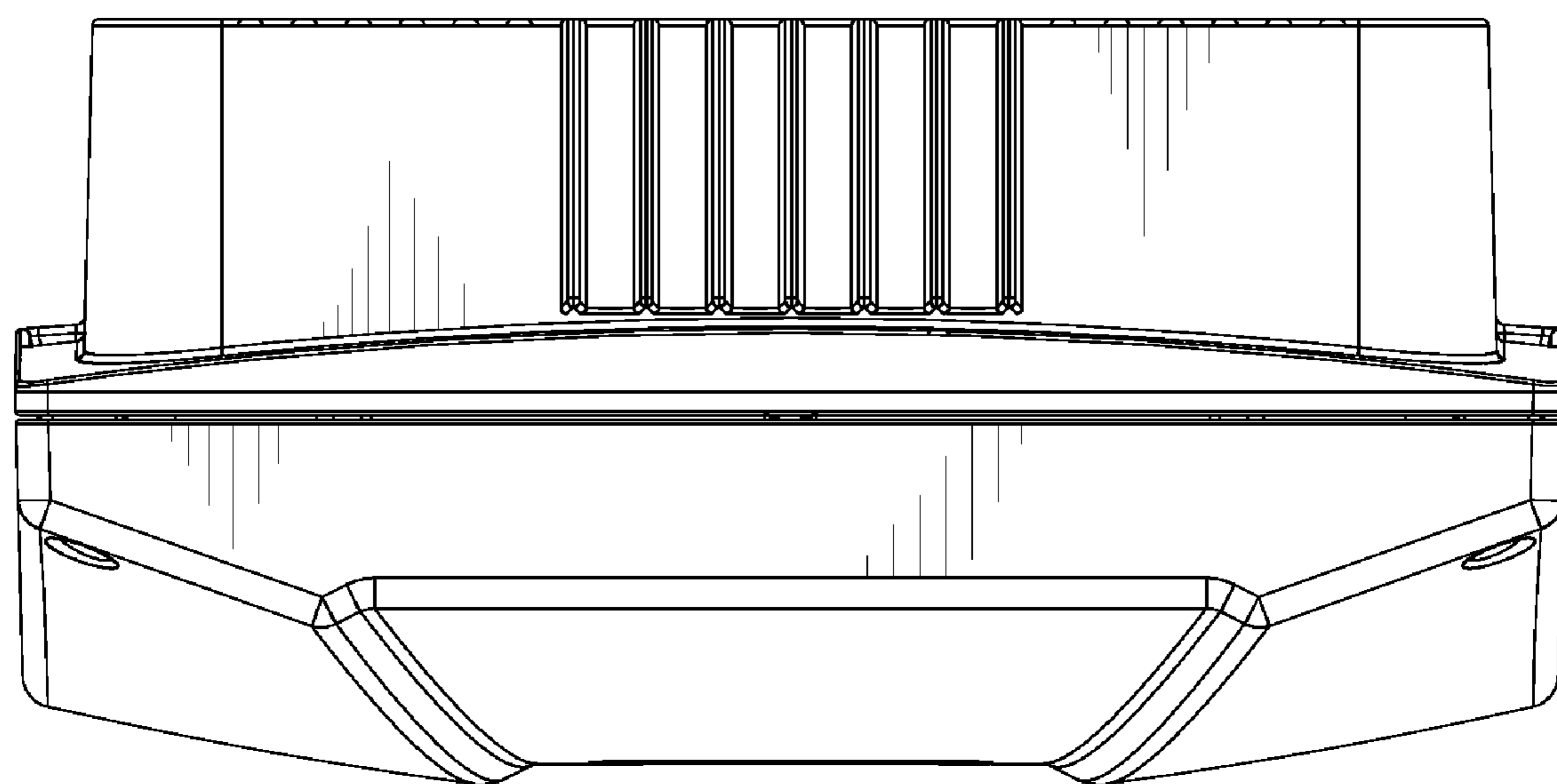

FIG. 5

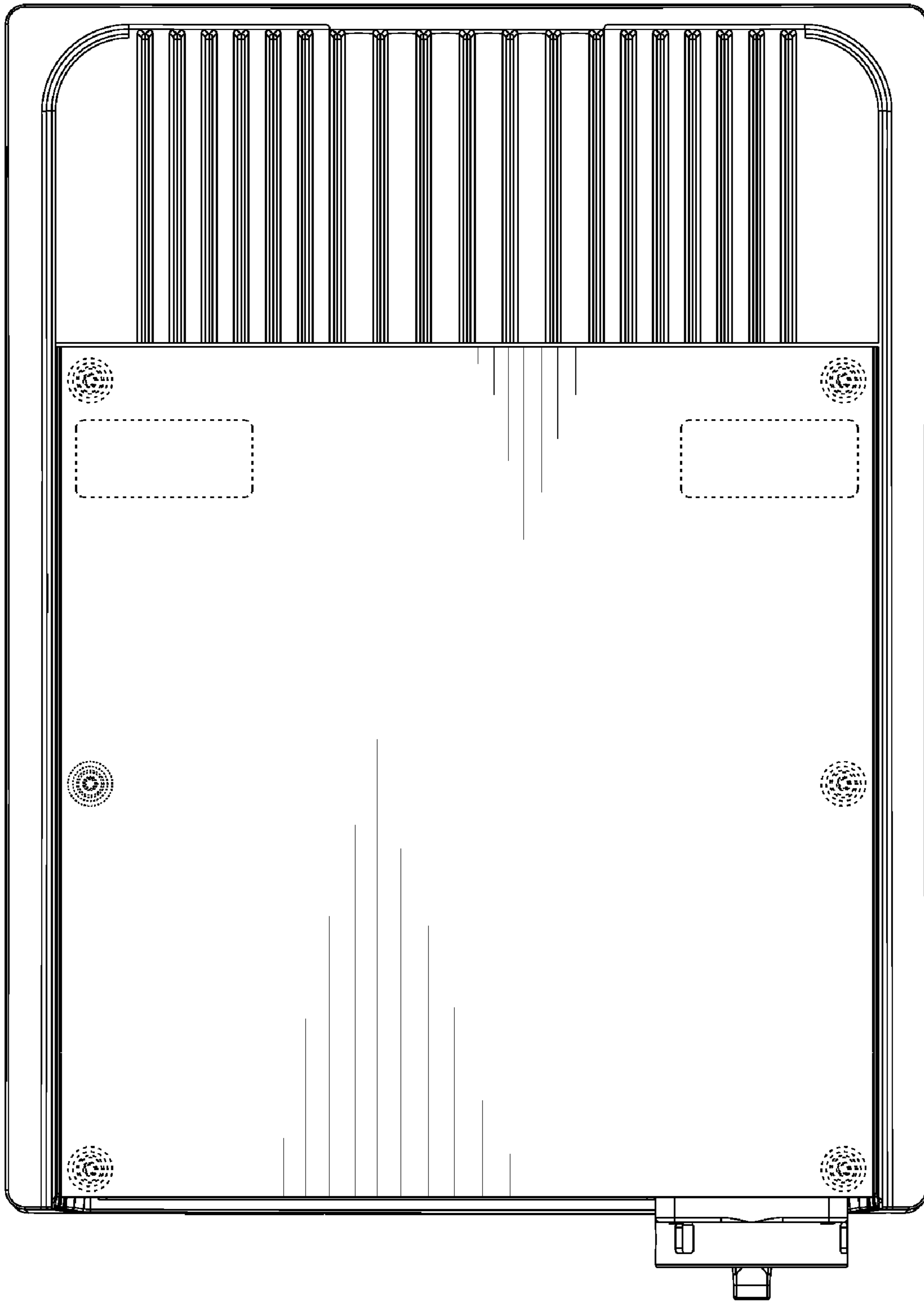

FIG. 6

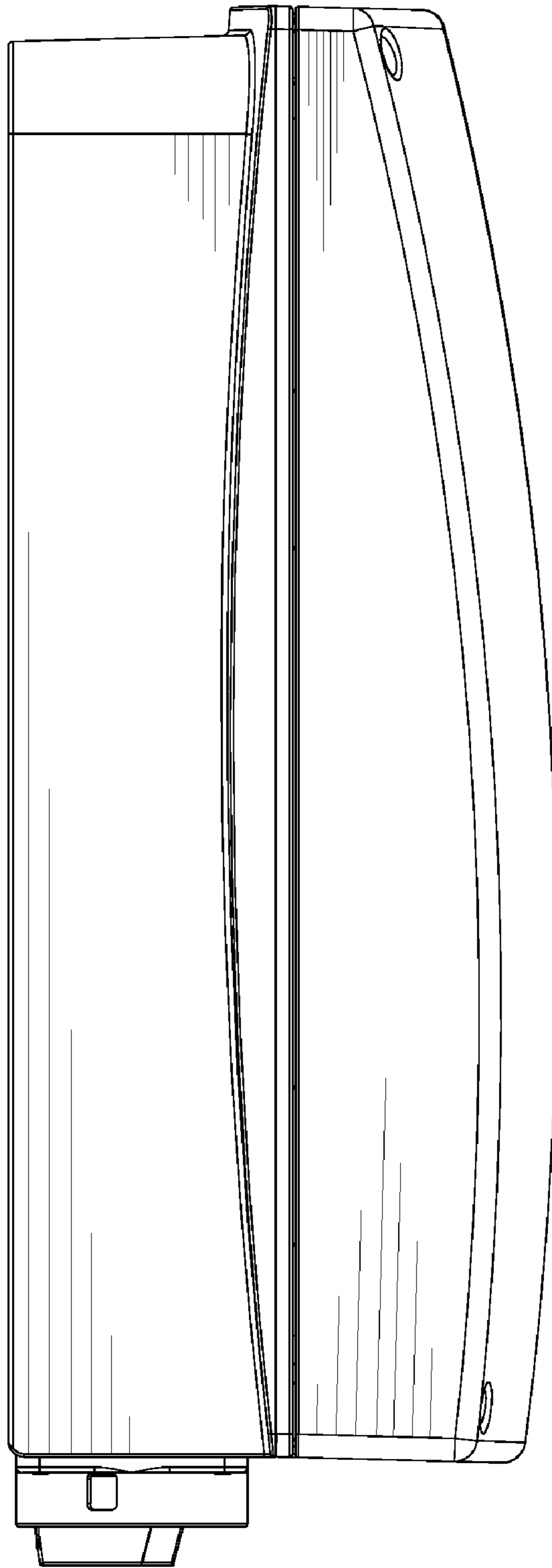

FIG. 7



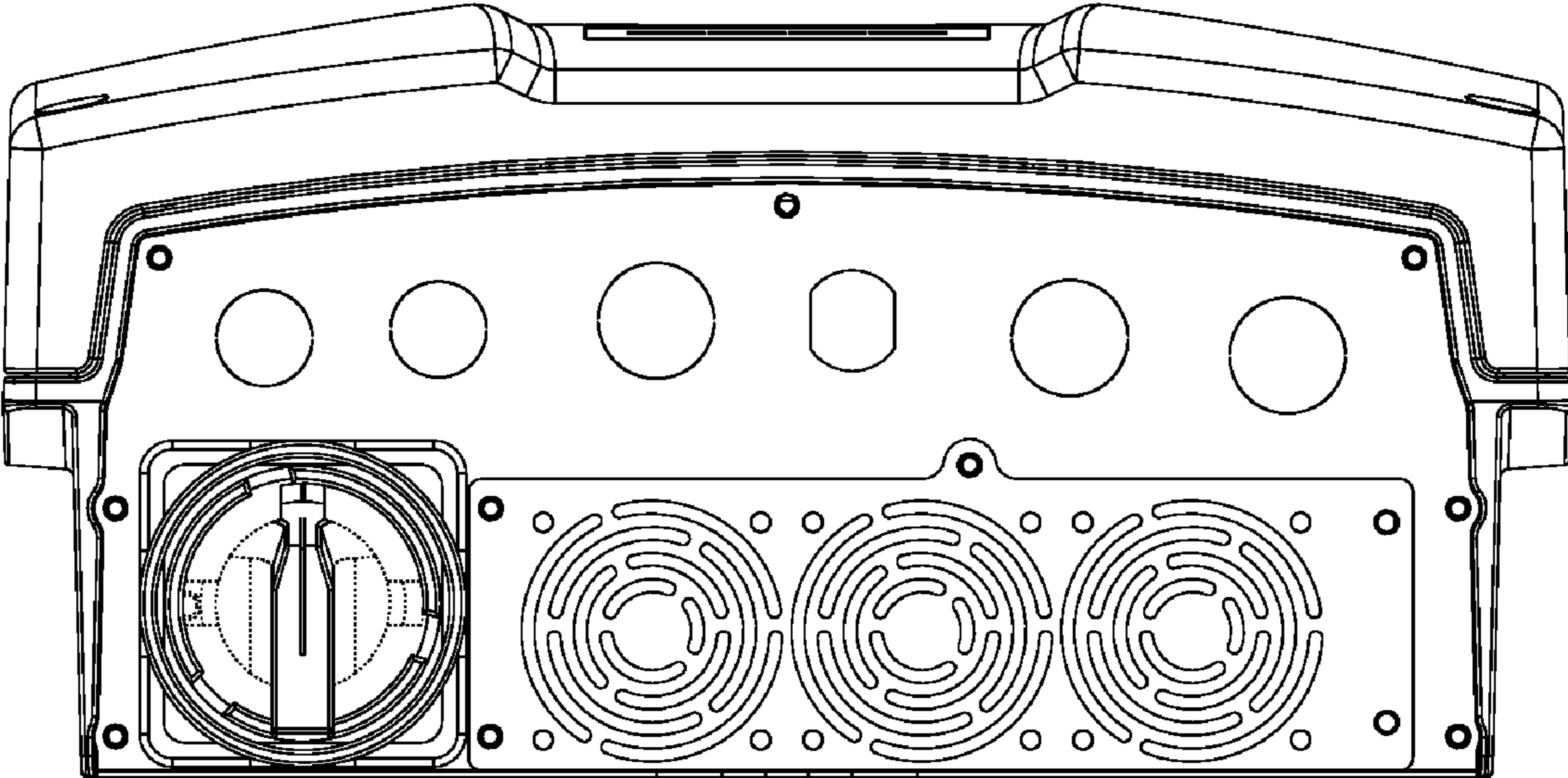

FIG. 8