



US00D616653S

(12) **United States Design Patent**
Mann

(10) **Patent No.:** **US D616,653 S**
(45) **Date of Patent:** **** Jun. 1, 2010**

(54) **SWING CHAIR**

(75) Inventor: **Miles Mann**, Ludlow (GB)

(73) Assignee: **TP Activity Toys Limited**,
Stourport-on-Severn, Worcestershire
(GB)

(**) Term: **14 Years**

(21) Appl. No.: **29/322,474**

(22) Filed: **Aug. 5, 2008**

(51) **LOC (9) Cl.** **06-01**

(52) **U.S. Cl.** **D6/344**

(58) **Field of Classification Search** D6/333-336,
D6/339-341, 344, 500-502, 347, 375; 297/250.1,
297/256.14, 256.15, 256.16, 183.2, 182.3,
297/182.4, 468, 259.3; 472/118; 446/482;
D21/419, 412; 5/94, 103-104

See application file for complete search history.

(56) **References Cited**

U.S. PATENT DOCUMENTS

D366,965 S * 2/1996 Meeker et al. D6/333

D427,785 S * 7/2000 Kassai D6/333
D487,640 S * 3/2004 Chen D6/333
D557,512 S * 12/2007 Wu et al. D6/344
D601,358 S * 10/2009 Yu D6/344

* cited by examiner

Primary Examiner—Caron Veynar

Assistant Examiner—Abraham Bahta

(74) *Attorney, Agent, or Firm*—Bryan Cave LLP

(57) **CLAIM**

The ornamental design for a swing chair, as shown and described.

DESCRIPTION

FIG. 1 is a top view of the swing chair showing my new design;

FIG. 2 is a front view thereof;

FIG. 3 is a rear view thereof;

FIG. 4 is a left side view thereof;

FIG. 5 is a front, right, top isometric view thereof; and,

FIG. 6 is a rear, right isometric view thereof.

1 Claim, 6 Drawing Sheets

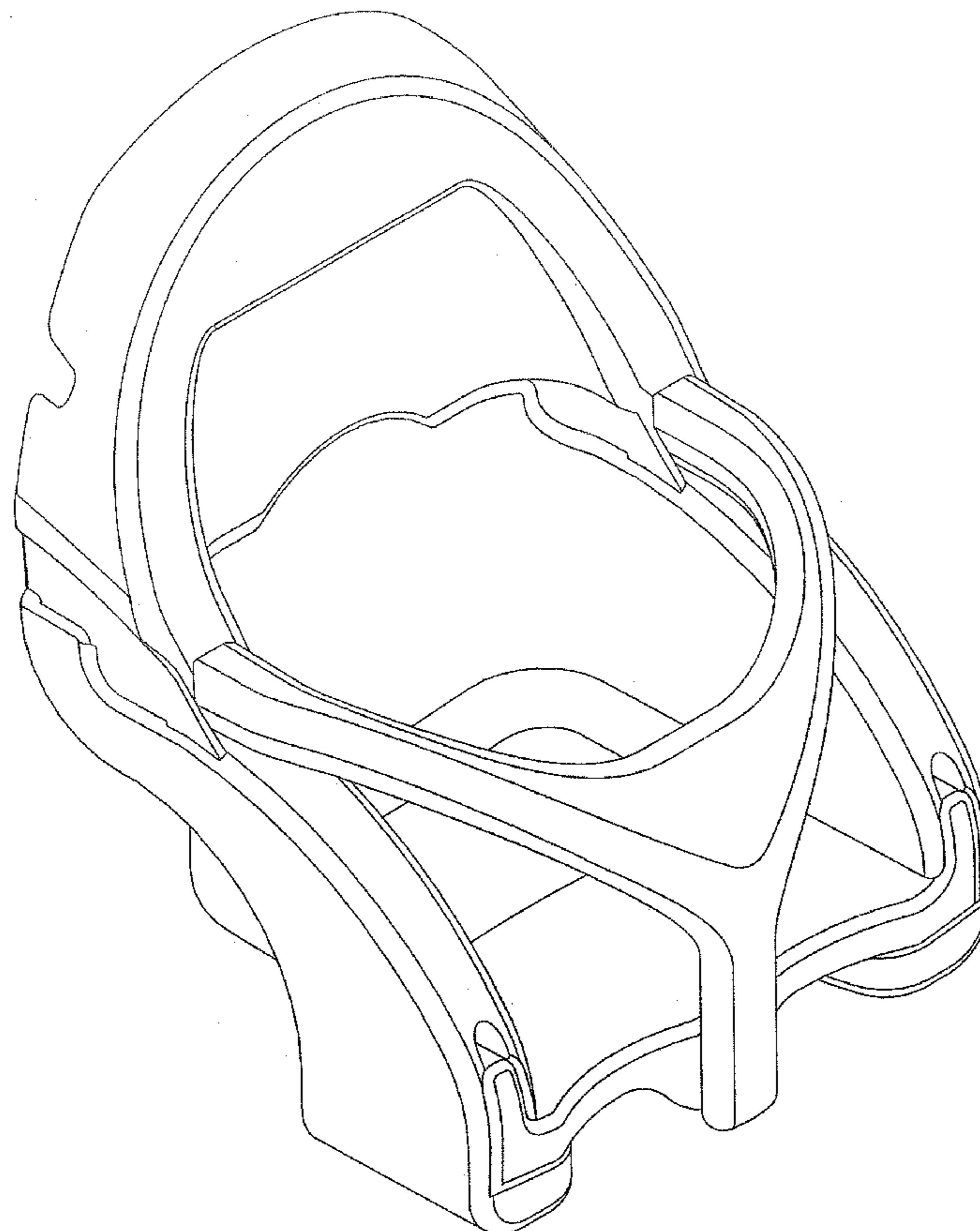

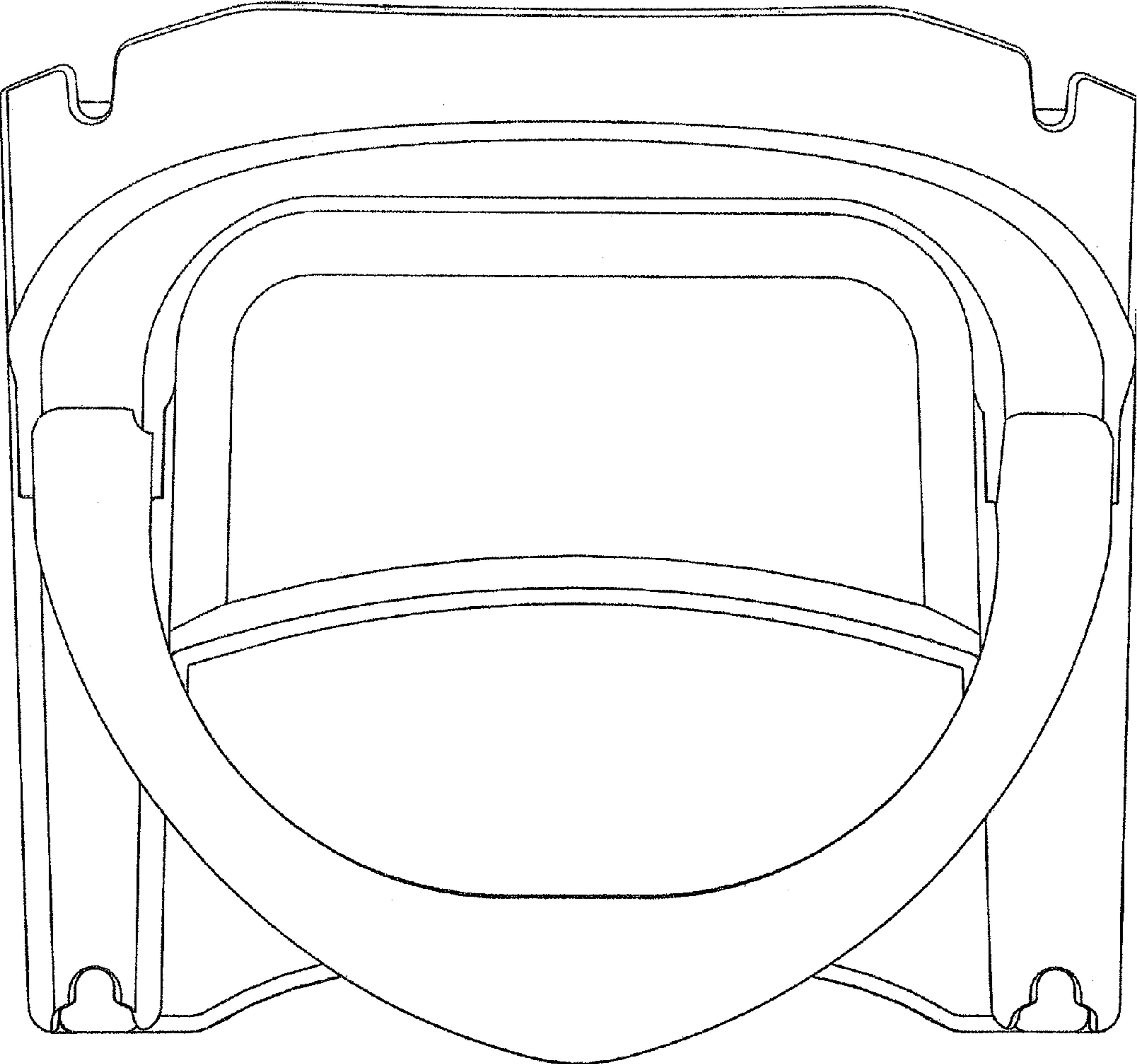

FIG. 1

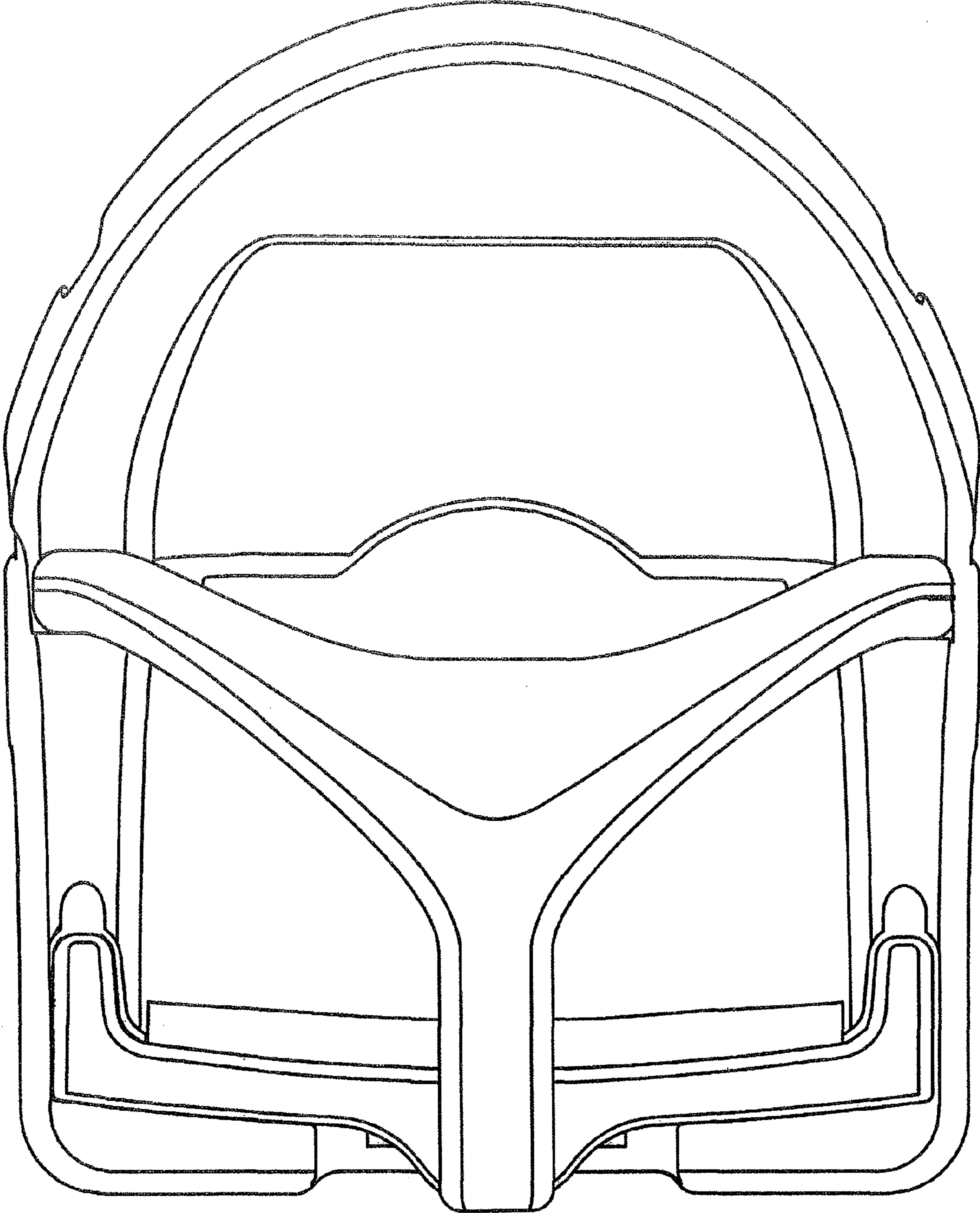

FIG. 2

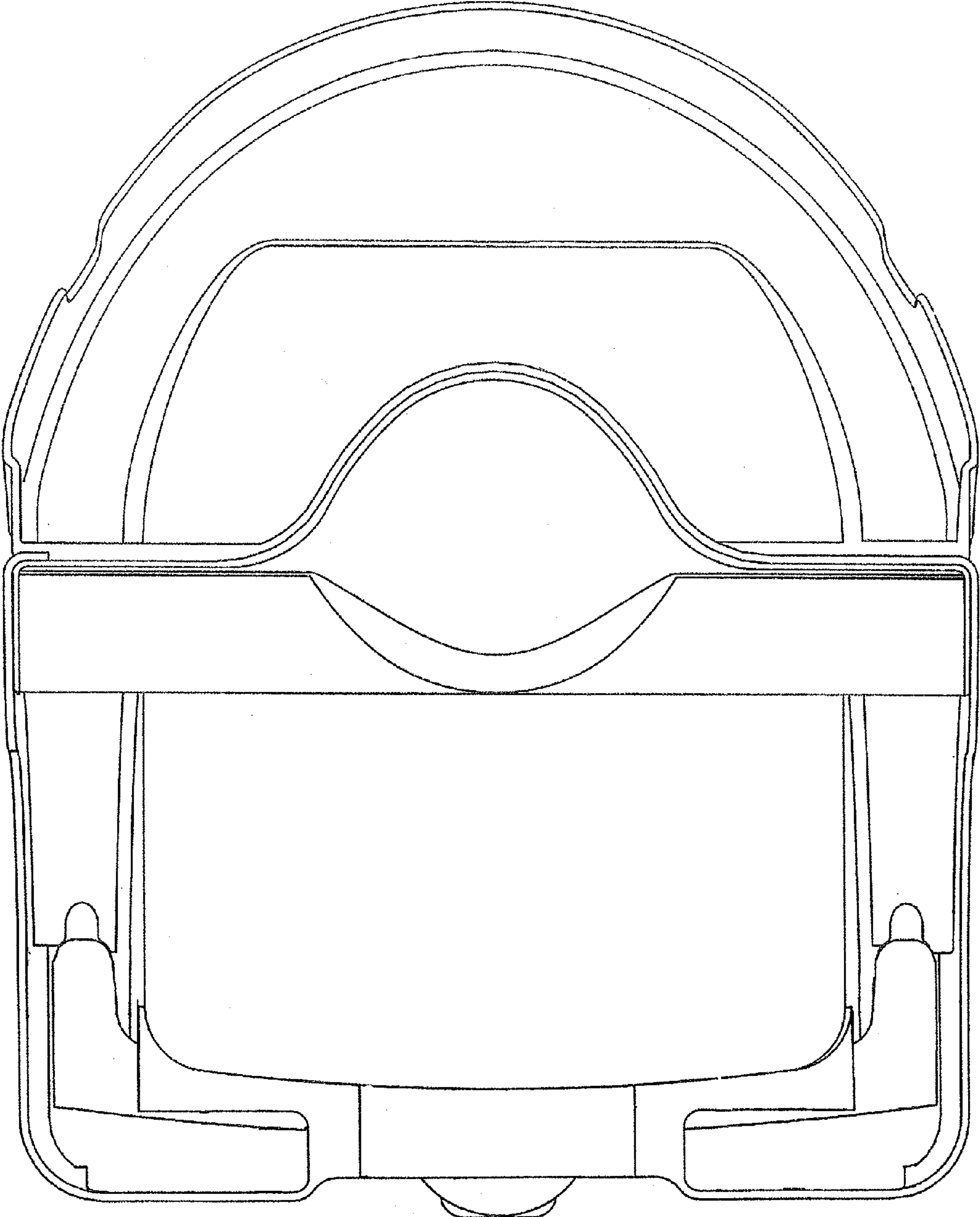

FIG. 3

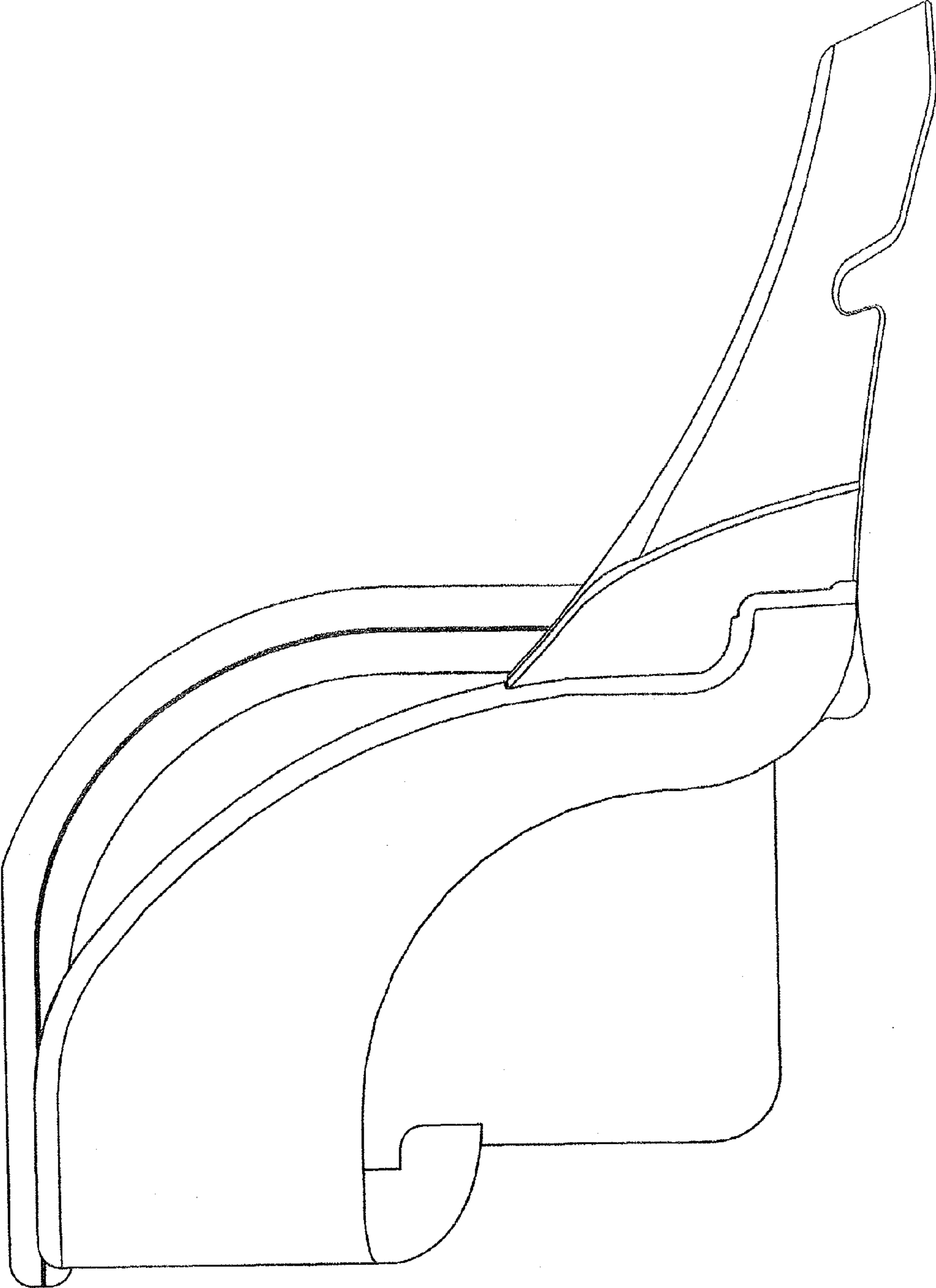

FIG. 4

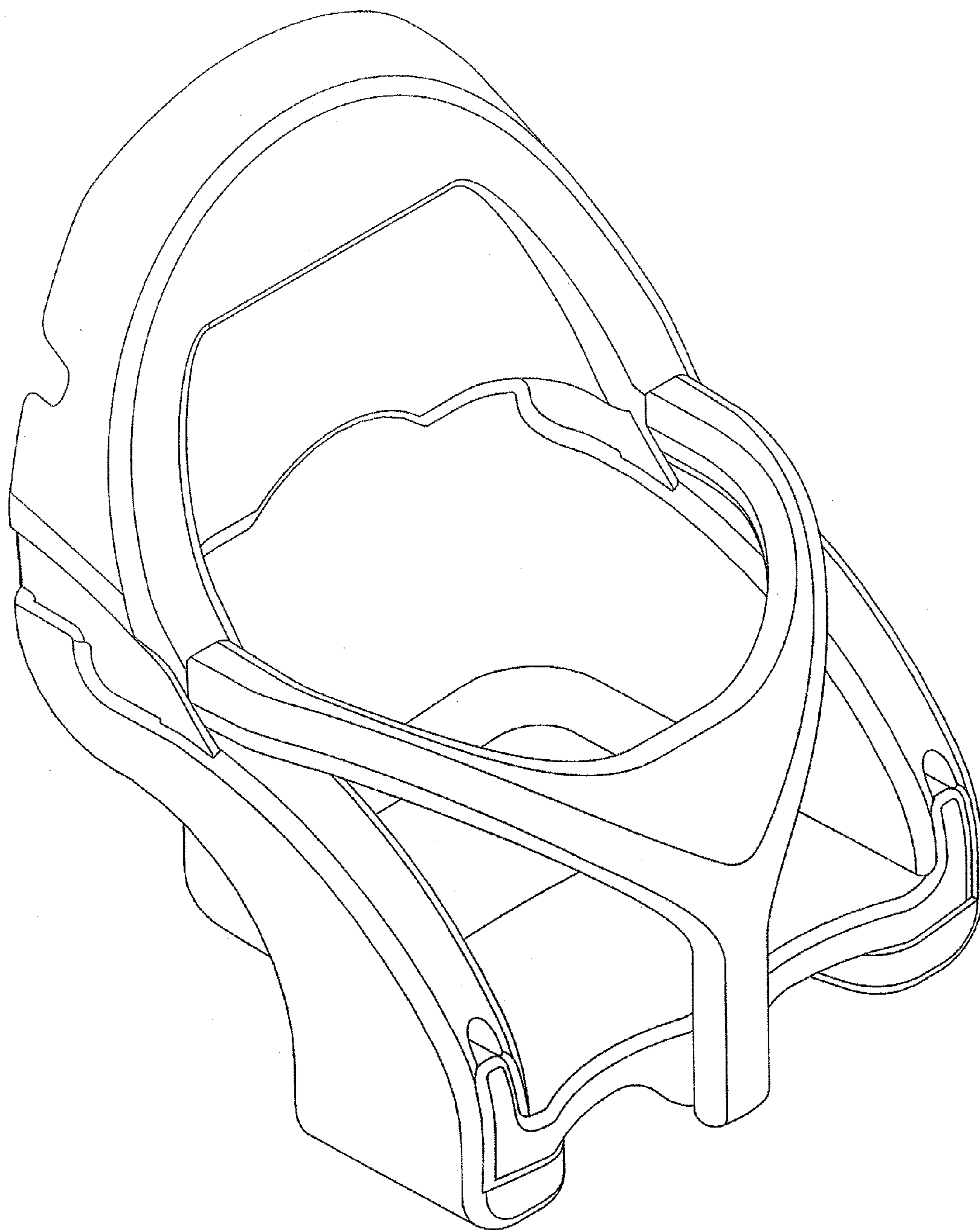

FIG. 5

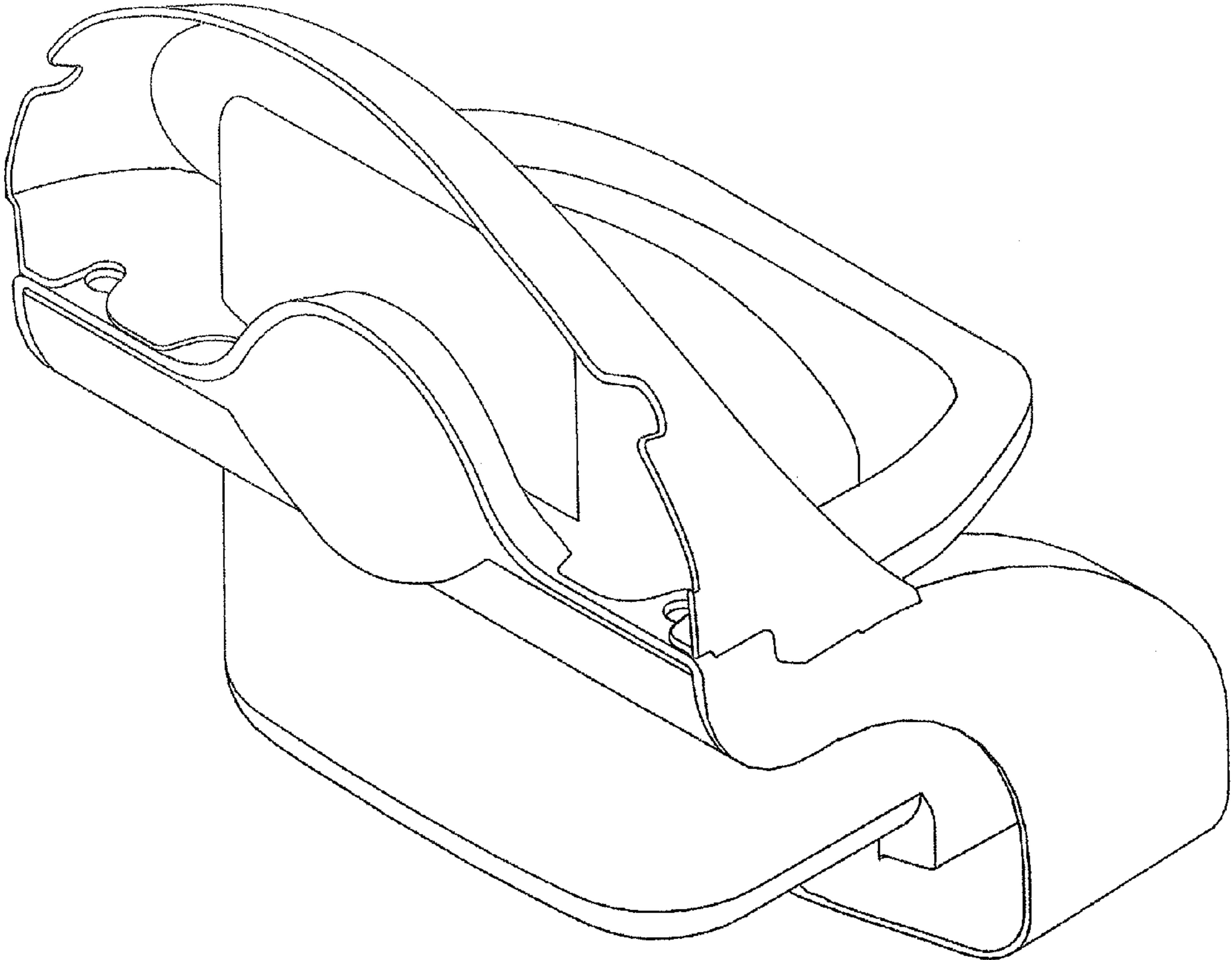

FIG. 6

UNITED STATES PATENT AND TRADEMARK OFFICE
CERTIFICATE OF CORRECTION

PATENT NO. : D616,653 S
APPLICATION NO. : 29/322474
DATED : June 1, 2010
INVENTOR(S) : Miles Mann

Page 1 of 1

It is certified that error appears in the above-identified patent and that said Letters Patent is hereby corrected as shown below:

Title page, item [73] Assignee:

should read as follows: Tube Plastics Limited, Strourport-On-Severn, Worcestershire (GB)

Signed and Sealed this
Twentieth Day of December, 2011

A handwritten signature in black ink that reads "David J. Kappos". The signature is written in a cursive style with a large initial "D" and "K".

David J. Kappos
Director of the United States Patent and Trademark Office