



US00D616603S

(12) **United States Design Patent**  
**Chuan**

(10) **Patent No.:** **US D616,603 S**

(45) **Date of Patent:** **\*\* May 25, 2010**

(54) **LIGHTER**

(76) **Inventor:** **Chin-Chung Chuan**, No.13, Alley 41,  
Lane 8, Tainmu E.Rd., Shihlin District,  
Taipei City 111 (TW)

(\*\*) **Term:** **14 Years**

(21) **Appl. No.:** **29/335,263**

(22) **Filed:** **Apr. 12, 2009**

(51) **LOC (9) Cl.** ..... **27-02**

(52) **U.S. Cl.** ..... **D27/139; D27/141; D27/154**

(58) **Field of Classification Search** ..... D27/139,  
D27/141, 144, 147, 153, 154-160; 431/129-153,  
431/253-257, 273-277

See application file for complete search history.

(56) **References Cited**

**U.S. PATENT DOCUMENTS**

D435,933 S \* 1/2001 Chen ..... D27/141  
D451,635 S \* 12/2001 Smith ..... D27/143  
D463,617 S \* 9/2002 Park ..... D27/157  
6,632,082 B1 \* 10/2003 Smith ..... 431/152

6,875,013 B2 \* 4/2005 Smith ..... 431/253  
D515,735 S \* 2/2006 Smith ..... D27/157  
D537,198 S \* 2/2007 Chuang ..... D27/143  
D592,802 S \* 5/2009 Chuan ..... D27/154

\* cited by examiner

*Primary Examiner*—Dominic Simone  
(74) *Attorney, Agent, or Firm*—Banger Shia

(57) **CLAIM**

The ornamental design for a lighter, as shown and described.

**DESCRIPTION**

FIG. 1 is a perspective view of a lighter showing my new design;

FIG. 2 is a front elevational view thereof;

FIG. 3 is a rear elevational view thereof;

FIG. 4 is a left side elevational view thereof;

FIG. 5 is a right side elevational view thereof;

FIG. 6 is a top plan view thereof; and,

FIG. 7 is a bottom plan view thereof.

**1 Claim, 4 Drawing Sheets**

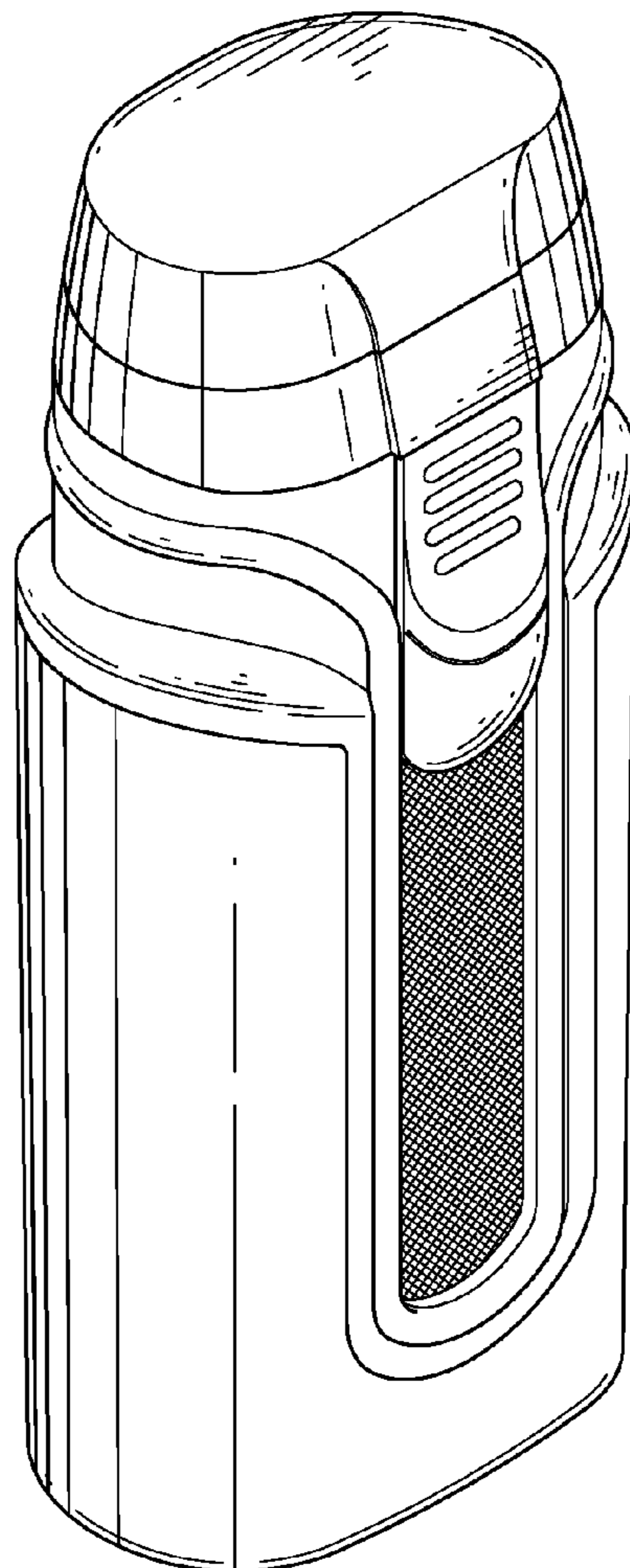

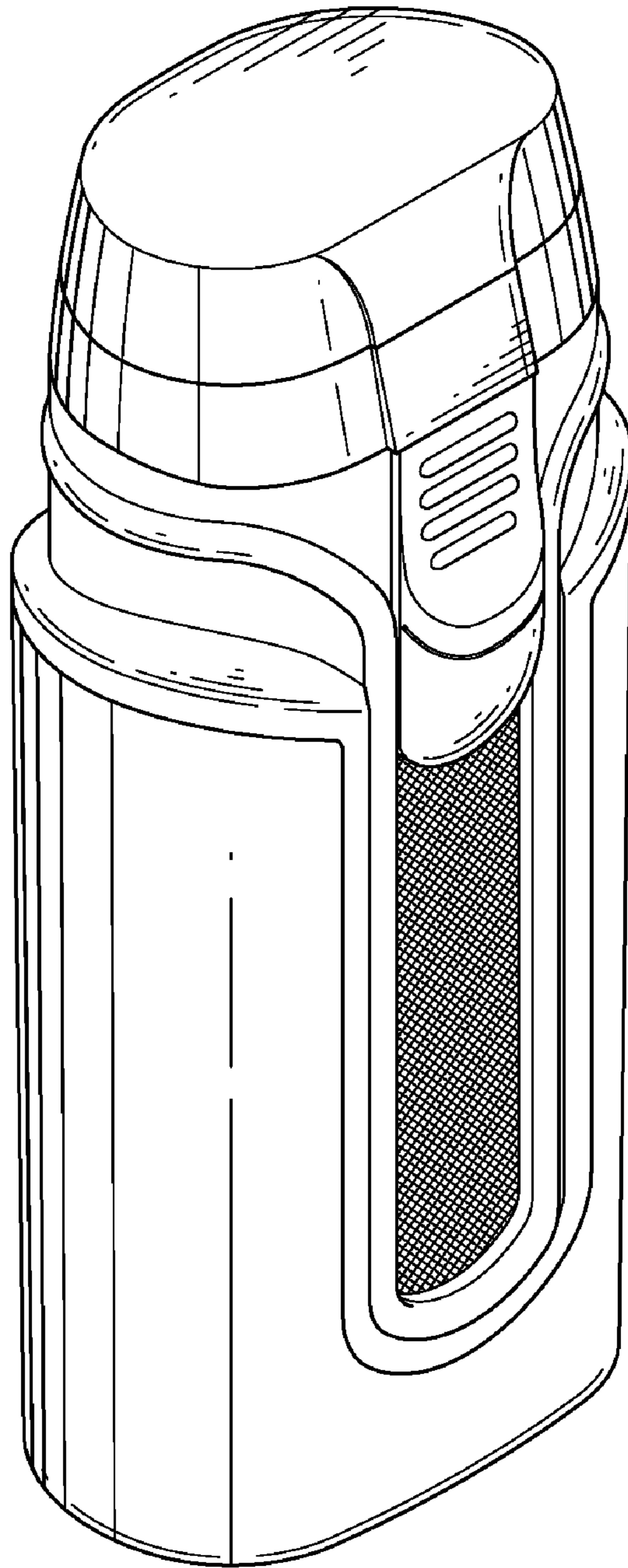

FIG. 1

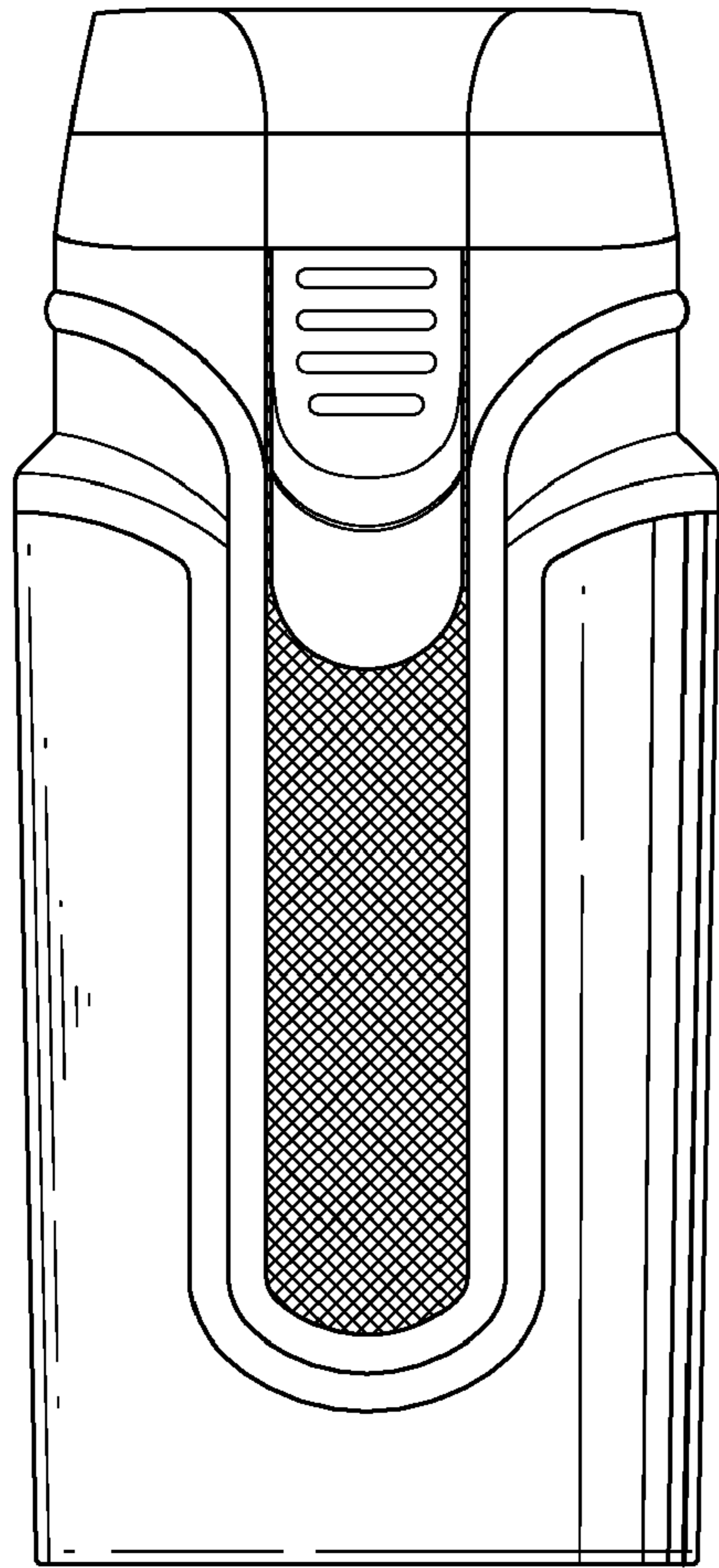

FIG. 2

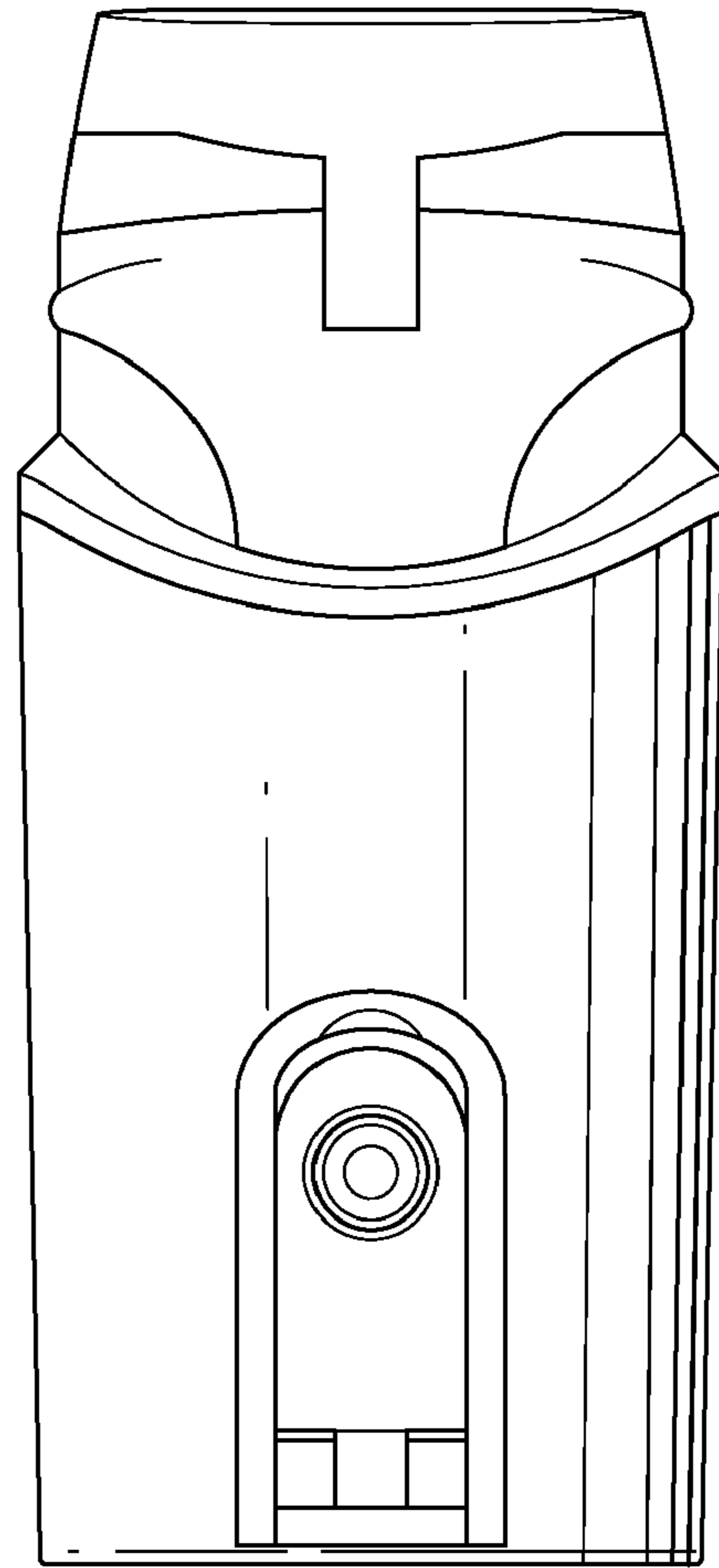

FIG. 3

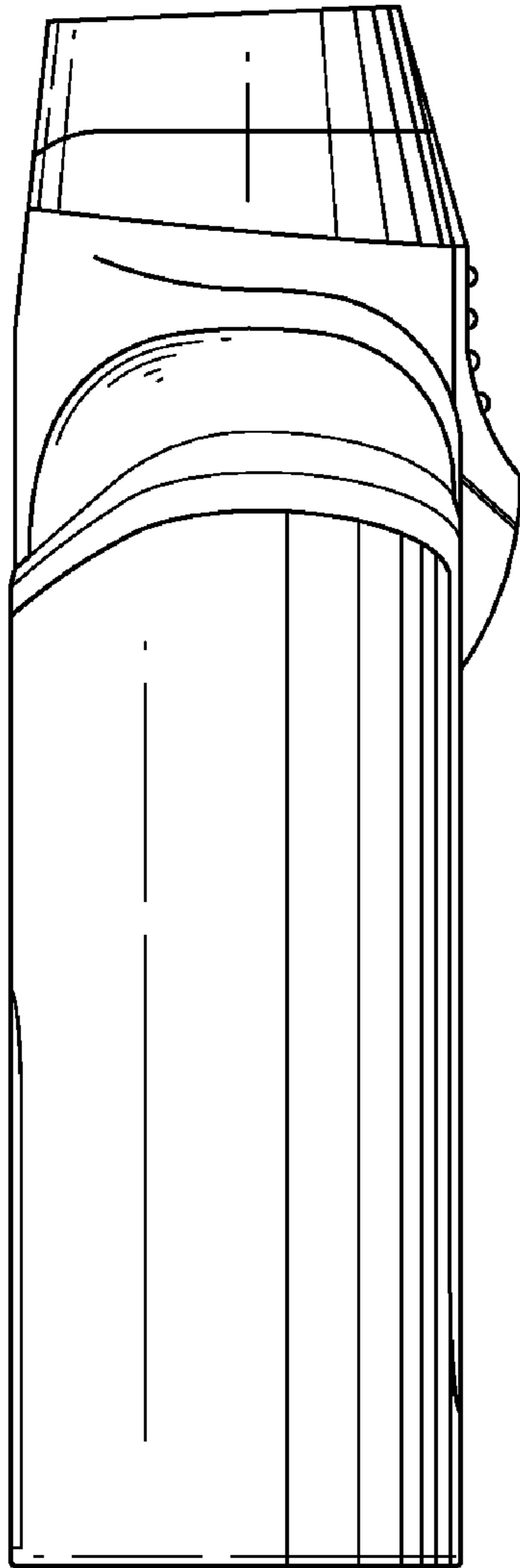

FIG. 4

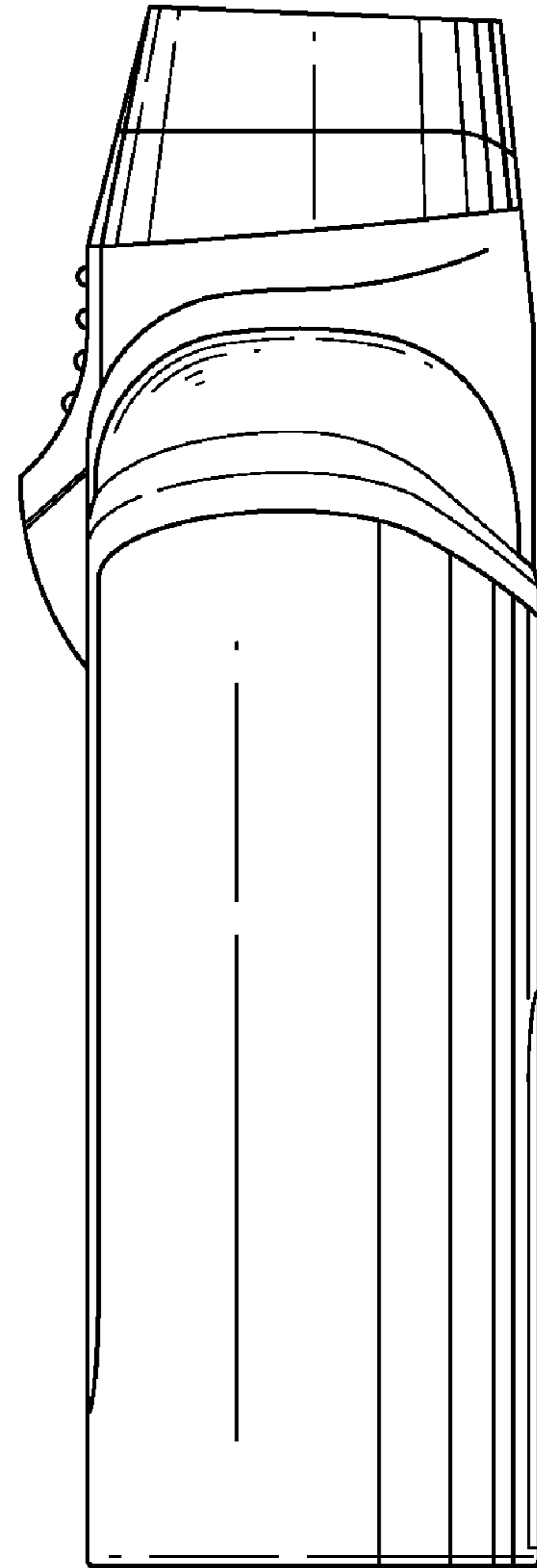

FIG. 5

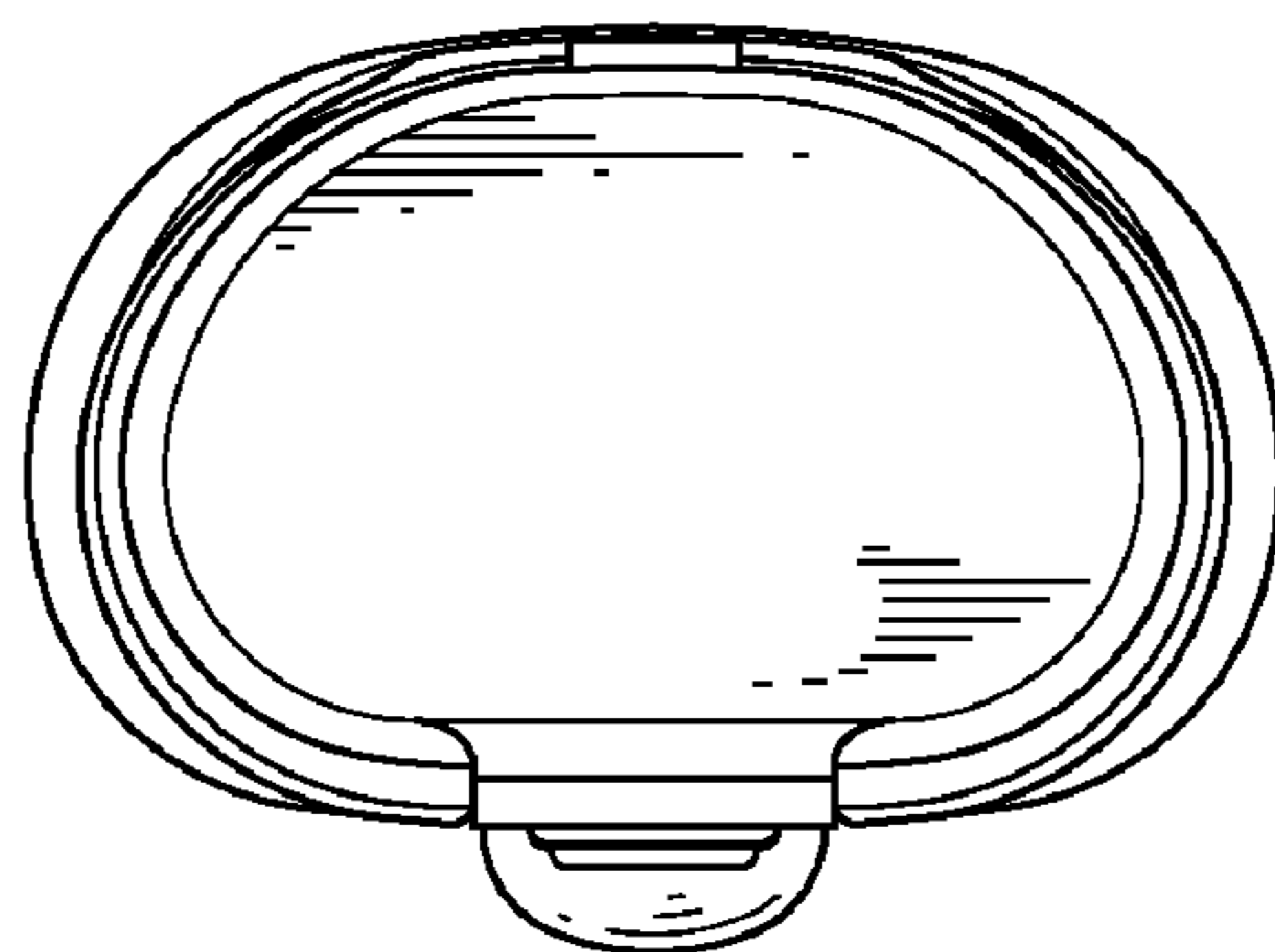

FIG. 6

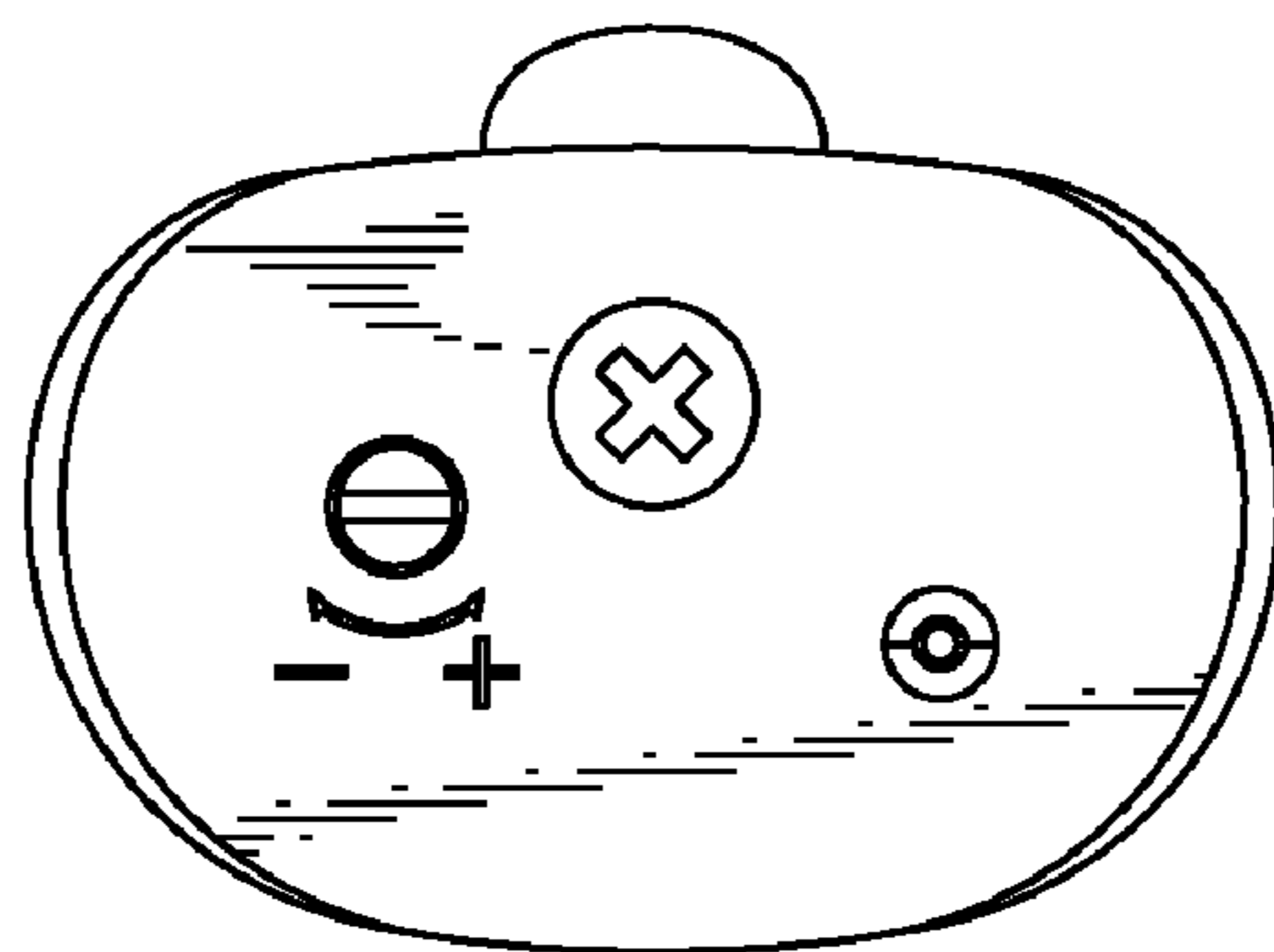

FIG. 7