



US00D616594S

(12) **United States Design Patent**
Meeker et al.

(10) **Patent No.:** **US D616,594 S**

(45) **Date of Patent:** **** *May 25, 2010**

(54) **BASE FOR LUMINARY**

(75) Inventors: **Shane Edwin Meeker**, South Lebanon, OH (US); **Michael Thomas Seum**, Cincinnati, OH (US); **Philip Edwin Hague**, Chicago, IL (US); **Jason Craig Campbell**, Chicago, IL (US)

(73) Assignee: **The Procter & Gamble Company**, Cincinnati, OH (US)

(*) Notice: This patent is subject to a terminal disclaimer.

(**) Term: **14 Years**

(21) Appl. No.: **29/301,959**

(22) Filed: **Mar. 25, 2008**

(51) **LOC (9) Cl.** **26-03**

(52) **U.S. Cl.** **D26/93; D26/101**

(58) **Field of Classification Search** D26/93-126; D25/32, 37, 57, 62; 382/118-127, 317, 362, 382/410-415, 806; D11/142-145, 155, 157, D11/131

See application file for complete search history.

(56) **References Cited**

U.S. PATENT DOCUMENTS

4,149,525 A 4/1979 Prado

(Continued)

OTHER PUBLICATIONS

Found on p. 87 of a Mar. 31, 1996 Japanese catalogue called "Made for Export."

(Continued)

Primary Examiner—Brian N Vinson

(74) *Attorney, Agent, or Firm*—Julia A. Glazer; Kim W. Zerby; Steven W. Miller

(57) **CLAIM**

The ornamental design for a base for luminary, as shown and described.

DESCRIPTION

FIG. 1 is a perspective view showing a first embodiment of our new design.

FIG. 2 is a left side view of the design of FIG. 1.

FIG. 3 is a right side view of the design of FIG. 1.

FIG. 4 is a front view of the design of FIG. 1.

FIG. 5 is a rear view of the design of FIG. 1.

FIG. 6 is a top view of the design of FIG. 1.

FIG. 7 is a bottom view of the design of FIG. 1.

FIG. 8 is a perspective view of a second embodiment of our new design.

FIG. 9 is a left side view of the design of FIG. 8.

FIG. 10 is a right side view of the design of FIG. 8.

FIG. 11 is a front view of the design of FIG. 8.

FIG. 12 is a rear view of the design of FIG. 8.

FIG. 13 is a top view of the design of FIG. 8; and,

FIG. 14 is a bottom view of the design of FIG. 8.

The broken-line disclosure in the views is understood to represent portions of the article in which the claimed design is embodied, but which do not comprise part of the claimed design. Where a broken-line abuts a claimed surface, that broken line is understood to indicate either an unclaimed edge or an unclaimed boundary between claimed and unclaimed surfaces.

1 Claim, 10 Drawing Sheets

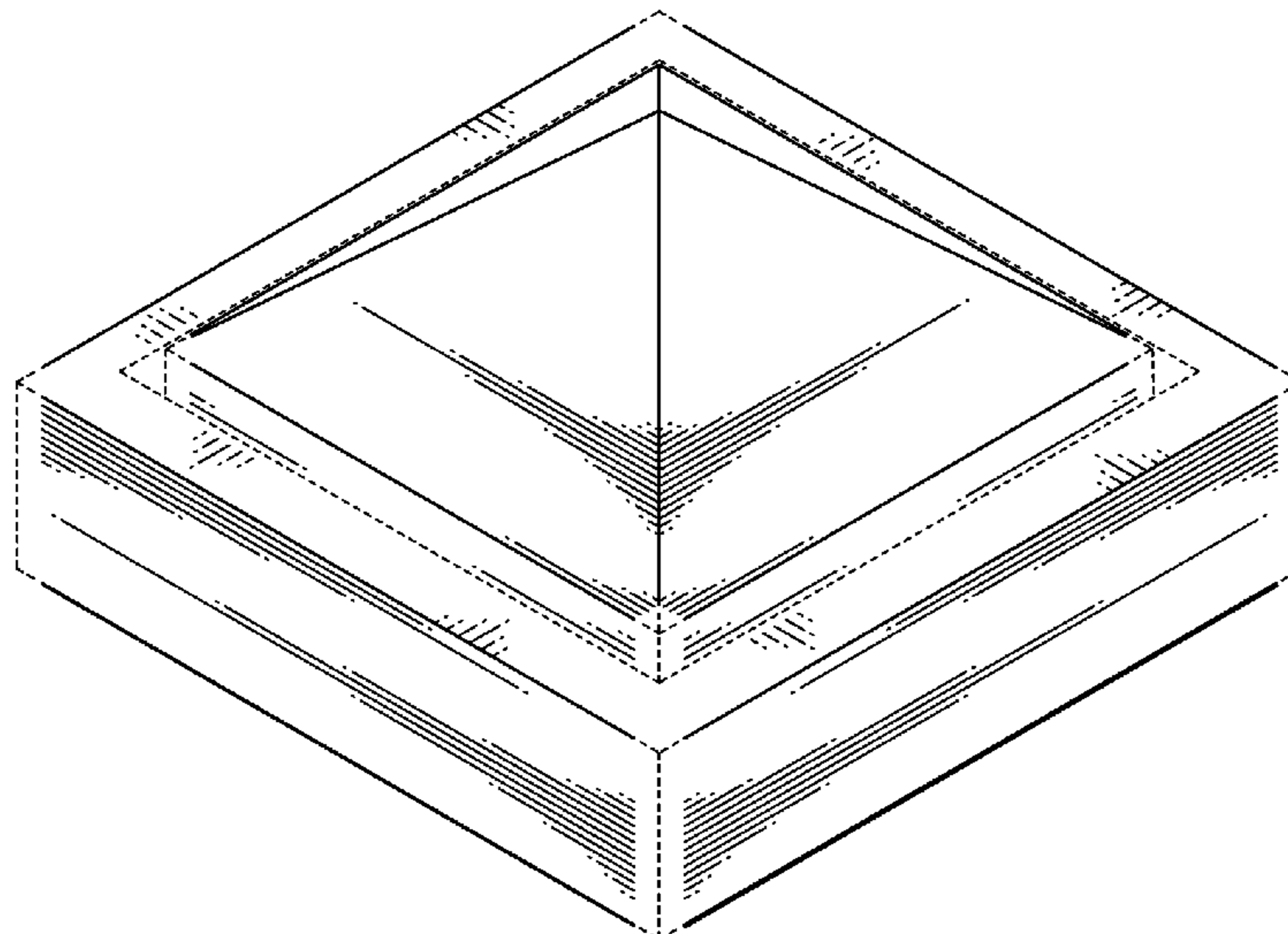

US D616,594 S

Page 2

U.S. PATENT DOCUMENTS

4,754,380 A * 6/1988 Wang D26/93
D369,572 S * 5/1996 Buck et al. D11/131
D383,864 S * 9/1997 Billings D26/51
D561,929 S 2/2008 Meeker et al.
D565,239 S 3/2008 Meeker et al.
D565,783 S 4/2008 Meeker et al.

OTHER PUBLICATIONS

From the website of the Fern Group, Ltd. Of Toronto, Canada, web
address: <http://www.ferngroup.com/index>.

[php?option=com_virtuemart&Itemid=43](http://www.ferngroup.com/index), downloaded on Aug. 28,
2008, 2 pages.

European Registered Community Design EM806021-0022 regis-
tered on Oct. 10, 2007 and owned by Lorefar S.L.U. of Barcelona
Spain.

U.S. Appl. No. 29/301,961, filed Mar. 25, 2008, Shane Edwin
Meeker, et al.

U.S. Appl. No. 29/301,960, filed Mar. 25, 2008, Shane Edwin
Meeker, et al.

* cited by examiner

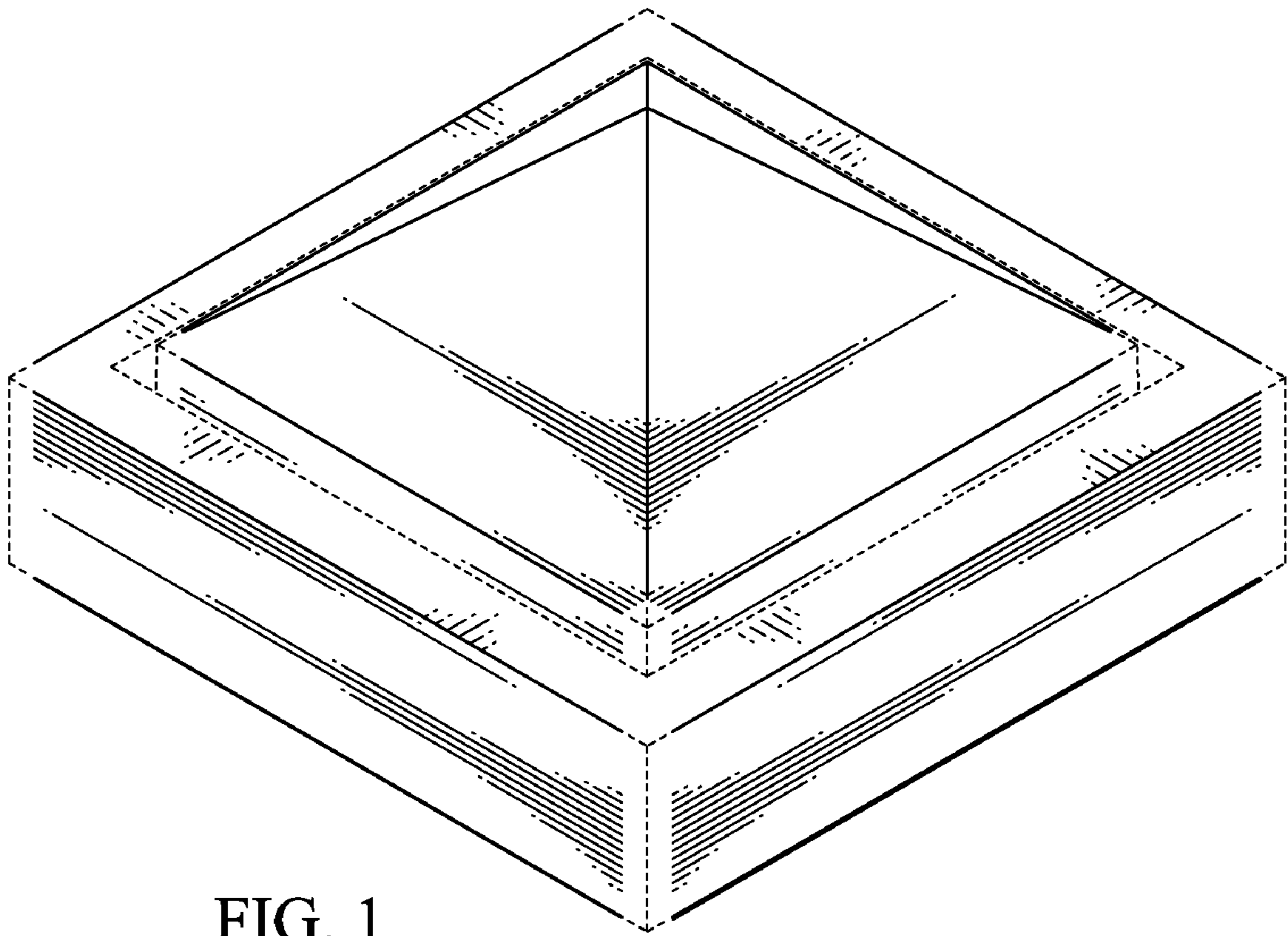

FIG. 1

FIG. 2

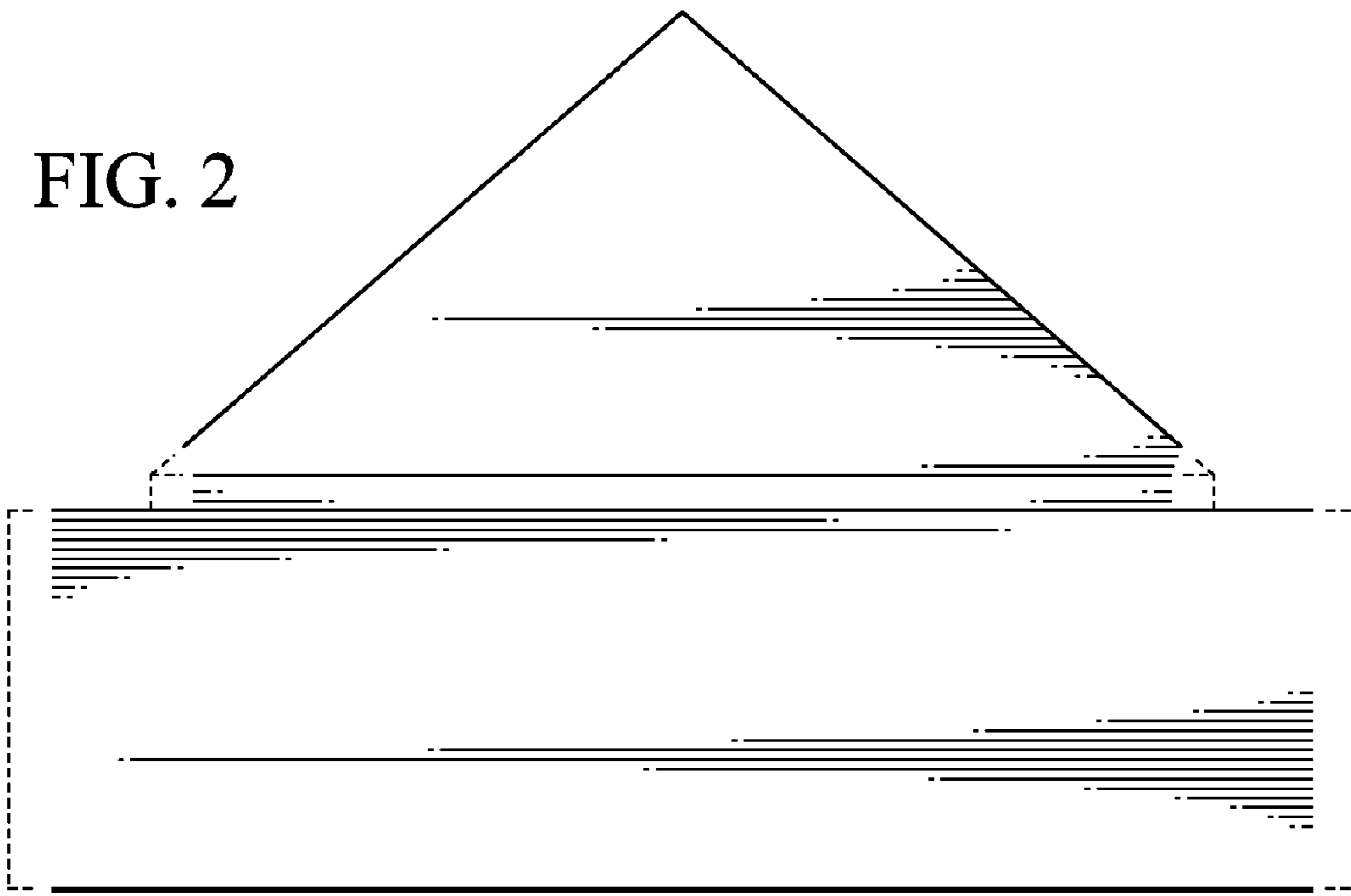
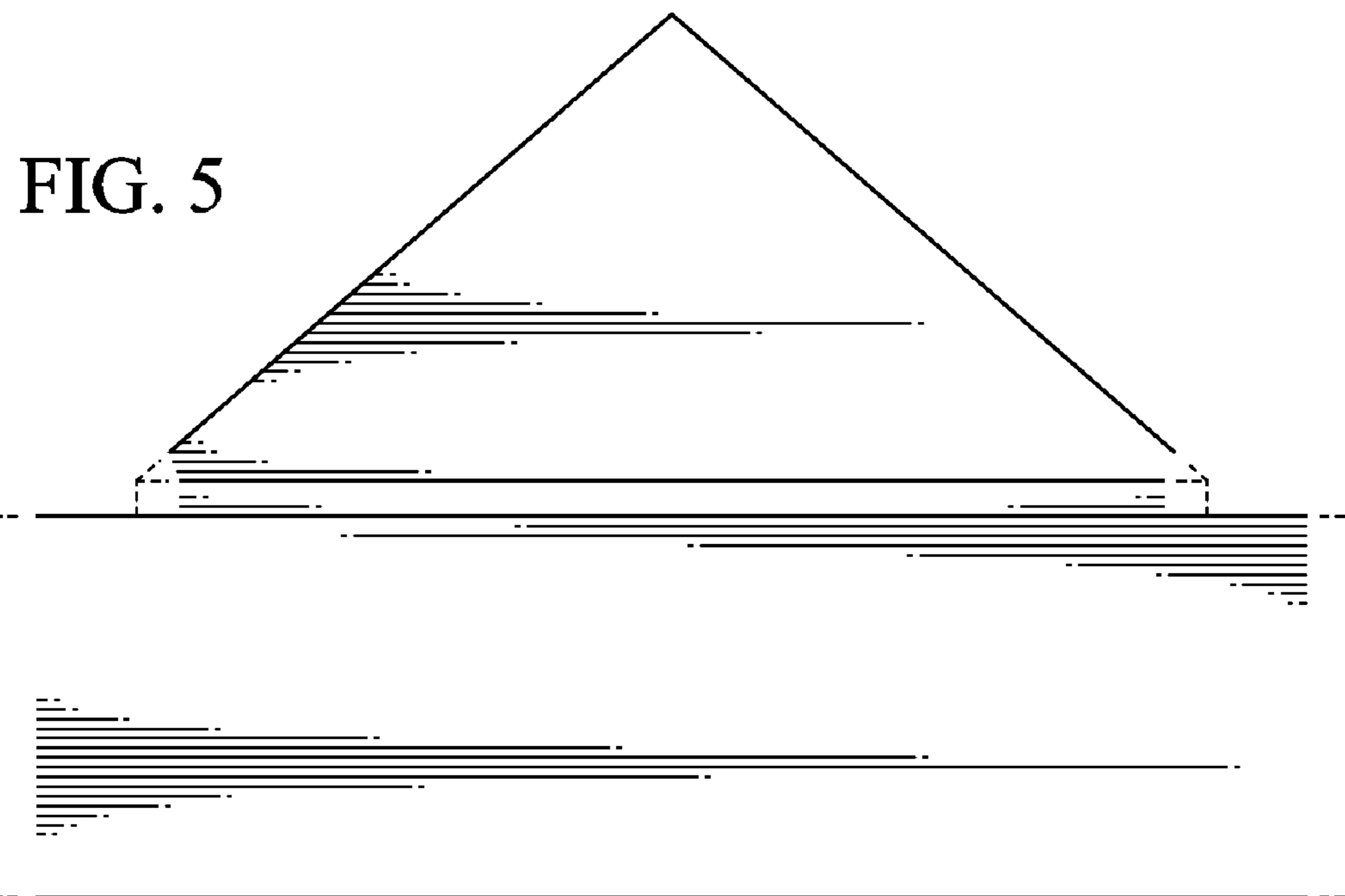
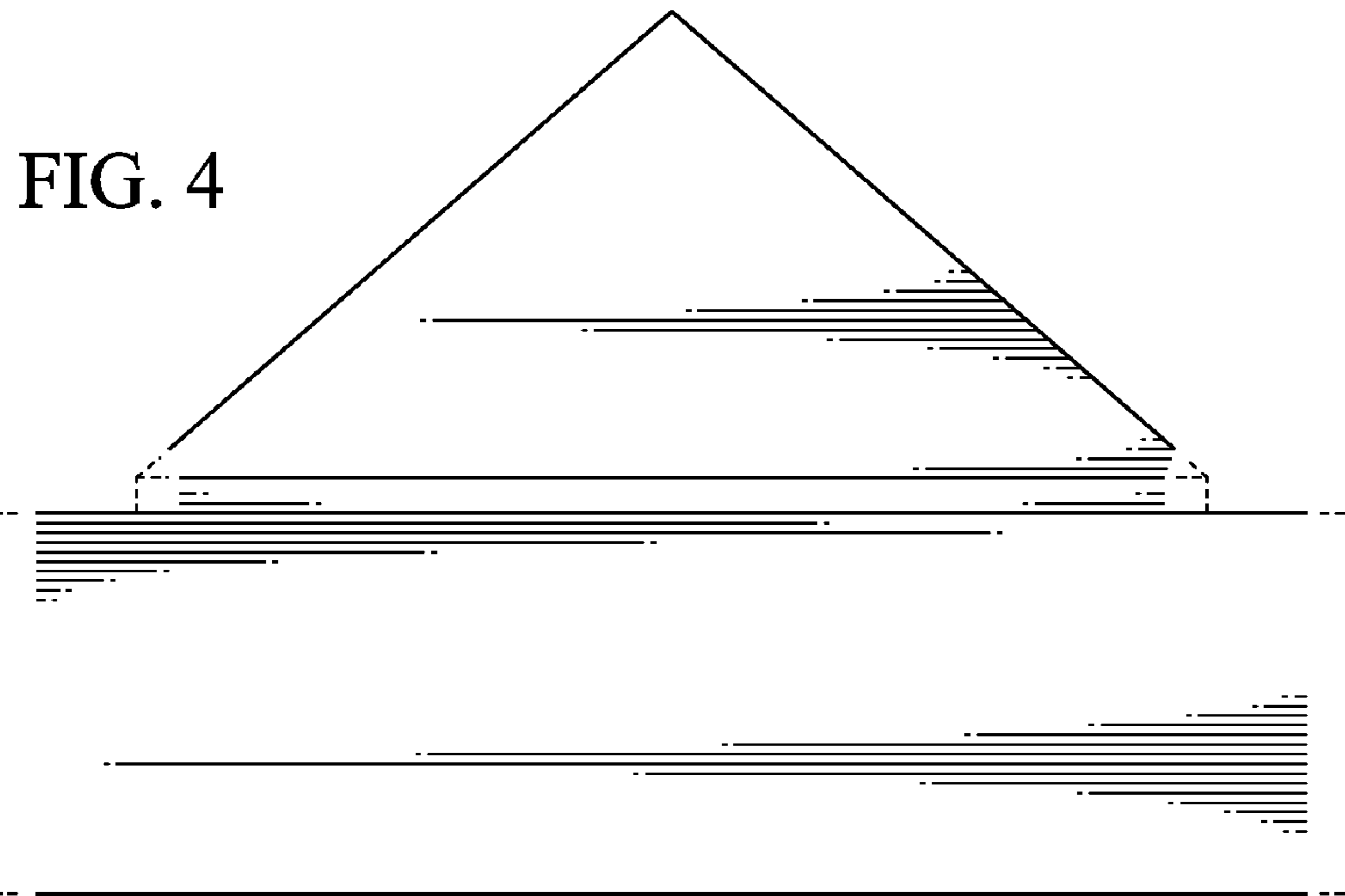

FIG. 3





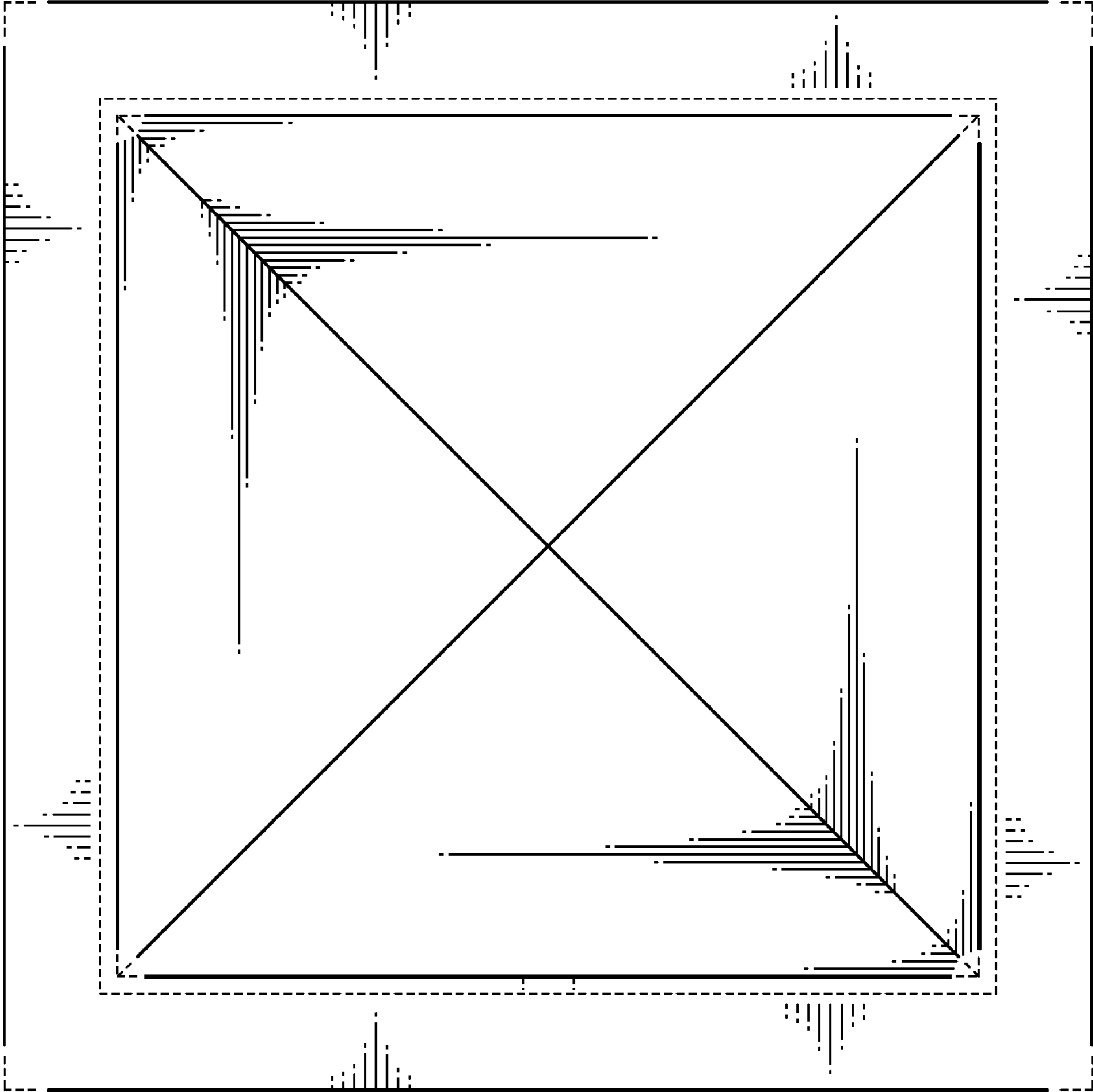

FIG. 6

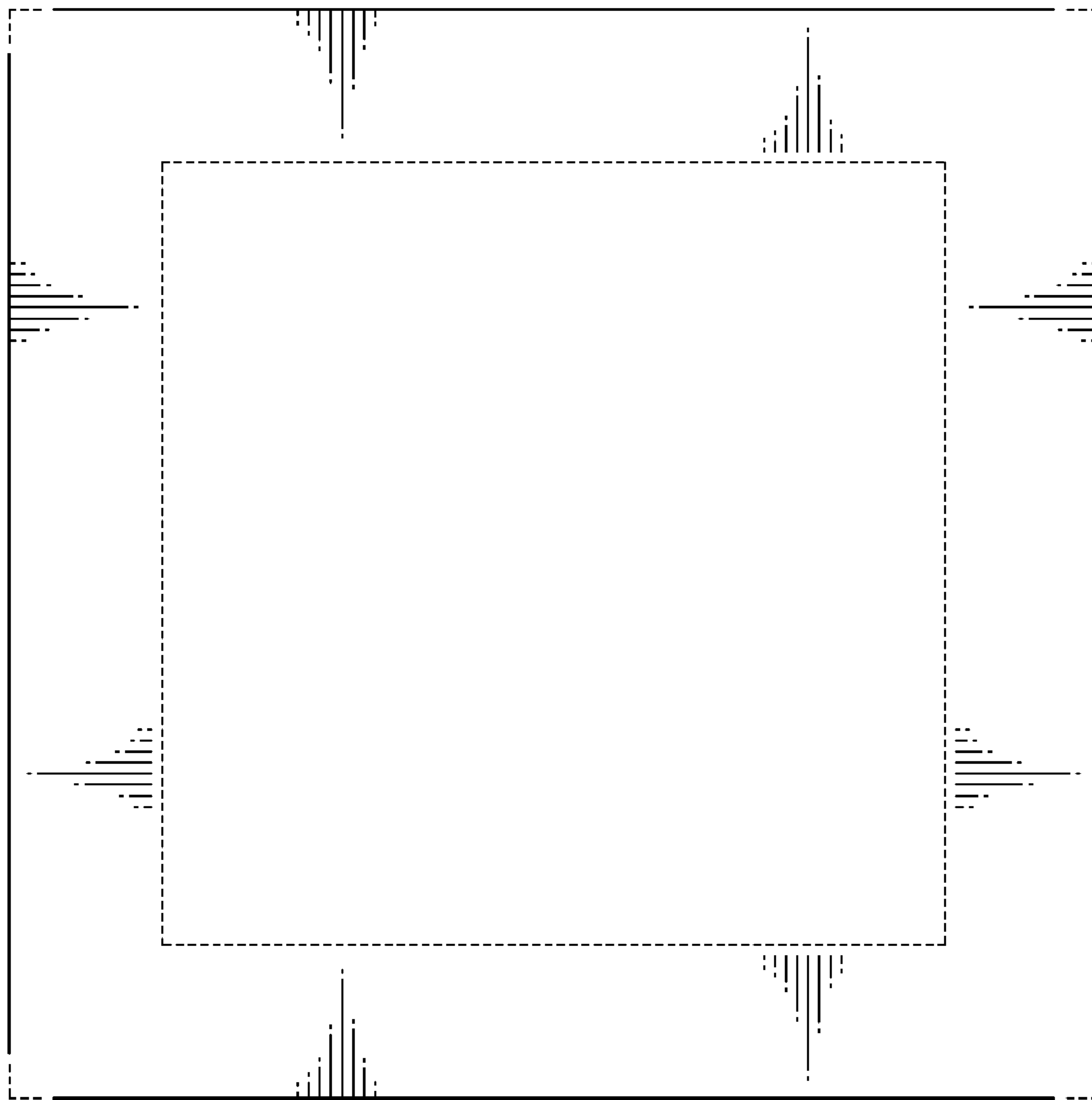

FIG. 7

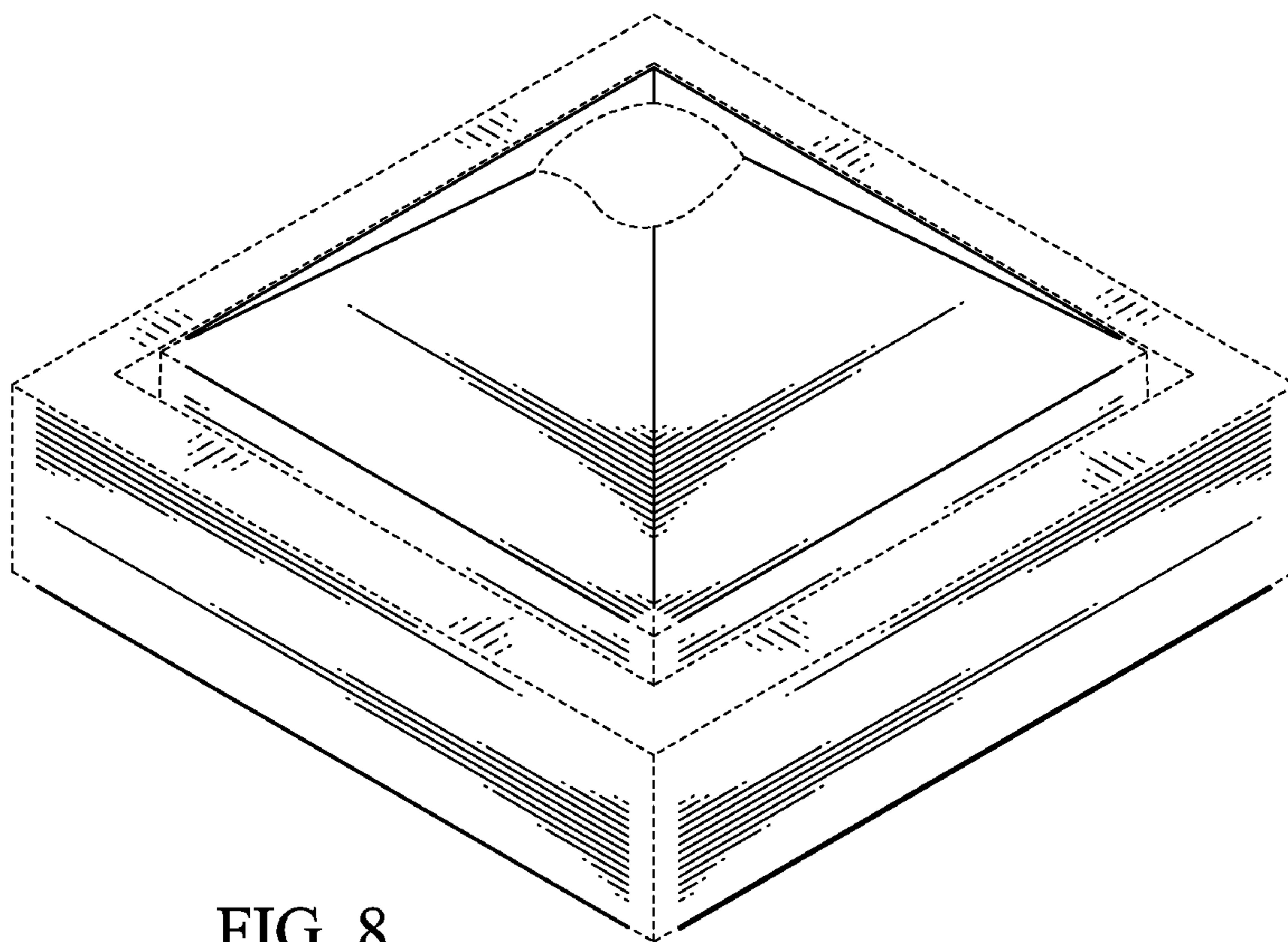

FIG. 8

FIG. 9

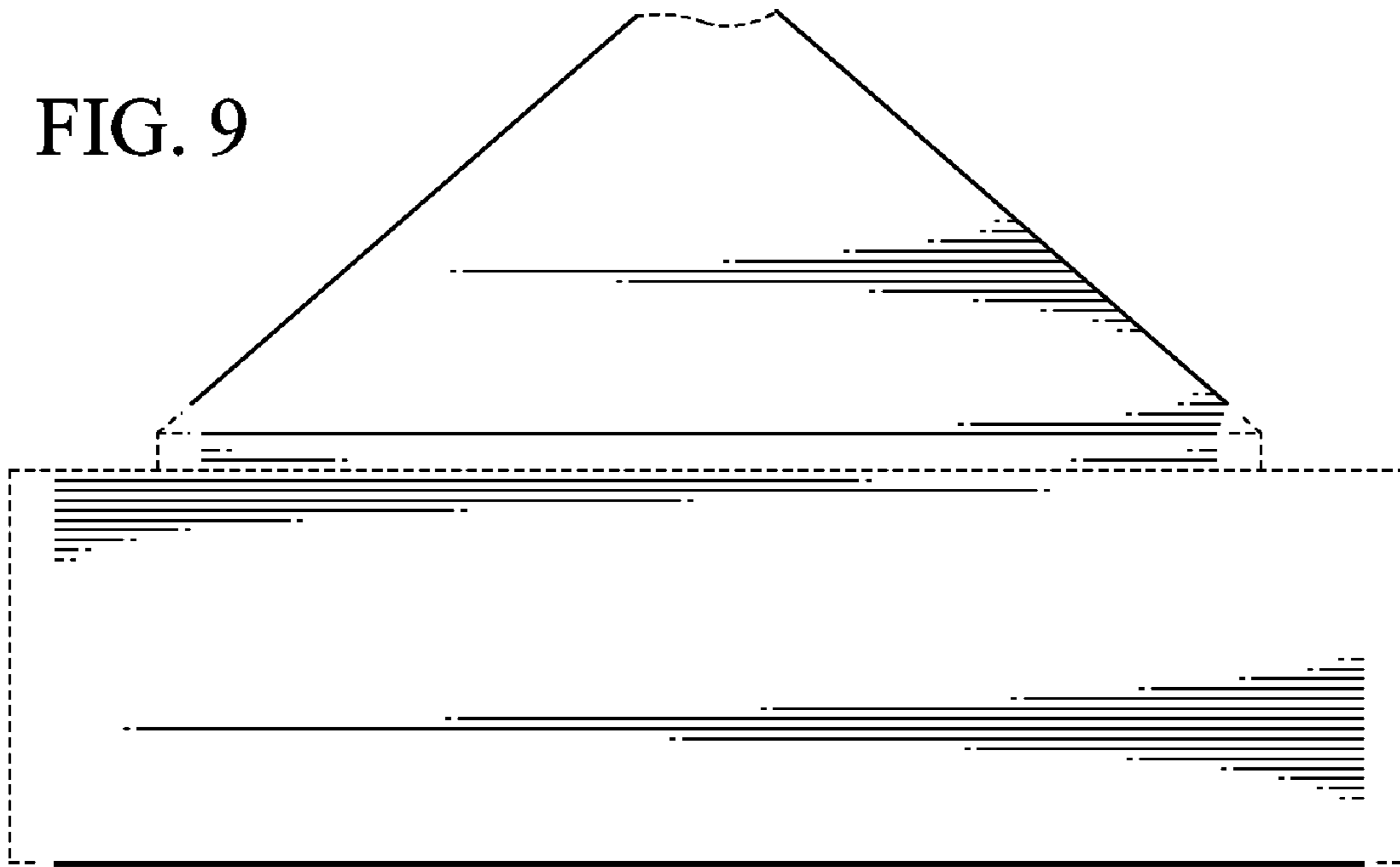

FIG. 10

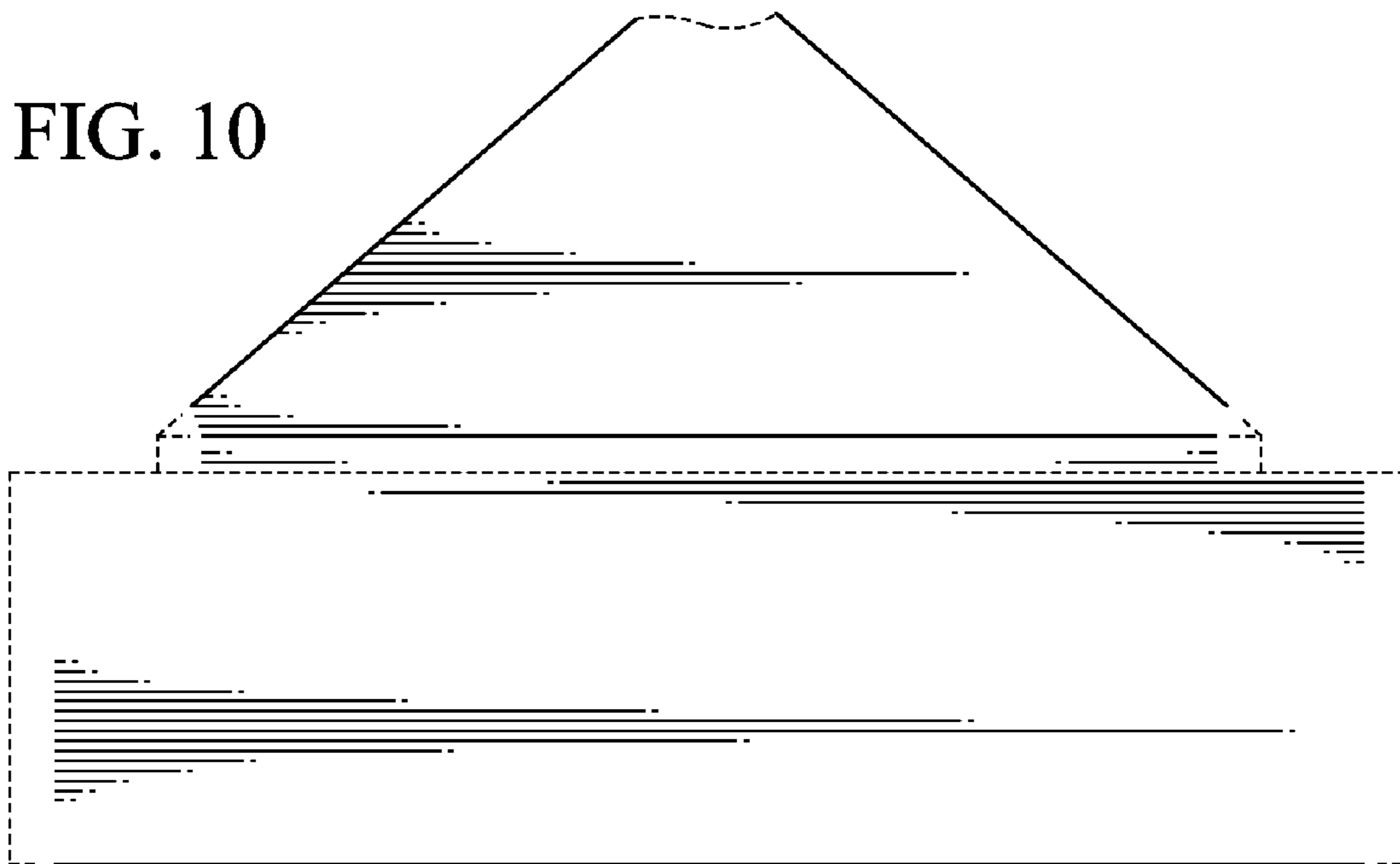

FIG. 11

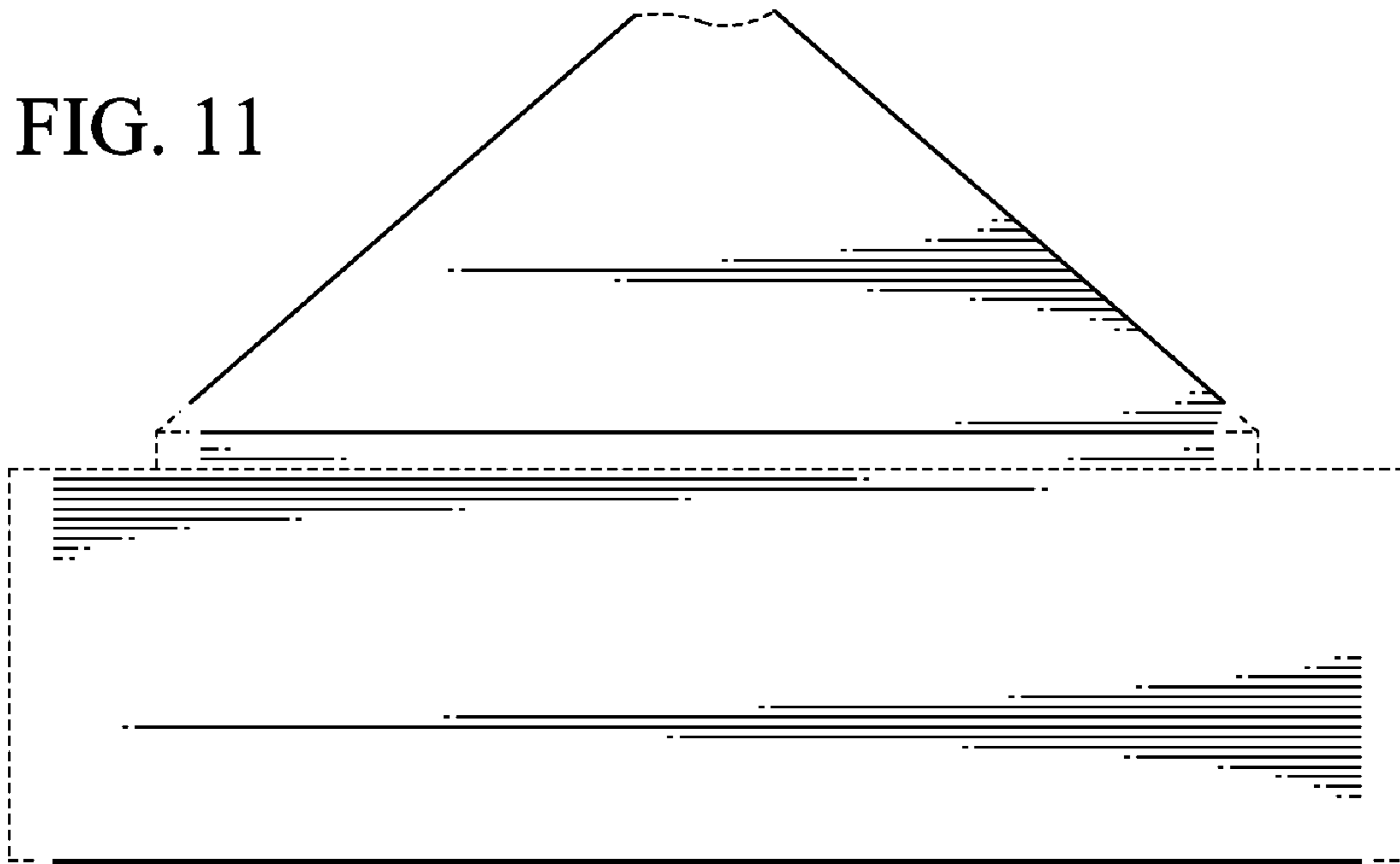
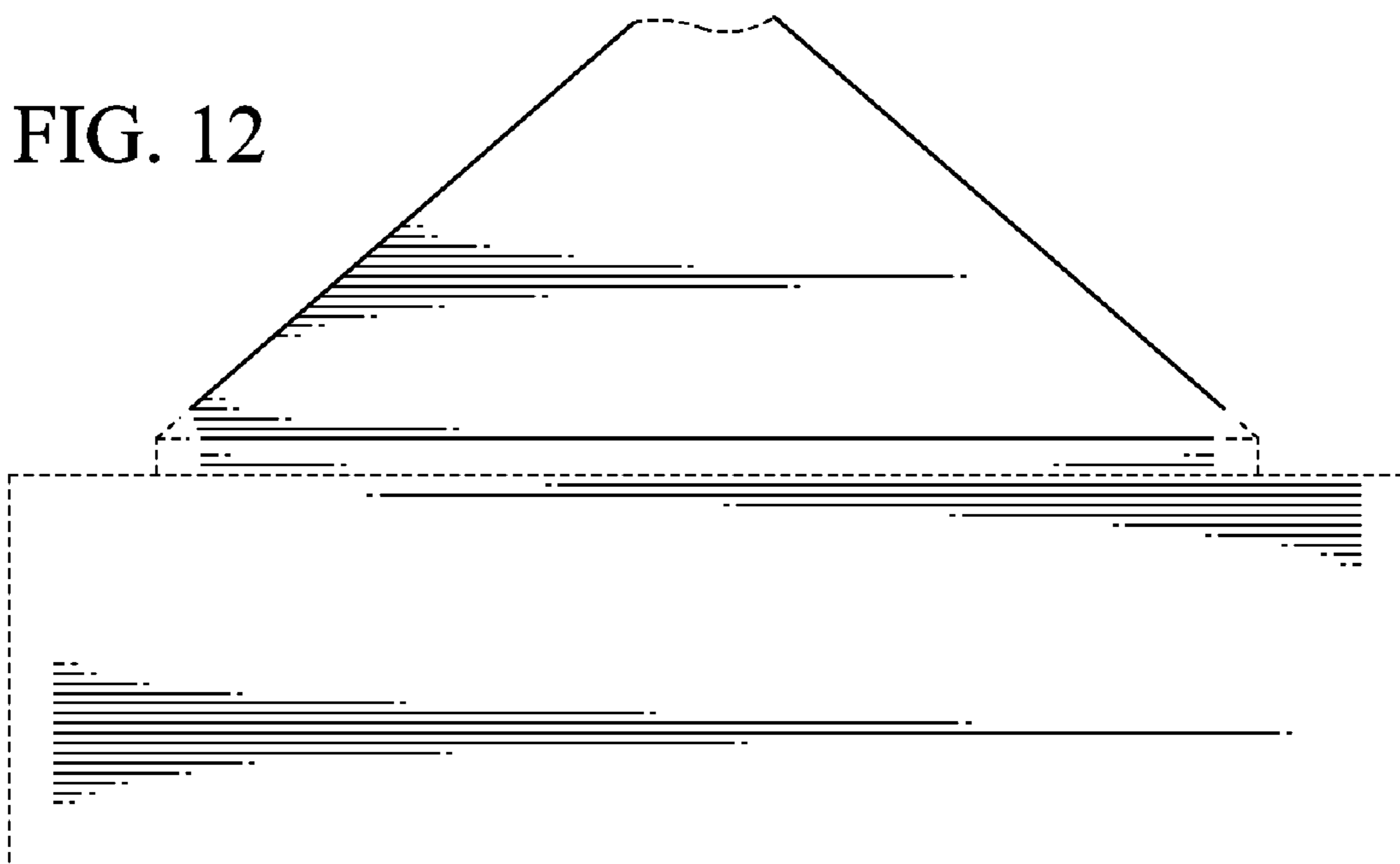

FIG. 12



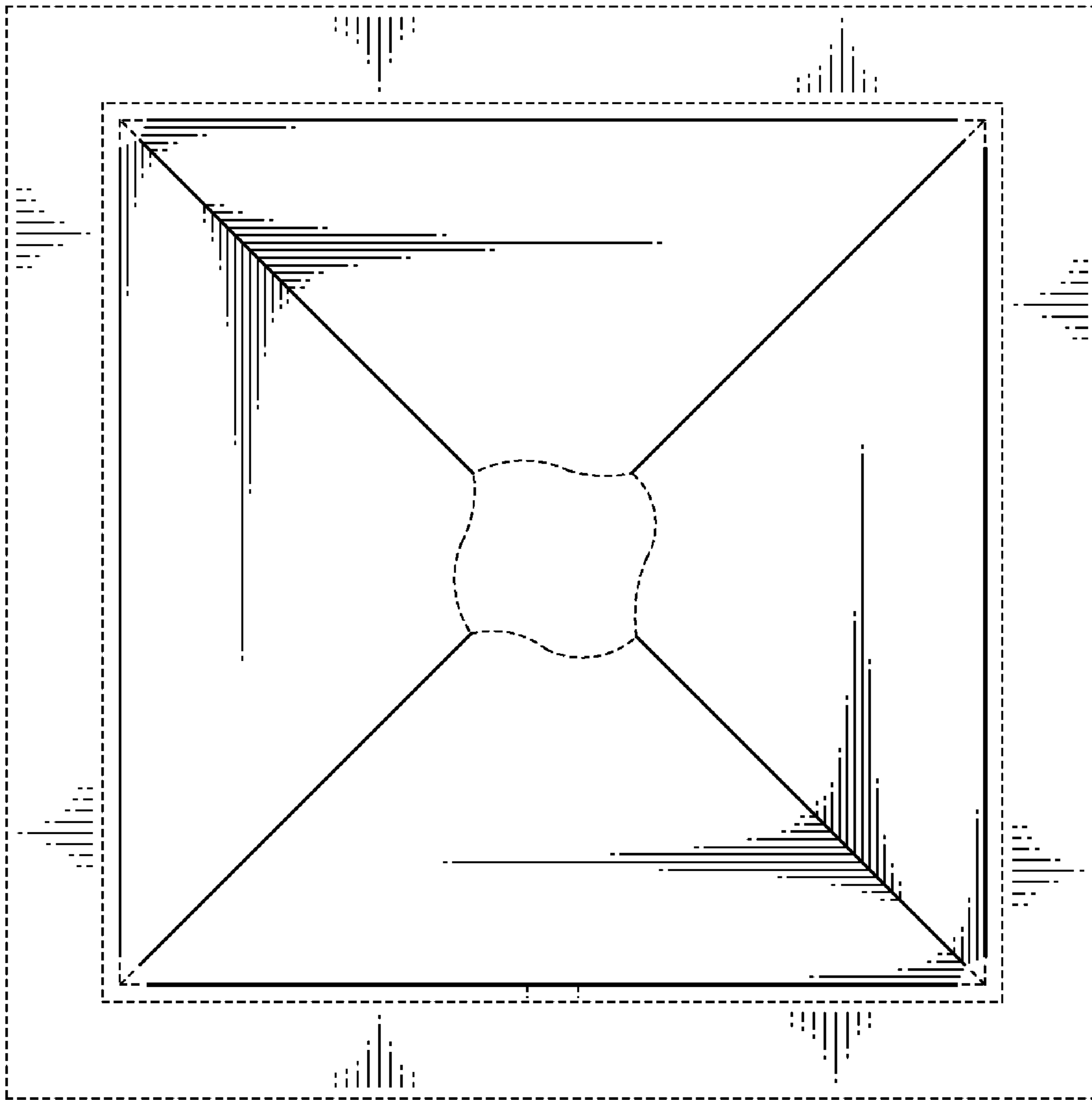

FIG. 13

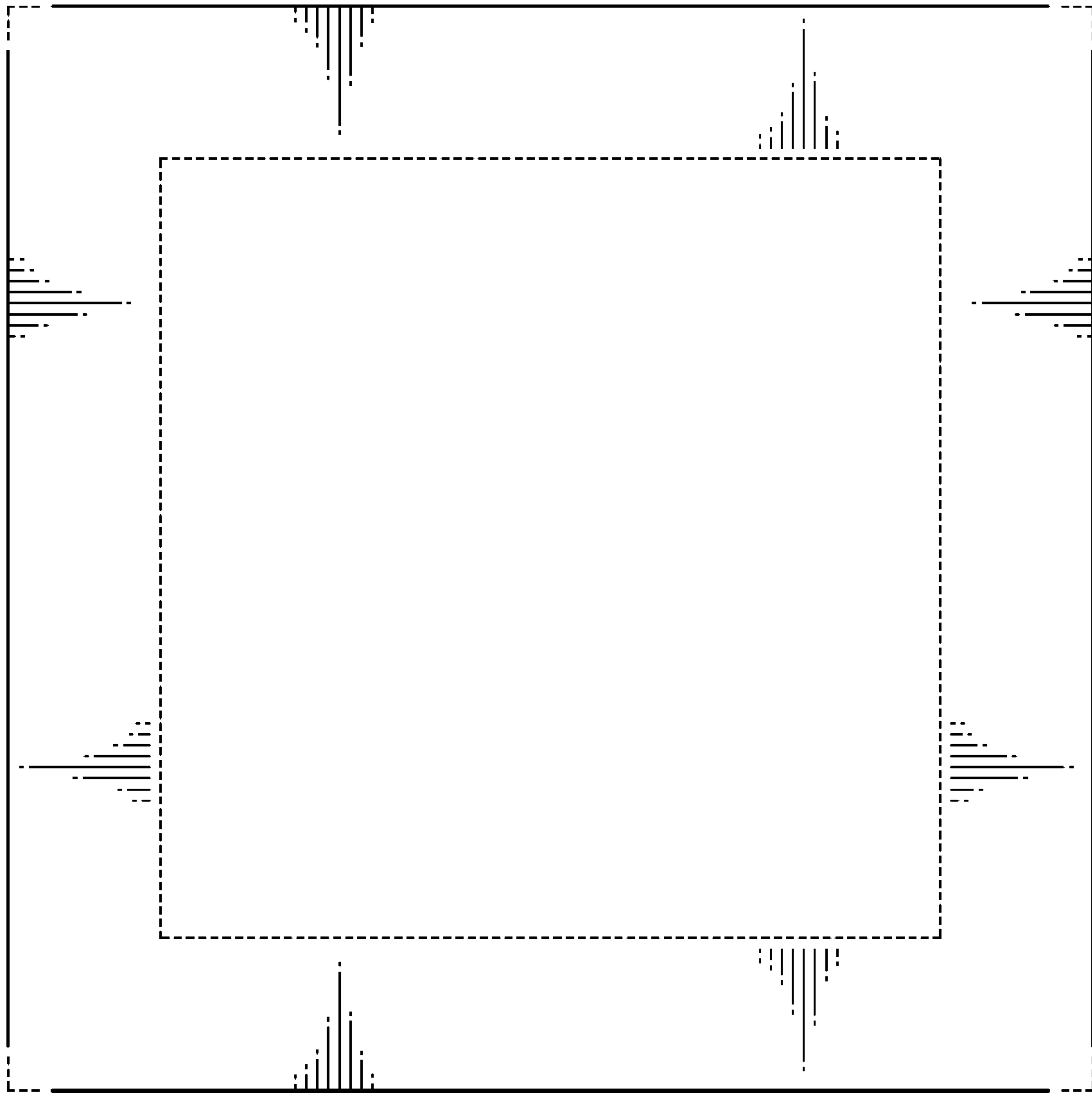

FIG. 14