



US00D616493S

(12) **United States Design Patent**  
**Burge et al.**

(10) **Patent No.:** **US D616,493 S**

(45) **Date of Patent:** **\*\* May 25, 2010**

(54) **MAGNETIC BOOKMARK**

(75) Inventors: **Pamela Andrews Burge**, Destin, FL (US); **Frank Blaine Burge**, Destin, FL (US); **Ma-Lie Chung Lo**, Mountain Lake, NJ (US)

(73) Assignee: **Andrews + Blaine, Ltd Inc.**, Destin, FL (US)

(\*\*) Term: **14 Years**

(21) Appl. No.: **29/280,061**

(22) Filed: **May 15, 2007**

(51) **LOC (9) Cl.** ..... **19-99**

(52) **U.S. Cl.** ..... **D19/34**

(58) **Field of Classification Search** ..... D19/1, D19/2, 34, 32, 65; D11/78.1, 223; D9/600; D3/253, 247; 116/238, 239, 240, 234, 235; 24/67 R; 281/142; 40/124.01

See application file for complete search history.

(56) **References Cited**

**U.S. PATENT DOCUMENTS**

D30,603 S *	4/1899	Kruttschnitt	.....	D3/247
2,505,743 A *	4/1950	Rose	.....	281/29
D196,099 S *	8/1963	Sibley	.....	D19/27
3,604,067 A *	9/1971	Brown	.....	24/67 R
D282,377 S *	1/1986	Curran	.....	D19/26
D311,209 S *	10/1990	Svee	.....	D19/34
D315,364 S *	3/1991	Scalice et al.	.....	D19/10
D328,470 S *	8/1992	Costello et al.	.....	D19/26
D340,355 S *	10/1993	Little	.....	D3/247
D358,429 S *	5/1995	Ely	.....	D20/27
D365,362 S *	12/1995	Warren	.....	D19/26
D394,387 S *	5/1998	Williams	.....	D9/433
D394,675 S *	5/1998	Haas et al.	.....	D20/27
6,197,396 B1 *	3/2001	Haas et al.	.....	428/40.1

(Continued)

**OTHER PUBLICATIONS**

Sky-Gifts Bookmark <http://web.archive.org/web/20060808201804/sky-gifts.com/Corporate/Picture/1-Corporate+Gifts/MB004-Mag+Bkmark.jpg> Aug. 2006.\*

(Continued)

*Primary Examiner*—Cathron C Brooks

*Assistant Examiner*—Austin Murphy

(74) *Attorney, Agent, or Firm*—Edwin A. Sisson, LLC; Michelle Christeon

(57) **CLAIM**

The ornamental design for a magnetic bookmark, as shown and described.

**DESCRIPTION**

FIG. 1 is a perspective view of a magnetic bookmark showing our new design;

FIG. 2 is a perspective view showing the magnetic bookmark as it appears on the page of a book thereof;

FIG. 3 is a top plan view thereof;

FIG. 4 is a front view thereof;

FIG. 5 is rear view thereof;

FIG. 6 is a left-side view thereof, the right-side being a mirror image; and

FIG. 7 is a bottom plan view thereof;

FIG. 8 is a perspective view of a second magnetic bookmark showing our new design;

FIG. 9 is a perspective view showing the second magnetic bookmark as it appears on the page of a book thereof;

FIG. 10 is a top plan view thereof;

FIG. 11 is a front view thereof;

FIG. 12 is rear view thereof;

FIG. 13 is a left-side view thereof, the right-side being a mirror image; and,

FIG. 14 is a bottom plan view thereof.

The broken lines form no part of the claimed design.

**1 Claim, 2 Drawing Sheets**

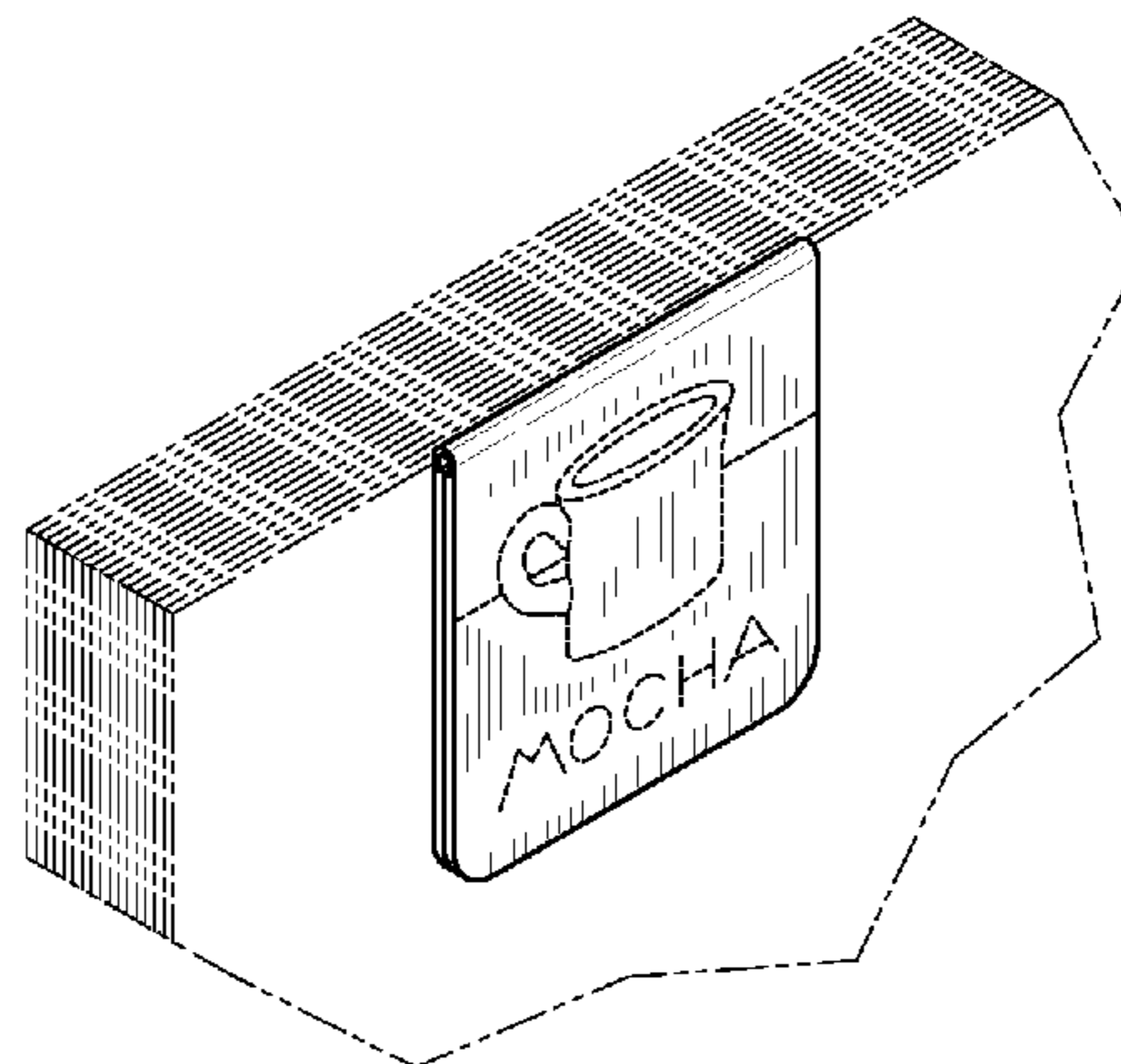
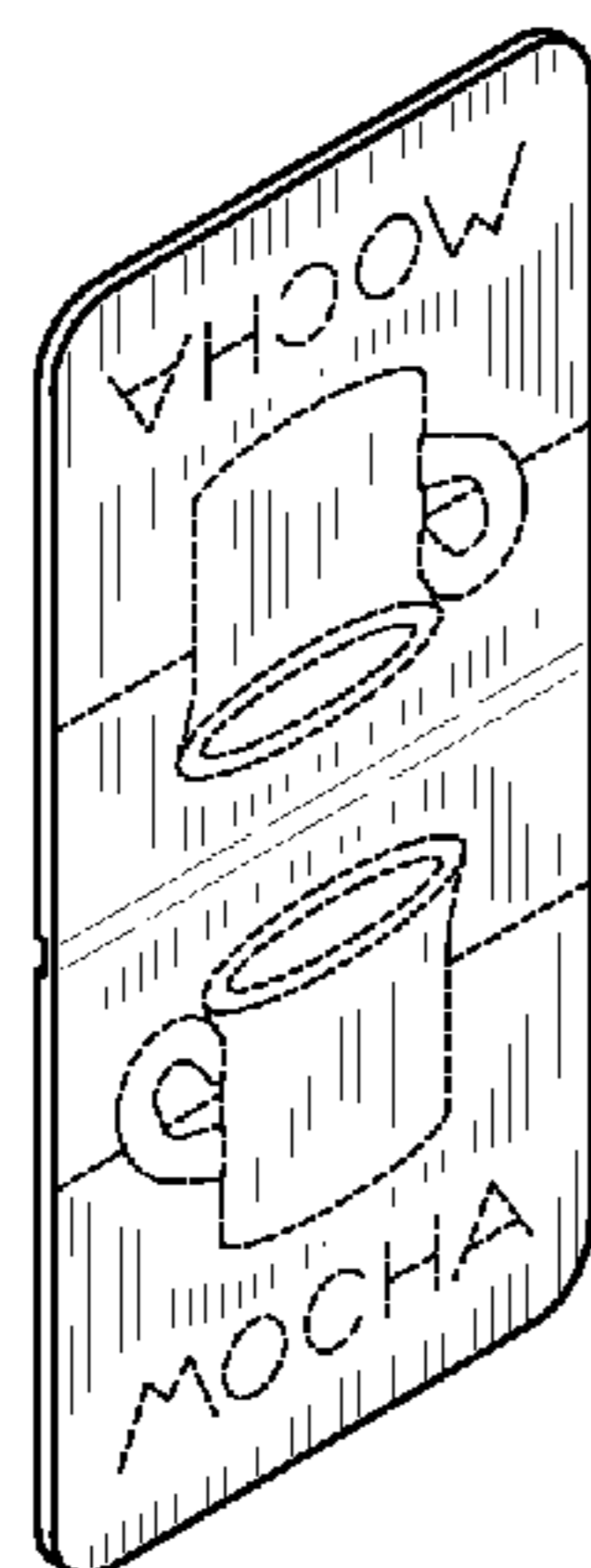

# US D616,493 S

Page 2

## U.S. PATENT DOCUMENTS

6,203,070	B1 *	3/2001	Richardson	283/117	D582,474	S *	12/2008	Phillips et al.	D19/10
6,205,947	B1 *	3/2001	Drew	116/235	D597,132	S *	7/2009	McDevitt	D19/34
D474,235	S *	5/2003	Haas	D19/10	D597,597	S *	8/2009	Alexander	D19/34
D476,683	S *	7/2003	Kilburn	D19/34	2004/0045496	A1 *	3/2004	Smith	116/234
D494,223	S *	8/2004	Best et al.	D20/27	2006/0101621	A1 *	5/2006	Just	24/67 R
D504,159	S *	4/2005	Best et al.	D20/27	2009/0083954	A1 *	4/2009	Hoggan	24/563
D518,100	S *	3/2006	Salander et al.	D19/26					
7,040,051	B2 *	5/2006	Windorski	40/641					
7,055,861	B1 *	6/2006	Lee	281/42					
D551,705	S	9/2007	Mershon						
D553,354	S *	10/2007	Kohler et al.	D3/247					
D566,184	S *	4/2008	Lau	D19/65					

## OTHER PUBLICATIONS

“Product Catalog”, “Ego Fashion Design Catalog”, 2006, p. 13 Publisher: Evarich International Enterprise Co. Ltd., Published in: Taiwan.

\* cited by examiner

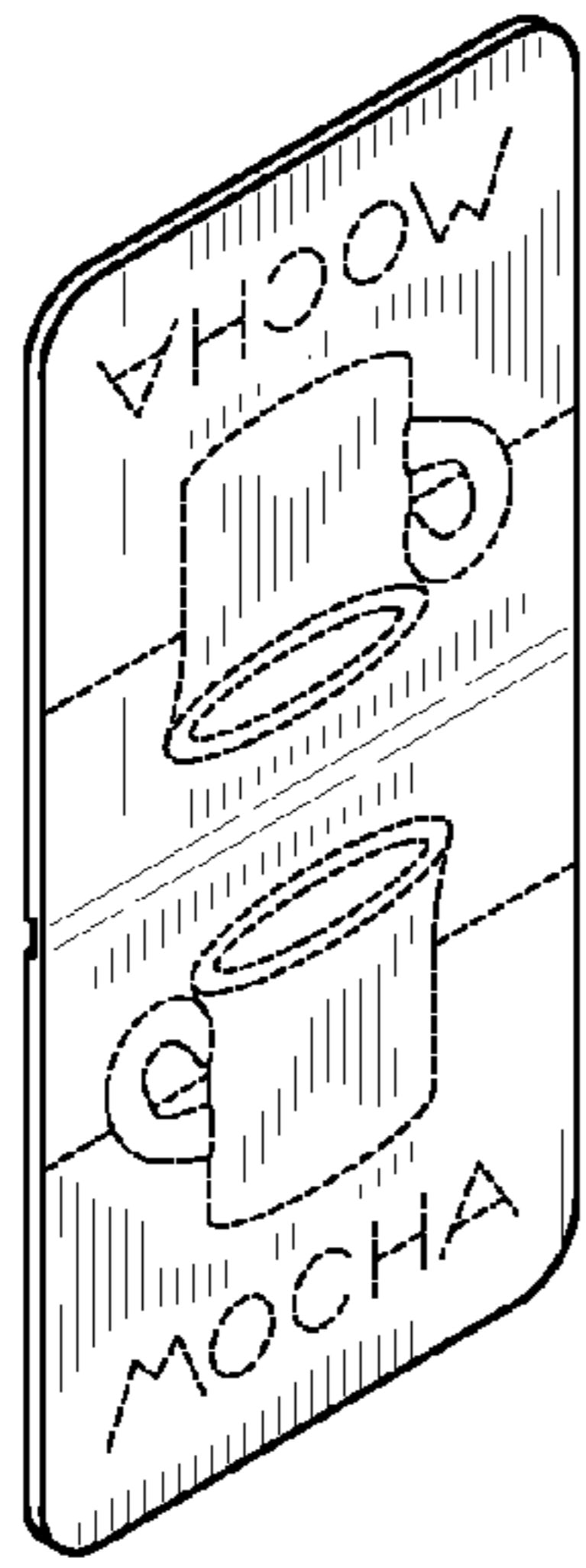

FIG-1

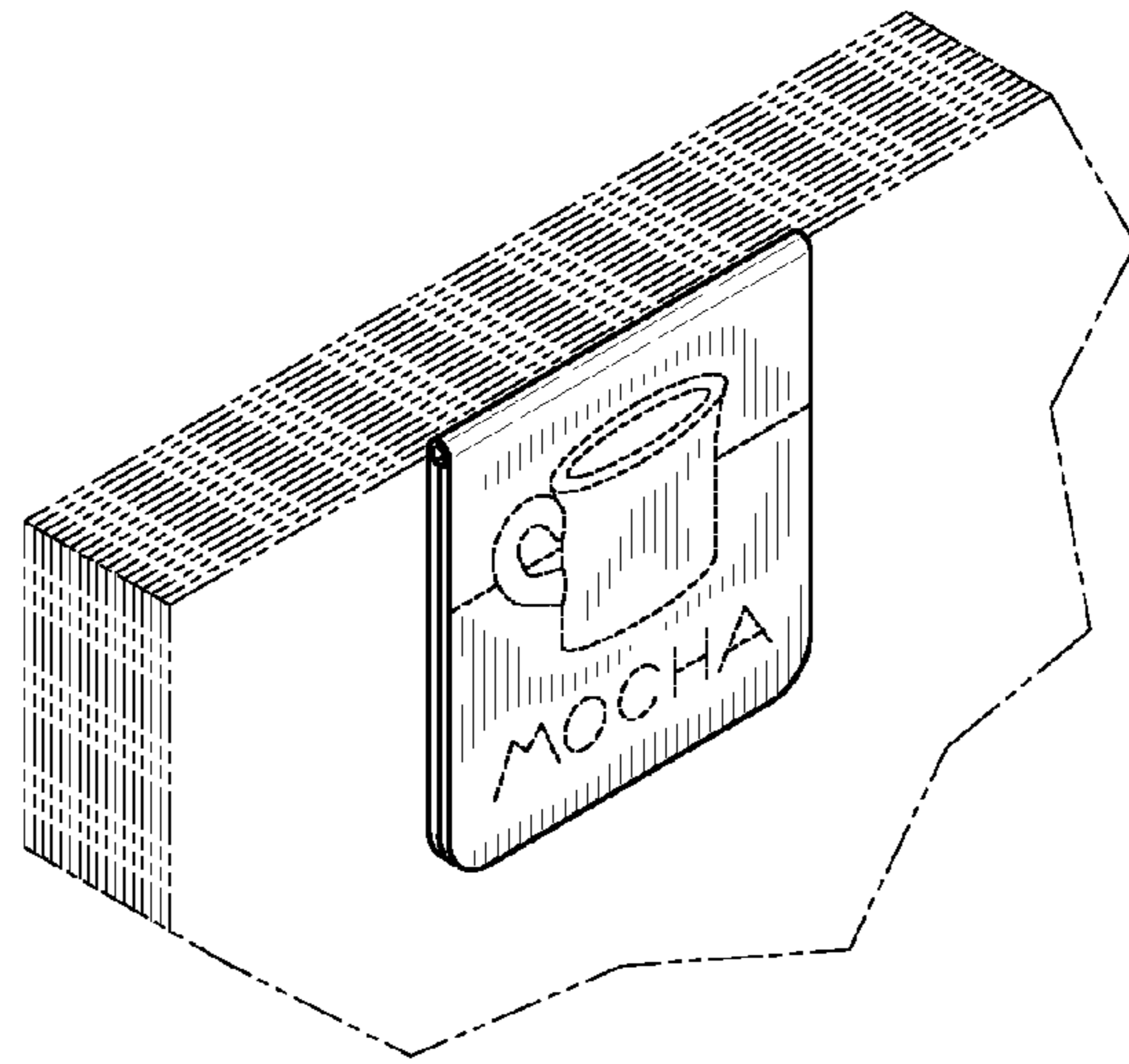

FIG-2

---

FIG-3

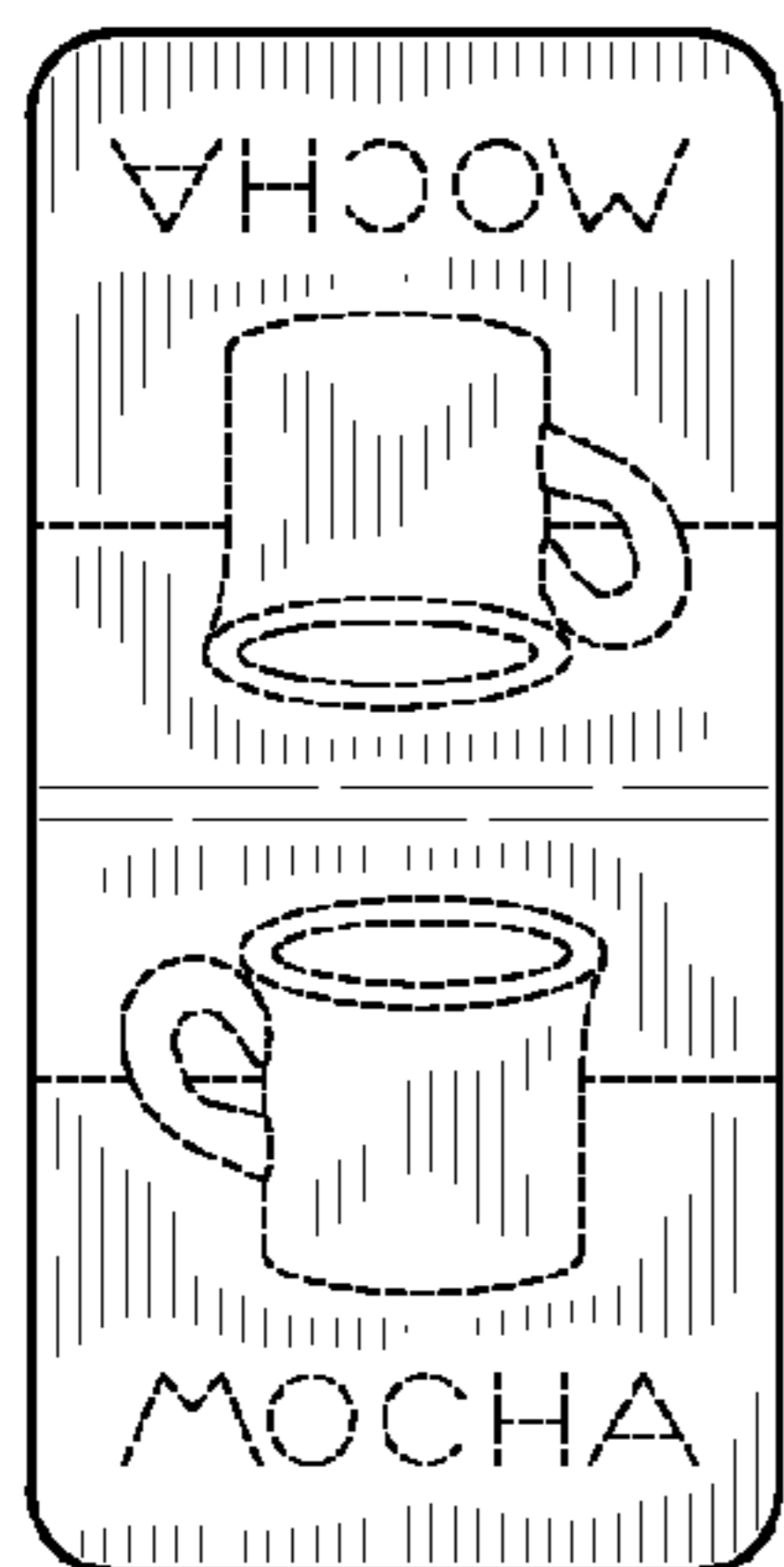

FIG-4

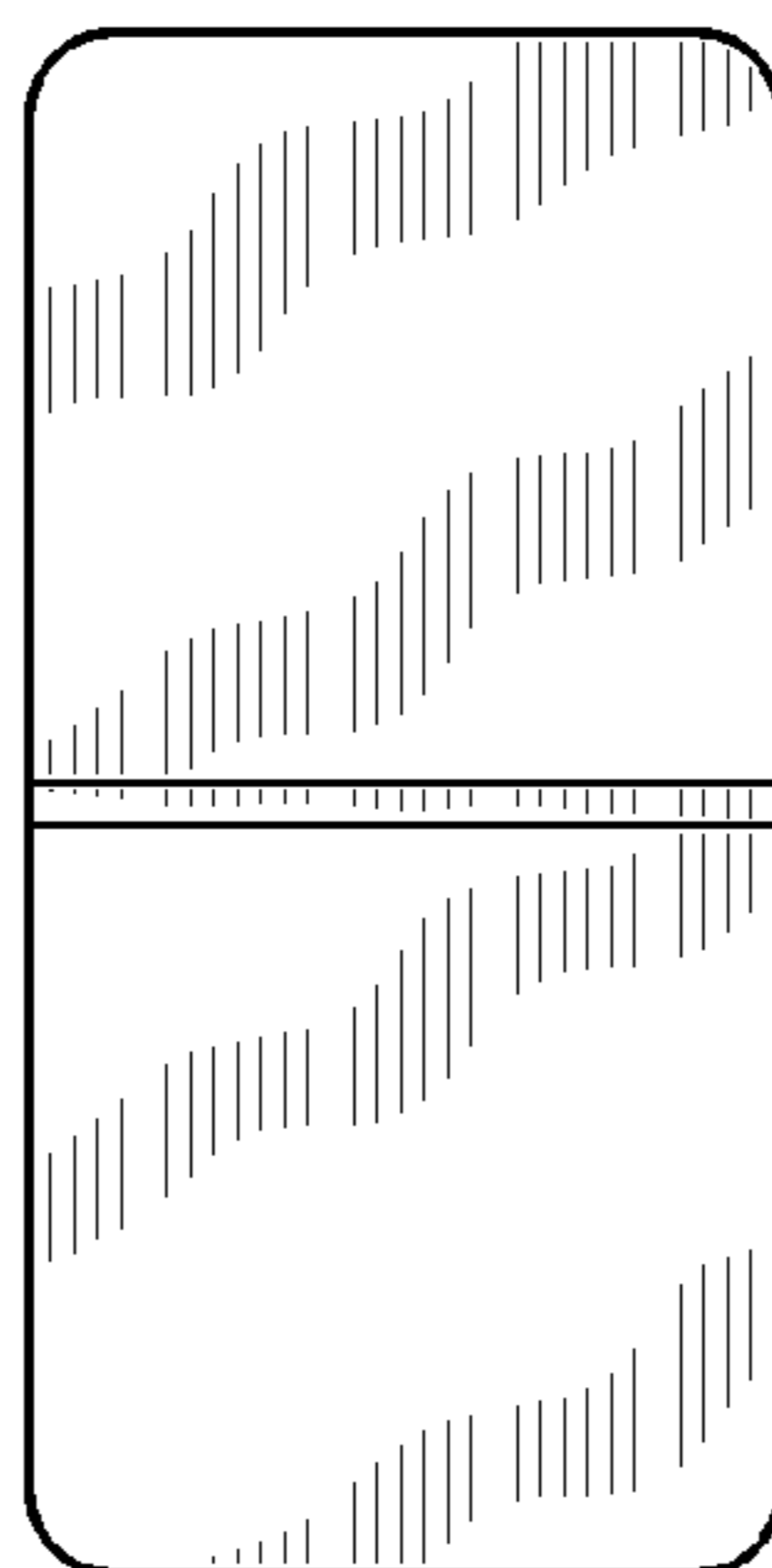

FIG-5



FIG-6

---

FIG-7

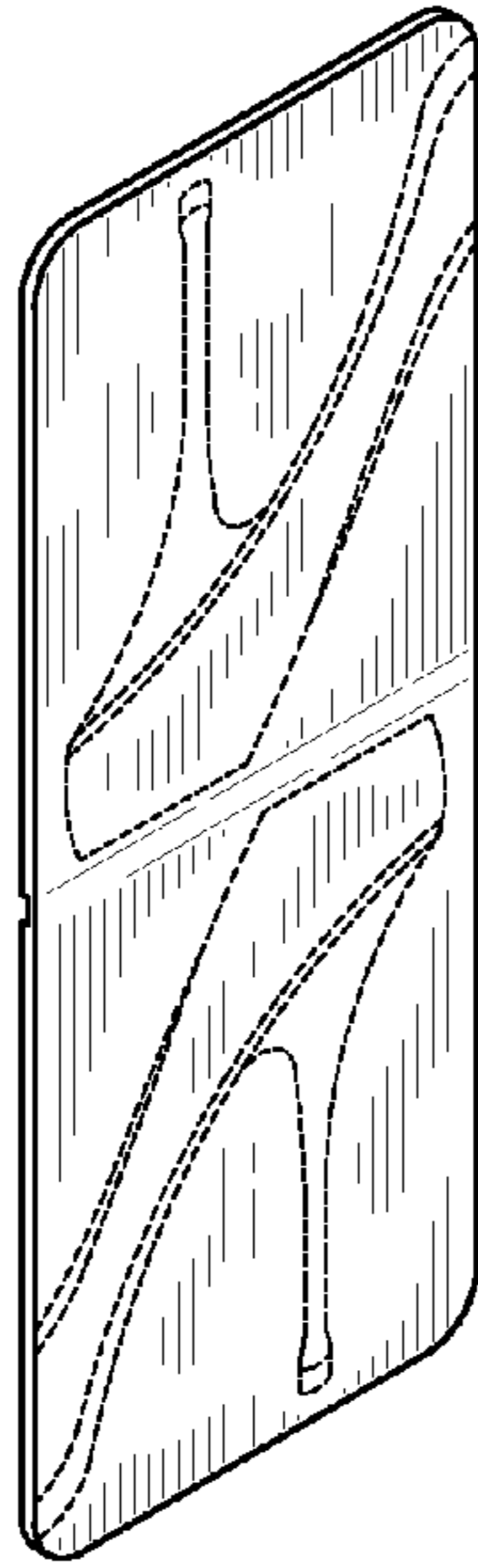

FIG-8

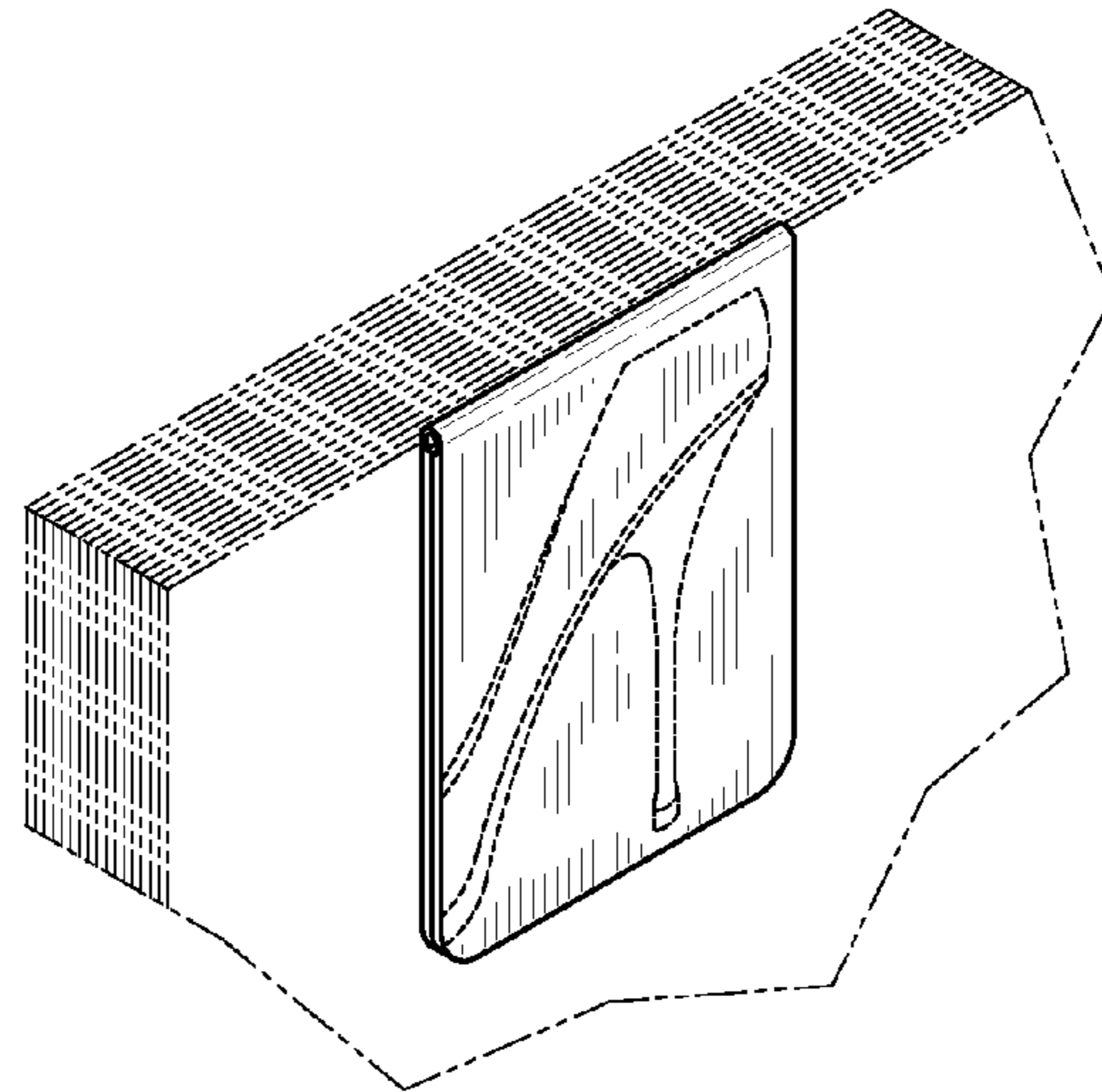

FIG-9

FIG-10

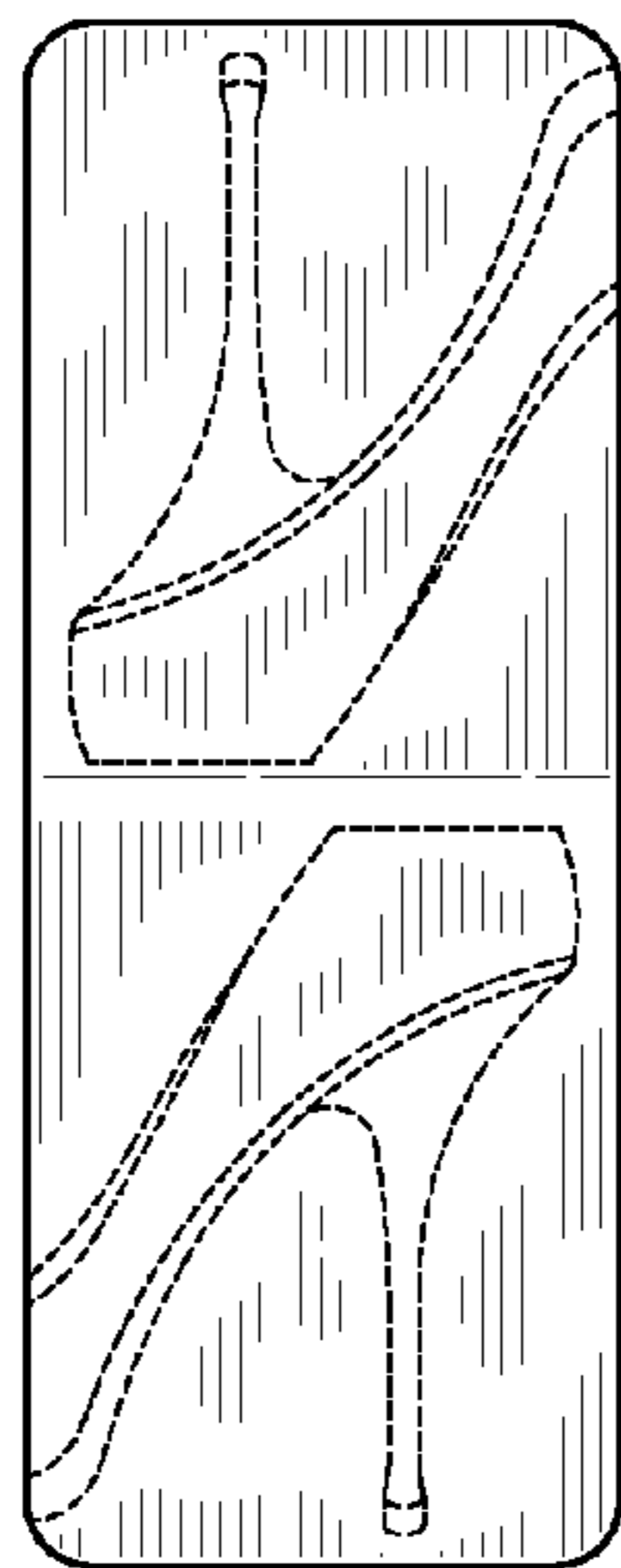

FIG-11

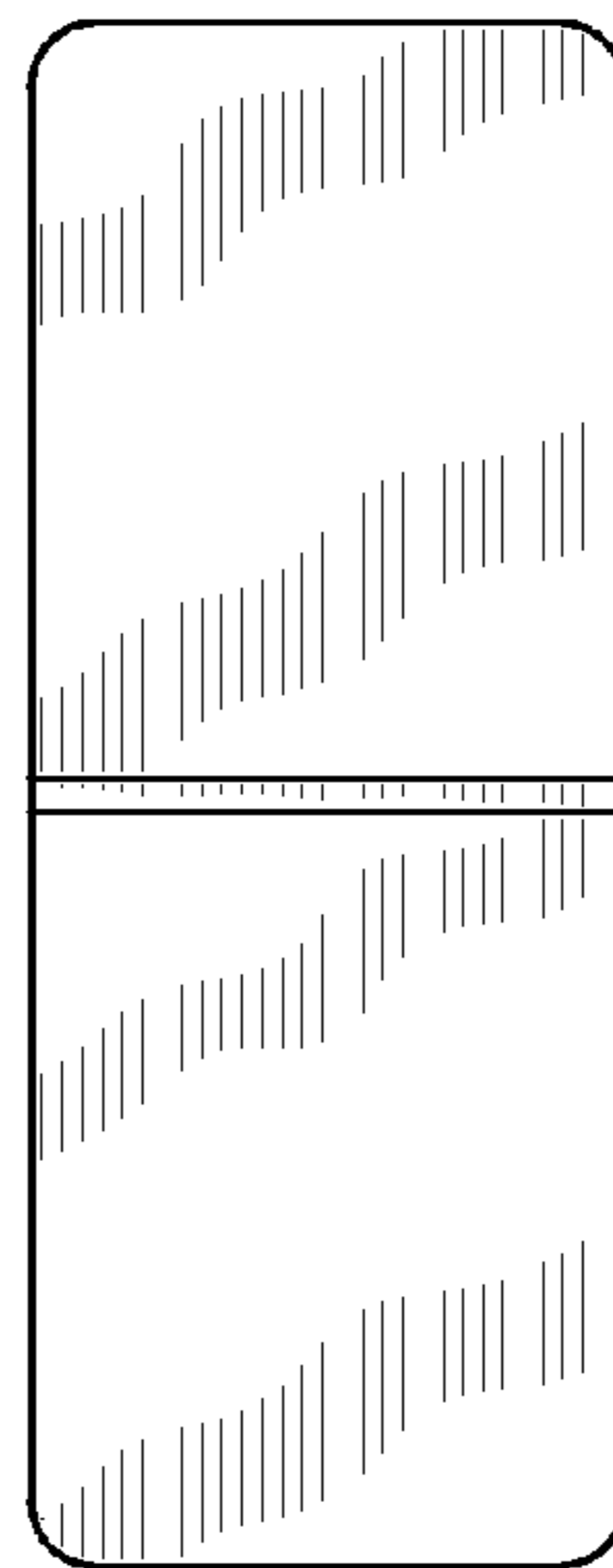

FIG-12



FIG-13

FIG-14