



US00D616445S

(12) **United States Design Patent**
Wong et al.

(10) **Patent No.:** **US D616,445 S**

(45) **Date of Patent:** **** May 25, 2010**

(54) **MOUSE**

(75) Inventors: **Kwok Fong Wong**, New Territories (CN); **Pui Yi Ching**, New Territories (CN)

(73) Assignee: **Shining Union Limited**, Tsuen Wan, New Territories, Hong Kong (CN)

(**) Term: **14 Years**

(21) Appl. No.: **29/316,399**

(22) Filed: **Sep. 21, 2009**

(30) **Foreign Application Priority Data**

Jul. 10, 2009 (HK) 0901091

(51) **LOC (9) Cl.** **14-02**

(52) **U.S. Cl.** **D14/402**

(58) **Field of Classification Search** D14/402-411, D14/356, 388, 389, 383-385, 417, 426; 345/156-167; 463/36-38; 358/471, 473

See application file for complete search history.

(56) **References Cited**

U.S. PATENT DOCUMENTS

D349,688 S * 8/1994 Holbrook D13/162

D372,908 S * 8/1996 Aeschbacher et al. D14/407

D375,729 S * 11/1996 Aeschbacher et al. D14/407

D507,573 S * 7/2005 Wang et al. D14/407

D563,252 S * 3/2008 Minta D10/104

D575,784 S * 8/2008 Chatterjee et al. D14/407

D593,093 S * 5/2009 Chatterjee et al. D14/402

D593,094 S * 5/2009 Chatterjee et al. D14/402

D593,095 S * 5/2009 Chatterjee et al. D14/402

* cited by examiner

Primary Examiner—Cathron C Brooks

Assistant Examiner—Austin Murphy

(74) *Attorney, Agent, or Firm*—Alix, Yale & Ristas, LLP

(57) **CLAIM**

The ornamental design for a mouse, as shown and described.

DESCRIPTION

FIG. 1 is a perspective view of a mouse showing our new design;

FIG. 2 is a top plan view thereof;

FIG. 3 is a bottom plan view thereof;

FIG. 4 is a front view thereof;

FIG. 5 is a rear view thereof;

FIG. 6 is a right side view thereof; and,

FIG. 7 is a left side view thereof.

1 Claim, 7 Drawing Sheets

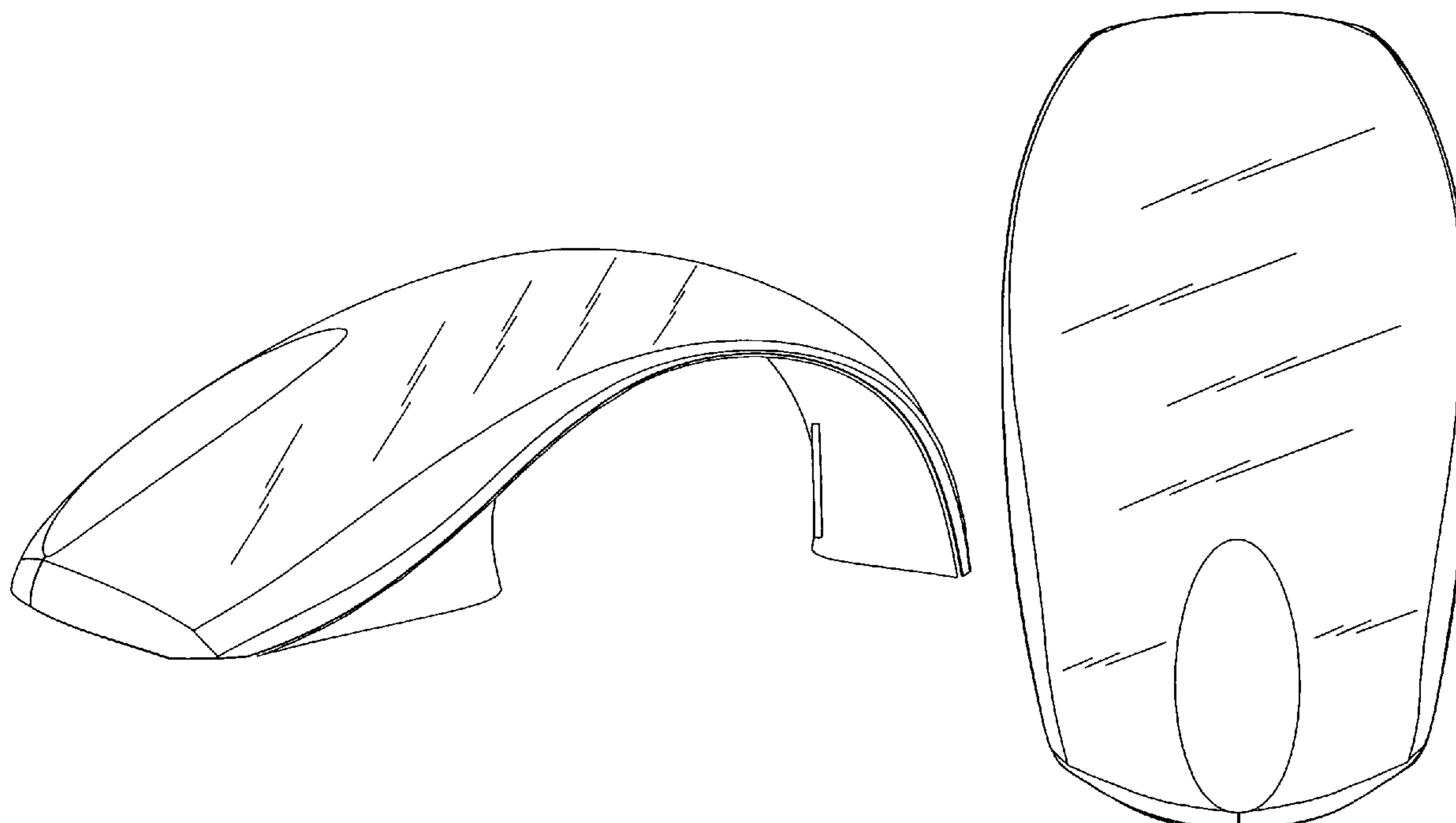

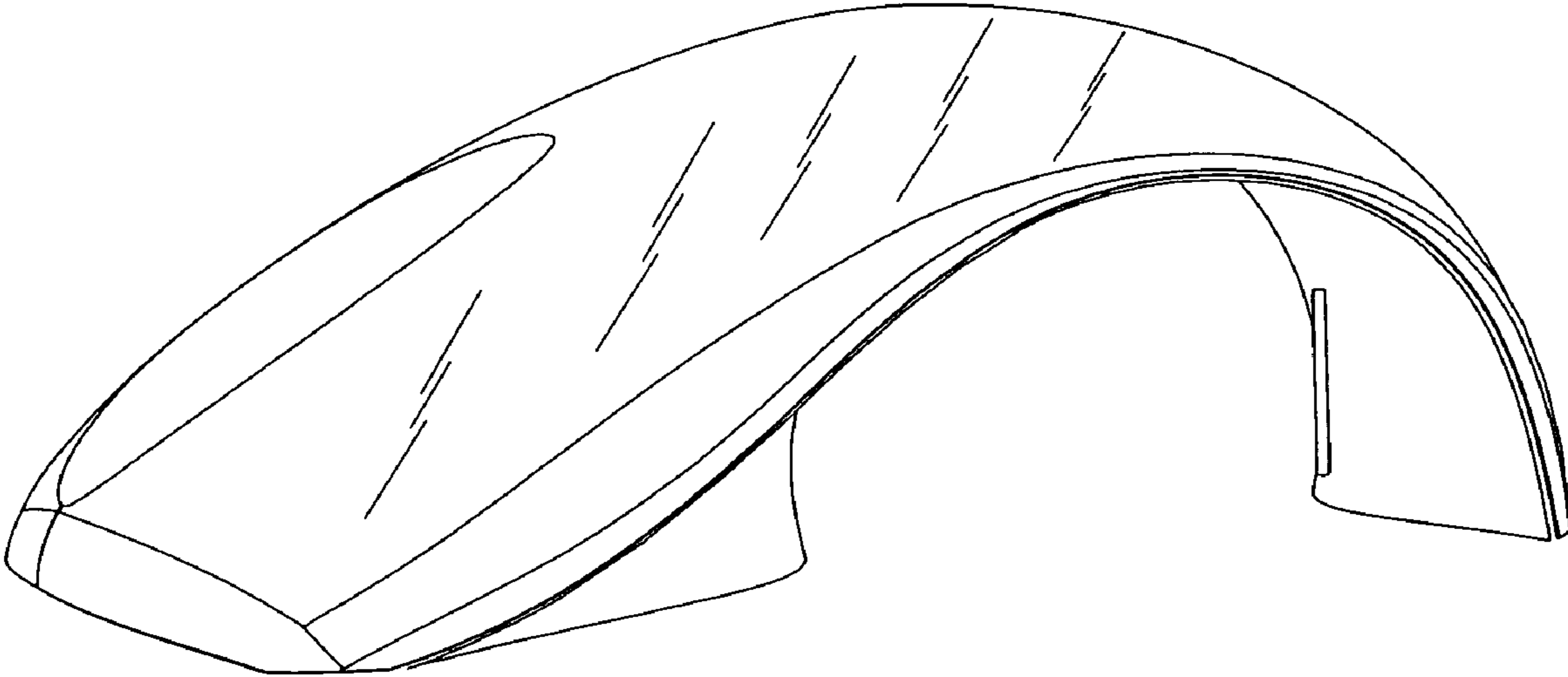

Fig. 1

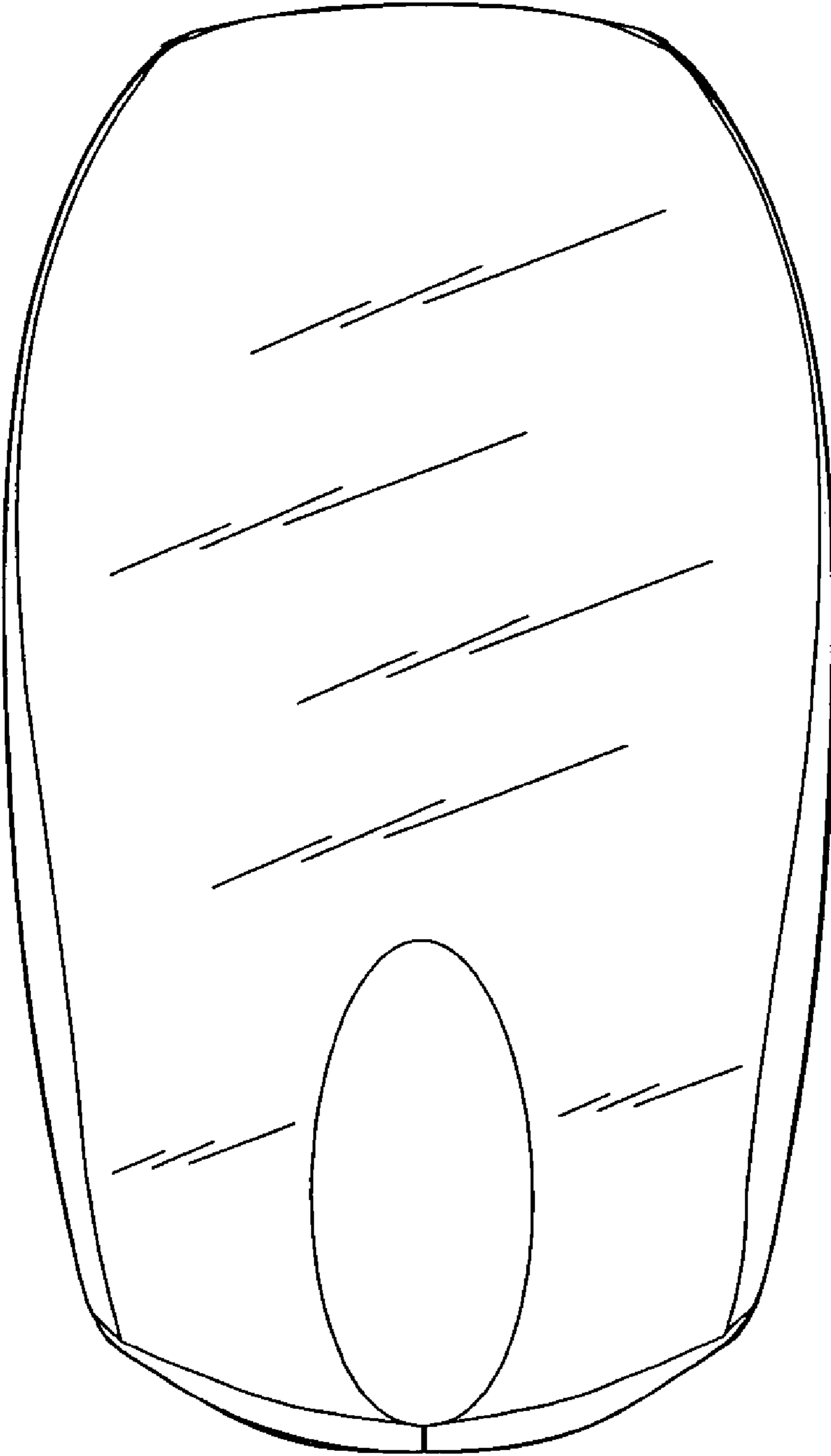

Fig. 2

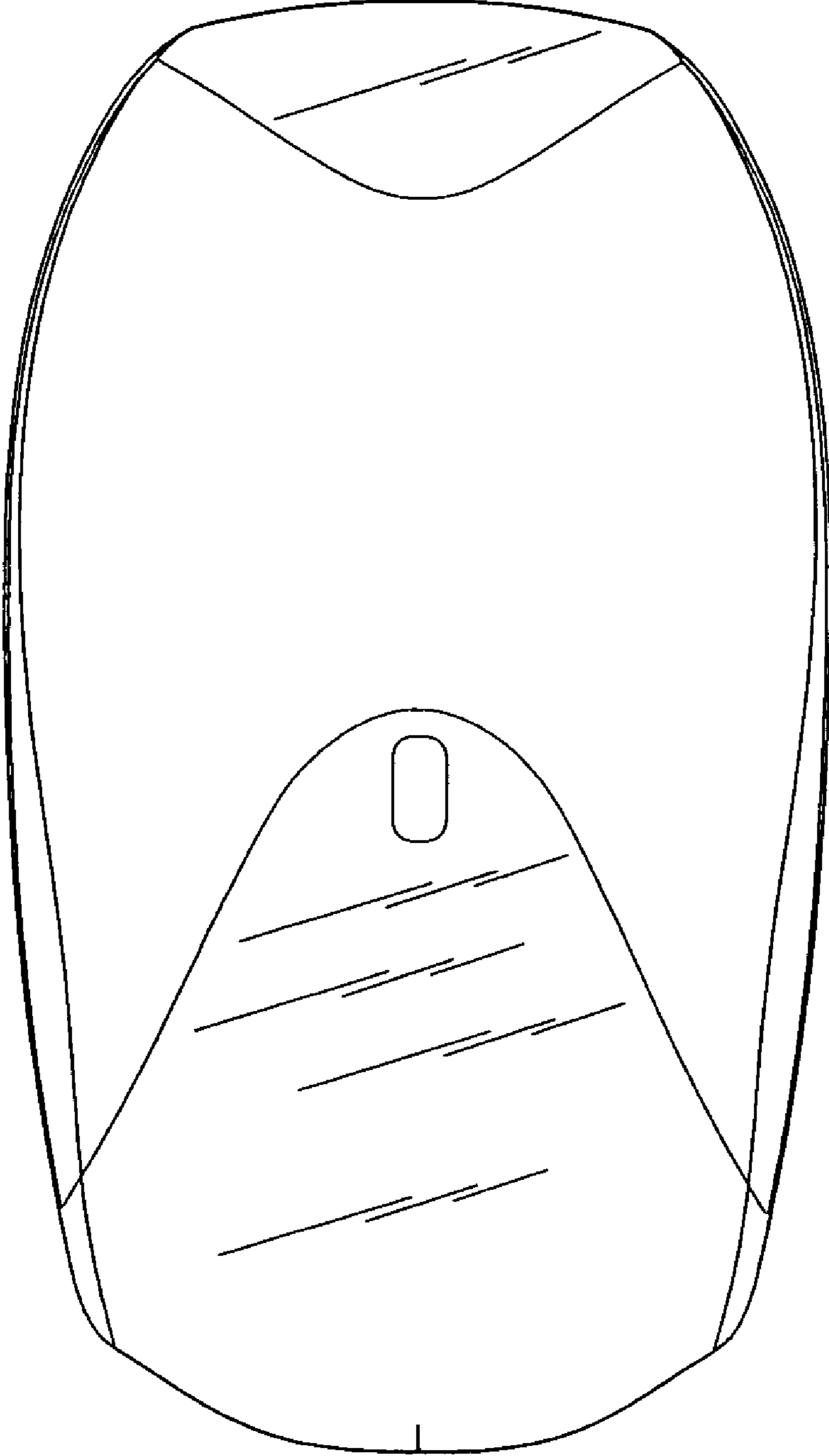

Fig. 3

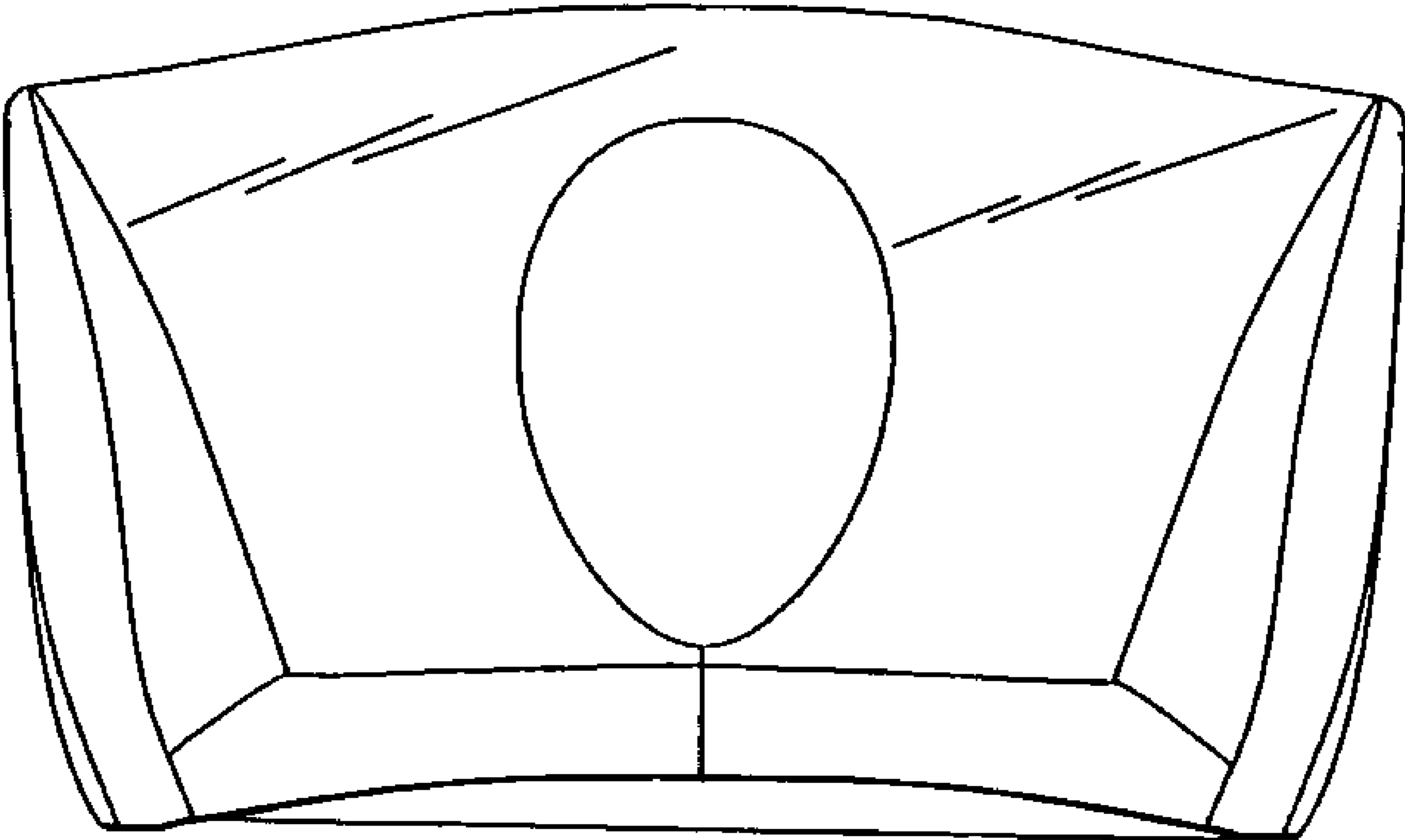

Fig. 4

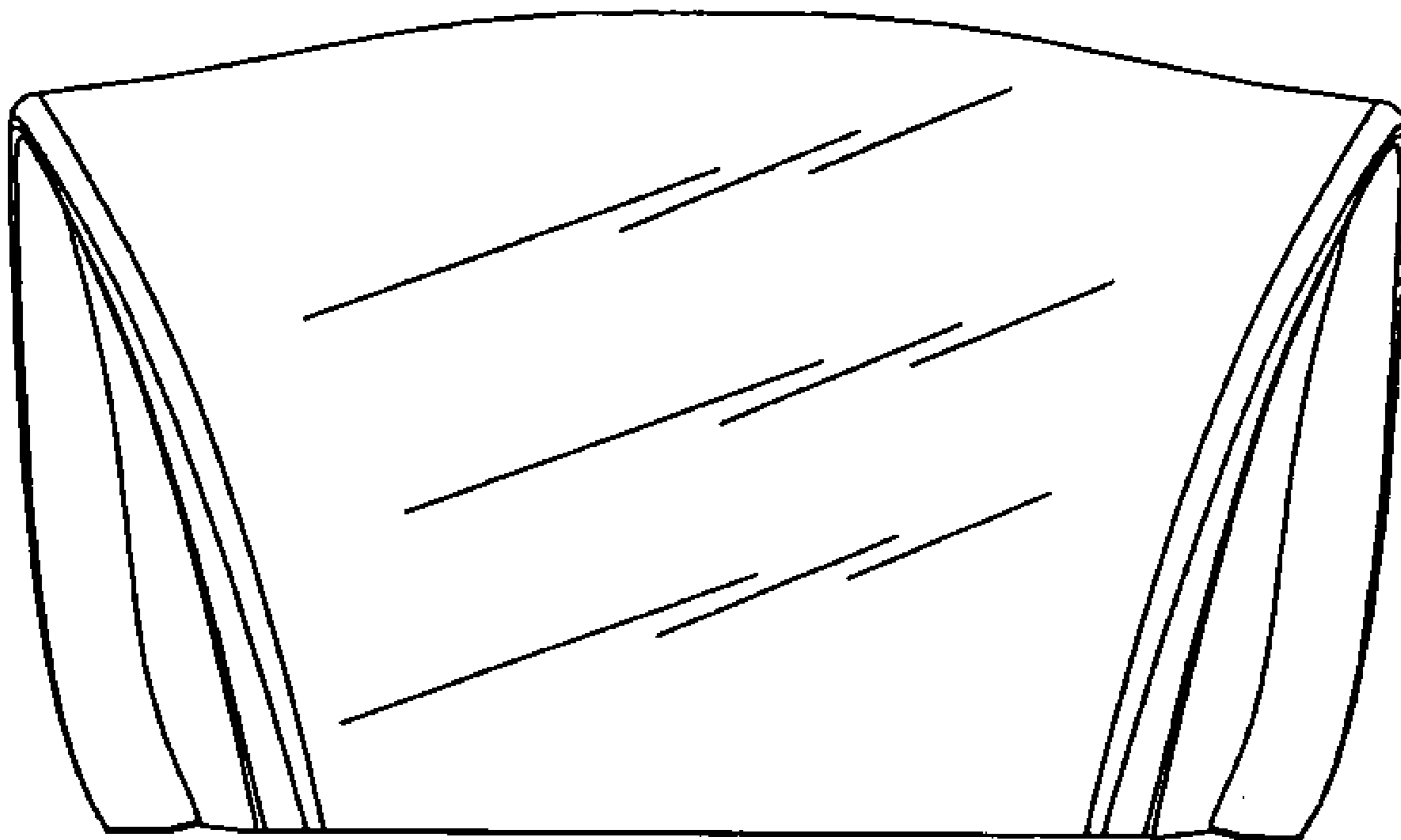

Fig. 5

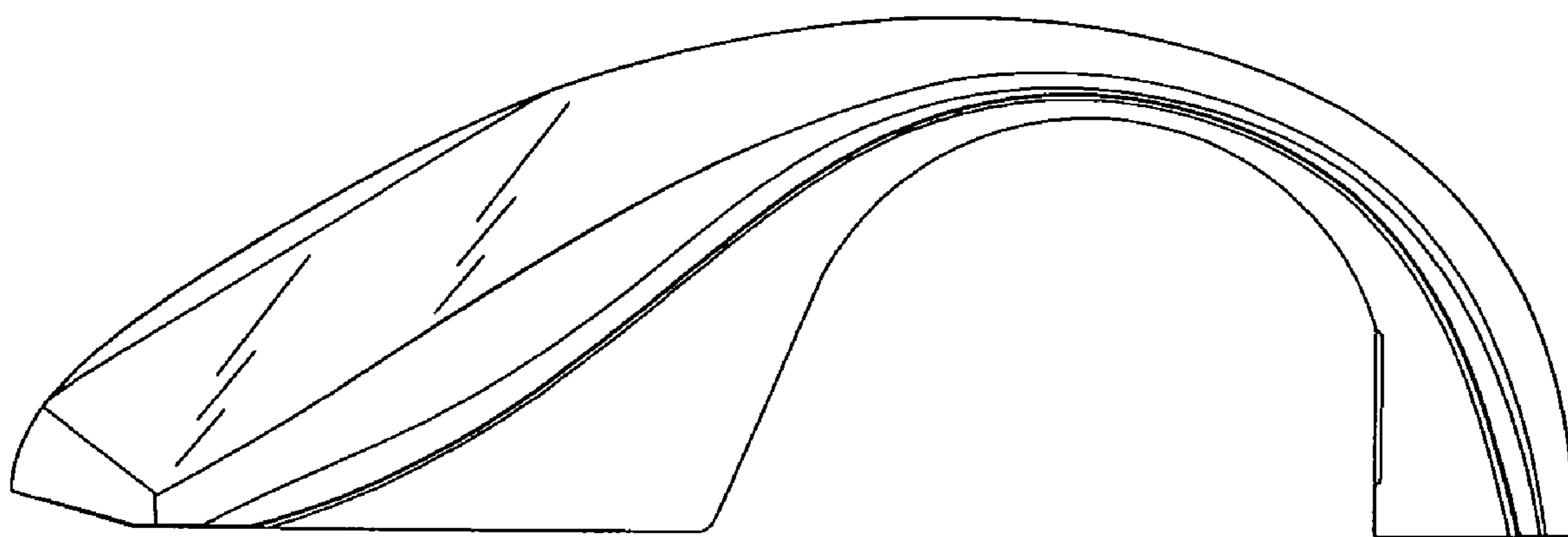

Fig. 6

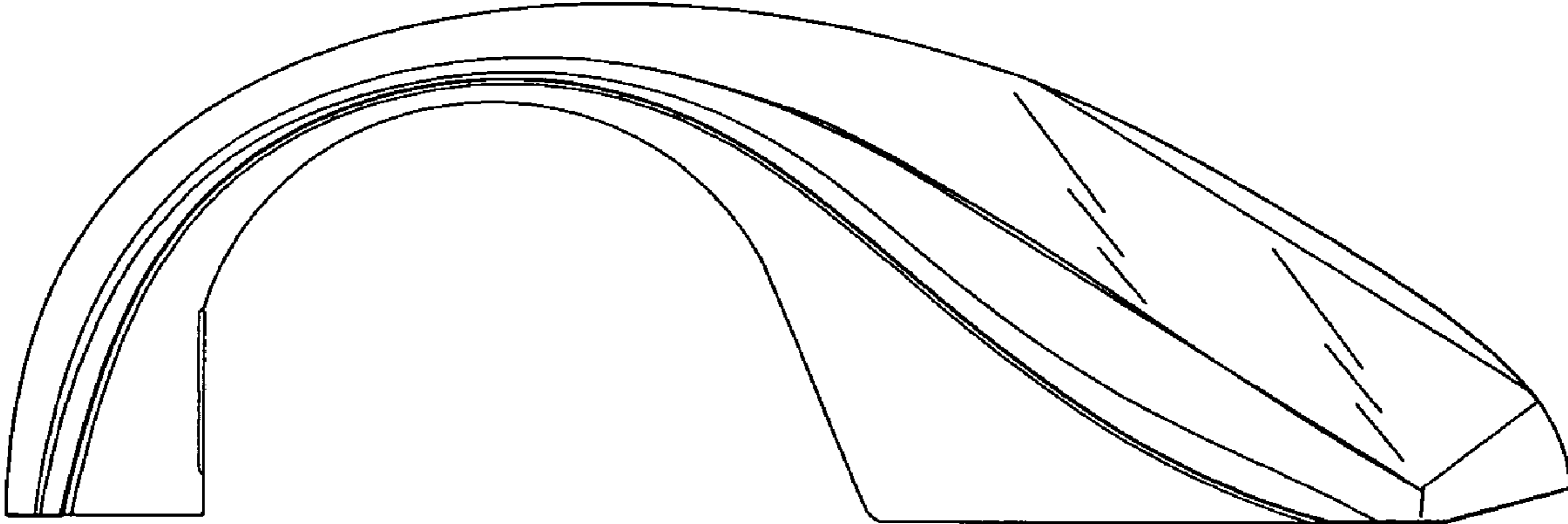

Fig. 7