



US00D616374S

(12) **United States Design Patent**
McNutt et al.

(10) **Patent No.:** **US D616,374 S**
(45) **Date of Patent:** **** May 25, 2010**

(54) **PATCH PANEL**

(75) Inventors: **Patrick S. McNutt**, Carnation, WA
(US); **Edward R. Burns**, Kirkland, WA
(US)

(73) Assignee: **Leviton Manufacturing Co., Inc.**, Little
Neck, NY (US)

(**) Term: **14 Years**

(21) Appl. No.: **29/325,400**

(22) Filed: **Sep. 30, 2008**

(51) **LOC (9) Cl.** **13-03**

(52) **U.S. Cl.** **D13/154; D13/184; D13/177**

(58) **Field of Classification Search** D13/133,
D13/146, 147, 154, 177, 184, 199; 439/344,
439/379, 535, 536, 538, 571, 540.1, 541.1,
439/57, 638, 650, 676; D14/240, 256, 299
See application file for complete search history.

(56) **References Cited**

U.S. PATENT DOCUMENTS

D359,475 S * 6/1995 Coffey D13/154
D411,514 S * 6/1999 Tulley D13/154
D411,515 S * 6/1999 Tulley D13/154

2009/0053923 A1* 2/2009 Navarro et al. 439/489

* cited by examiner

Primary Examiner—Daniel D Bui

Assistant Examiner—Thomas J Johannes

(74) *Attorney, Agent, or Firm*—Davis Wright Tremaine LLP;
George C. Rondeau, Jr.

(57) **CLAIM**

The ornamental design for a patch panel, as shown and
described.

DESCRIPTION

FIG. 1 is a top left, front perspective view of a patch panel
showing our new design.

FIG. 2 is a front elevational view thereof.

FIG. 3 is a rear elevational view thereof.

FIG. 4 is a right side elevational view thereof.

FIG. 5 is a left side elevational view thereof.

FIG. 6 is a top plan view thereof; and,

FIG. 7 is a bottom plan view thereof.

The broken lines are for illustrative purposes only and form
no part of the claimed design.

1 Claim, 5 Drawing Sheets

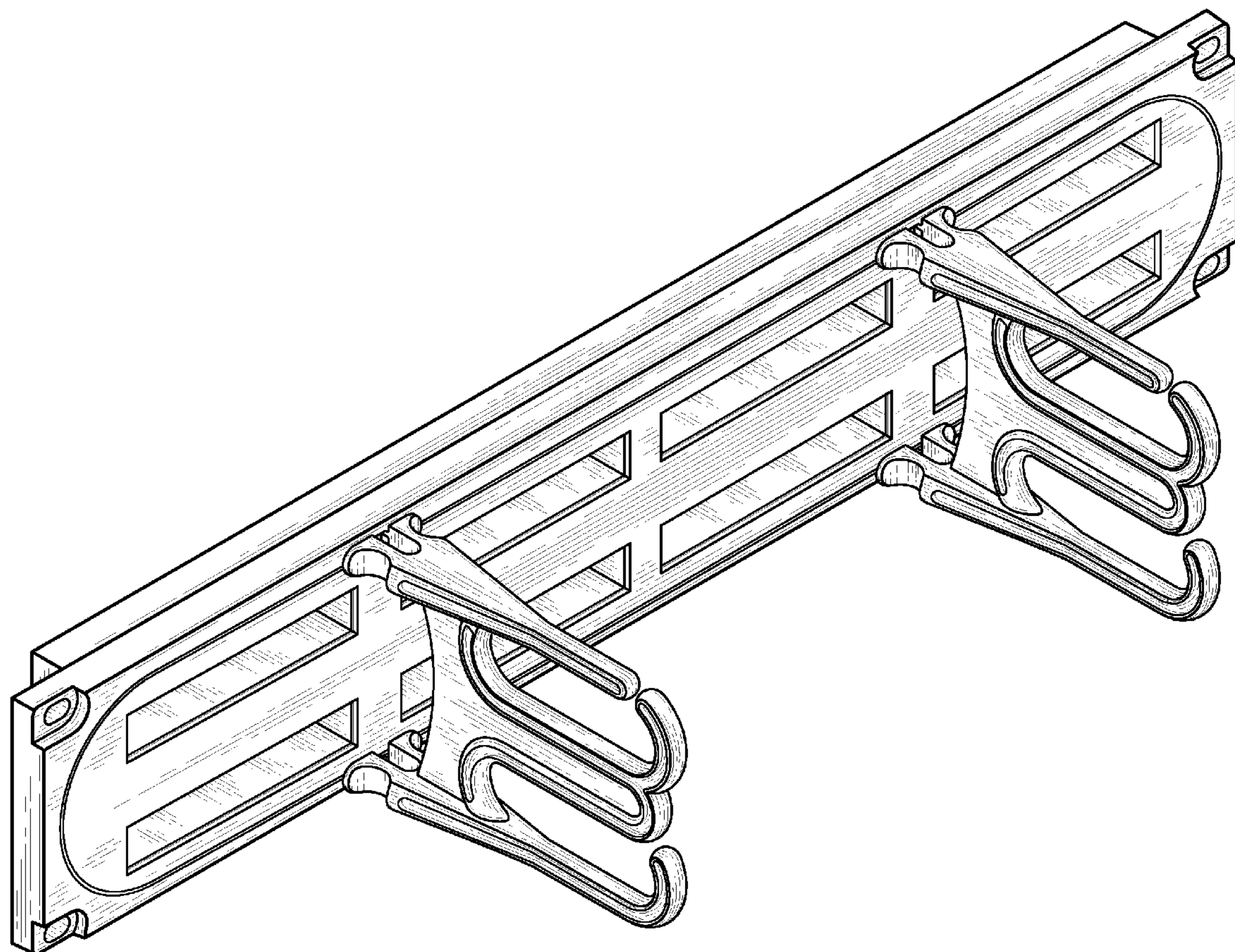

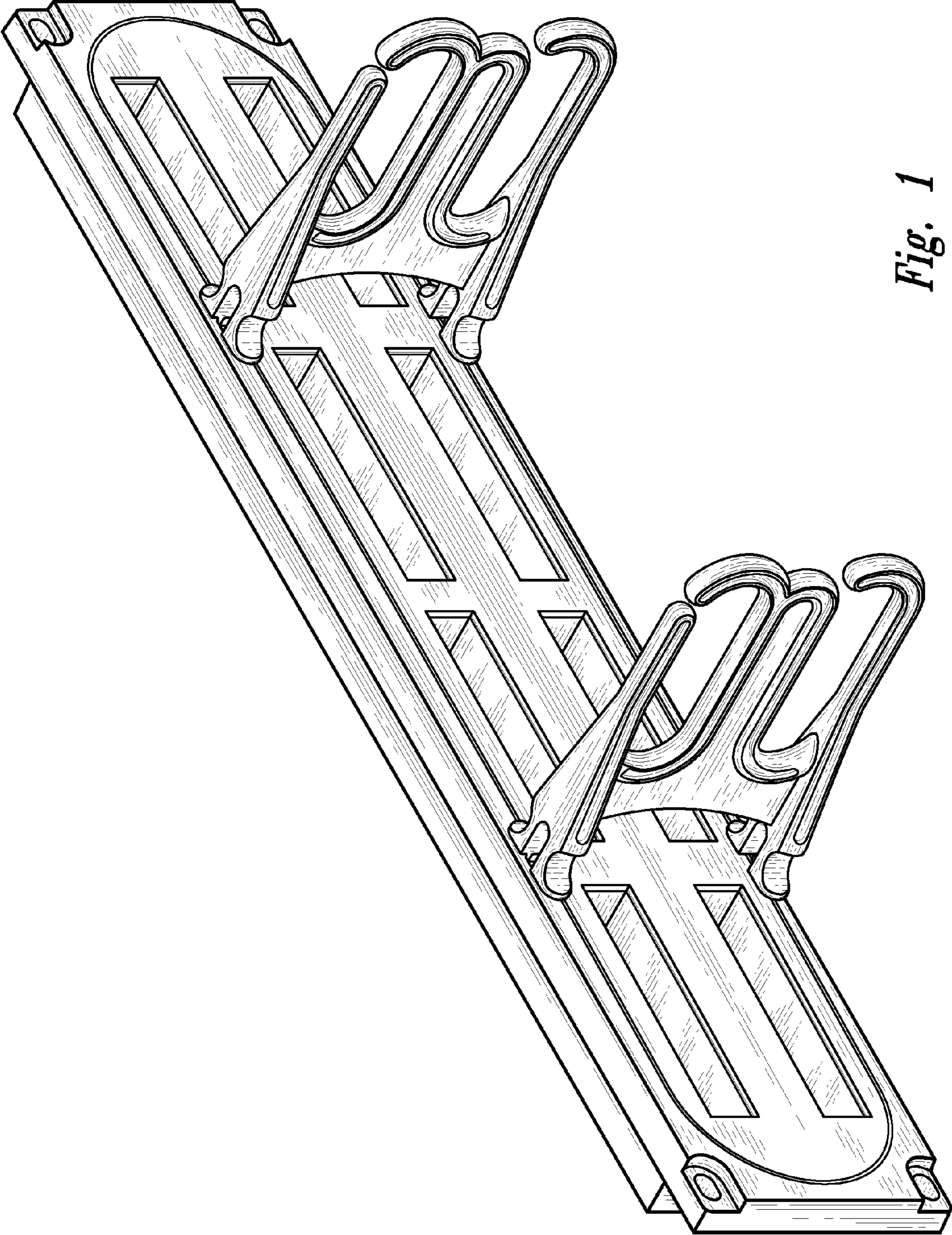

Fig. 1

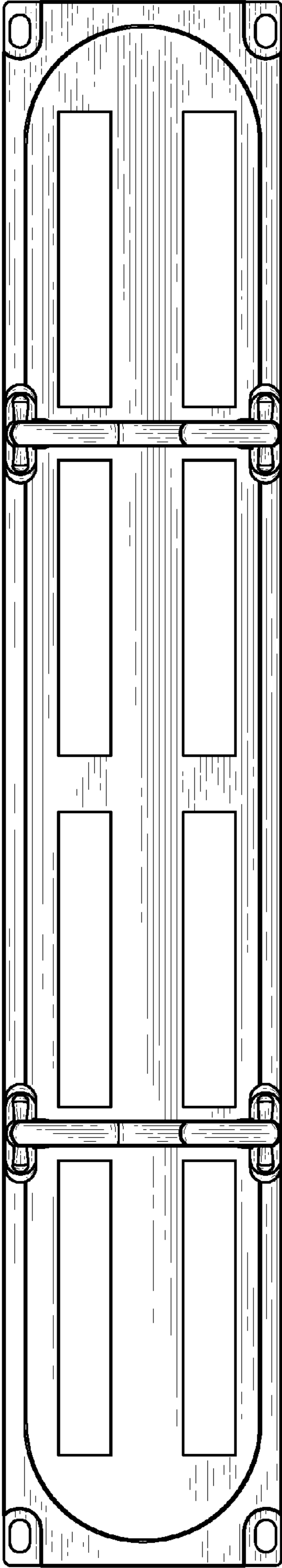

Fig. 2

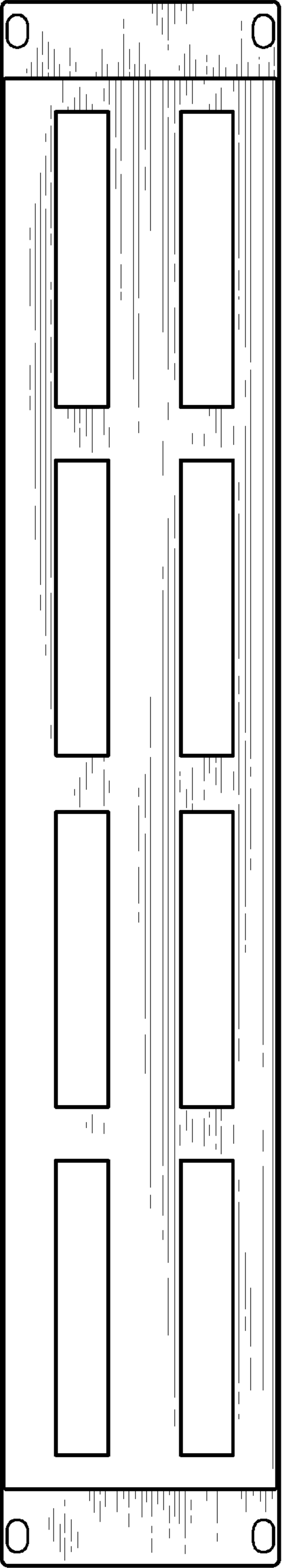

Fig. 3

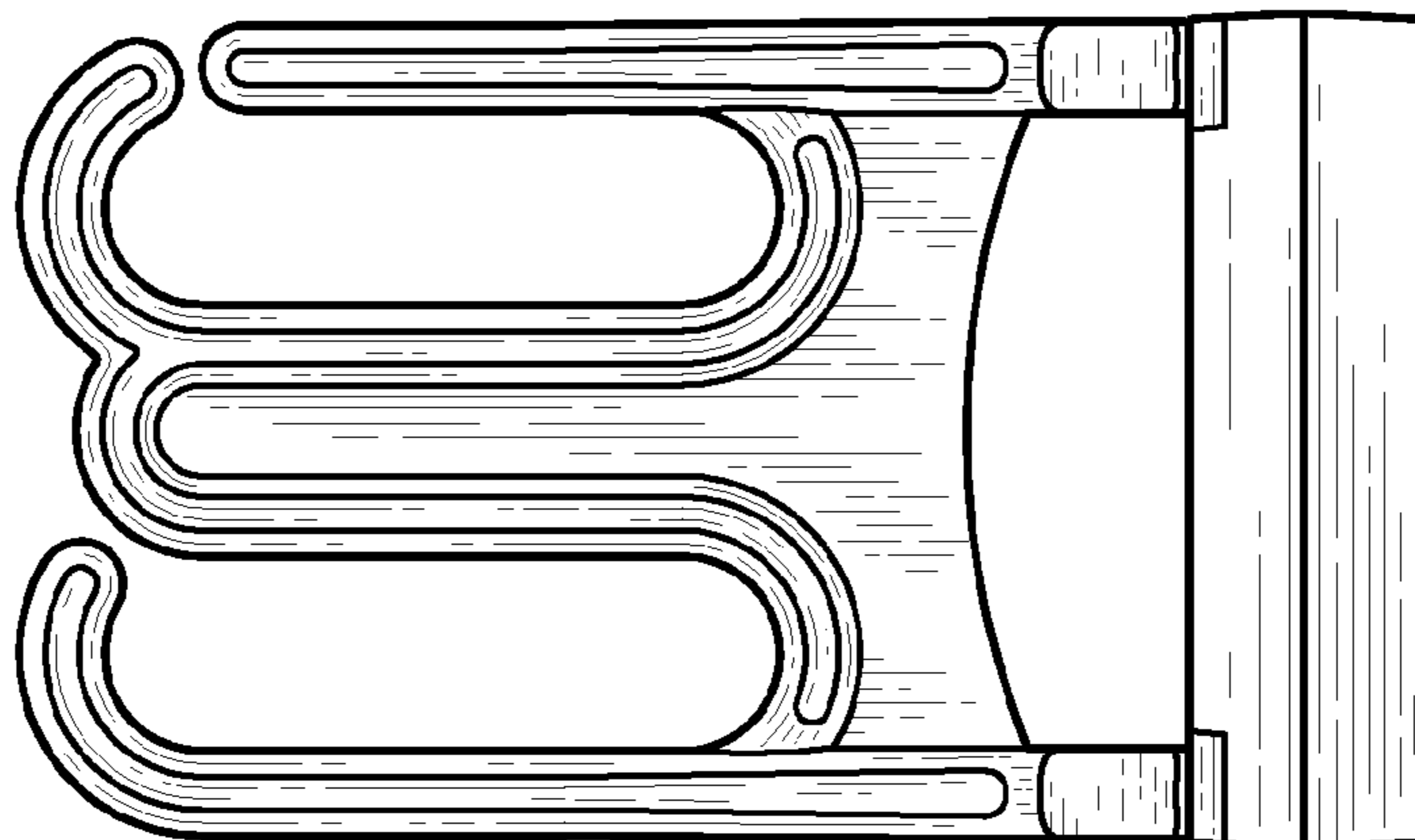

Fig. 4

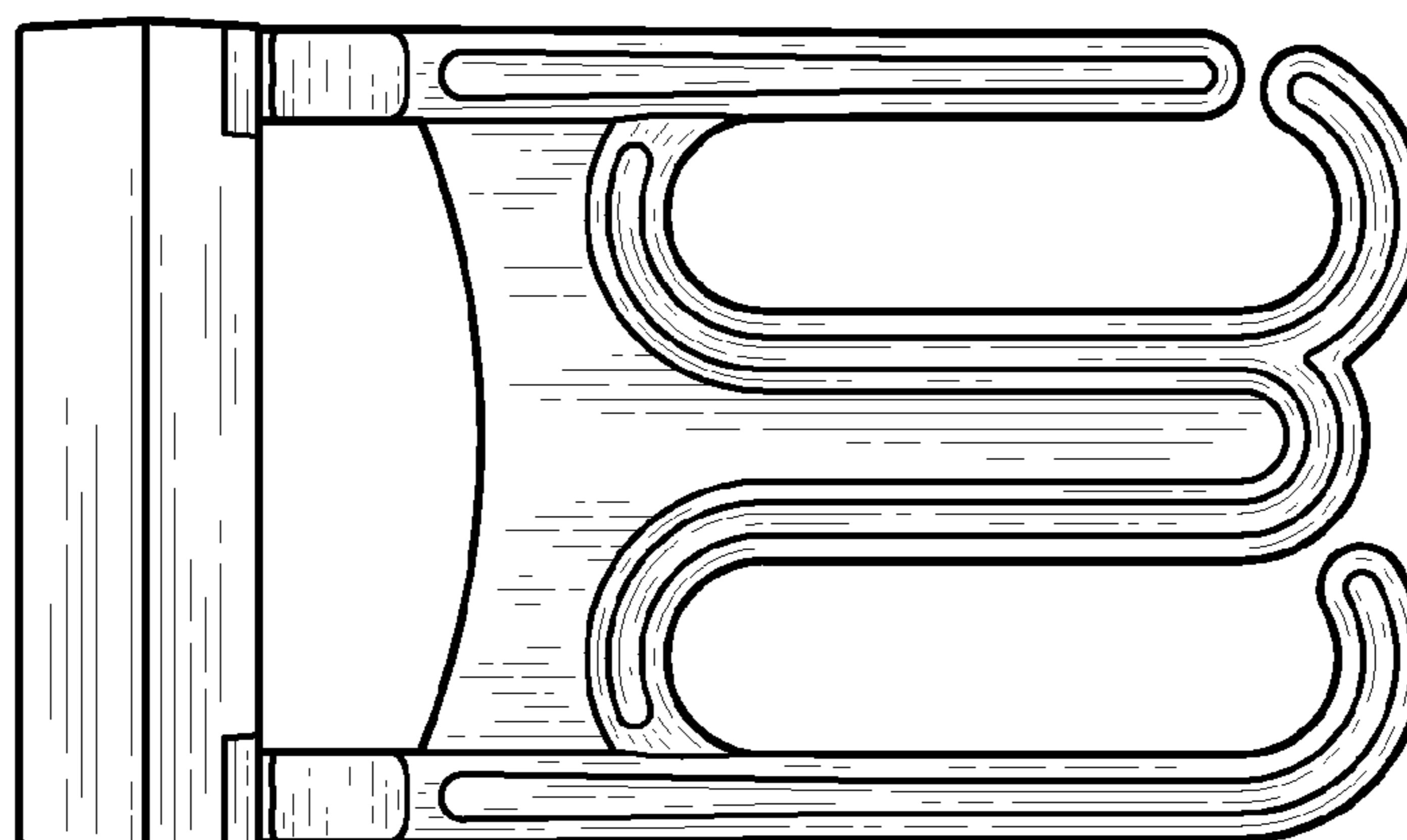

Fig. 5

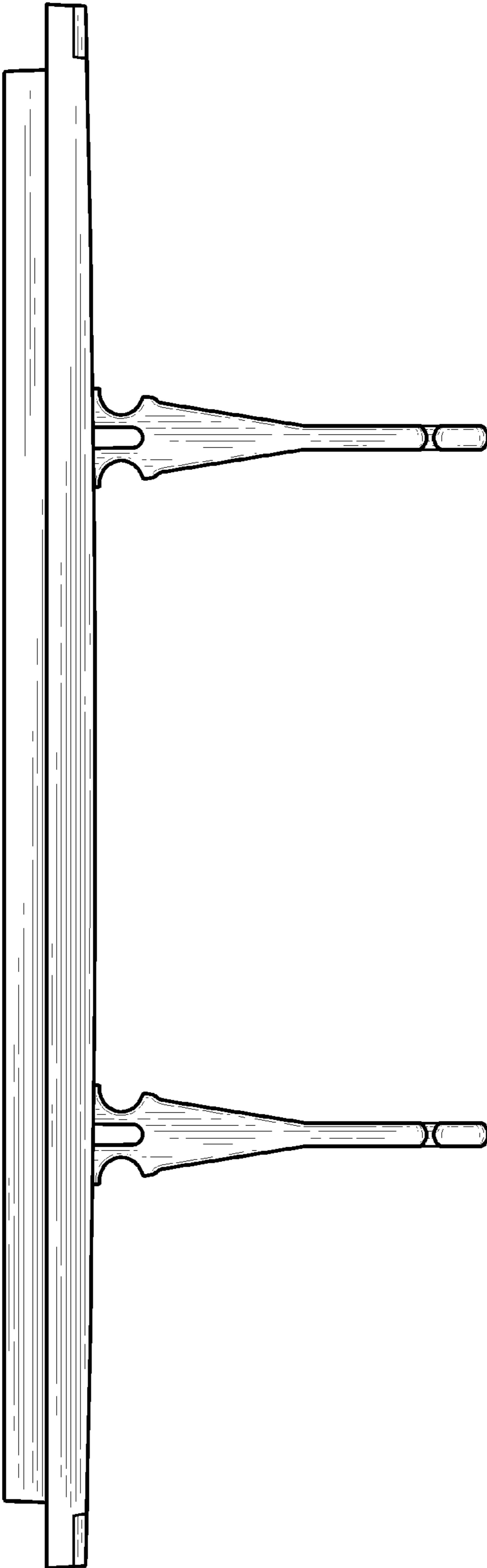

Fig. 6

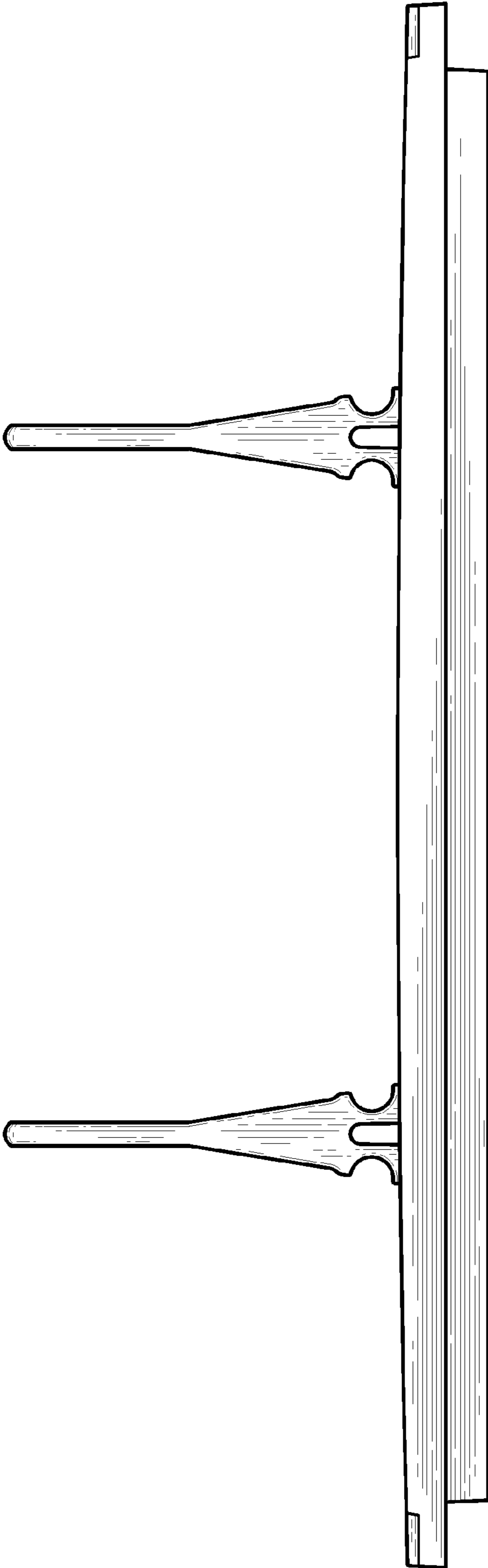

Fig. 7